

Introduction

N09200102114

Thank you for buying a MITSUBISHI LANCER SPORTBACK.

We are confident you will enjoy your vehicle. It has been engineered for optimum performance, durability and comfort. By thoroughly reading this Owner's Manual, you will gain an understanding of the many features that are included in the LANCER SPORTBACK. The Owner's Manual contains descriptions and illustrations that will assist in the operation and maintenance of your vehicle.

Your Authorized Mitsubishi Motors Dealer will be happy to assist you with any further questions you may have regarding the operation of your vehicle.

Please note that this manual applies to all LANCER SPORTBACK models and explains all features including options. Some features explained in this manual may not be installed on your vehicle.

Please leave this Owner's Manual in the vehicle at the time of resale. The next owner will appreciate having access to the information contained here.

This manual includes instructions for standard and optional equipment available at the time of printing. Mitsubishi Motors Corporation reserves the right to make changes in design and specifications and to make additions or improvements in its product without assuming any obligation to install these on previously manufactured products.



Throughout this manual the words **WARNING** and **CAUTION** appear.

These are reminders to be especially careful. Failure to follow the instructions could result in personal injury or damage to your vehicle.

WARNING

Indicates a strong possibility of severe personal injury or death if instructions are not followed.

CAUTION

Points out hazards or unsafe practices that could cause minor personal injury or damage to your vehicle.

You will see another important symbol:

NOTE Gives helpful information.

WARNING

- **Engine exhaust, some of its constituents, and certain vehicle components contain or emit chemicals known to the State of California to cause cancer and birth defects and reproductive harm. In addition, certain fluids contained in vehicles and certain products of component wear contain or emit chemicals known to the State of California to cause cancer and birth defects or other reproductive harm.**



N09348201032

NOTE

Name of Owner	Date of Purchase
Address of Owner	Model of Vehicle
Name and Address of Dealer	Vehicle Identification Number

Maintenance record

Service Performed	Date	Kilometers Miles	Inspection and Maintenance Item

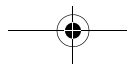

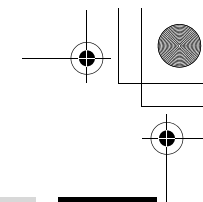
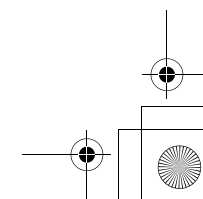
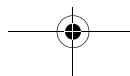
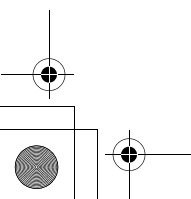
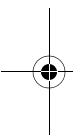

Table of contents

Overview	1
Quick index	2
General information	3
Seat and restraint systems	4
Features and controls	5
Driving safety	6
Comfort controls	7
For emergencies	8
Vehicle care and maintenance	9
Customer assistance/Reporting Safety Defects	10
Specifications	11
Alphabetical index	12



Instruments and controls (Driver's area)

1 Instruments and controls (Driver's area)

N00100202603

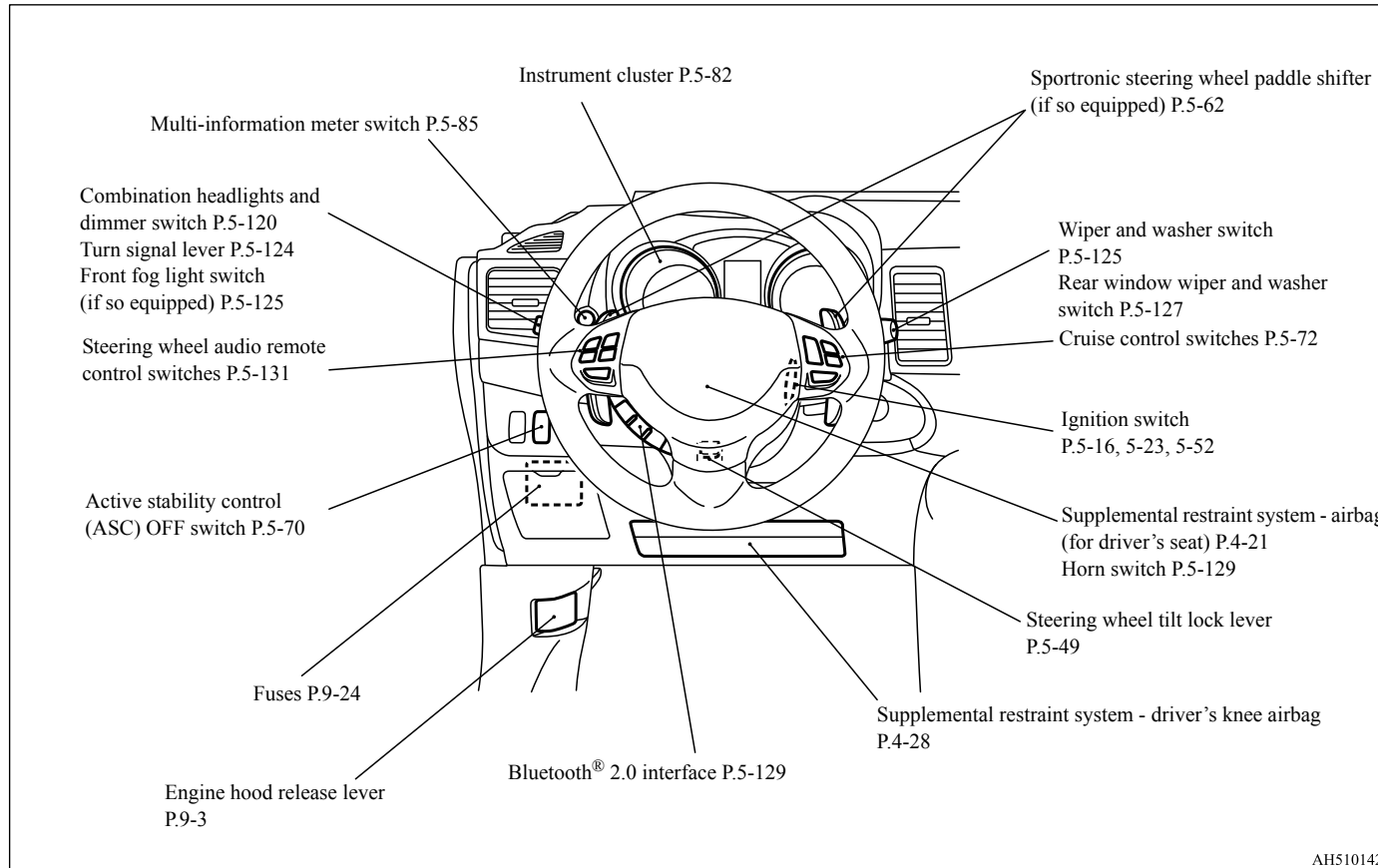

AH5101422

1-1 Overview

Instruments and controls

1

N00100202687

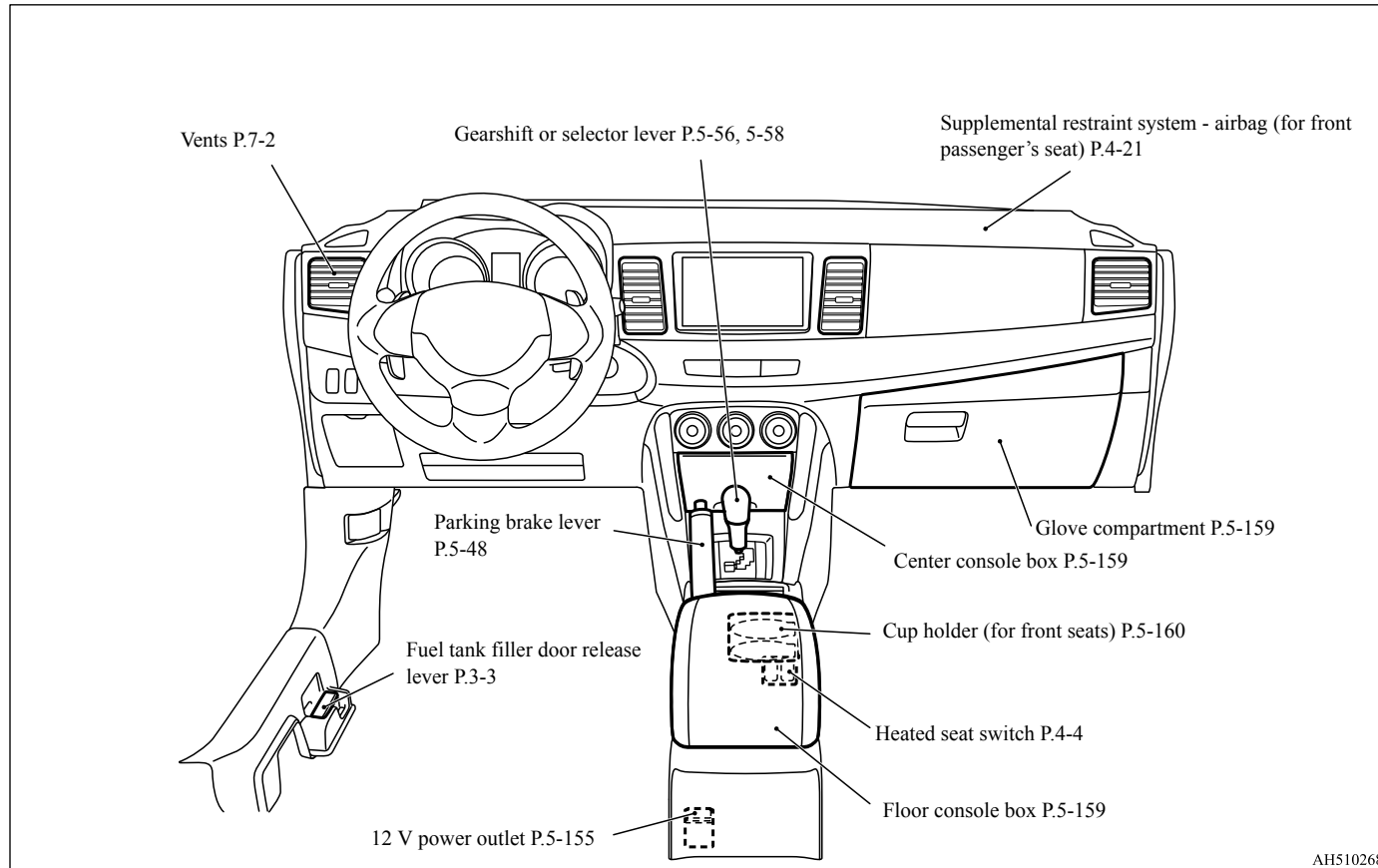

AH5102689

Center panel

1 Center panel

N00100701252

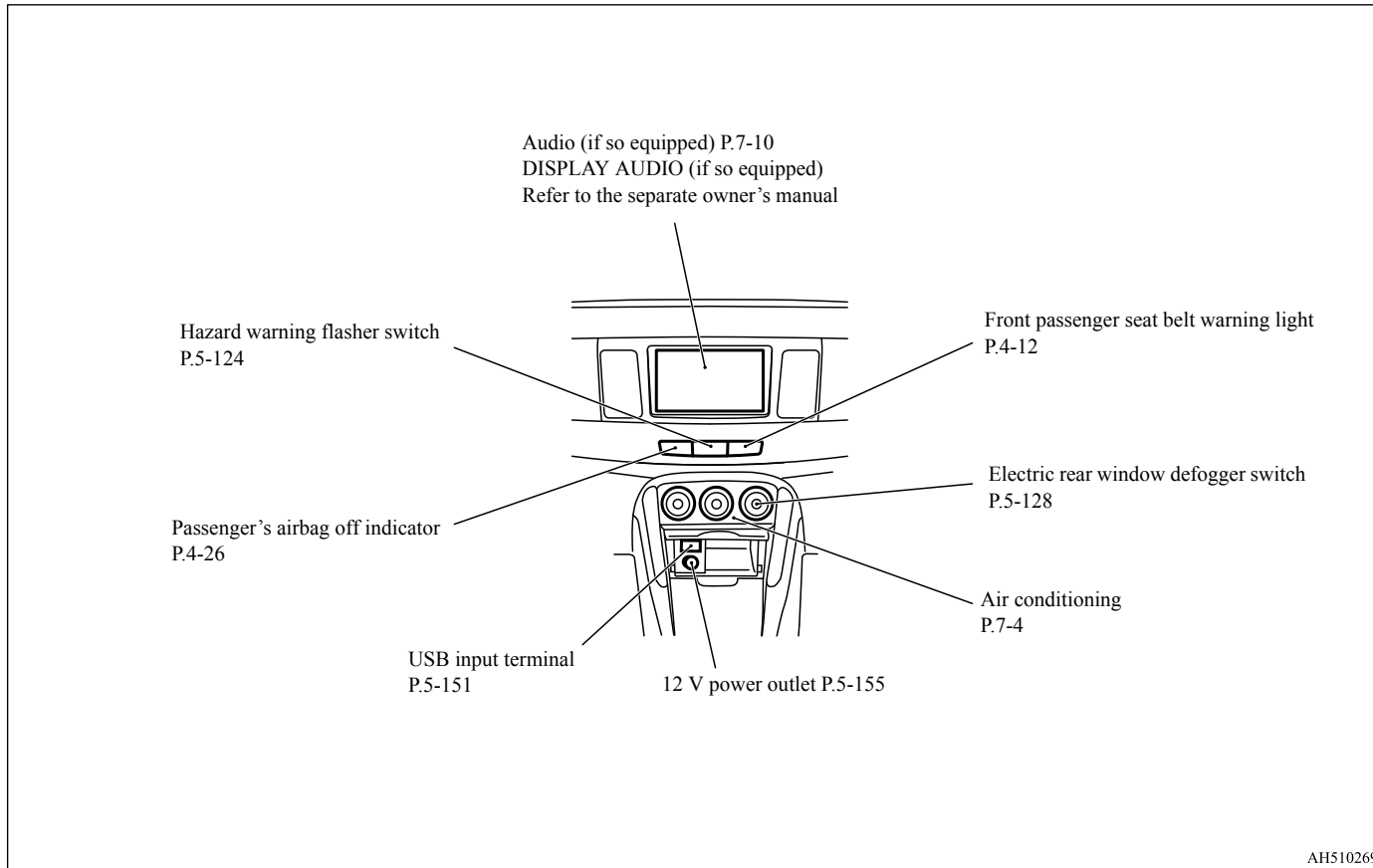

1-3 Overview

Interior

1

N00100302398

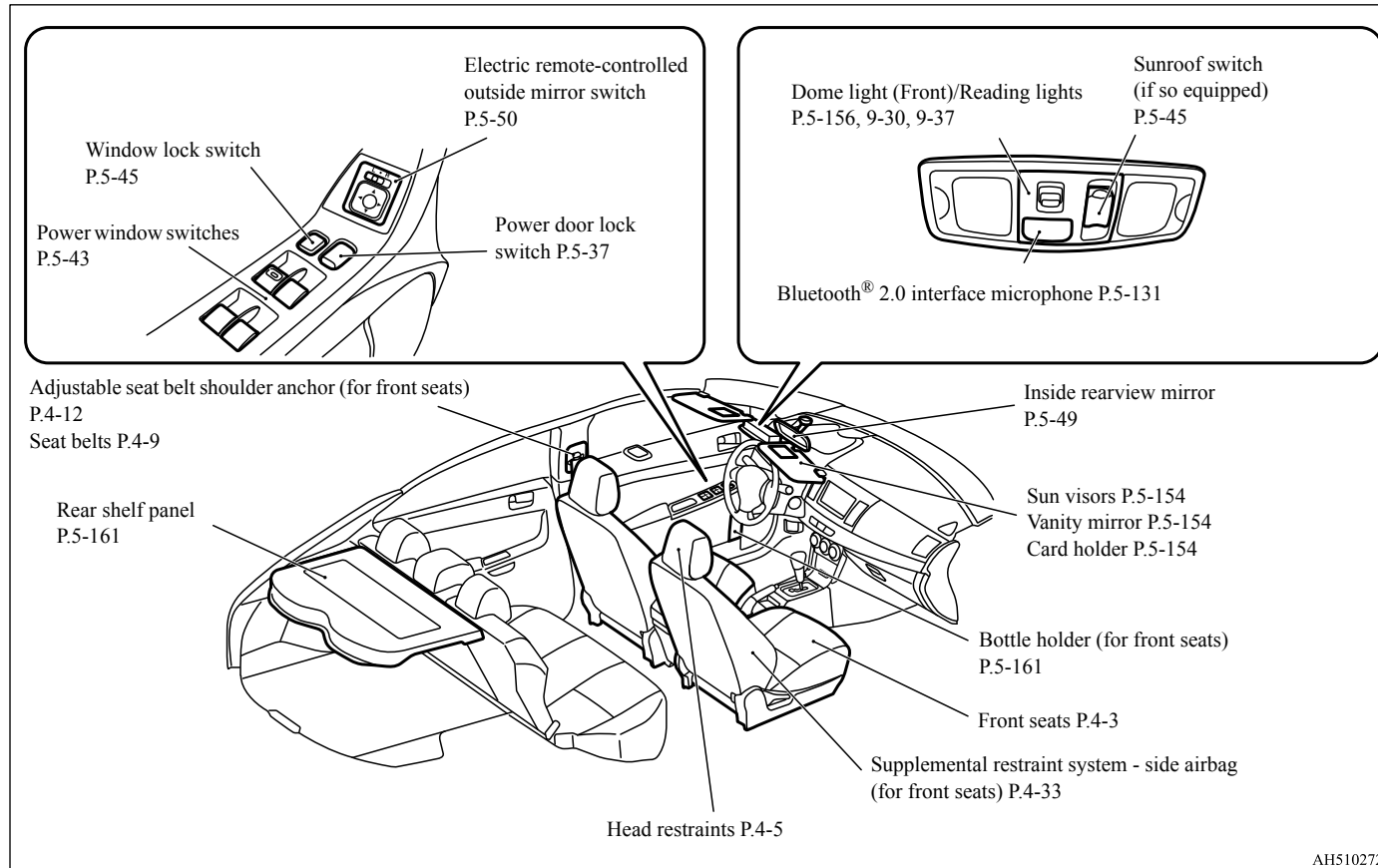

AH5102722

Interior

1

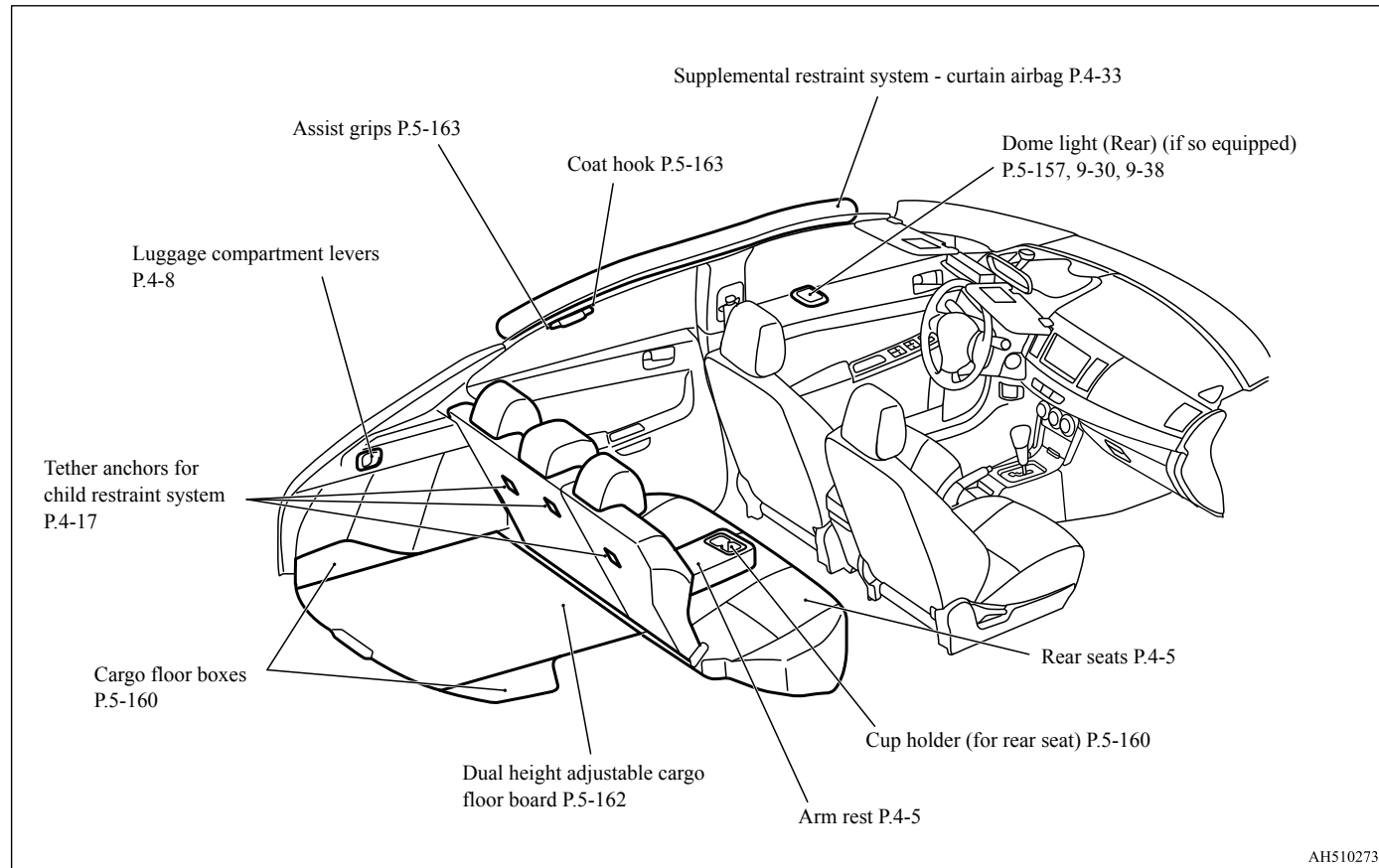

1-5 Overview

Luggage compartment

1

N00100501481

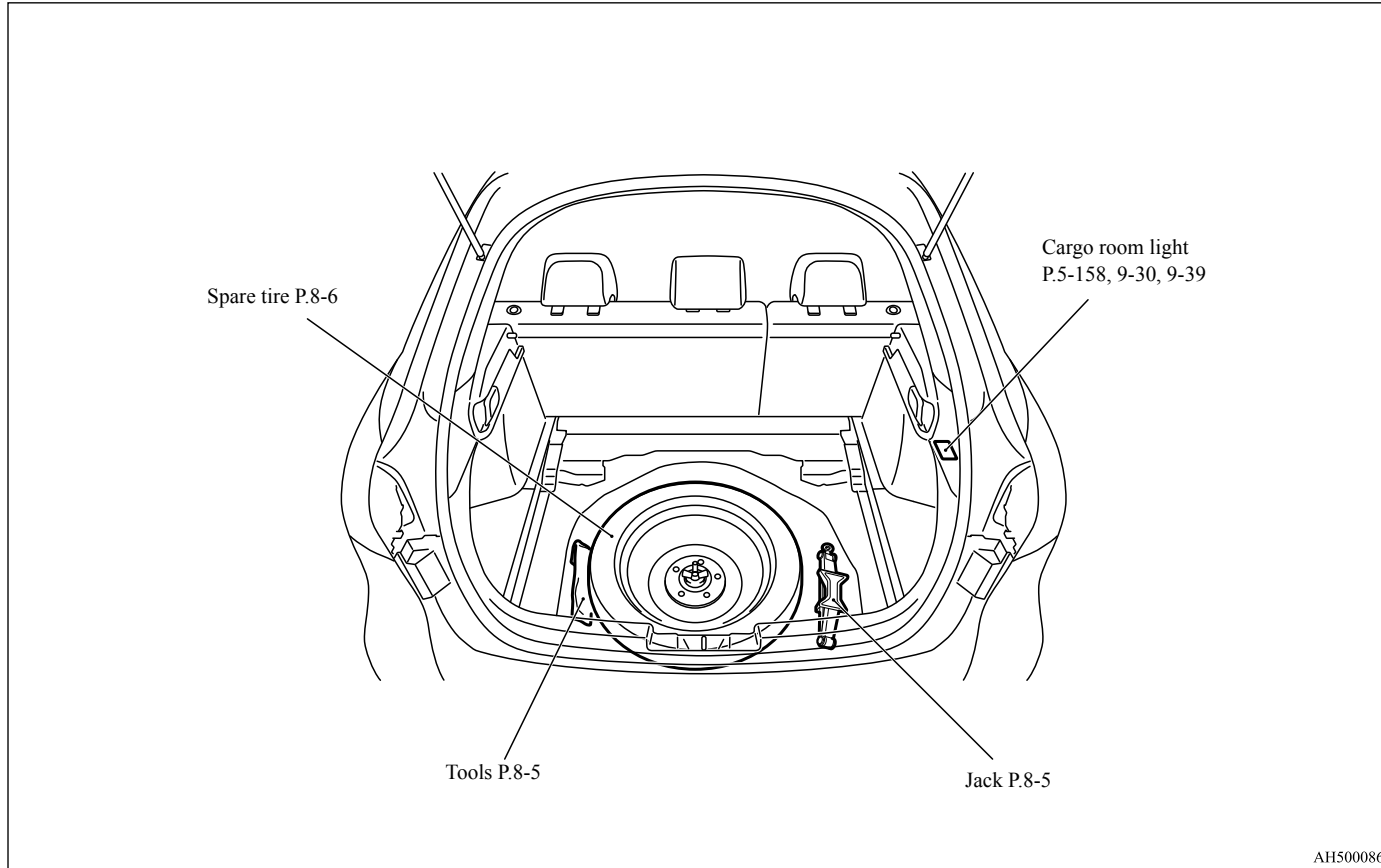

AH5000860

Overview 1-6

Outside (Front)

1 Outside (Front)

N00100602607

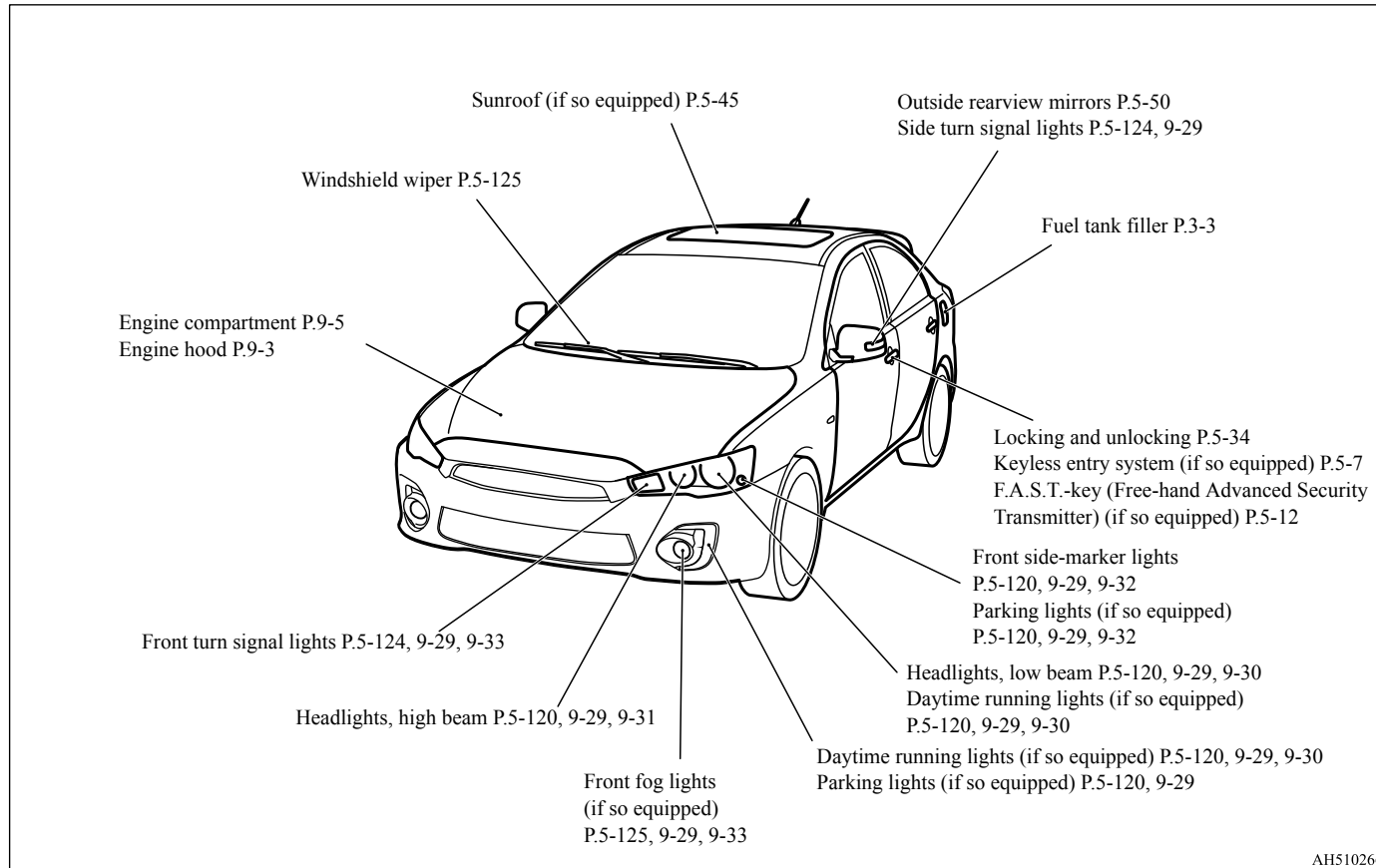

AH5102663

Outside (Rear)

1

N00100602522

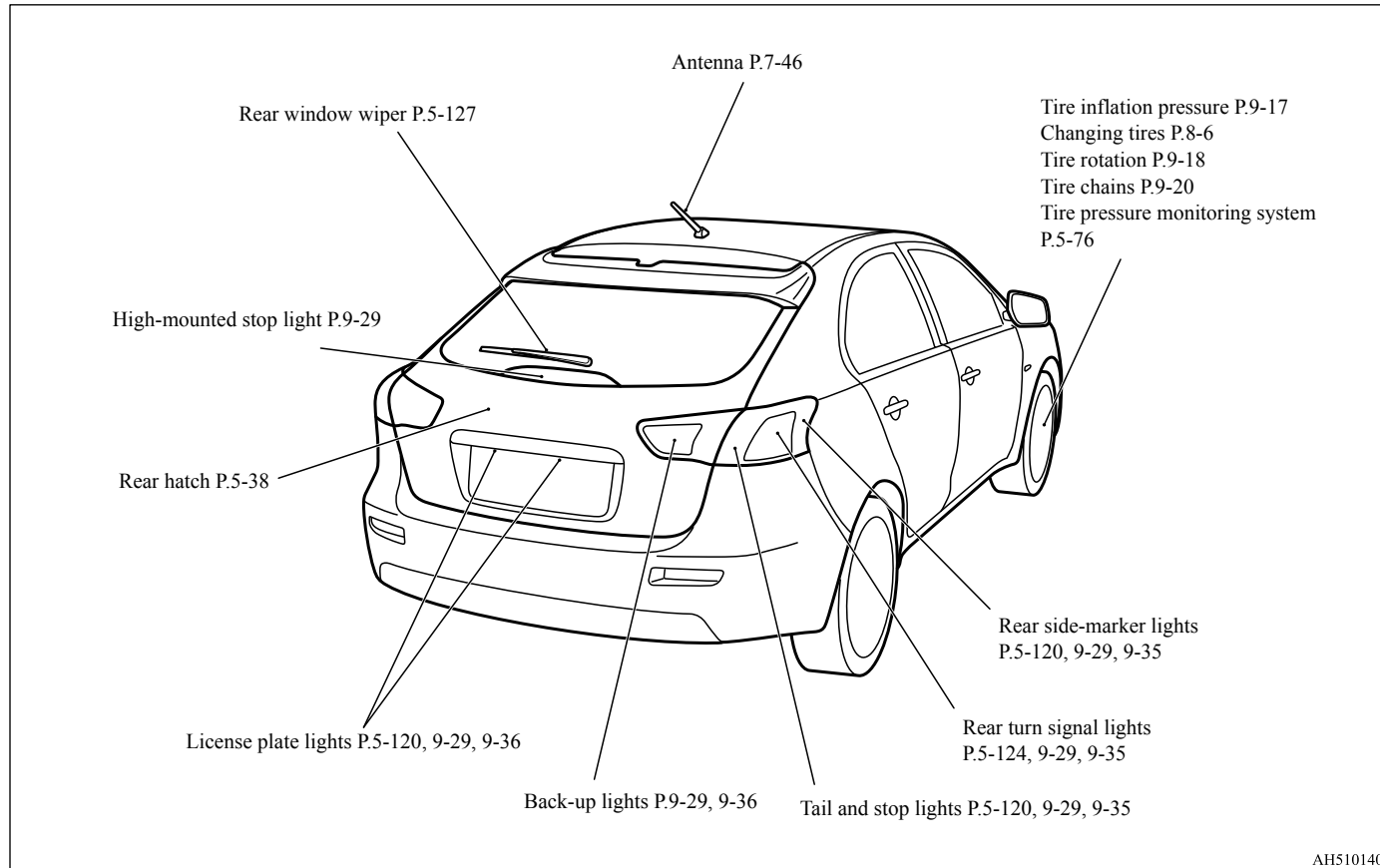

AH5101406

If this warning light comes on or flashes while you're driving...



If this warning light comes on or flashes while you're driving...

N00200702218

2



NOTE

- For information regarding warning displays in the multi-information display, refer to “Multi-information display” on page 5-84.
- These warning lights will come on for a few seconds for a bulb check when the ignition switch is first turned to “ON”.

Warning light	Do this	Ref. page
 Charging system warning light	<ul style="list-style-type: none"> ● Park your vehicle in a safe place and stop the engine. Contact an authorized Mitsubishi Motors dealer or a repair facility of your choice for assistance. 	P.5-118
 Brake warning light	<ul style="list-style-type: none"> ● If this light comes on while driving, check to see that the parking brake is fully released. ● If this light stays on after releasing the parking brake, stop and check the brake fluid level. ● If the brake fluid level is correct, there may be a system malfunction. Avoid hard braking and high speeds, and contact an authorized Mitsubishi Motors dealer or a repair facility of your choice for assistance. 	P.5-117
 Engine malfunction indicator (“Check engine light”)	<ul style="list-style-type: none"> ● Although your vehicle will usually be drivable and not need towing, have the engine system checked at an authorized Mitsubishi Motors dealer or a repair facility of your choice as soon as possible. If the vehicle is not drivable, contact emergency roadside assistance at 1-888-648-7820 (for vehicles sold in U.S.A.) or 1-888-576-4878 (for vehicles sold in Canada), an authorized Mitsubishi Motors dealer, or local towing company for assistance. 	P.5-117

If this warning light comes on or flashes while you're driving...

2

Warning light	Do this	Ref. page
 Anti-lock braking system warning light	<ul style="list-style-type: none"> ● When this light comes on, the anti-lock braking system is not functioning and only the ordinary braking system is functioning. ● Park your vehicle in a safe place and stop the engine. Test the system as described on page 5-67. ● If the light does not go out after the test, or if it comes on again, we recommend that you have the system checked at an authorized Mitsubishi Motors dealer or a repair facility of your choice as soon as possible. 	P.5-67, 5-67
 SRS warning light	<ul style="list-style-type: none"> ● Immediately have the airbag and the pre-tensioner seat belt system checked at an authorized Mitsubishi Motors dealer. 	P.4-14, 4-27
 Tire pressure monitoring system warning light	<ul style="list-style-type: none"> ● If the warning light comes on, you should stop and adjust the tires to the proper inflation pressure as soon as possible. (See "Tire inflation pressures" on page 9-17.) Once adjustments have been made, the warning light will go off after a few minutes of driving. ● If the warning light blinks for approximately 1 minute and then remains continuously illuminated, the system is not operating properly. If the system returns to normal, the warning light will go off. If the warning light does not go off, have the vehicle inspected at an authorized Mitsubishi Motors dealer. 	P.5-77

If this problem occurs...

If this problem occurs...

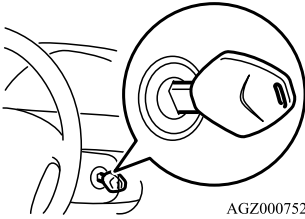
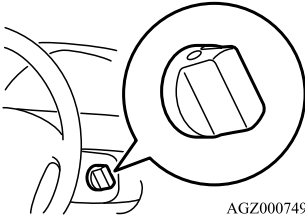

N00200901952

2



Problem	Do this	Ref. Page
<p>Cannot turn the key. (When using a key to start the engine)</p>  <p style="text-align: right; font-size: small;">AGZ000752</p>	<p>When using a key to start the engine Will not turn from “LOCK” to “ACC”. Turn the key while turning the steering wheel in either direction.</p> <p>Will not turn from “ACC” to “LOCK”. Vehicles equipped with continuously variable transmission (CVT): Check the position of the selector lever. The key cannot be removed unless the selector lever is set to the “P” (PARK) position. Vehicles equipped with manual transaxle: Place the key at the “ACC” position. Push the key in and turn it.</p>	<p>P.5-53</p>
<p>(When using the F.A.S.T.-key to start the engine)</p>  <p style="text-align: right; font-size: small;">AGZ000749</p>	<p>When using the F.A.S.T.-key to start the engine Will not turn from “LOCK (PUSH OFF)” to “ACC”. Push the ignition switch again, turn the steering wheel in both directions and then turn the ignition switch.</p> <p>Will not turn from “ACC” to “LOCK”. Vehicles equipped with CVT: Check whether the selector lever is set to the “P” (PARK) position. Vehicles equipped with manual transaxle: Place the ignition switch at the “ACC” position. Push the ignition switch in and turn it.</p>	<p>P.5-12</p>
<p>The F.A.S.T.-key does not operate. (for vehicles equipped with the F.A.S.T.-key)</p>	<p>Use the emergency key to lock and unlock the doors and start the engine.</p>	<p>P.5-22</p>

If this problem occurs...

2

Problem	Do this	Ref. Page
Cannot shift the selector lever from the “P” (PARK) position. (for vehicles equipped with CVT)	Shift the selector lever while pressing the brake pedal. Check that the ignition key or ignition switch is in the “ON” position.	P.5-59
The windows are fogged up. 	1. Set the mode selection dial to the “  ” or “  ” position. 2. Turn on the blower.	P.7-8
The engine does not start. The lights do not come on. The lights are dim. The horn does not honk. The horn sound is weak.	Have the battery checked. Recharge or replace as needed.	P.8-2, 9-11

If this problem occurs...

Problem	Do this	Ref. page
<p>The engine coolant temperature display “ <p>Type 2</p>  </p>	<p>The engine is overheated. Carefully stop the vehicle in a safe place.</p>	<p>P.8-4</p>
<p>The vehicle is stuck in sand, mud, or snow.</p>	<p>Rock your vehicle back and forth to free it.</p>	<p>P.8-12</p>

2



⚠ WARNING

- When attempting to rock your vehicle out of a stuck position, be sure that no one is near the vehicle. The rocking motion may cause the vehicle to suddenly lurch forward or backward, possibly injuring bystanders.
- Avoid revving the engine or spinning the wheels. Prolonged efforts to free a stuck vehicle may result in overheating and transaxle failure. If the vehicle remains stuck after several rocking attempts, have a towing service pull the vehicle out.

Quick index 2-5

If this problem occurs...

2

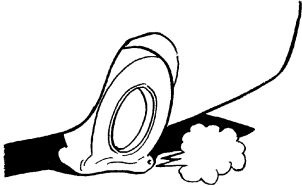
Problem	Do this	Ref. page
The brakes are not functioning properly after driving through water.	Dry out the brakes by driving slowly while lightly pressing the brake pedal.	P.6-5
The CVT makes no engine speed to vehicle speed ratio change when accelerating. The initial movement of the vehicle is slow when the vehicle starts moving. (for vehicles equipped with CVT)	There may be a problem in the CVT. If the  or  warning lights on the multi-information display will not turn off, or if they are coming on frequently, please have the vehicle checked at your nearest Mitsubishi Motors dealer.	P.5-64
A tire is punctured. 	<ol style="list-style-type: none"> 1. Park the vehicle in a safe place where the surface is flat and level. 2. Replace the flat tire with the spare tire. 	P.8-6

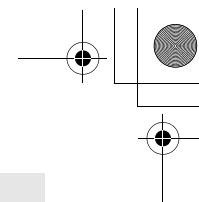

General information

Fuel selection	3-2
Filling the fuel tank	3-3
Modifications to and racing of your vehicle	3-5
Mitsubishi Motors genuine parts	3-6
California Perchlorate Materials Requirements	3-6

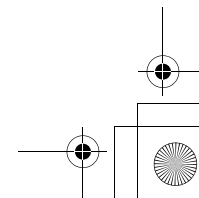
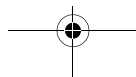
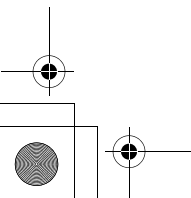
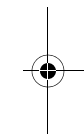
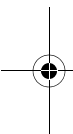

Fuel selection

Fuel selection

N00301001935

3

Your vehicle is designed to use unleaded gasoline only. It is equipped with a fuel filler tube especially designed to accept only a small diameter unleaded gasoline dispensing nozzle.

WARNING

- Gasoline is highly flammable and explosive. You could be burned, seriously injured or killed when handling it. Whenever you refuel your vehicle, stop the engine and keep flames, sparks, and smoking materials away from the vehicle. Always handle fuel in well-ventilated outdoor areas.

CAUTION

- Using leaded gasoline in your vehicle will damage the engine, catalytic converter, and the oxygen sensors. Also, using leaded gasoline is illegal, and will void your warranty coverage of the engine, catalytic converter, and oxygen sensors.

Gasoline detergent additives

In the United States, fuel suppliers are required by law to add detergents to their gas-

3-2 General information

oline to minimize fuel-injector fouling and minimize intake-valve deposits. Detergent gasoline helps keep your engine in tune and your emission-control system working properly.

Octane requirement

Your vehicle is designed to operate on unleaded gasoline having a minimum octane number of 87 [(MON+RON)/2], or 91 RON.

MON: Motor Octane Number

RON: Research Octane Number

Oxygenated gasoline

Gasoline sold at some service stations contains oxygenates such as ethanol, although the oxygenates may not be identified by those names. Oxygenates are required in some areas of the country. Such fuel can be used in your vehicle.

Ethanol (Gasohol)

A mixture of up to 10 % ethanol (grain alcohol) and 90 % unleaded gasoline may be used in your vehicle, provided the octane number

is at least as high as that recommended for unleaded gasoline.

Methanol

Do not operate your vehicle on gasoline containing methanol (wood alcohol). Using this type of alcohol could adversely affect the vehicle's performance and damage critical parts of the vehicle's fuel system.

Reformulated gasoline

Many areas of the country require the use of cleaner burning fuel referred to as "Reformulated Gasoline".

Reformulated gasoline contains oxygenates and is specially blended to reduce vehicle emissions and improve air quality.

Mitsubishi Motors Corporation strongly supports the use of reformulated gasoline. Properly blended reformulated gasoline has no adverse effect on vehicle performance or the durability of the engine and fuel system.

MMT (methylcyclopentadienyl manganese tricarbonyl)

MMT is a manganese-containing metallic additive that is blended into some gasolines to increase the octane number. Mitsubishi Motors Corporation recommends using gasolines without MMT. Use of gasolines blended with MMT may adversely affect performance, and cause the malfunction indicator on your instrument panel to come on. If this happens, contact an authorized Mitsubishi Motors dealer or a repair facility of your choice for assistance.

Sulfur in gasoline

Your vehicle may have been designed to satisfy California's low-emission regulations based on clean-burning low-sulfur gasoline. Gasoline sold in parts of the country other than California is allowed to have a higher sulfur content. Using such gasoline could adversely affect the vehicle's catalytic converter and cause the engine malfunction indicator ("Check engine light") to come on. Illumination of this indicator while you are using high-sulfur gasoline does not necessarily mean the vehicle's emission-control system is malfunctioning. Your authorized Mitsubishi Motors dealer may suggest you

try using a different, lower-sulfur brand of unleaded gasoline to determine whether the problem is fuel-related.

NOTE

- Poor-quality gasoline can cause problems such as poor starting, stalling during idling, abnormal engine noise, and poor acceleration. If you experience any of these problems, try using a different brand of gasoline. If the engine malfunction indicator ("Check engine light") flashes, have the vehicle inspected as soon as possible by the nearest authorized Mitsubishi Motors dealer or a repair facility of your choice.
- Repeatedly driving short distances at low speeds can cause deposits to form in the fuel system and engine, resulting in poor starting and poor acceleration. If these problems occur, you are advised to add a detergent additive to the gasoline when you refuel the vehicle. The additive will remove the deposits, thereby returning the engine to a normal condition. Be sure to use a Mitsubishi Motors Genuine cleaning additive. Using an unsuitable additive could make the engine malfunction. For details, please contact the nearest authorized Mitsubishi Motors dealer.

Filling the fuel tank

Filling the fuel tank

N00301101952

⚠ WARNING

- **Gasoline is highly flammable and explosive. You could be burned, seriously injured or killed when handling it. When refueling your vehicle, always turn the engine off and keep away from flames, sparks, and smoking materials. Always handle fuel in well-ventilated outdoor areas.**
- **Before removing the fuel cap, be sure to get rid of your body's static electricity by touching a metal part of the car or fuel pump. Any static electricity on your body could create a spark that ignites fuel vapor.**
- **Perform the whole refueling process (opening the fuel tank filler door, removing the fuel cap, etc.) by yourself. Do not let any other person come near the fuel tank filler. If you allowed a person to help you and that person was carrying static electricity, fuel vapor could be ignited.**
- **Do not move away from the fuel tank filler until refueling is finished. If you moved away and did something else (for example, sitting on a seat) part-way through the refueling process, you could pick up a fresh charge of static electricity.**
- **Be careful not to inhale fuel vapor. Fuel contains toxic substances.**

3

Filling the fuel tank

⚠ WARNING

- Keep the doors and windows closed while refueling the vehicle. If they were open, fuel vapor could get into the cabin.

3

Fuel tank capacity

15.5 gal (59 liters)

Refueling

1. Before filling with fuel, stop the engine.
2. The fuel tank filler is located on the rear driver side of your vehicle.

The fuel tank filler door can be opened from inside the vehicle with the fuel tank filler door release lever located at the left side of the driver's seat.

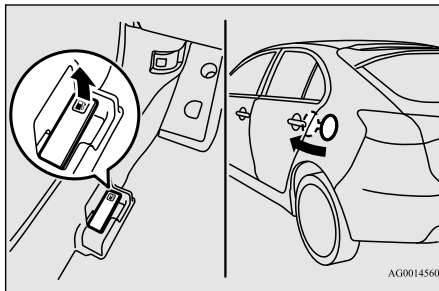

3. Open the fuel tank filler pipe by slowly turning the cap counterclockwise.

3-4 General information

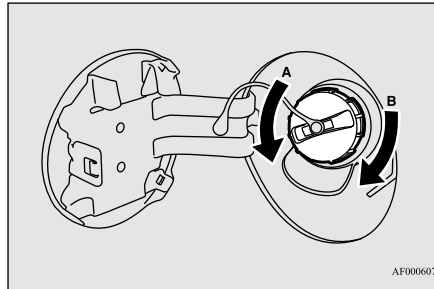

- A- Remove
- B- Close

⚠ WARNING

- Since the fuel system may be under pressure, remove the fuel tank filler cap slowly. This relieves any pressure or vacuum that might have built up in the fuel tank. If the cap is venting vapor or if you hear a hissing sound, wait until it stops before removing the cap. Otherwise, fuel may spray out, injuring you or others.

4. While filling with fuel, store the cap in the cap holder located on the inside of the fuel tank filler door.

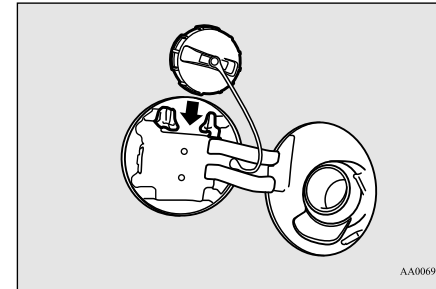

5. To fill with fuel correctly depends mainly on correct handling of the fuel filler nozzle. Do not tilt the nozzle. Insert the nozzle in the tank port as far as it will go.

⚠ CAUTION

- Your vehicle can only be operated using unleaded gasoline. Serious engine and catalytic converter damage will result if leaded gasoline is used.

6. When the nozzle stops automatically, do not attempt to add more fuel.

⚠ CAUTION

- To avoid fuel spillage and overfilling, do not "top-off" the fuel tank. Spilled fuel could discolor, stain, or crack the vehicle's paintwork. If fuel spills on the paintwork, wipe it off with a soft cloth.

7. To close, turn the fuel tank filler cap slowly clockwise until you hear clicking sounds, then gently push the fuel tank filler door closed.

WARNING

- **Make sure the fuel cap is securely closed. If the fuel cap is loose, fuel could leak, resulting in a fire.**

CAUTION

- If you need to replace the fuel tank filler cap, use only the cap specified for your model vehicle.

NOTE

- If the fuel tank filler cap is not tight while driving, the engine malfunction indicator (“Check engine light”) may come on when the onboard diagnostic (OBD) system performs a self check.
Always tighten the fuel tank filler cap until you hear clicking sounds.
The indicator will go off after driving several times. If the indicator does not go off, contact your authorized Mitsubishi Motors dealer or a repair facility of your choice as soon as possible.

Modifications to and racing of your vehicle

N00301600178

This vehicle should not be modified with non-Mitsubishi Motors genuine parts. Mitsubishi Motors designs and manufactures high quality vehicles with an emphasis on safety and durability. Modifications using non-Mitsubishi Motors genuine parts may affect the performance, safety and/or durability of your vehicle, and may violate applicable state and/or federal regulations.

DAMAGE OR PERFORMANCE PROBLEMS RESULTING FROM MODIFICATIONS TO OR RACING OF YOUR VEHICLE ARE NOT COVERED UNDER WARRANTY.

Examples of modifications to your vehicle that can cause damage or performance problems include the following:

- Failure to use Mitsubishi Motors genuine parts
- Failure to use required fuel and fluids
- Failure to use proper size tires and wheels
- Modification of the fuel, intake, exhaust, emission, suspension, engine, drive train or electrical wiring systems

Modifications to and racing of your vehicle

- Modification of any onboard computer/control module, including reprogramming, or replacing/adding chips to any onboard computer/control module

Review the Warranty and Maintenance Manual for further details regarding warranty coverage.

Installation of accessories

N00301700023

CAUTION

- Before any electrical or electronic accessories are installed, consult an authorized Mitsubishi Motors dealer.

- The installation of accessories, optional parts, etc., should only be carried out within the limits prescribed by law in the driving area and in accordance with the guidelines and warnings contained within the documents accompanying this vehicle. Only Mitsubishi Motors approved accessories should be fitted to your vehicle.
- Improper installation of electrical parts could cause fire. Refer to the “Modification/alterations to the electrical or fuel systems” section within this owner’s manual.

3



3

Mitsubishi Motors genuine parts

- Using a cellular phone or radio set inside the vehicle without an external antenna may cause electrical system interference, which could lead to unsafe vehicle operation.
 - Tires and wheels which do not meet specifications must not be used.
- Refer to the “Specifications” section for information regarding wheel and tire sizes.

WARNING

- **If you choose to use a cellular phone while driving, you must not allow that usage to distract you in the safe operation of your vehicle. Anything, including cellular phone usage, that distracts you from the safe operation of your vehicle increases your risk of an accident. Refer to and follow all state and local laws in your area regarding cellular phone usage while driving.**

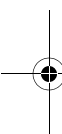

Important point!

Due to the large number of accessory and replacement parts provided by different manufacturers in the market, it is not always possible for an authorized Mitsubishi Motors dealer to check whether the attachment or installation of non-Mitsubishi Motors genu-

3-6 General information



ine parts will affect the driving safety of your Mitsubishi-vehicle.

Modification/alterations to the electrical or fuel systems

N00301800167

Mitsubishi Motors manufactures high quality vehicles with an emphasis on safety. It is important to consult an authorized Mitsubishi Motors dealer before installation of any accessory which may involve modification of the electrical or fuel systems.

CAUTION

- Please consult an authorized Mitsubishi Motors dealer concerning any such accessory fitment or modification.
- If the wires interfere with the vehicle body or improper installation methods are used (protective fuses not included, etc.), electronic devices may be adversely affected, resulting in a fire, vehicle damage, or other accident.

Mitsubishi Motors genuine parts

N00301400235

Mitsubishi Motors Genuine Parts are designed and manufactured to meet high standards of performance, and are recommended for all of your maintenance needs. Also avail-

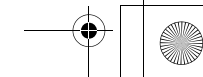
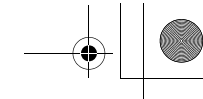
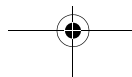

able from your Mitsubishi Motors dealer are a wide variety of accessories to personalize your new vehicle. Each Mitsubishi Motors vehicle has a selection of Mitsubishi Motors authorized accessories to choose from to tailor your new vehicle to your own personal preference. Your Mitsubishi Motors dealer's Parts Manager has information on various audio systems, protection items, as well as interior and exterior accessories available for your specific model.

California Perchlorate Materials Requirements

N00300100017

Certain components of this vehicle, such as airbag modules, seat belt pretensioners, and button cell batteries, may contain perchlorate materials.

Special handling may apply. For additional information, see www.dtsc.ca.gov/hazardous-waste/perchlorate.

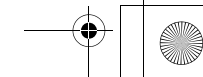

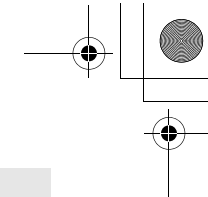

Seat and restraint systems

Seats	4-2
Seats and restraint systems	4-2
Front seats	4-3
Rear seats	4-5
Head restraints	4-5
Extending a luggage compartment	4-7
Seat belts	4-9
Seat belt use during pregnancy	4-13
Seat belt pre-tensioner and force limiter systems	4-13
Child restraint systems	4-14
Maintenance and inspection of seat belts	4-21
Supplemental Restraint System (SRS) - airbag	4-21

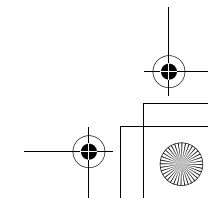
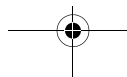
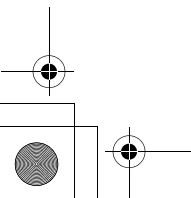
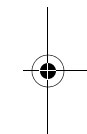
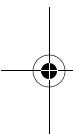

Seats

Seats

N00408401551

4

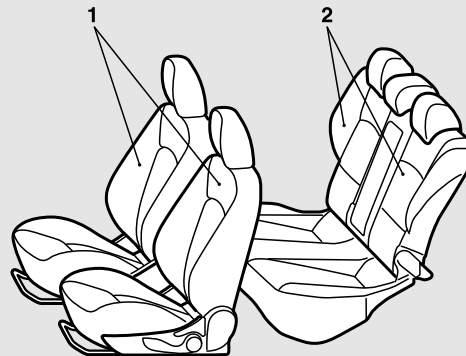

AG1000957

1 - Front seats

- To adjust the seat forward or backward → P.4-3
- To adjust the seatback → P.4-3
- To adjust the seat height (driver's side only) → P.4-4
- Heated seats → P.4-4

2 - Rear seats

- Arm rest → P.4-5

Seats and restraint systems

N00401600182

Your vehicle has seat belts and other features that help protect you and your passengers in an accident.

Seat belts are the most important safety device. When worn properly, seat belts can reduce the chance of serious injury or death in various types of crashes. For added protection during a severe frontal collision, your vehicle has a Supplemental Restraint System (SRS) with airbags for the driver and passengers. The seats, head restraints, and door

locks also are safety equipment, which must be used correctly.

Always check the following before you drive:

- That everyone in your vehicle is properly wearing their seat belt.
- That infants and small children are properly secured in appropriate child restraint systems in the rear seat.
- That all doors are fully closed and locked.
- That seatbacks are upright, with head restraints properly adjusted.

Safety equipment cannot prevent injury or death in all motor vehicle accidents. You can help reduce the risk of injury or death, however, by following the instructions in this manual.

Front seats

N00401801439

Position the driver's seat as far back as possible while maintaining a position that still enables you to fully apply the pedals, easily control the steering wheel and safely operate the vehicle.

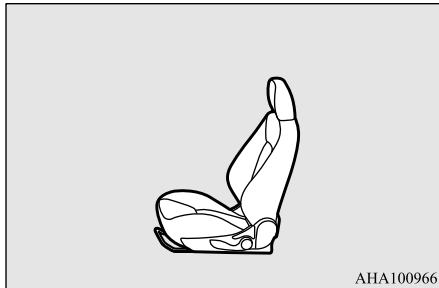

AHA100966

⚠ WARNING

- Do not attempt to adjust the seat while driving. This can cause loss of vehicle control and result in an accident.
- After adjusting the seat, make sure that the seat is securely locked into position.

⚠ WARNING

- To reduce the risk to the driver of serious injury or death during deployment of the driver's airbag, always properly wear the seat belt and adjust the driver's seat as far back as possible while maintaining a position that still enables you to fully apply the pedals, easily control the steering wheel, and safely operate the vehicle.
- To reduce the risk to the front passenger of serious injury or death during deployment of the passenger's airbag, always properly wear the seat belt and adjust the front passenger's seat as far back as possible.
- Always place children 12 years old and under in the rear seat and use appropriate child restraint systems.

⚠ CAUTION

- Make sure that the seat is adjusted by an adult. If it is adjusted by a child, an unexpected accident might occur.
- Do not place a cushion or the like between your back and the seatback while driving. The effectiveness of the head restraints will be reduced in the event of an accident.
- When sliding the seats, be careful not to catch your hand or leg.
- When sliding or reclining the seat rearward, pay careful attention to the rear seat passengers.

Front seats

To adjust the seat forward or backward

N00401901342

Pull the seat adjusting lever up and slide the seat forward or backward to the desired position. Release the adjusting lever to lock the seat in place.

4

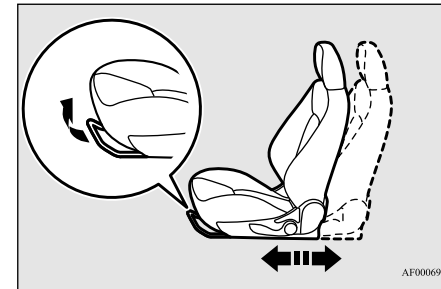

AF0006962

⚠ WARNING

- To make sure that the seat is securely locked, try to move it forward or backward without using the adjusting lever.

To adjust the seatback

N00402001395

To adjust the seatback, lean forward slightly, gently pull the seatback lock lever up, then lean backward to a comfortable position and

Front seats

release the lever. The seatback will lock in place.

4

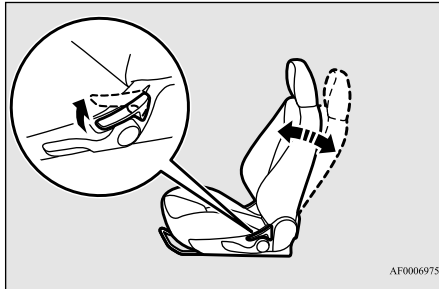

CAUTION

- The reclining mechanism used in the seatback is spring loaded, and will cause the seatback to return quickly to the vertical position when the lock lever is operated. When pulling the lever, sit close to the seatback or hold the seatback with your hand to control its return motion.

WARNING

- To reduce the risk of serious injury or death in the event of an accident or sudden stop, all seatbacks should be kept in the upright position while the vehicle is in motion. Seat belt performance during an accident can be adversely affected if the seatbacks are reclined. The more a seatback is reclined, the more likely seat belt performance will be adversely affected. If the seat belt is not properly positioned against the body during an accident, there is increased risk you will slide under the belt and receive serious injury or death.

To adjust the seat height (driver's side only)

N00402101266

Operate the lever repeatedly to raise or lower the seat.

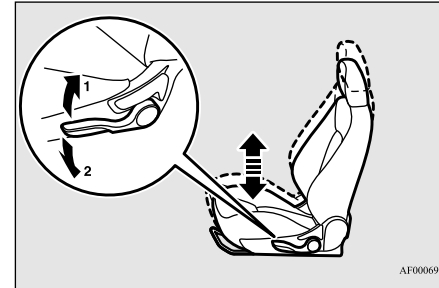

- 1- Raise
- 2- Lower

Heated seats

N00435601421

The heated seats can be operated when the ignition switch is in the "ON" position.

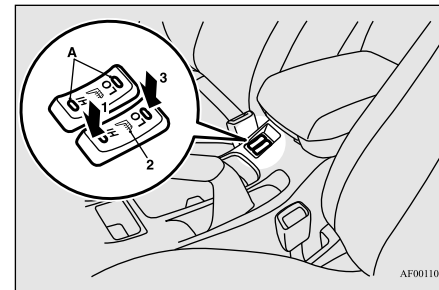

- 1 (HI) - Heater high (for quick heating)
- 2 - Heater off

3 (LO) - Heater low (to keep the seat warm)

The indicator light (A) will illuminate while the heater is on.

WARNING

● **Persons who are unable to feel temperature change or skin pain due to age, illness, injury, medication, alcohol use, fatigue or other physical conditions or who have sensitive skin may suffer burns when using the heated seat even at low temperatures. To reduce the risk of burns, people with such conditions must use care when using the heated seat.**

CAUTION

- Switch off the seat heaters when not in use. Operate the heaters at the “HI” position for quick heating. After the seat has become warm, set the heater switch to the “LO” position to keep it warm. Slight variations in the seat temperature may be felt while using the heated seats. This is caused by the operation of the heater’s internal thermostat and does not indicate a malfunction.
- Do not place heavy objects on the seat or stick pins, needles, or other pointed objects into the seat.
- Do not place a blanket, cushion, or other insulating material on the seat while using the heater; doing so can cause the heater element to overheat.

CAUTION

- When cleaning the seat, do not use benzine, kerosene, gasoline, alcohol, or other organic solvents; doing so can cause damage not only to the surface of the seat, but also to the heater.
- If water or any other liquid is spilled on the seat, allow it to dry thoroughly before attempting to use the heater. Turn the heater off immediately if it appears to be malfunctioning during use.

Rear seats

N00402500162

Arm rest

N00403000265

Tilt the arm rest down for use as shown. The arm rest includes a cup holder. (Refer to “Cup holder” on page 5-160.)

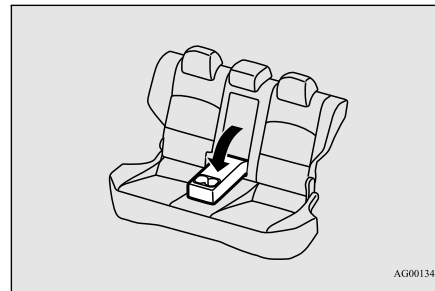

Rear seats

Head restraints

N00404301608

Padded head restraints for the seats can reduce the risk of a whiplash injury if your vehicle is hit from the rear.

The head restraints are equipped in the illustrated position.

To maximize the effectiveness of your head restraint, adjust the head restraint to the proper position. For the driver and front passenger, adjust the seatbacks to the upright position before adjusting the head restraints. Sit back against the seatback with your head close to the head restraint.

4

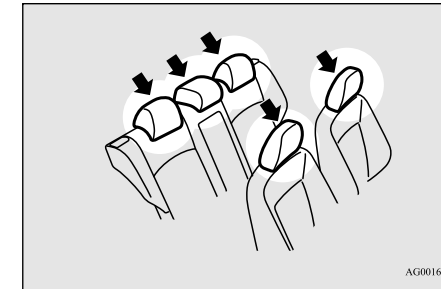

Head restraints

4

WARNING

- In order to minimize the risk of a neck injury due to a rear impact, the head restraint must be adjusted to the proper position before vehicle operation. For the driver and front passenger, the seatbacks must be adjusted to the upright position before adjusting the head restraints. The driver should never adjust the seat while the vehicle is in motion.
- Driving without the head restraints in place can cause you and your passengers serious injury or death in an accident. To reduce the risk of injury in an accident, always make sure the head restraints are installed and properly positioned when the seat is occupied.
- Never place a cushion or similar device on the seatback. This can adversely affect head restraint performance by increasing the distance between your head and the restraint.

Adjustment of the head restraint height

To reduce the risk of injury in an accident, adjust the head restraint height so that the center of the restraint is at your eye level when seated. Any person too tall for the restraint to reach their eye level when seated

should raise the restraint to the highest locked position.

- To raise the restraint, pull it straight up.
- To lower the restraint, push down on it while pressing the lock knob (A) in the direction shown by the arrow.
- After adjusting the height, push down on the restraint to make sure it is locked in position.

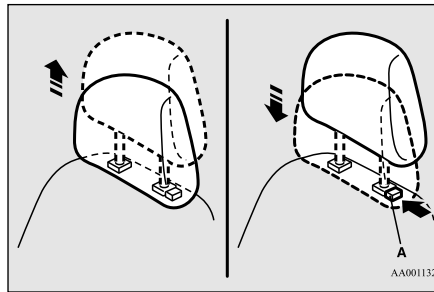

To remove

Press the lock knob (A) in the direction shown by the arrows. Then pull the head restraint up and out of the seatback.

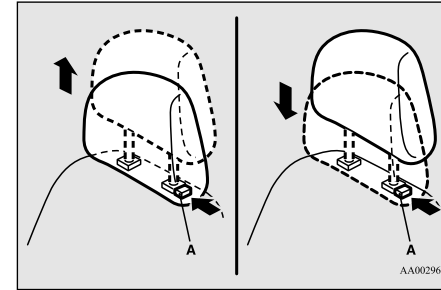

WARNING

- To help minimize the risk of neck injury in the event of an accident, the head restraints must be properly installed and positioned to proper height before vehicle operation.

To install

First check that the head restraint is facing in the right direction as shown in the previous illustration, and then insert it into the seatback. Push the head restraint down while pressing the lock knob (A) until the restraint locks into place.

CAUTION

- Check that the lock knob (A) is extended out as shown in the illustration. Then pull the head restraint up to make sure that it is locked in place and will not come out of the seatback.

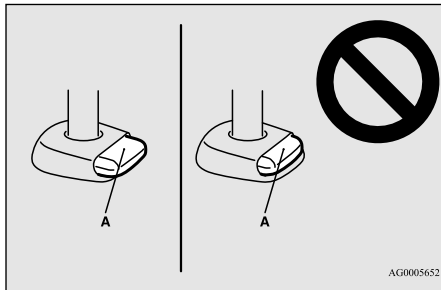

CAUTION

- The shape and size of the head restraint differs according to the seat. Always use the correct head restraint provided for the seat and do not install the head restraint in the wrong direction.

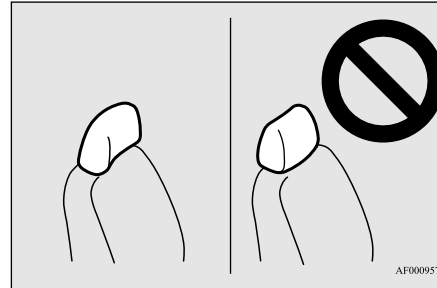

Extending a luggage compartment

N0040550088

WARNING

- Never adjust the seats to extend a luggage compartment while the vehicle is in motion or on a slope. The seats could move suddenly and cause serious injury or an accident.
- After returning a seatback to its normal position, make sure that the seatback is firmly secured. If the seatback is not secured, it could move and cause a serious accident.
- Do not allow anyone to ride in the luggage compartment while the vehicle is in motion. People who are not properly seated and restrained can be seriously injured or killed in an accident.

Extending a luggage compartment

WARNING

- The luggage compartment in the rear of the vehicle should never be used as a play area by children. All children should be properly restrained in a restraint device that offers the maximum protection for their size and age. Refer to “Child restraint systems” on page 4-14.
- The front passenger seat is equipped with weight sensors. Depending on the weight detected, the front passenger airbag is disabled or enabled. When folding the rear seats forward for increased cargo capacity, the front passenger seat and seatback must be adjusted to assure they are not contacting the rear seat. In the event the front seat or seatback is allowed to contact the folded rear seat, proper operation of the front passenger airbag system may be affected.

4

CAUTION

- In the luggage compartment, do not load the luggage higher than the top of the seats and make sure that the luggage is firmly secured. Restricted rear vision or unsecured objects entering the passenger compartment from the luggage compartment during sudden braking can cause serious injury or an accident.
- Seatbacks should always be folded and put back into normal position by an adult. Seat adjustments by a child could lead to an unexpected accident.

Extending a luggage compartment

⚠ CAUTION

- When adjusting the seats, be careful not to catch your hand or leg. Personal injury could result.

4

📖 NOTE

- When the seatback of a front seat is reclined, return it to the upright position before driving.

Rear seat release buttons

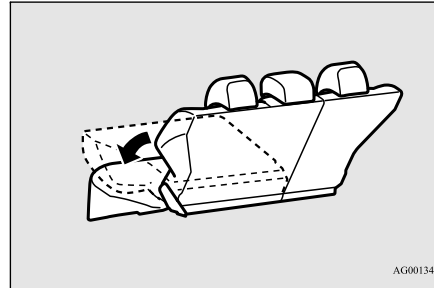
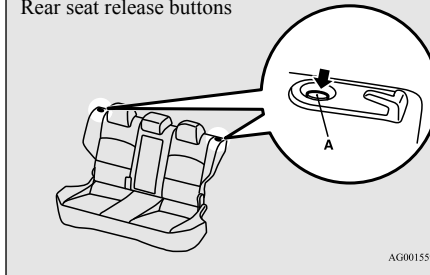

Folding the rear seatbacks forward

N00405701133

The rear seatbacks can be folded forward to extend luggage compartment.

📖 NOTE

- Before folding the rear seatbacks forward, make sure that the arm rest is stowed and the head restraints are lowered completely.
- You can separately fold the right and left side of the seatback.

Luggage compartment levers

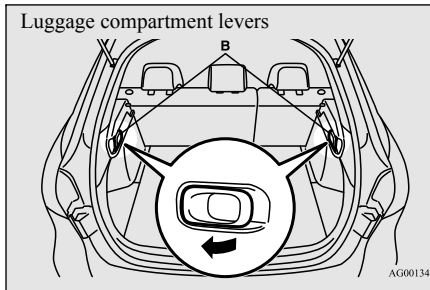

2. The seatbacks fold forward.
Confirm that the seatback locks securely when it is returned.

⚠ WARNING

- When folding the rear seat, make sure no one is on the seat. The seatback will fall forward rapidly and could cause serious injury.
- After returning the seatbacks to their upright positions, make sure that the seatbacks are locked in place and firmly secured. Also check to be sure that the rear seat belts are in front of the seatbacks, and not caught behind the seatbacks.

1. Push the rear seat release button (A) to manually fold the rear seatback forward, or pull the luggage compartment lever (B) to automatically fold the seatback forward.

Seat belts

N00406000439

Seat belts are installed in your vehicle to help reduce the risk of injury to the driver and passenger in the event of an accident. Always use the provided seat belts. Carefully review the following information for proper seat belt usage.

⚠ WARNING

- To help reduce the risk of injury or death in an accident, seat belts and child restraint systems must always be used. Refer to “Child restraint systems” on page 4-14 for additional information.
- Never use one seat belt for more than one person.
- Never carry more people in your vehicle than there are seat belts.
- Always adjust the seat belt for a snug fit.
- Always place the shoulder belt over your shoulder and across your chest. Never put it behind you or under your arm.
- Always wear the lap belt as low as possible across your hips, not around your waist.
- Never modify or alter the seat belts in your vehicle.

⚠ WARNING

- To reduce the risk to the driver of serious injury or death during deployment of the driver’s airbag, always properly wear the seat belt and adjust the driver’s seat as far back as possible while maintaining a position that still enables you to fully apply the pedals, easily control the steering wheel, and safely operate the vehicle.
- To reduce the risk to a front seat passenger of serious injury or death from a deploying airbag, make sure the passenger always wears the seat belt properly, remains seated all the way back and upright in their seat, and moves the seat as far back as possible. Refer to “Supplemental Restraint System (SRS) - airbag” on page 4-21 for additional information.
- Never hold an infant or child in your arms or on your lap when riding in this vehicle even when you are wearing your seat belt. Never place any part of the seat belt you are wearing around an infant or child. Failure to follow these simple instructions creates a risk of serious injury or death to your child in the event of an accident or sudden stop.

⚠ WARNING

- Children 12 years old and under should always ride in the rear seat and be properly restrained. This reduces their risk of serious injury or death in an accident, especially due to a deploying front passenger airbag. Refer to “Child restraint systems” on page 4-14 for additional information.
- Any child who is too small to properly wear a seat belt must be properly restrained in an appropriate child restraint system. Children 12 years old and under should be seated only in the rear seat to reduce their risk of serious injury or death in an accident, especially from the deployment of a front passenger airbag.
- Infants **MUST** be placed in a rear-facing child safety seat and positioned in the rear seat.
- In the event of an accident, all seat belt assemblies, including retractors and attachment hardware, should be inspected by an authorized Mitsubishi Motors dealer to determine whether replacement is necessary.

4

Seat belt instructions

N00406201470

All seats are equipped with a seat belt which uses one combined lap-and-shoulder belt with an emergency locking retractor.

Seat and restraint systems 4-9

Seat belts

This system is designed to provide both comfort and safety. It permits full extension and automatic retraction of the belts during normal vehicle operation. A sensing device inside the belt retractor is designed to lock the retractor in the event of a sudden change in the vehicle's motion.

4

NOTE

- For instructions on installing a child restraint system using a seat belt, refer to “Installing a child restraint system using the seat belt” on page 4-19.

1. Occupants should always sit back in their seats with their backs against the upright seatback. To reduce the risk of serious injury or death during deployment of the airbag, adjust the driver's seat as far back as possible while maintaining a position that still enables you to fully apply the pedals, easily control the steering wheel, and safely operate the vehicle. The front passenger seat should also be moved as far back as possible. Refer to “Supplemental Restraint System (SRS) - airbag” on page 4-21. Also refer to “To adjust the seat forward or backward” on page 4-3.

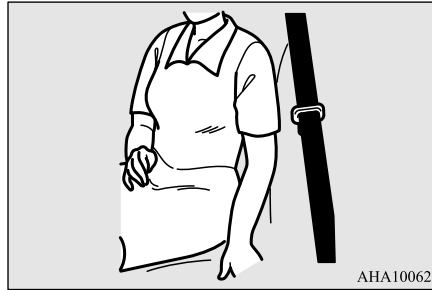

WARNING

- **To reduce the risk of serious injury or death in the event of an accident or sudden stop, all seatbacks should be kept in the upright position while the vehicle is in motion.**
Seat belt performance during an accident can be adversely affected if the seatbacks are reclined. The more a seatback is reclined, the more likely seat belt performance will be adversely affected. If the seat belt is not properly positioned against the body during an accident, there is increased risk you will slide under the belt and receive serious injury or death.

2. Grasp the latch plate and slide it up the webbing so that it easily pulls across your body.



3. Pull the seat belt out slowly while holding the latch plate. Push the latch plate into the buckle until you hear a “click”. Pull up on the belt to be sure the latch plate is locked securely in the buckle.



NOTE

- If the seat belt locks up and cannot be pulled out, pull it once with force and let it retract all the way. Then, pull the belt out slowly once again.

4. The lap part of the belt must always be worn low and snug across the hips. Pull up on the shoulder portion of the belt to take up any slack in the lap belt.



NOTE

- With the exception of the seat belt for the driver, the seat belts in all other seating positions are equipped with an Automatic Locking Retractor (ALR) function. If you pull the seat belt fully out of the retractor, the retractor will switch to its ALR child restraint installation function (see page 4-19). When the ALR function has been activated, the seat belt will only retract. If this happens, let the belt fully retract, then pull the seat belt back out, repeating steps 1 through 4.

WARNING

- Be sure the lap belt portion fits snugly and is worn as low as possible across the hips, not around the waist. Failure to follow this instruction will increase the risk of serious injury or death in the event of an accident.
- Be sure the seat belt webbing is not twisted when worn. Twisted webbing may adversely affect seat belt performance.

5. To release the belt, press the button on the buckle and allow the belt to retract. If the belt does not retract smoothly, pull it out and check for kinks or twists in the webbing. Then make sure it remains untwisted as it retracts.

Seat belt warning

N00409100011

Driver's seat belt reminder/warning light and display

N00409200025

4

Warning light



Warning display type 1



Warning display type 2



A tone and warning light are used to remind the driver to fasten the seat belt. If the ignition switch is turned to the "ON" position without the driver's seat belt being fastened, a warning light will come on and a tone will sound for approximately 6 seconds to remind you to fasten your seat belt.

Seat belts

If you then drive with the seat belt unfastened for longer than a minute from when the ignition switch was turned on, the warning light will come on and blink repeatedly and the tone will sound intermittently.

4

The warning light and the tone will stop after approximately 90 seconds.

If you then repeatedly stop and start your vehicle with the seat belt unfastened, the warning light/display and tone will remind you to fasten your seat belt every time the vehicle starts moving. You will also be reminded to fasten your seat belt in this way when you remove your seat belt while driving. The warning light and the tone go off when the seat belt is fastened.

⚠ WARNING

- In order to reduce the risk of serious injury or death in an accident, always wear your own seat belt. Do not allow anyone to ride in your vehicle unless he or she is also seated and wearing a seat belt. Children should additionally be restrained in a secure child restraint system.

📖 NOTE

- At the same time, “FASTEN SEAT BELT” will be displayed on the information screen in the multi-information display.

Front passenger seat belt warning light

N00409300013

The front passenger seat belt warning light is located in the instrument panel.

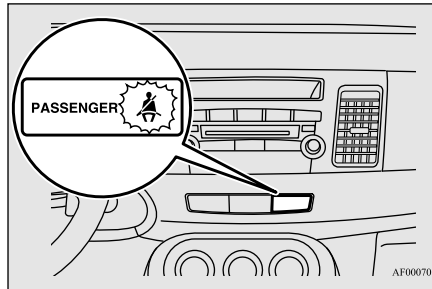

When the ignition switch is turned to the “ON” position, this indicator normally comes on and goes off a few seconds later.

The light comes on when a person sits on the front passenger seat but does not fasten the seat belt. It goes off when the seat belt is subsequently fastened.

⚠ WARNING

- Do not install any accessory or sticker that makes the light difficult to see.

Adjustable seat belt shoulder anchor (front seats)

N00406300269

To move the anchor down, press the lock knob (A) and slide the anchor down to the desired position.

To move the anchor up, slide the anchor up to the desired position.

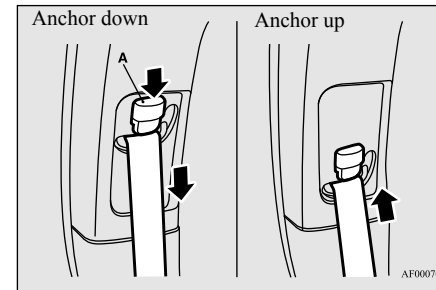

⚠ WARNING

- Always adjust the shoulder belt anchor so that the shoulder belt is positioned across the center of your shoulder without touching your neck. The shoulder belt should not be able to fall off your shoulder. Failure to follow this instruction can adversely affect seat belt performance and increase the risk of serious injury or death in the event of an accident.

WARNING

- Adjust the shoulder belt anchor only when the vehicle is not in motion.
- Make sure the anchor is securely locked in position after adjusting it.

Seat belt extender

N00406701215

When your seat belt, even fully extended, is not long enough, a seat belt extender must be obtained. The extender may be used for either of the front seats.

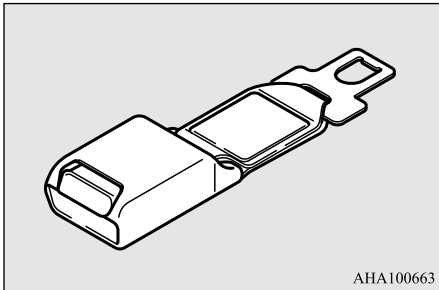

AHA100663

WARNING

- The extender should only be used if the existing belt is not long enough. Anyone who can use the standard seat belt should not use an extender. Unnecessary use of an extender can adversely affect seat belt performance in an accident.

WARNING

- When not required, the extender must be removed and stowed.

Seat belt use during pregnancy

N00406800121

Seat belts work for everyone, including pregnant women. Like all occupants, pregnant women are more likely to be seriously injured or killed in an accident if they do not wear seat belts.

WARNING

- To reduce the risk of serious injury or death to pregnant women and unborn children in an accident, pregnant women should always wear a seat belt. The lap portion of the seat belt should be worn snug and low across the hips and below the rounding. Consult your doctor if you have any additional questions or concerns.

Seat belt pre-tensioner and force limiter systems

N00417700612

The driver's and front passenger's seats each have a seat belt equipped with a pre-tensioner system.

Seat belt use during pregnancy

Pre-tensioner system

The driver and front passenger seat belts are equipped with a seat belt pre-tensioner system. In a moderate-to-severe frontal or side collision, the pre-tensioner system operates simultaneously with the deployment of the front airbags or side airbags and curtain airbags.

The seat belt pre-tensioners are located within the seat belt retractors (A). When activated, the pre-tensioners quickly draw back seat belt webbing and increase seat belt performance.

4

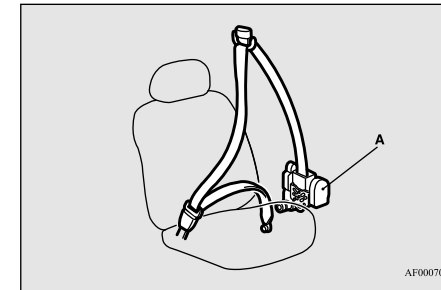

AF0007031

The seat belt pre-tensioner system includes the following components:

Child restraint systems

4

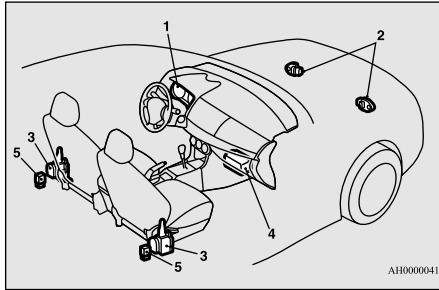

- 1- SRS warning light
- 2- Front impact sensors
- 3- Seat belt pre-tensioners
- 4- Airbag control unit
- 5- Side impact sensors

The airbag control unit monitors the readiness of the electronic parts of the system whenever the ignition switch is in the “ON” or “START” position. These include all of the items listed above and all related wiring.

The pre-tensioner seat belt system will operate only when the ignition switch is in the “ON” or “START” position.

When the seat belt pre-tensioners activate, some smoke is released and a loud noise will be heard. The smoke is not harmful, but care should be taken not to intentionally inhale it, as it may cause some temporary irritation to people with respiratory problems.

The pre-tensioners activate in the event of a moderate-to-severe frontal or side impact, even if the seat belt is not being worn. The seat belt pre-tensioners may not activate in certain types of collisions, even though the vehicle may appear to be severely damaged. Such non-activation does not mean something is wrong with the seat belt pre-tensioner system, but rather that the collision forces were not severe enough or not of the type to activate the system.

WARNING

- **The seat belt pre-tensioner system is designed to work only once. After the seat belt pre-tensioners have been activated, they will not work again. They must promptly be replaced and the entire seat belt pre-tensioner system inspected by an authorized Mitsubishi Motors dealer.**

SRS warning

This warning tells you if there is a problem involving the SRS airbags and the pre-tensioner seat belts. Refer to “SRS warning light/display” on page 4-27.

Force limiter system

N00408900113

In the event of an accident, the seat belt force limiter system will help reduce the force applied to the driver and front seat passenger.

Child restraint systems

N00407101782

When transporting infants or small children in your vehicle, an appropriate child restraint system must always be used. This is required by law in the U.S. and Canada.

Child restraint systems specifically designed for infants and small children are offered by several manufacturers. Choose only a child restraint system with a label certifying that it complies with Federal Motor Vehicle Safety Standard 213 (FMVSS 213) or Motor Vehicle Restraint Systems and Booster Seats Safety Regulations (RSSR). Look for the manufacturer’s statement of compliance on the box and child restraint system itself.

The child restraint system should be appropriate for your child’s weight and height, and should properly fit your vehicle’s seat.

For detail information, refer to the instruction manual accompanying the child restraint system.

Guidelines for child restraint system selection

All children should be properly restrained in a restraint device that offers the maximum protection for their size and age.

Be sure to check local, state, or provincial requirements for child size and age that may vary from the recommendations listed below.

- Children less than 1 year old and who weigh 22 pounds (10 kg) or less **MUST** ride in a rear-facing child safety seat that **MUST ONLY** be used in the rear seat.
- Children older than 1 year of age and who weigh less than 40 pounds (18 kg) or who are less than 40 inches (100 cm) tall must be in a forward-facing restraint used only in the rear seat.
- Children who weigh more than 40 pounds (18 kg) or who are more than 40 inches (100 cm) tall, regardless of age, should use a suitable child seat or a booster seat in the rear seat until the vehicle's lap/shoulder belt fits them properly.

⚠ WARNING

- All children must be seated in the rear seat, and properly restrained. Accident statistics show that children of all sizes and ages are safer when properly restrained in the rear seat, rather than in the front seat.
- Any child who is too large to use a child restraint system should ride in the rear seat and wear the lap and shoulder belt properly. The shoulder belt must be positioned over the shoulder and across the chest, not across their neck, and with the lap belt positioned low on the child's hips, not across their stomach. If necessary, a booster seat should be used to help achieve a proper seat belt fit. Follow the booster seat manufacturer's instructions. Only use a booster seat that is certified as complying with Federal Motor Vehicle Safety Standards or Motor Vehicle Restraint Systems and Booster Seats Safety Regulations.
- Never hold an infant or child in your arms or on your lap when riding in this vehicle, even when you are wearing your seat belt. Never place any part of the seat belt you are wearing around an infant or child. Failure to follow these simple instructions creates a risk of serious injury or death to your child in the event of an accident or sudden stop.

Child restraint systems



4

⚠ WARNING

- Your vehicle is also equipped with a front passenger airbag. Never put **REAR-FACING CHILD RESTRAINT SYSTEMS** or **INFANT RESTRAINT SYSTEMS** in the front passenger seat. This places the infant too close to the passenger airbag. During deployment of the airbag, the infant can be seriously injured or killed. Rear-facing child restraint systems or infant restraint systems must only be used in the rear seat.

Child restraint systems

4



⚠ WARNING

● **FRONT-FACING CHILD RESTRAINT SYSTEMS** should be used in the rear seat whenever possible. If they must be used in the front passenger seat, move the seat to the most rearward position and make sure the child stays in the child restraint system, properly restrained. Failure to follow these instructions could result in serious injury or death to the child.



4-16 Seat and restraint systems

⚠ WARNING

- It is important to use an approved rear-facing infant restraint until the infant is one year old (unless the infant outgrows the seat sooner). This allows the infant's neck and spine to develop enough to support the weight of their head in the event of an accident.
- When installing a child restraint system, follow the instructions provided by the manufacturer and follow the directions in this manual. Failure to do so can result in serious injury or death to your child in an accident or sudden stop.
- After installation, push and pull the child restraint system back and forth, and side to side, to see that it is firmly secured. If the child restraint system is not installed securely, it may cause injury to the child or other occupants in the event of an accident or sudden stop.
- When not in use, keep your child restraint system secured with the seat belt, or remove it from the vehicle, in order to prevent it from being thrown around inside the vehicle during an accident.

📖 NOTE

- Before purchasing a child restraint system, try installing it in the rear seat to make sure there is a good fit. Because of the location of the seat belt buckles and the shape of the seat cushion, it may be difficult to securely install some manufacturer's child restraint systems. If the child restraint system can be pulled forward or to either side easily on the seat cushion after the seat belt has been tightened, choose another manufacturer's child restraint system.
- Depending on the seating position in the vehicle and the child restraint system that you have, the child restraint system can be attached using one of the following two methods:
- To the lower anchorage in the rear seat ONLY if the child restraint system is compatible with the LATCH system (See page 4-17).
 - To the seat belt (See page 4-19).

Installing a child restraint system using the LATCH (Lower Anchors and Tethers for children) system

N00418800115

Lower anchor locations

The outboard seating positions in the rear seat of your vehicle are equipped with lower anchors for attaching child restraint systems compatible with the LATCH system.

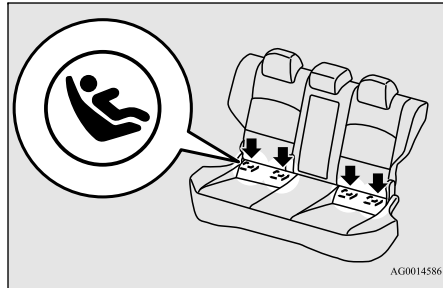

AG0014586

NOTE

- The symbols on the seatback show the location of the lower anchor points.

Tether anchor locations

N00418900145

Your vehicle has 3 attachment points located on the back of the seatbacks. These are for securing a child restraint system tether strap to each of the 3 rear seating positions in your vehicle.

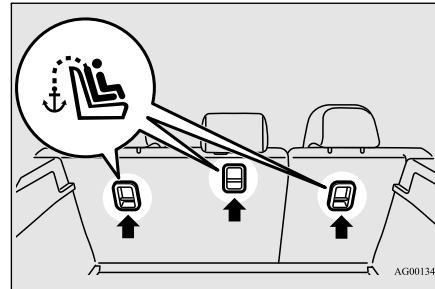

AG0013433

Examples of child restraint systems compatible with the LATCH system

N00419000185

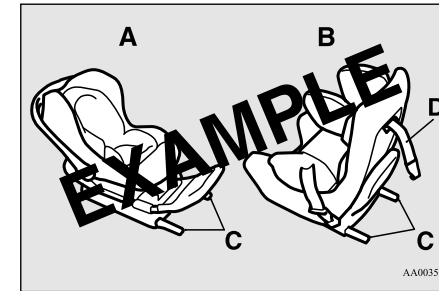

AA0035044

- A- Rear-facing child restraint system
- B- Front-facing child restraint system
- C- Child restraint system lower anchor connectors
- D- Tether strap (These are only examples.)

4

Using the LATCH system

N00419100199

1. In order to securely fasten the tether strap, remove the head restraint from the location where you wish to install the child restraint system.

Child restraint systems

4

2. Push the anchor connectors (A) on the child restraint system into the slits (B) in accordance with the instructions provided by the child restraint system manufacturer. Remember, the lower anchors (E) provided with your vehicle are designed to secure suitable child restraint systems compatible with the LATCH system in the rear seat only.

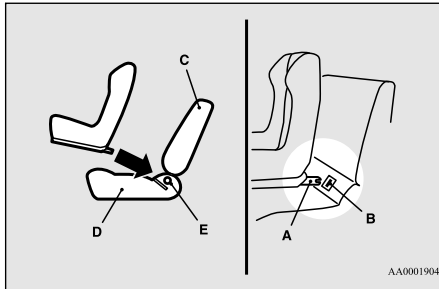

- A- Connector
 B- Slit
 C- Vehicle seatback
 D- Vehicle seat cushion
 E- Lower anchor

NOTE

- In order to secure a child restraint system compatible with the LATCH system, use the lower anchor points in the outboard positions of the rear seat. It is not necessary to use the vehicle's seat belt. The vehicle's seat belt, however, **MUST** be used to secure a child restraint system in the center position of the rear seat.

WARNING

- If there is any foreign material in or around the lower anchors, remove it before installing the child restraint system. Also, make sure the seat belt is away from, not looped through or otherwise interfering with, the child restraint system. If foreign matter is not removed and/or the seat belt interferes with the child restraint system, the child restraint system will not be secured properly, could detach and move forward in the event of sudden braking or an accident, and could result in injury to the child or other vehicle occupants.
- When the vehicle is moving, do not adjust the seat where the child restraint system is installed.

3. Remove the rear shelf panel from the vehicle.

(Refer to "Rear shelf panel" on page 5-161.)

4. Latch the tether strap hook (F) of the child restraint system to the tether anchor bar (G) and tighten the tether strap so it is securely fastened.

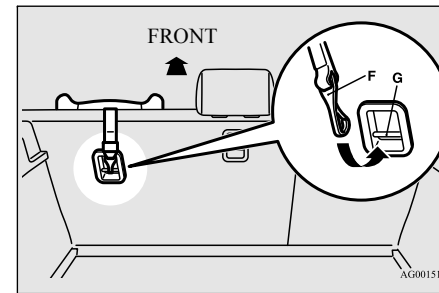

5. Push and pull the child restraint system in all directions to be sure it is firmly secured.

WARNING

- Child restraint system tether anchors are designed only to withstand loads from correctly fitted child restraint systems. Under no circumstances are they to be used for adult seat belts, or harnesses, or for attaching other items or equipment to the vehicle.

Installing a child restraint system using the seat belt (with emergency/automatic locking mechanism)

N00407301511

With the exception of the driver, the seat belt in all other seating positions can be converted from normal Emergency Locking Retractor (ELR) mode to Automatic Locking Retractor (ALR) mode. This means that when you pull the seat belt fully out of the retractor, the retractor will switch to its ALR child restraint installation function. Always use the ALR child restraint installation function when you install a child restraint system using the seat belt.

Children 12 years old and under should always be restrained in the rear seat, whenever possible, although the front passenger seat belt can also be converted to ALR mode.

WARNING

- When you install a child restraint system using the seat belt, always make sure the retractor has been switched to the ALR child restraint installation function. The ALR function will keep the child restraint system tightly secured to the seat. Failure to convert the retractor to the ALR function may allow the child restraint system to move forward during sudden braking or an accident, resulting in serious injury or death to the child or other occupants.

Installation

1. Place the child restraint system on the seat where you wish to install it.
To help assure proper fitting of the child restraint system, always remove the head restraint.
2. Route the seat belt through the child restraint system according to the instructions provided by the child restraint system manufacturer. Then insert the seat belt latch plate into the buckle. Make sure you hear a “click” when you insert the latch plate into the buckle.

Child restraint systems

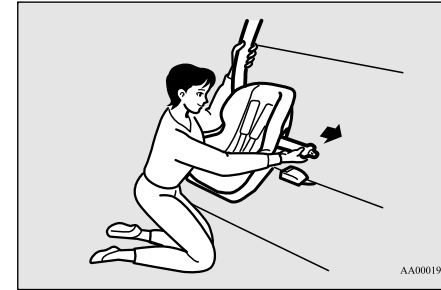

4

3. To activate the ALR child restraint installation function, slowly pull the shoulder part of the belt all the way out of the retractor until it stops. Then let the belt feed back into the retractor.

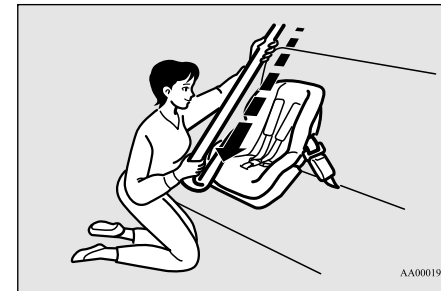

Child restraint systems

4

4. After the belt has retracted, tug on it. If the belt is in the ALR function, you will not be able to pull it out. If the webbing can be pulled out from retractor, the ALR function has not been activated and you will need to repeat steps 3 and 4.
5. After confirming that the belt is locked, grab the shoulder part of the belt near the buckle and pull up to remove any slack from the lap part of the belt allowing the slack to feed into the retractor. Remember, if the lap belt portion is not tight, the child restraint system will not be secure. It may help to put your weight on the child restraint system and/or push on its seat-back while pulling up on the belt (see illustration).

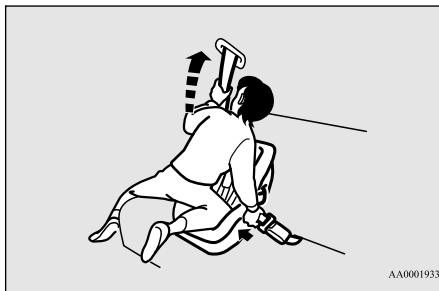

If your child restraint system requires the use of a tether strap, fasten the tether strap in accordance with the following procedures.

6. Remove the rear shelf panel from the vehicle. (Refer to “Rear shelf panel” on page 5-161.)
7. Latch the tether strap hook (A) of the child restraint system to the tether anchor bar (B) and tighten the tether strap so it is securely fastened.

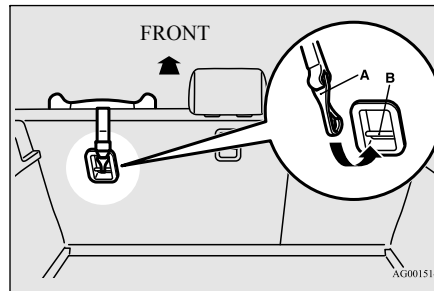

WARNING

- Child restraint system tether anchors are designed only to withstand loads from correctly fitted child restraint systems. Under no circumstances are they to be used for adult seat belts, or harnesses, or for attaching other items or equipment to the vehicle.

8. Before putting your child in the restraint, push and pull the restraint in all directions to be sure it is firmly secured. Do this before each use. If the child restraint system is not firmly secure, repeat steps 1 through 7.
9. To remove a child restraint system from the vehicle and deactivate the ALR mode, remove the child from the restraint. Unlatch the buckle. Then remove the belt from the restraint and let the belt fully retract.
10. Reinstall the head restraint.
Refer to “Head restraints” on page 4-5.

Children who have outgrown child restraint systems

N00407601660

Children who have outgrown a child restraint system should be seated in the rear seat and wear the seat belt. If the shoulder belt crosses their face or neck, and/or the lap belt crosses their stomach, a commercially available booster seat must be used, to raise the child so that the shoulder belt crosses their shoulder and the lap belt remains positioned low across their hips. The booster seat should fit the vehicle seat and have a label certifying compliance with Federal Motor Vehicle Safety Standards or Motor Vehicle Restraint

Systems and Booster Seats Safety Regulations.

⚠ WARNING

- Any child who is too small to properly wear a seat belt must be properly restrained in an appropriate child restraint system, to reduce their risk of serious injury or death in an accident.
- A child should never be left unattended in, or unsupervised, around your vehicle. When you leave the vehicle, always take the child out as well.
- Children can die from heat stroke if left or trapped inside the vehicle, especially on hot days.
- Keep your vehicle locked when not in use. Keep your vehicle keys away from children.
- Never allow children to play in the luggage compartment of your vehicle.

Maintenance and inspection of seat belts

N00407000221

The seat belt webbing may be cleaned with mild soap or detergent solution. Do not use an organic solvent. Allow the belts to dry in the shade. Do not allow them to retract until completely dry. Do not attempt to bleach or re-

dye the belts. The color may rub off and the webbing strength may be affected.

Regularly check your seat belt buckles and their release mechanisms for positive engagement and release of the latch plate. Check the retractors for automatic locking when in the Automatic Locking Retractor function.

The entire seat belt assembly should be replaced if the webbing shows any obvious cuts, tears, increase in thickness in any section of the webbing from broken fibers, or severe fading from sunlight. All of these conditions indicate a weakening of the belt, which may adversely affect seat belt performance in an accident.

⚠ WARNING

- Do not attempt to repair or replace any part of the seat belt assemblies. This work should be done by an authorized Mitsubishi Motors dealer. Failure to have an authorized Mitsubishi Motors dealer perform the work could reduce the effectiveness of the belts and could result in a serious injury or death in an accident.

Maintenance and inspection of seat belts

Supplemental Restraint System (SRS) - airbag

N00407701821

4

This vehicle is equipped with a Supplemental Restraint System (SRS), which includes airbags for the driver and passengers.

The SRS front airbags are designed to supplement the primary protection of the driver and front passenger seat belt systems by providing those occupants with protection against head and chest injuries in certain moderate to severe frontal collisions.

The SRS front airbags, together with sensors at the front of the vehicle and sensors attached to the front seats, form an advanced airbag system.

The SRS driver's knee airbag is designed to supplement the primary protection of the driver's seat belt system. It can reduce the forward movement of the driver's lower legs and provide increased overall body protection in certain moderate to severe frontal collisions.

The SRS side airbags and the curtain airbags are also designed to supplement the seat belts. The SRS side airbags provide the driver and front passenger with protection against chest injuries by deploying the bag on the side impacted in moderate to severe side impact

Supplemental Restraint System (SRS) - airbag

collisions. The SRS curtain airbags provide the driver and passengers on the front seat and rear outboard seat with protection against head injuries by deploying a bag on the side impacted in moderate to severe side impact collisions.

4

The SRS airbags are NOT a substitute for use of the seat belts. For maximum protection in all types of accidents, seat belts must ALWAYS be worn by everyone who drives or rides in this vehicle (with infants and small children in an appropriate child restraint system in the rear seat, and older children buckled in the rear seat). Refer to “Child restraint systems” on page 4-14.

WARNING

- IT IS VERY IMPORTANT TO ALWAYS WEAR YOUR SEAT BELT PROPERLY EVEN WITH AN AIRBAG.

WARNING

- Seat belts help keep the driver and passengers properly positioned. This reduces the risk of injury in all collisions, and reduces the risk of serious injuries or death when the airbags inflate. During sudden braking just before a collision, an unrestrained or improperly restrained driver or passengers can move forward into direct contact with, or within close proximity to, the airbag when it begins to inflate. The beginning stage of airbag inflation is the most forceful and can cause serious injuries or death if the occupant comes in contact with the airbag at this time.
- Seat belts reduce the risk of injury in rollovers, rear impact collisions, and in lower-speed frontal collisions, because the airbags are not designed to inflate in those situations.
- Seat belts reduce the risk of being thrown from your vehicle in a collision or rollover.
- IT IS VERY IMPORTANT TO BE PROPERLY SEATED.
 - A driver or front passenger sitting too close to the steering wheel or instrument panel during airbag deployment can be seriously injured or killed.

WARNING

- Airbags inflate very quickly and with great force. If the driver and front passenger are not properly seated and restrained, the airbag may not provide the proper protection and can cause serious injuries or death when it inflates.
- To reduce the risk to the driver of serious injury or death due to a deploying driver's airbag, always properly wear your seat belt and adjust the driver's seat as far back as possible, maintaining a position that still allows the driver to have good control of the steering wheel, brake, accelerator, and other vehicle controls.
- To reduce the risk to the front passenger of serious injury or death from a deploying passenger's airbag, make sure the passenger always wears the seat belt properly, remains seated upright and all the way back in the seat, and positions the seat as far back as possible.
- Seat all infants and children in the rear seat, properly restrained in an appropriate child restraint system.
- Airbags inflate very quickly and with great force. Do not sit on the edge of the seat or sit with your lower legs too close to the instrument panel, or lean your head or chest close to the steering wheel or the instrument panel.
- Do not put your feet or legs on or against the instrument panel.

Supplemental Restraint System (SRS) - airbag

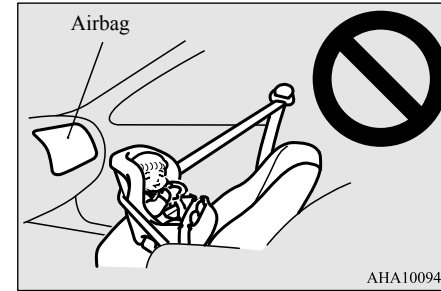
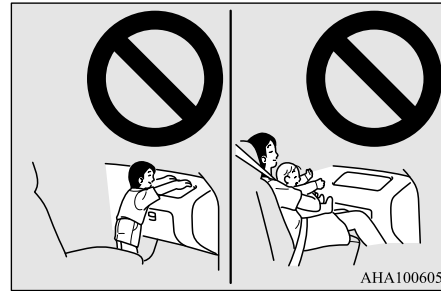
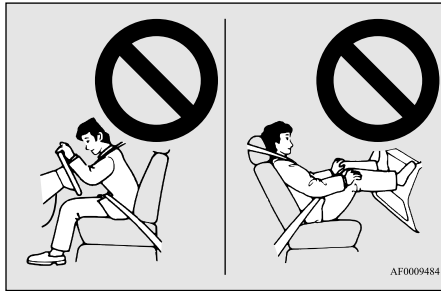

4

⚠ WARNING

- Infants and small children should never ride unrestrained, or lean against the instrument panel. They should never ride held in your arms or on your lap. They can be seriously injured or killed in an accident, especially when the airbags inflate. Infants and children should be properly seated in the rear seat in an appropriate child restraint system. Refer to “Child restraint systems” on page 4-14.

⚠ WARNING

- NEVER put REAR-FACING CHILD RESTRAINT SYSTEMS or INFANT RESTRAINT SYSTEMS in the front passenger seat. This places the infant too close to the passenger airbag. During deployment of the airbag, the infant can be seriously injured or killed. Rear-facing child restraint systems or infant restraint systems must only be used in the rear seat.

⚠ WARNING

- FRONT-FACING CHILD RESTRAINT SYSTEMS should be used in the rear seat whenever possible. If they must be used in the front passenger seat, move the seat to the most rearward position and make sure the child stays in the child restraint system, properly restrained. Failure to follow these instructions could result in serious injury or death to the child.



Supplemental Restraint System (SRS) - airbag

⚠ WARNING

- Older children should be seated in the rear seat with their seat belt properly worn, and with an appropriate booster seat if needed. Refer to “Children who have outgrown child restraint systems” on page 4-20.

4

How the Supplemental Restraint System works

N00407801558

The SRS includes the following components:

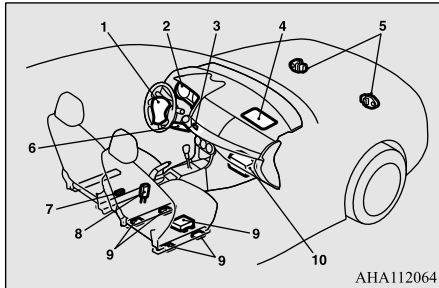

- 1- Driver's airbag
- 2- SRS warning light
- 3- Passenger's airbag off indicator
- 4- Passenger's front airbag
- 5- Front impact sensors
- 6- Driver's knee airbag
- 7- Driver's seat position sensor

- 8- Seat belt buckle switch (passenger's side only)
- 9- Passenger's seat weight sensors
- 10- Airbag control unit

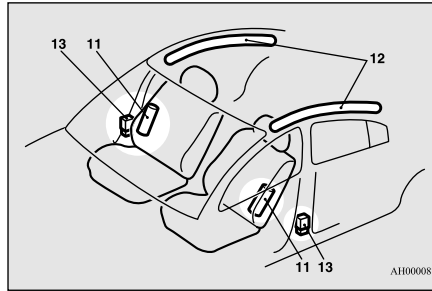

- 11- Side airbag modules
- 12- Curtain airbag modules
- 13- Side impact sensors

The airbag control unit monitors the readiness of the electronic parts of the system whenever the ignition switch is in the “ON” or “START” position. These include all of the items listed above and all related wiring.

The airbags will operate only when the ignition switch is in the “ON” or “START” position.

When the impact sensors detect a front or side impact sufficient to deploy the airbag(s), the appropriate airbag(s) will be deployed.

When airbags deploy, some smoke is released accompanied by a loud noise. The smoke is not harmful, but do not intentionally inhale the smoke as it may cause temporary irritation to people with respiratory problems.

After deployment, the airbags will quickly deflate, so quickly that some people may not even realize the airbags inflated.

Airbag inflation does not prevent the driver from seeing or being able to steer the vehicle, and does not prevent people from leaving the vehicle.

⚠ CAUTION

- Airbags inflate very quickly and with great force. In certain situations, contact with an inflating airbag may cause small cuts, abrasions, and bruises. Refer to “Supplemental Restraint System (SRS) - airbag” on page 4-21.

Event Data Recording

N00418600230

This vehicle is equipped with an event data recorder (EDR).

The main purpose of an EDR is to record, in certain crash or near crash-like situations, such as an airbag deployment or hitting a road obstacle, data that will assist in understanding how a vehicle's systems performed.

Supplemental Restraint System (SRS) - airbag

The EDR is designed to record data related to vehicle dynamics and safety systems for a short period of time, typically 30 seconds or less.

The EDR in this vehicle is designed to record such data as:

- How various systems in your vehicle were operating;
- Whether or not the driver and passenger safety belts were buckled/fastened;
- How far (if at all) the driver was depressing the accelerator and/or brake pedal; and,
- How fast the vehicle was traveling.

These data can help provide a better understanding of the circumstances in which crashes and injuries occur.

NOTE

- EDR data are recorded by your vehicle only if a non-trivial crash situation occurs; no data are recorded by the EDR under normal driving conditions and no personal data (e.g., name, gender, age, and crash location) are recorded. However, other parties, such as law enforcement, could combine the EDR data with the type of personally identifying data routinely acquired during a crash investigation.

To read data recorded by an EDR, special equipment is required, and access to the vehicle or the EDR is needed. In addition to the vehicle manufacturer, other parties, such as law enforcement, that have the special equipment, can read the information if they have access to the vehicle or the EDR.

Driver's seat position sensor

N00417900180

The driver's seat position sensor is attached to the seat rail and provides the airbag control unit with information on the seat's fore-aft position. The airbag control unit controls deployment of the driver's front airbag in accordance with the information it receives from this sensor.

If there is a problem involving the driver's seat position sensor, the SRS warning in the instrument panel will come on. Refer to "SRS warning light/display" on page 4-27.

WARNING

- **If the SRS warning comes on, have the vehicle inspected by an authorized Mitsubishi Motors dealer as soon as possible.**
- **Please observe the following instructions to ensure that the driver's seat position sensor can operate correctly.**
 - **Adjust the seat to the correct position, and sit well back against the seatback. Refer to "Front seats" on page 4-3.**

WARNING

- **Do not recline the seatback more than necessary when driving.**
- **Do not place metallic objects or luggage under the front seat.**
- **If the vehicle is involved in a severe impact, have the SRS sensor inspected by an authorized Mitsubishi Motors dealer as soon as possible.**

4**Passenger's seat weight sensors**

N00418000292

The passenger's seat weight sensors are attached to the seat rails and provide the airbag control unit with information regarding the weight on the front passenger seat. The airbag control unit controls deployment of the passenger's front airbag in accordance with the information it receives from this sensor.

The passenger's front airbag will not deploy in an impact when the weight on the seat is sensed to be less than approximately 66 pounds (30 kg). In this case, the passenger's airbag off indicator will come on. Refer to "Passenger's airbag off indicator" on page 4-26.

If there is a problem involving the passenger's seat weight sensors, the SRS warning in the instrument panel will come on. Refer to "SRS warning light/display" on page 4-27.

Supplemental Restraint System (SRS) - airbag

4

WARNING

- If any of the following conditions occur, you should immediately have your vehicle inspected by an authorized Mitsubishi Motors dealer as soon as possible:
 - The SRS warning does not initially come on when the ignition switch is turned to the “ON” or “START” position.
 - The SRS warning does not go out after several seconds.
 - The SRS warning comes on while you are driving.
- To ensure that the passenger’s seat weight sensors can correctly sense the weight being applied to the seat, observe the following instructions. Failure to follow these instructions can adversely affect the performance of the passenger’s airbag system.
 - Adjust the seat to the correct position, and sit well back against the seatback. Refer to “Front seats” on page 4-3.
 - Do not recline the seatback more than necessary.
 - Never have more than one person (adult or child) sitting on the seat.
 - Do not place anything between the seat and the floor console.
 - Do not hang anything on the front passenger’s seatback.
 - Do not remove the head restraints.
 - When attaching a child restraint system, secure it firmly.

WARNING

- Do not place luggage or other objects on the seat.
- Do not use a seat cover or a cushion.
- Do not modify or replace the seat and seat belt.
- Do not place luggage or other objects under the seat.
- Do not place the floor mat on the seat rails.
- Do not expose the sensors to liquids or vapors.
- Do not subject the sensors to shock.
- Do not allow rear-seat occupants to push the front passenger seat with their feet or force the front passenger seat upward.
- Do not allow rear-seat occupants to grasp the front passenger’s seatback or put their arms around it.
- When attaching a child restraint system in the rear seat, make sure it does not interfere with the front seat.
- If the vehicle is involved in a severe impact, have the SRS sensors inspected by an authorized Mitsubishi Motors dealer as soon as possible.

Passenger’s airbag off indicator

N00418100251

The passenger’s airbag off indicator is located in the instrument panel.

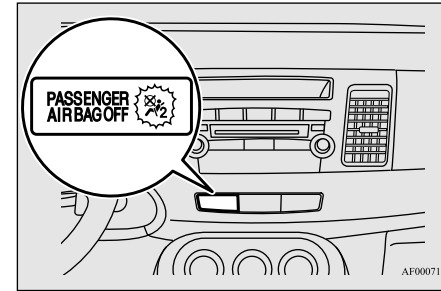

The indicator normally comes on when the ignition switch is turned to the “ON” position and goes out a few seconds later.

In the following situations, the indicator will stay on to show that the passenger’s front airbag is not operational.

- The passenger’s seat weight sensors sense a weight of less than approximately 66 pounds (30 kg) on the front passenger seat.
- The front passenger’s seat is not occupied.

When the weight applied to the front passenger seat is sensed to be approximately 66 pounds (30 kg) or greater, the indicator goes out to show that the passenger’s front airbag is operational.

Supplemental Restraint System (SRS) - airbag

⚠ WARNING

- If any of the following conditions occur, you should immediately have the airbag system in your vehicle inspected by an authorized Mitsubishi Motors dealer as soon as possible:
 - The passenger's airbag off indicator comes on when an adult is sitting on the front passenger seat.
 - The passenger's airbag off indicator does not come on when the front passenger's seat is not occupied.
 - The passenger's airbag off indicator does not come on when the ignition switch is turned to the "ON" position.
 - The passenger's airbag off indicator comes on and goes out repeatedly.
- Do not attach any accessory to your vehicle that makes the passenger's airbag off indicator difficult or impossible to see. You must be able to see the passenger's airbag off indicator and verify the status of the passenger's airbag system.

SRS warning light/display

N00408301635

Warning light



Warning display type 1



Warning display type 2



The system checks itself every time the ignition switch is turned to the "ON" position. The SRS warning light will come on for several seconds and then go out. This is normal and means the system is working properly.

If there is a problem involving one or more of the SRS components, the warning light will come on and stay on. At the same time, the warning display will appear on the information screen in the multi information display.

The SRS warning light/display is shared by the SRS airbag and the seat belt pre-tensioner system.

⚠ WARNING

- If any of the following conditions occur, there may be a problem with the SRS airbags and/or seat belt pre-tensioners, and they may not function properly in a collision or may suddenly activate without a collision:

- Even when the ignition switch is in ON, the SRS warning light does not come on or it remains on.

- The SRS warning light and/or the warning display comes on while driving.

The SRS airbags and seat belt pre-tensioners are designed to help reduce the risk of serious injury or death in certain collisions. If either of the above conditions occurs, immediately have your vehicle checked by an authorized Mitsubishi Motors dealer.

4

Driver's and passenger's front airbag system

N00407900275

The driver's airbag is located under the padded cover in the middle of the steering wheel. The front passenger's airbag is contained in the instrument panel above the glove compartment. The driver's airbag and the front passenger's airbag are designed to deploy at the same time. However, the front passenger's airbag does not deploy when the front



Supplemental Restraint System (SRS) - airbag

passenger seat is not occupied or when the weight sensor in the front passenger seat senses a weight on the seat of less than approximately 66 pounds (30 kg).



4

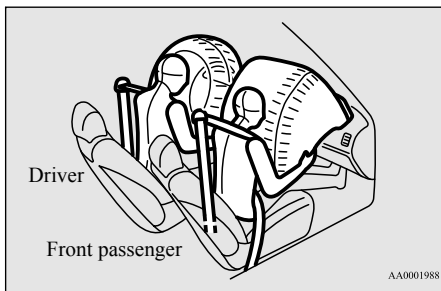

Driver's knee airbag system

N00404500010

The driver's knee airbag is located under the steering wheel. The driver's knee airbag is designed to deploy at the same time as the driver's front airbag.

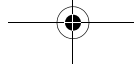

Deployment of front airbags

N00408001632

The front airbags and driver's knee airbag ARE DESIGNED TO DEPLOY when...

4

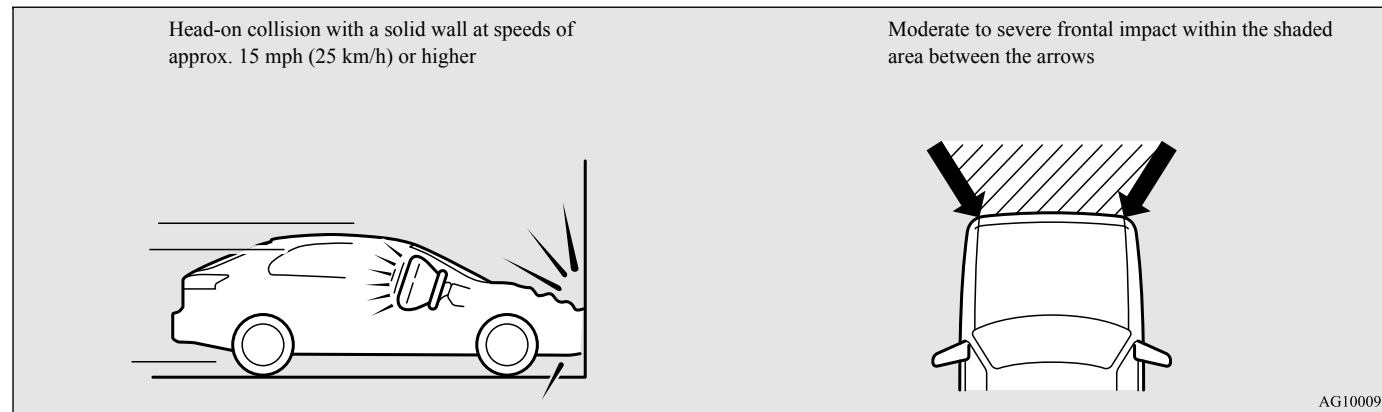

The front airbags and driver's knee airbag are designed to deploy when the vehicle suffers a moderate to severe frontal impact. A typical condition is shown in the illustration to the left.

The front airbags and driver's knee airbag are designed to deploy only in certain moderate to severe frontal collisions within the shaded area between the arrows in the illustration to the right.

The front airbags and driver's knee airbag will deploy if the impact to the vehicle's main structure is above a specific threshold level. The threshold level is approximately 15 mph (25 km/h) for a frontal collision straight into a solid flat wall that does not bend or deform. If the impact to the vehicle's main structure is below this threshold level, the front airbags and driver's knee airbag may not deploy. This threshold level may also be higher if the vehicle hits something that absorbs the impact,

either by bending or moving (for example, another stationary vehicle, a pole or a guard rail).

The beginning stage of airbag inflation is the most forceful, and can cause serious injuries or death if you are too close to the deploying airbag. Accordingly, it is important that you always wear the available seat belt.



Supplemental Restraint System (SRS) - airbag

The front airbags and driver's knee airbag **MAY NOT DEPLOY** when ...

4

In certain types of front collisions, the front airbags and driver's knee airbag may not deploy, even if the deformation of the body seems to be large, because the vehicle's body structure is designed to absorb the impact and deform in order to help protect the occupants. Some typical situations where the front airbags and driver's knee airbag may not deploy are shown in the illustrations.

Because the front airbags and driver's knee airbag do not protect the occupant in all types of frontal collisions, be sure to always wear your seat belts properly.

Collision with a utility pole, tree or other narrow objects



Collision where the vehicle slides under the rear body of a truck



Oblique frontal impact

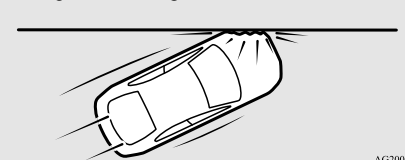

AG2000459

The front airbags and driver's knee airbag **ARE NOT DESIGNED TO DEPLOY** when ...

The front airbags and driver's knee airbag are not designed to deploy in situations where they cannot provide protection to the occupants.

Some typical situations are shown in the illustrations.

Because the front airbags and driver's knee airbag do not protect the occupants in all types of collisions, be sure to always wear your seat belts properly.

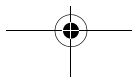

Supplemental Restraint System (SRS) - airbag

Rear end collision to your vehicle



Side collision to your vehicle

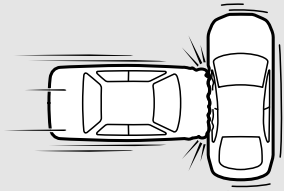

Vehicle rolls onto its side or roof

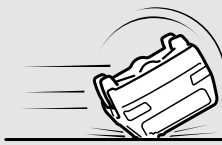

AG2000462

The front airbags and driver's knee airbag **MAY DEPLOY** when

...

The front airbags and driver's knee airbag may deploy if the underside of the vehicle suffers a moderate to severe impact (under-carriage impact). Some typical situations are shown in the illustrations.

Because the front airbags and driver's knee airbag may deploy in certain types of unexpected impacts, as shown in the illustrations, and these unexpected impacts can move you out of position, it is important to always wear your seat belts properly. When worn properly, seat belts can help maintain your distance from the airbags and driver's knee airbag when they begin to inflate. The beginning stage of airbag inflation is the most forceful and can cause serious injury or death if you are close to the deploying airbag.

Collision with an elevated median/island or curb

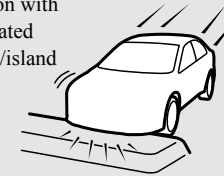

Vehicle travels over a deep hole/pothole

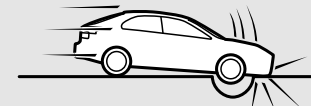

Vehicle drives down a steep slope and hits the ground

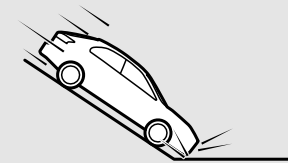

AG2000475

Supplemental Restraint System (SRS) - airbag

4

⚠ WARNING

- Do not attach anything to the steering wheel's padded cover, such as trim material, badges, etc. These could strike and injure an occupant if the airbag inflates.
- Do not set anything on, or attach anything to, the instrument panel above the glove compartment. Such items could strike and injure an occupant if the airbag inflates.

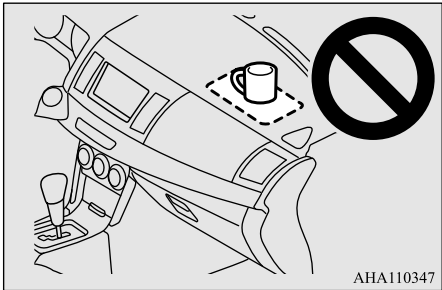

⚠ WARNING

- Do not attach accessories to, or put them in front of, the windshield. They could restrict the airbag inflation, or strike and injure an occupant, when the airbag inflates.

⚠ WARNING

- Do not attach additional keys or accessories (hard, pointed or heavy objects) to the ignition key. Such objects could prevent the driver's knee airbag from inflating normally or could be propelled to cause serious injury if the airbag inflates.
- Do not attach accessories to the lower portion of the driver's side instrument panel. Such objects could prevent the driver's knee airbag from inflating normally or could be propelled to cause serious injury if the airbag inflates.



⚠ WARNING

- Do not attempt to remove, install, disassemble or repair the SRS airbags.

⚠ WARNING

- Do not place objects, such as packages or pets, between the airbags and the driver or the front passenger. Such objects can adversely affect airbag performance, or cause serious injury or death when the airbag deploys.
- Immediately after airbag inflation, some parts of the airbag system will be hot. Do not touch them. You could be burned.
- The airbag system is designed to work only once. After the airbags deploy, they will not work again. They must promptly be replaced and the entire airbag system must be inspected by an authorized Mitsubishi Motors dealer.

Supplemental Restraint System (SRS) - airbag

Side airbag system

N00408101457

The side airbags (A) are contained in the driver and front passenger seatbacks. The side airbag is designed to inflate only on the side of the vehicle that is impacted, even with no passenger in the front seat.

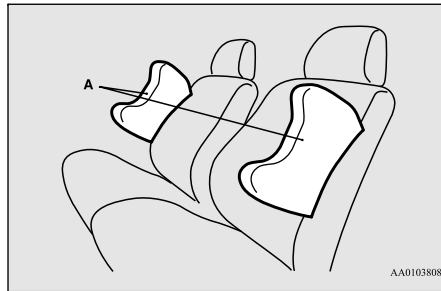

A label is attached to the seatbacks in vehicles with side airbags.

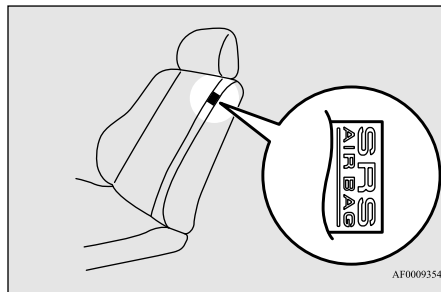

Curtain airbag system

N00419201243

The curtain airbags are contained in the front and rear pillars and roof side rail. The curtain airbag is designed to inflate only on the side of the vehicle that is impacted, even with no passenger in the front seat.

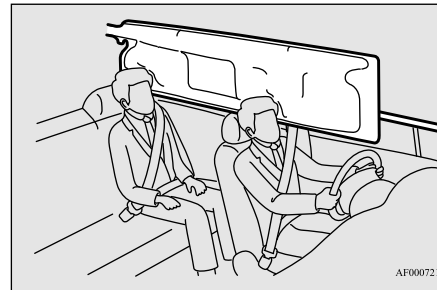

WARNING

- The side airbag and curtain airbag can cause serious injury or death to anyone too close to the airbag when it deploys. To reduce the risk of injury from a deploying side airbag and curtain airbags, all occupants must be properly restrained and seated well back, upright, and in the middle of the seat. Do not lean against the door.



4

WARNING

- In order to reduce the risk of injury from a deploying side airbag, do not allow any rear seat passengers to hold onto the back of either front seat. Special care should be taken with children.
- Do not place any objects near or around the front of either front seatback. Such objects can interfere with proper side airbag deployment and cause injury during deployment of the side airbag.
- Do not place stickers, labels or additional trim on the back of either front seat. They can interfere with proper side airbag deployment.
- Do not install seat covers or re-cover seats that have side airbags. Covers can interfere with proper side airbag deployment and adversely affect side airbag performance.

Supplemental Restraint System (SRS) - airbag

4

⚠ WARNING

● Do not attach a microphone (A) or any other object around the part where the curtain airbag (B) deploys, such as on the windshield, side door glass or front and rear pillars and roof side rail. When the curtain airbag inflates, the microphone or other object may be hurled with great force or the curtain airbag may not inflate correctly, resulting in death or serious injury.

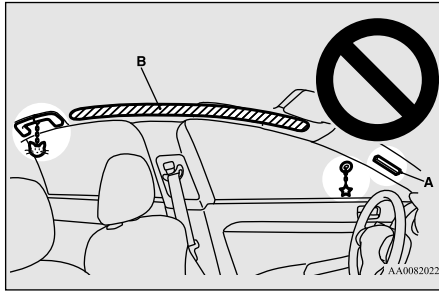

⚠ WARNING

- Do not put a hanger or any heavy or pointed object on the coat hook. If the curtain airbag was activated, any such item could be propelled away with great force and could prevent the curtain airbag from inflating correctly. Hang clothes directly on the coat hook (without using a hanger). Make sure there are no heavy or sharp objects in the pockets of clothes that you hang on the coat hook.
- Never install a rear-facing child restraint system in the front passenger seat. Rear-facing child restraint systems **MUST ONLY** be used in the rear seat.
- Front-facing child restraint systems should also be used **ONLY** in the rear seat. If a front-facing child restraint system must be used in the front passenger seat, move the seat as far back as possible, and make sure that the child stays in the child restraint system, properly restrained and away from the door.
- Do not allow a child to lean against or sit close to the passenger door, even if the child is seated in a child restraint system. The child's head should also not lean against or be close to the section of the seatback where the side airbag and curtain airbag are located. It is dangerous if the side airbag and curtain airbag deploys. Failure to follow all of these instructions could lead to serious injury or death to the child.

⚠ WARNING

- Work done on or in the vicinity of the side airbag and curtain airbag system components should be done only by an authorized Mitsubishi Motors dealer. Improper work methods can cause accidental side airbag and curtain airbag deployment, or render a side airbag and curtain airbag inoperable. Either of these situations can result in serious injury or death.

Deployment of side airbag and curtain airbag

N00408201562

The side airbag and curtain airbag ARE DESIGNED TO DEPLOY when ...

A side airbag and curtain airbag are designed to deploy when the vehicle suffers a moderate to severe side impact to the middle of the passenger compartment. The typical situation is shown in the illustration.

Supplemental Restraint System (SRS) - airbag

Moderate to severe impact to the middle of the vehicle body's side structure

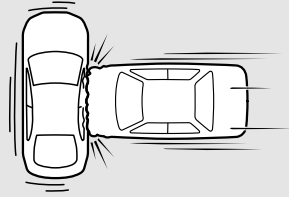

AG0013491

The seat belts in your vehicle are your primary means of protection in an accident. The SRS (Supplemental Restraint System) side airbags and curtain airbags are designed to provide additional protection. Therefore, for your safety and the safety of all occupants, be sure to always wear your seat belts properly.

The side airbag and curtain airbag MAY NOT DEPLOY when ...

In certain types of side collisions, the side airbag and curtain airbag may not deploy, even if the deformation of the body seems to be large, because the vehicle's body structure is designed to absorb the impact and to deform in order to help protect the occupants. Some typical situations where the side airbag and curtain airbag may not deploy are shown in the illustrations.

Because the side airbags and curtain airbags do not protect the occupant in all types of side collisions, be sure to always wear your seat belts properly.

Side impact in an area away from the passenger compartment

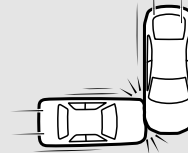

Motorcycle or other similar small vehicle collision with the side of vehicle



Collision with a utility pole, tree or other narrow object

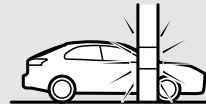

AG2000488

Oblique side impact



Vehicle rolls onto its side or roof



AG3001512

4

The side airbag and curtain airbag ARE NOT DESIGNED TO DEPLOY when ...

The side airbag and curtain airbag are not designed to deploy in situations where they cannot provide protection to the occupants. Typical situations where the side airbags and curtain airbags cannot provide protection are shown in the illustrations below.

Because the side airbags and curtain airbags do not protect the occupants in all types of collisions, be sure to always wear your seat belts properly.

Supplemental Restraint System (SRS) - airbag

4

Head-on collision

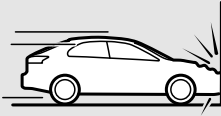

Rear end collision



AG3001525

SRS servicing

N00408500672

⚠ WARNING

- Any maintenance performed on or near the components of the SRS should be performed only by an authorized Mitsubishi Motors dealer. Do not permit anyone else to do any service, inspection, maintenance or repair on any SRS components or wiring. Similarly, no part of the SRS should ever be handled, removed or disposed by anyone except an authorized Mitsubishi Motors dealer.

Improper work methods on the SRS components or wiring could result in an accidental airbag deployment or could make the SRS inoperable. Either of these situations could result in serious injury or death.

- Do not modify your steering wheel or any other SRS component or related vehicle part. For example, replacement of the steering wheel, or modifications to the front bumper or body structure can adversely affect SRS performance and may lead to injury.
- If your vehicle has received any damage, you should have the SRS inspected by an authorized Mitsubishi Motors dealer to make sure it is in proper working order.

⚠ WARNING

- Do not modify your front seats, center pillar or center console. Such modifications can adversely affect SRS performance and may lead to injury. Also, if you discover any tear or open seam in the seat fabric near the side airbag, have the seat inspected by an authorized Mitsubishi Motors dealer.
- If you find a crack in or damage to the front pillar, rear pillar, or roof side rail where the curtain airbag is located, have the SRS inspected by an authorized Mitsubishi Motors dealer.

📖 NOTE

- When you transfer ownership of the vehicle to another person, we urge you to alert the new owner that it is equipped with the SRS and refer that owner to the applicable sections in this owner's manual.
- If you decide to junk or scrap your vehicle, we urge you to first take it to an authorized Mitsubishi Motors dealer so that the SRS can be made safe for disposal.
- If any of the following parts needs to be modified for use by a handicapped person, the advanced airbag system will be greatly affected. Please consult an authorized Mitsubishi Motors dealer for assistance.
 - Driver's seat
 - Front passenger seat
 - Front seat belt

Supplemental Restraint System (SRS) - airbag

NOTE

- Steering wheel
- Instrument panel

[For vehicles sold in U.S.A.]

To contact Mitsubishi Motors North America, Inc.
call 1-888-648-7820 or write to:
Mitsubishi Motors North America, Inc.
Customer Relations Department
P. O. Box 6400
Cypress, CA 90630-0064

[For vehicles sold in Canada]

To contact Mitsubishi Motor Sales of Canada, Inc.
call 1-888-576-4878 or write to:
Mitsubishi Motor Sales of Canada, Inc.
Customer Relations Department
P.O. Box 41009
4141 Dixie Road
Mississauga, ON L4W 5C9

[For vehicles sold in Puerto Rico]

To contact Mitsubishi Motor Sales of Caribbean, Inc.
call 1-787-251-8715 or write to:
Mitsubishi Motor Sales of Caribbean, Inc.
Customer Service Department
P.O. Box 192216
SAN JUAN PR 00919-2216

[For vehicles sold in Guam]

To contact Triple J Enterprises Inc.
call (671) 649-3673 or write to:
Triple J Enterprises, Inc.
P.O. Box 6066
TAMUNING
GUAM 96931

[For vehicles sold in Saipan]

To contact Triple J Motors
call (670) 234-7133 or write to:
Triple J Motors
P.O. Box 500487
SAIPAN, MP96950-0487

[For vehicles sold in American Samoa]

To contact Pacific Marketing Inc.
call 684 (699) 9140 or write to:
Pacific Marketing, Inc.
P.O. Box 698
PAGO PAGO,
AMERICAN SAMOA AS, 96799

4

Warning labels

N00408600338

Occupant restraint warning labels for the SRS are located in the vehicle as shown in the illustration.

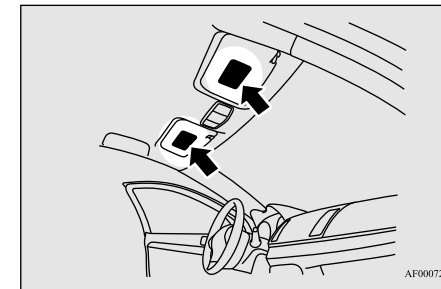

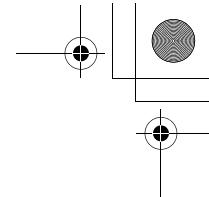

Supplemental Restraint System (SRS) - airbag

4

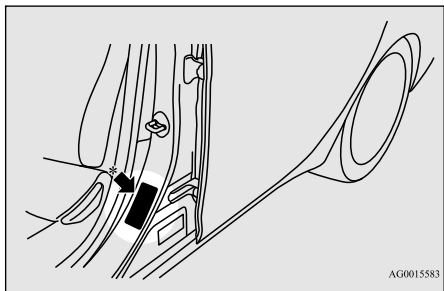

AG0015583

*- Located in the passenger's side as well.

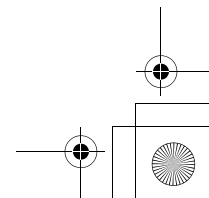
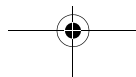
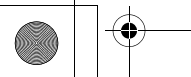
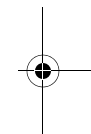
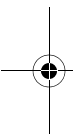

Features and controls

Break-in recommendations	5-3	Cruise control	5-72
Keys	5-3	Tire pressure monitoring system	5-76
Electronic immobilizer (Anti-theft starting system)	5-4	Rear-view camera (if so equipped).....	5-80
Keyless entry system (if so equipped).....	5-7	Instrument cluster	5-82
Free-hand Advanced Security Transmitter (F.A.S.T.-key) (if so equipped)	5-12	Multi-information display	5-84
Door locks	5-34	Indicator light, warning light, and information screen display list	5-104
Power door locks	5-37	Indicators	5-116
“Child safety locks” for rear door	5-38	Warning lights	5-117
Rear hatch	5-38	Information screen display	5-118
Inside rear hatch release	5-40	Combination headlights and dimmer switch	5-120
Theft-alarm system	5-40	Turn signal lever	5-124
Power windows	5-43	Hazard warning flasher switch	5-124
Sunroof (if so equipped)	5-45	Front fog light switch (if so equipped).....	5-125
Parking brake	5-48	Wiper and washer switch	5-125
Steering wheel tilt lock lever	5-49	Electric rear window defogger switch	5-128
Inside day/night rearview mirror	5-49	Horn switch	5-129
Outside rearview mirrors	5-50	Link System (if so equipped)	5-129
Ignition switch	5-52	Bluetooth® 2.0 interface (if so equipped).....	5-129
Steering wheel lock	5-53	USB input terminal	5-151
Starting and stopping the engine	5-54	Sun visors	5-154
Manual transaxle (if so equipped)	5-56	12 V power outlet	5-155
Continuously variable transmission (CVT) (if so equipped).....	5-58	Interior lights	5-156
Service brake	5-65	Storage spaces	5-158
Brake assist system	5-66	Cup holder	5-160
Anti-lock braking system	5-66	Bottle holder	5-161
Electric power steering system (EPS)	5-69	Rear shelf panel	5-161
Active stability control (ASC)	5-69	Dual height adjustable cargo floor board	5-162

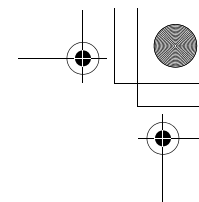
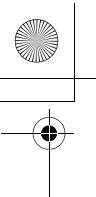

Features and controls

5

Assist grip	5-163
Coat hook	5-163

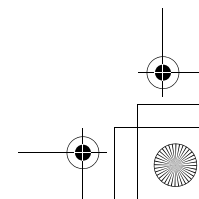
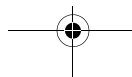
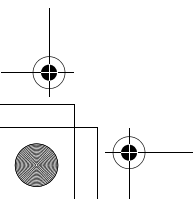
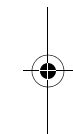
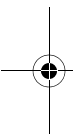

Break-in recommendations

N00508700314

Advanced automobile manufacturing techniques permit you to operate your new vehicle without requiring a long break-in period of low-speed driving.

However, you can add to the future performance and economy of your vehicle by observing the following precautions during the first 300 miles (500 km).

Drive your vehicle at moderate speeds during the break-in period.

- Avoid revving the engine. For vehicles equipped with turbocharger, do not exceed 5,000 rpm for the first 600 miles (1,000 km).
- Avoid rough driving such as fast starts, sudden acceleration, prolonged high-speed driving and sudden braking. These would have a detrimental effect on the engine and also cause increased fuel and oil consumption, which could result in malfunction of the engine components. Be particularly careful to avoid full acceleration while in low gear.
- Do not overload the vehicle. Observe the seating capacity (See “Cargo load precautions” on page 6-10).
- Do not use this vehicle for trailer towing.

Keys

N00508801644

Type 1

Two keys are provided. The keys fit all locks. Keep one in a safe place as a spare key.

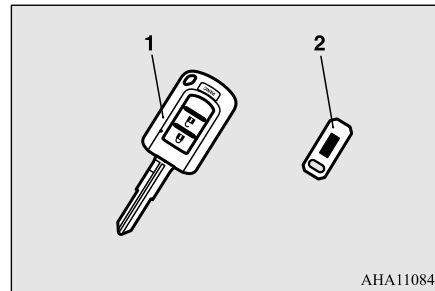

AHA110842

- 1- Key for the electronic immobilizer and keyless entry system
- 2- Key number plate

Type 2

Two Free-hand Advanced Security Transmitter (F.A.S.T.-key) and two emergency keys are provided.

Break-in recommendations

Keep one F.A.S.T.-key and one emergency key in a safe place together as a set of spare keys.

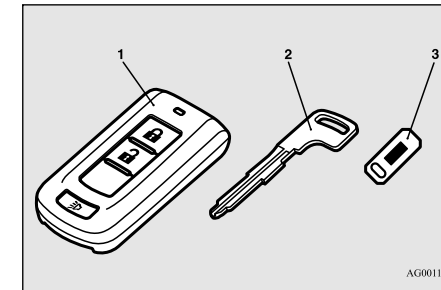

AG0011471

- 1- Free-hand Advanced Security Transmitter (F.A.S.T.-key) (with electronic immobilizer and keyless entry system function)
- 2- Emergency key
- 3- Key number plate

5

NOTE

- The key is a precision electronic device with a built-in signal transmitter. Please observe the following in order to prevent damage.
 - Do not leave where it may be exposed to heat caused by direct sunlight, such as on top of the dashboard.
 - Do not take the remote control transmitter apart.

Electronic immobilizer (Anti-theft starting system)

5

NOTE

- Do not excessively bend the key or subject it to strong impacts.
- Keep the remote control transmitter dry.
- Keep away from magnetic objects such as key rings.
- Keep away from devices that produce magnetism, such as audio systems, computers and televisions.
- Keep away from devices that emit strong electromagnetic waves, such as cellular phones, wireless devices and high frequency equipment (including medical devices.)
- Do not clean with ultrasonic cleaners.
- Do not leave the key where it may be exposed to high temperature or high humidity.
- If you lose your key, to prevent the theft of the vehicle immediately contact an authorized Mitsubishi Motors dealer. If you notify an authorized Mitsubishi Motors dealer of the key number, they can make a new key. The key number is stamped on the key number plate. Keep the key number plate in a safe place separate from the key itself.

NOTE

- No keys other than those registered in advance can be used to start the engine. Refer to “Electronic immobilizer (Anti-theft starting system)” on page 5-4. Refer to “Free-hand Advanced Security Transmitter (F.A.S.T.-key): Electronic immobilizer (Anti-theft starting system)” on page 5-27.
- When the theft-alarm is in the system operational status, the alarm operates if a door or rear hatch is opened after using the key, the door lock knob or the power door lock to unlock the vehicle.
- The system does not enter the preparation status if the keyless entry system or the F.A.S.T.-key was not used to lock the vehicle.

Electronic immobilizer (Anti-theft starting system)

N00509101817

[For vehicles equipped with the Free-hand Advanced Security Transmitter (F.A.S.T.-key)]

For information on operations for vehicles equipped with the Free-hand Advanced Security Transmitter (F.A.S.T.-key), refer to “Free-hand Advanced Security Transmitter (F.A.S.T.-key): Electronic immobilizer (Anti-theft starting system)” on page 5-27.

[Except for vehicles equipped with the Free-hand Advanced Security Transmitter (F.A.S.T.-key)]

The electronic immobilizer is designed to significantly reduce the possibility of vehicle theft. The purpose of the system is to immobilize the vehicle if an invalid start is attempted. A valid start attempt can only be achieved (subject to certain conditions) using a key “registered” to the immobilizer system. All of the keys provided with your new vehicle have been programmed to the vehicle’s electronics.

NOTE

- Do not attach additional keys or accessories to the ignition key. Such objects could prevent the driver’s knee airbag from inflating normally. Refer to “Deployment of front airbags” on page 4-29.
- In the following cases, the vehicle may not be able to recognize the registered ID code from the key. This means the engine will not start even when the key is turned to the “START” position.
 - When the key contacts a key ring or other metallic or magnetic object (Type A)
 - When the key grip contacts metal of another key (Type B)
 - When the key contacts or is close to other immobilizer keys (including keys of other vehicles) (Type C)

Electronic immobilizer (Anti-theft starting system)

NOTE

- In cases like the above, move the offending object(s) away from the key and turn the key back to the "ACC" or "LOCK" position. Then try to start the engine again. If the engine does not start, contact an authorized Mitsubishi Motors dealer.

A

AGZ000345

B

AGZ000576

C

AGZ000361

NOTE

- The key may not operate properly when it is near an object or facility that emits strong electromagnetic waves.
- Electronic immobilizer is not compatible with commercially available remote starting systems. Use of commercially available remote starting systems may result in vehicle starting problems and a loss of security protection.
- A system failure is suspected when the ignition switch is turned to the "START" position, and the engine does not start. In such a case, contact an authorized Mitsubishi Motors dealer.

WARNING

- Do not make any alterations or additions to the immobilizer system. Alterations or additions could cause failure of the immobilizer.

Replacement keys

Only keys that have been programmed to the vehicle's electronics can be used to start the vehicle.

If you lose the key, contact your authorized Mitsubishi Motors dealer by referring to the key number.

To prevent vehicle theft, the ID code for the vehicle keys must be changed.

Take your vehicle and all remaining keys to your authorized Mitsubishi Motors dealer to have your ID code changed.

Additional keys

5

To add a key, you need to register the ID code to the vehicle.

Registering the ID code can be done by your authorized Mitsubishi Motors dealer. Or it can be done by yourself (except for vehicles sold in Canada).

For you to register the ID code yourself, follow the "Customer key programming" procedure below.

If you choose to have your authorized Mitsubishi Motors dealer register the ID code, take your vehicle and all remaining keys to your authorized Mitsubishi Motors dealer.

NOTE

- You are provided with two keys, but you may register up to eight keys.

Electronic immobilizer (Anti-theft starting system)

Customer key programming (Except for vehicles sold in Canada)

N00562200067

5

You can program new keys to the system if you have two valid (already registered) keys and blank (not registered) immobilizer key (specially cut for your vehicle at your Mitsubishi Motors dealer) by doing the following:

1. Insert the first valid key into the ignition switch and turn the key to the "ON" position for 5 seconds.
2. Turn the key to the "LOCK" position and remove the first key.
3. Within 30 seconds of turning the first key to the "LOCK" position, insert the second valid key into the ignition and turn it to the "ON" position. About 10 seconds later, the immobilizer display will start to blink.

4. When the immobilizer display starts blinking, turn the second valid key to the "LOCK" position and remove it. Within 30 seconds after doing so, insert a blank immobilizer key into the ignition switch and turn it to the "ON" position. Perform this operation no more than 30 seconds after the immobilizer display starts blinking. When registration of the ID code is complete, the immobilizer display will come on for 3 seconds then go off. If an error occurs, the immobilizer display will go off during the procedure.



5. If you wish to register another key, perform the process again from step 1.

NOTE

- Perform the operation when the interrupt display screen is not showing. The interrupt display screen may prevent you from seeing the immobilizer display.
- It is not possible to register a key if:
 - the immobilizer display goes off during the procedure
 - the immobilizer display does not come on within 30 seconds after turning the ignition switch to the "ON" position with a blank immobilizer key

NOTE

- The procedure will be terminated automatically if:
 - a period of 30 seconds or longer elapses from the moment when the first key is turned to the "LOCK" position to the moment when the second key is turned to the "ON" position
 - a period of 30 seconds or longer elapses from the moment when the second key is turned to the "LOCK" position to the moment when the blank immobilizer key is turned to the "ON" position
- To use the new remote control transmitters, it is necessary to register the key with both the electronic immobilizer and keyless entry system.
Also refer to "Keyless entry system: Customer remote control transmitter programming" on page 5-9.

General information

N00562301108

Your electronic immobilizer operates on a radio frequency subject to Federal Communications Commission (FCC) Rules (For vehicles sold in U.S.A.) and Industry Canada Rules (For vehicles sold in Canada). This device complies with Part 15 of FCC Rules and Industry Canada licence-exempt RSS standard(s).

Operation is subject to the following two conditions.

- This device may not cause harmful interference.
- This device must accept any interference received, including interference that may cause undesired operation.

CAUTION

- Changes or modifications not expressly approved by the manufacturer for compliance could void the user's authority to operate the equipment.

Keyless entry system (if so equipped)

N00509001962

Press the remote control transmitter buttons to lock or unlock the doors and the rear hatch. It can also help you signal for attention by setting off the panic alarm.

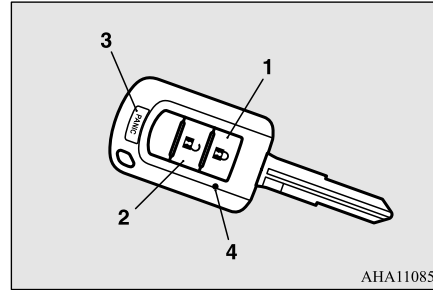

AHA110855

- 1- LOCK (🔒) button
- 2- UNLOCK (🔓) button
- 3- PANIC button
- 4- Indicator light

To lock

N00542700037

Press the LOCK button (1) to lock all the doors and the rear hatch. The turn signal lights will also blink once.

NOTE

- If you press the LOCK button (1) twice quickly, the horn will sound once.

Keyless entry system (if so equipped)

To unlock

N00543301112

Press the UNLOCK button (2) to unlock the driver's door only. Within about 2 seconds, press the UNLOCK button one more time to unlock all the doors and the rear hatch. The dome light will turn on for 30 seconds. The turn signal lights will also blink twice. The front side-marker and parking lights will also turn on for about 30 seconds. Refer to "Welcome light" on page 5-123.

5

NOTE

- The door and rear hatch unlock function can be set so that all doors and the rear hatch unlock when the UNLOCK button (2) is pressed once. Refer to "Setting of door and rear hatch unlock function" on page 5-8.

Answerback function

N00543501101

Setting of the horn and turn signal lights of the keyless entry system answerback function can be changed as required. This is done with the key removed from the ignition switch.

Keyless entry system (if so equipped)

NOTE

- The answerback function does not operate when the key is in the ignition switch or any doors or rear hatch is opened.

5

Horn deactivation/reactivation

The horn answerback function can be set to the following three conditions. Each time the horn answerback function is set, a chime will sound to tell you the condition of the answerback function.

Number of chimes	Condition
One chime	The horn will not sound.
Two chimes	The horn will sound.
Four chimes	The horn will sound if the LOCK button (1) is pressed twice quickly.

1. Remove the key from the ignition switch.
2. Open the driver's door and turn the combination headlights and dimmer switch to the "OFF" position.
3. Press the LOCK button (1) for 4 to 10 seconds and press the UNLOCK button (2) during this time.

4. Release in sequence the UNLOCK and LOCK buttons within 10 seconds of pressing the UNLOCK button in step 3.

Changing the setting of the turn signal lights answerback function

The turn signal lights answerback function can be set to the following seven conditions. Each time the turn signal lights answerback function is set, a chime will sound to tell you the condition of the answerback function.

Number of chimes	Condition	
	To lock	To unlock
One chime	One flash	Two flashes
Two chimes	One flash	No flash
Three chimes	No flash	Two flashes
Four chimes	Two flashes	One flash
Five chimes	No flash	One flash
Six chimes	Two flashes	No flash
Seven chimes	No flash	No flash

1. Remove the key from the ignition switch.
2. Open the driver's door and turn the combination headlights and dimmer switch to the "OFF" position.

3. Press the UNLOCK button (2) for 4 to 10 seconds and press the LOCK button (1) during this time.
4. Release in sequence the UNLOCK and LOCK buttons within 10 seconds of pressing the LOCK button in step 3.

Setting of door and rear hatch unlock function

N00543601144

The door and rear hatch unlock function can be set to the following two conditions. Each time the door and rear hatch unlock function is set, a chime will sound to tell you the condition of the door and rear hatch unlock function.

Number of chimes	Condition
One chime	All doors and rear hatch unlock
Two chimes	Driver's door unlock only

1. Remove the key from the ignition switch.
2. Open the driver's door and turn the combination headlights and dimmer switch to the "OFF" position.
3. Press the LOCK button (1) for 4 to 10 seconds and press the UNLOCK button (2) during this time.

4. Release in sequence the LOCK and UNLOCK buttons within 10 seconds of pressing the LOCK button in step 3.

Using the panic alarm

N00543700021

If you are near your vehicle and feel threatened, you may activate the alarm to call attention as follows:

1. Press the PANIC button (3) for more than 1 second.
2. The headlights will blink on and off and the horn will sound intermittently for about 3 minutes.
3. To turn off the alarm, press any button on the remote control transmitter.

Replacement remote control transmitters

N00543800035

Only remote control transmitters programmed with the vehicle's electronics can lock or unlock all doors and the rear hatch.

If you lose the remote control transmitter, you can order a remote control transmitter from your authorized Mitsubishi Motors dealer by referring to the key number.

To prevent vehicle theft, the ID codes for all the remote control transmitters except the one for the lost key must be programmed again. Take your vehicle and all the remaining remote control transmitters to your authorized Mitsubishi Motors dealer to have your ID codes programmed again.

Additional remote control transmitters

N00543900036

To add a remote control transmitter, you must already have one registered remote control transmitter.

Registering the ID code can be done by yourself or by your authorized Mitsubishi Motors dealer. For you to register the ID code yourself, follow the "Customer remote control transmitter programming" procedure below. If you choose to have your authorized Mitsubishi Motors dealer register the ID code, take your vehicle and all remaining keys to your authorized Mitsubishi Motors dealer.

NOTE

- You are provided with two remote control transmitters, but you may register up to eight remote control transmitters.

Keyless entry system (if so equipped)

Customer remote control transmitter programming (Except for vehicles sold in Canada)

N00544001161

You can program new remote control transmitters to the system if you have one valid (already registered) remote control transmitter by doing the following:

5

1. Have available all (current and new) remote control transmitters you wish to register.
2. With a valid (already registered) remote control transmitter, press the UNLOCK button (2) for 4 to 10 seconds. Then press and hold the LOCK button (1).
3. Within 10 seconds of pressing the LOCK button, release the LOCK and UNLOCK buttons in sequence.
At this time, ID codes for all remote control transmitters except for the transmitter used in steps 2 and 3 are erased and the answerback function (door or rear hatch is locked and unlocked) informs you that the registration mode has been activated.
4. Within 60 seconds after step 3, complete the following ID code registration operation using the next remote control transmitter you wish to register within 4 seconds.

Keyless entry system (if so equipped)

- i. Press both the LOCK and UNLOCK buttons for 2 seconds.
- ii. Release both the LOCK and UNLOCK buttons for 1 second.
- iii. Press the UNLOCK button.

The answerback function informs you that the ID code registration of the transmitter is completed.

5

5. To register the ID codes of additional remote control transmitters, repeat step 4 within 60 seconds after step 4.
6. If no ID code of a remote control transmitter is registered within 60 seconds after step 4, the registration mode is canceled and the normal mode returns.

NOTE

- For verification purposes, try to lock and unlock the doors and the rear hatch after the registration is completed.
- The indicator light (4) comes on each time a button is pressed.
- The keyless entry system does not work if the key is in the ignition switch.
- The remote control transmitter can be used from about 40 feet (12 m) away. However, this distance may change if your vehicle is near a TV transmitting tower, a power station, or a radio station.

NOTE

- If the UNLOCK button (2) is pressed when all doors and the rear hatch are locked and no doors or the rear hatch are opened within about 30 seconds, the doors and the rear hatch will automatically re-lock.
- If the following conditions are observed after pressing the buttons on the remote control transmitter, the battery in the remote control transmitter may need to be replaced.
 - The doors and the rear hatch cannot be locked or unlocked.
 - The panic alarm cannot be operated.
 - The indicator light (4) is dim or does not come on.
- If you lose your remote control transmitter, please contact an authorized Mitsubishi Motors dealer for a replacement.
- If you wish to obtain an additional remote control transmitter, please contact an authorized Mitsubishi Motors dealer. A maximum of eight remote control transmitters can be programmed for your vehicle.
- To use the new remote control transmitters, it is necessary to register the key with both the electronic immobilizer and keyless entry system. Also refer to “Electronic immobilizer (Anti-theft starting system): Customer key programming” on page 5-6.

General information

N00546101111

Your keyless entry system operates on a radio frequency subject to Federal Communications Commission (FCC) Rules (For vehicles sold in U.S.A.) and Industry Canada Rules (For vehicles sold in Canada). This device complies with Part 15 of FCC Rules and Industry Canada licence-exempt RSS standard(s).

Operation is subject to the following two conditions.

- This device may not cause harmful interference.
- This device must accept any interference received, including interference that may cause undesired operation.

CAUTION

- Changes or modifications not expressly approved by the manufacturer for compliance could void the user's authority to operate the equipment.

Procedure for replacing the remote control transmitter battery

N00544101146

1. Before replacing the battery, remove static electricity from your body by touching a metal grounded object.
2. Remove the screw (A) from the remote control transmitter.

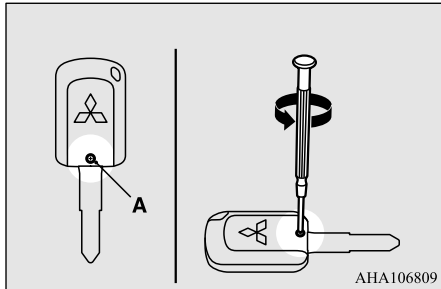

3. With the Mitsubishi mark facing you, insert the cloth-covered tip of a flat blade screwdriver into the notch in the remote control transmitter case and use it to open the case.

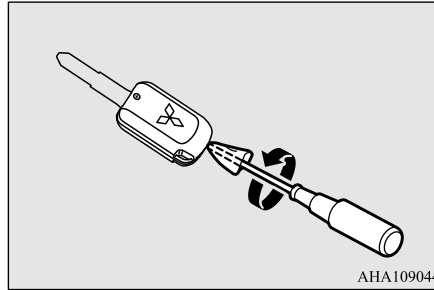

NOTE

- Be sure to perform the procedure with the Mitsubishi mark facing you. If the Mitsubishi mark is not facing you when you open the remote control transmitter case, the buttons may come out.
- The Federal Communications Commission (FCC) ID number, the Industry Canada (IC) number and the model number (radio certification) are indicated in the illustrated position.

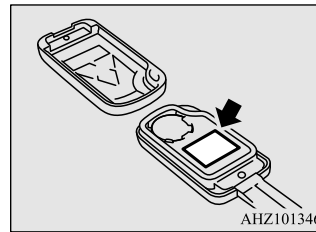

4. Remove the old battery.

Keyless entry system (if so equipped)

5. Install a new battery with the +side (B) up.

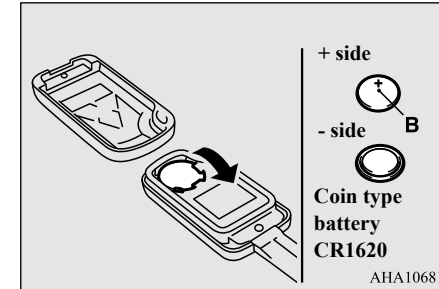

5

6. Close the remote control transmitter case firmly.
7. Attach the screw (A) removed in step 2.
8. Check the keyless entry system to see that it works.

NOTE

- You may purchase a replacement battery at an electric appliance store.
- Your authorized Mitsubishi Motors dealer can replace the battery for you if you prefer.

CAUTION

- When the remote control transmitter case is opened, be careful to keep water, dust, etc. out. Also, do not touch the internal components.

Free-hand Advanced Security Transmitter (F.A.S.T.-key) (if so equipped)

Free-hand Advanced Security Transmitter (F.A.S.T.-key) (if so equipped)

N00503100081

5

The Free-hand Advanced Security Transmitter (F.A.S.T.-key) enables the doors and the rear hatch to be locked and unlocked and the engine to be started simply by carrying it. The F.A.S.T.-key can also be used as the remote control transmitter of the keyless entry system.

Refer to “Free-hand Advanced Security Transmitter (F.A.S.T.-key): Keyless entry system” on page 5-30.

The F.A.S.T.-key must be carried by the driver. The F.A.S.T.-key is required for vehicle operations such as locking and unlocking the doors and the rear hatch, and starting the engine. When leaving the vehicle, make sure you are carrying the F.A.S.T.-key and then lock the vehicle.

WARNING

- Individuals who use implantable pacemakers or implantable cardioverter-defibrillators should keep away from the external and internal transmitters. The electromagnetic waves used in the F.A.S.T.-key may affect the operation of implantable pacemakers and implantable cardioverter-defibrillators.

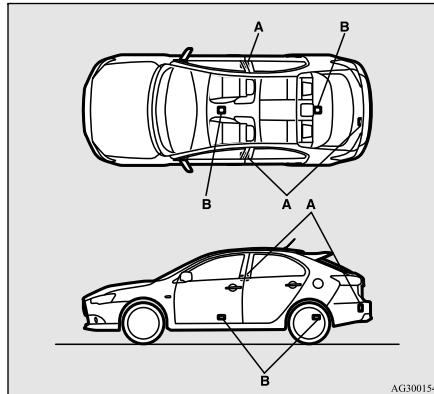

A- External transmitter
B- Internal transmitter

WARNING

- Individuals using other electrical medical apparatuses besides implantable pacemakers and implantable cardioverter-defibrillators should check with the manufacturer of the apparatus to confirm the effect of the electromagnetic waves used by the F.A.S.T.-key. The electromagnetic waves may affect the operations of the electro-medical apparatus.

The operations possible with the F.A.S.T.-key can be modified as stated below. (Keyless entry operations are possible.) For details, contact an authorized Mitsubishi Motors dealer.

- Enabling only the locking and unlocking of the doors and the rear hatch
- Enabling only the starting of the engine
- Deactivating the F.A.S.T.-key

NOTE

- The F.A.S.T.-key uses weak electromagnetic waves. In cases such as the following, operation may be improper or unstable.
 - The vehicle is near a facility that emits strong electromagnetic waves, such as a TV transmitting tower, a power station, a radio station or an airport

Free-hand Advanced Security Transmitter (F.A.S.T.-key) (if so equipped)

NOTE

- The key is carried together with other communication devices such as cellular phones or radios, or electrical appliances such as computers
- The F.A.S.T.-key touches or is covered by a metal object
- A keyless entry system is being used nearby
- The battery of the F.A.S.T.-key is run down
- The vehicle is in a location with strong electromagnetic waves or noise

Use the emergency key in such circumstances.

Refer to “To operate using the emergency key” on page 5-22.

- The F.A.S.T.-key is constantly performing reception operations in its communication with the vehicle. This means that the battery is always running down, regardless of how often the F.A.S.T.-key is used. The battery life is about 1 to 3 years, depending on the usage conditions.
- Since the F.A.S.T.-key is constantly performing reception operations, the reception of strong electromagnetic waves can accelerate the running down of the battery. Do not place near electrical appliances such as televisions or computers.

Operating range of the F.A.S.T.-key

N00503201180

When a person enters the operating range of the F.A.S.T.-key while carrying the F.A.S.T.-key and press the driver's or front passenger's door lock/unlock switch, the rear hatch LOCK switch or the rear hatch OPEN switch, verification of the ID code is performed.

The F.A.S.T.-key enables the doors and the rear hatch to be locked and unlocked and the engine to be started only when the ID codes of the vehicle and F.A.S.T.-key match.

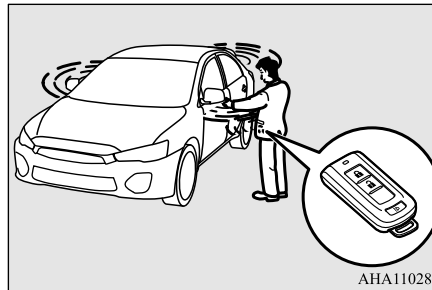

AHA110288

NOTE

- When the battery of the F.A.S.T.-key has run down or there are strong electromagnetic waves or noise in the area, the operating range could decrease or operations could become unstable.

Operating range for locking and unlocking the doors and the rear hatch

The operating range is within about 2.3 feet (70 cm) of the handles of the driver's and front passenger doors and the center of the rear hatch.

5

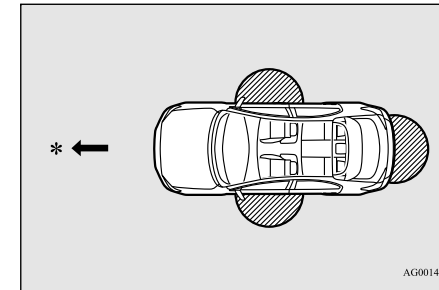

AG0014300

*: Front of the vehicle

: Operating range

NOTE

- Only the doors and the rear hatch that detect the F.A.S.T.-key can be locked and unlocked.
- The system may not operate if the F.A.S.T.-key is too close to the windshield, door windows or rear hatch.

Free-hand Advanced Security Transmitter (F.A.S.T.-key) (if so equipped)

5

NOTE

- Even if the F.A.S.T.-key is within about 2.3 feet (70 cm) of the handles of the driver's and front passenger doors and center of the rear hatch, the system may not operate if the key is close to the ground or in a high position.
- If the F.A.S.T.-key is within the operating range, even a person not carrying the F.A.S.T.-key can lock and unlock the doors or the rear hatch by pressing the driver's or front passenger's door lock/unlock switch, the rear hatch LOCK switch or the rear hatch OPEN switch.

Operating range for starting the engine

N00503300041

The operating range is the interior of the vehicle.

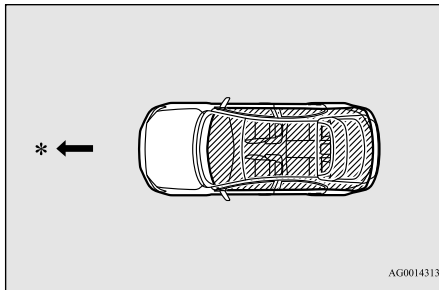

*: Front of the vehicle

5-14 Features and controls

: Operating range

NOTE

- Even if the F.A.S.T.-key is within the operating range, it may not be possible to start the engine if the key is in a storage space such as the glove compartment, on top of the instrument panel, or in the door pocket or luggage compartment.
- Even if the F.A.S.T.-key is outside the vehicle, it may be possible to start the engine if the key is too close to a door or door window.

To operate using the F.A.S.T.-key

N00503401267

To lock

While carrying the F.A.S.T.-key, press the driver's or front passenger's door lock/unlock switch (A), or the rear hatch LOCK switch (B) within the operating range to lock all the doors and rear hatch. The turn signal lights will blink once and the buzzer will sound once.

Also refer to "Door locks", "Power door locks" and "Rear hatch" on pages 5-34, 5-37 and 5-38 respectively.

Driver's and front passenger's door lock/unlock switches

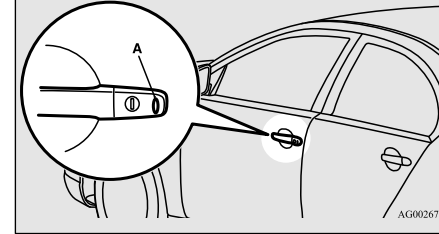

Rear hatch switches

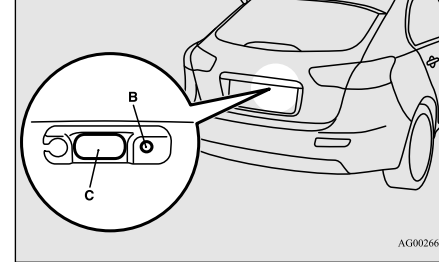

NOTE

- In cases such as the following, the F.A.S.T.-key does not operate.
 - A door or the rear hatch is open or ajar
 - The ignition switch is in a position other than "LOCK"
 - The emergency key is inserted into the ignition switch

Free-hand Advanced Security Transmitter (F.A.S.T.-key) (if so equipped)

NOTE

- The rear hatch OPEN switch (C) can be used to confirm that the vehicle is locked properly. Press the rear hatch OPEN switch within about 3 seconds of locking.
- If the rear hatch OPEN switch is pressed 3 seconds or more after the vehicle is locked, the doors and the rear hatch are unlocked.
- The time within which locking confirmation is possible can be adjusted. See an authorized Mitsubishi Motors dealer for details.

Driver's door lock/unlock switch

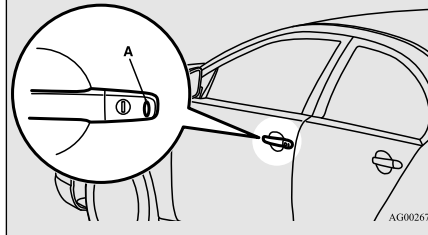

Front passenger's door lock/unlock switch

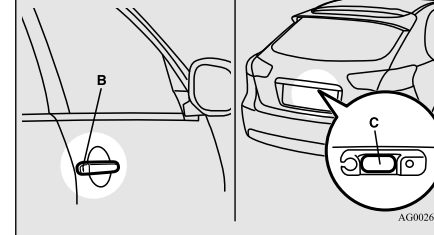

5

To unlock

While carrying the F.A.S.T.-key within the operating range, you can unlock the doors and the rear hatch by F.A.S.T.-key operation. The dome light will turn on for 30 seconds. The turn signal lights will blink twice and the buzzer will sound twice.

Also refer to “Door locks”, “Power door locks” and “Rear hatch” on pages 5-34, 5-37 and 5-38 respectively.

Press the driver's door lock/unlock switch (A) to unlock only the driver's door. Within about 2 seconds, press the driver's door lock/unlock switch (A) one more time to unlock all the doors and rear hatch.

NOTE

- Settings can be changed so that all doors and rear hatch are unlocked automatically by pressing the driver's door lock/unlock switch (A) once. Refer to “Setting of door and rear hatch unlock function” on page 5-31.

Press the front passenger's door lock/unlock switch (B), or the rear hatch OPEN switch (C) to unlock all the doors and the rear hatch.

NOTE

- If the doors and the rear hatch are unlocked when all doors and the rear hatch are locked and no doors or the rear hatch are opened within about 30 seconds, the doors and the rear hatch will automatically re-lock.
- The amount of time after unlocking until the vehicle re-locks automatically can be adjusted. See an authorized Mitsubishi Motors dealer for details.
- In cases such as the following, the F.A.S.T.-key does not operate.
 - A door or the rear hatch is open or ajar
 - The ignition switch is in a position other than “LOCK”
 - The emergency key is inserted into the ignition switch
- The doors and the rear hatch cannot be unlocked by using the rear hatch OPEN switch for about 3 seconds after locking.

Free-hand Advanced Security Transmitter (F.A.S.T.-key) (if so equipped)

NOTE

- The time within which locking confirmation is possible can be adjusted. See an authorized Mitsubishi Motors dealer for details.
- Function settings can be modified as stated below.
See an authorized Mitsubishi Motors dealer for details.
- Activating the operation confirmation function (flashing of the hazard warning lights) only during locking, or only during unlocking.
- Deactivating the operation confirmation function (flashing of the hazard warning lights) and buzzer.
- Modifying the number of flashes in the operation confirmation function (flashing of the hazard warning lights).
- Making the buzzer sound when the F.A.S.T.-key is removed from the passenger compartment when all the doors and the rear hatch are closed.

Ignition switch

N00513500059

To prevent vehicle theft, no F.A.S.T.-keys other than those registered in advance can be used to start the engine. (Electronic immobilizer function)
While carrying the F.A.S.T.-key, the ignition switch can be turned to start the engine.

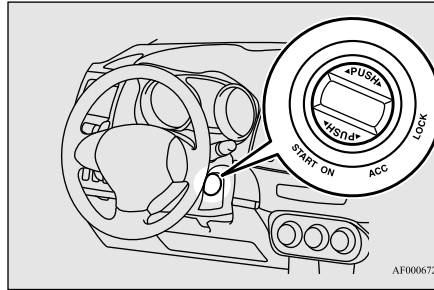

LOCK (PUSH OFF)

The position where the steering wheel is locked.

LOCK (PUSH ON)

When the ID code verification inside the vehicle produces a match, the ignition switch can be turned.

ACC

Allows operation of electrical accessories with the engine off.

ON

The engine runs and all electrical accessories can be used.

START

Engages the starter. Release the ignition switch when the engine starts. The ignition switch returns automatically to the "ON" position.

NOTE

- Your vehicle is equipped with an electronic immobilizer. To start the engine, the ID code which the F.A.S.T.-key sends must match the one registered to the immobilizer computer. (Refer to "Electronic immobilizer (Anti-theft starting system)" on page 5-27.)
- If the ignition switch is not turned to the "LOCK (PUSH OFF)" position when the engine is not running, the ID code cannot be verified and the engine will not start even if the ignition switch is turned to the "START" position. If this happens, fully return the ignition switch to the "LOCK (PUSH OFF)" position, and start the engine again.

Free-hand Advanced Security Transmitter (F.A.S.T.-key) (if so equipped)

To turn from “LOCK (PUSH OFF)” to “ACC”

N00513600021

Turn slowly after pressing the ignition switch.

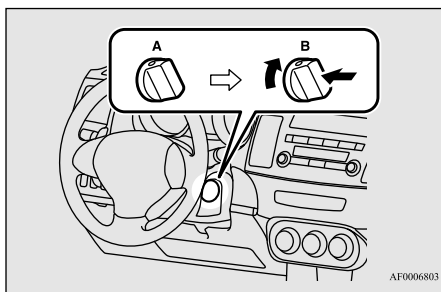

AF0006803

- A- Steering wheel locked
- B- Steering wheel lock released

NOTE

- To turn the ignition switch from the “LOCK (PUSH OFF)” position to the “ACC” position, push the ignition switch again, turn the steering wheel in both directions and then turn the ignition switch.
- The ignition switch cannot be turned unless the F.A.S.T.-key is inside the vehicle. Refer to “Operating range for starting the engine” on page 5-14.

To turn from “ACC” to “LOCK”

N00513701104

For vehicles equipped with manual transaxle

Slowly turn the ignition switch to the “LOCK” position while pressing it.

For vehicles equipped with continuously variable transmission (CVT)

First, set the selector lever to the “P” (PARK) position, and then slowly turn the ignition switch to the “LOCK” position while pressing it.

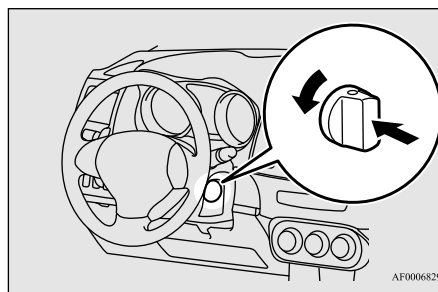

AF0006829

NOTE

- For vehicles equipped with CVT, the ignition switch cannot be turned to the “LOCK” position unless the selector lever is in the “P” (PARK) position.

CAUTION

- If the engine is stopped while driving, the power brake booster will stop functioning and greater effort for braking will be required. Also, the power steering system will not function and it will require greater effort to manually steer the vehicle.
- Do not leave the ignition switch in the “ON” or “ACC” position for a long time when the engine is not running. Doing so could lead to a dead battery.
- Do not turn the ignition switch to the “START” position when the engine is running. It will damage the starter motor.

5

Warning activation

N00503500203



With the F.A.S.T.-key, warnings are given through buzzers and displays on the information screen in the multi-information display in order to prevent mistaken operations or vehicle theft.

When a warning operates, be sure to check the vehicle and the F.A.S.T.-key. A warning is

Free-hand Advanced Security Transmitter (F.A.S.T.-key) (if so equipped)



also displayed if there is a problem in the F.A.S.T.-key.
If the following warning displays, contact an authorized Mitsubishi Motors dealer.





5

Type 1 	There is a problem in the F.A.S.T.-key
Type 2 	



If the following warning display, the display goes off if corrective action is taken.





- The ID codes of the F.A.S.T.-key and the vehicle cannot be verified

Type 1 	Someone may be carrying a F.A.S.T.-key with a different ID code, or the F.A.S.T.-key may not be within the operating range
Type 2 	

Type 1 	Refer to “F.A.S.T.-key take-out monitoring system” on page 5-18.
Type 2 	
Type 1 	The battery of the F.A.S.T.-key is run down
Type 2 	

- A door or the rear hatch cannot be locked even when the driver’s or front passenger’s door lock/unlock switch or the rear hatch LOCK switch is pressed.

Type 1 	Refer to “Key lock-in prevention system” on page 5-19.
Type 2 	

Type 1 	Refer to “Door ajar prevention system” on page 5-19.
Type 2 	
Type 1 	Refer to “Ignition switch turn-off reminder system” on page 5-19.
Type 2 	

F.A.S.T.-key take-out monitoring system

N00559801170

Type 1 
Type 2 

Free-hand Advanced Security Transmitter (F.A.S.T.-key) (if so equipped)

When the ignition switch is in a position other than the “LOCK (PUSH OFF)”, if the door(s) are opened, the F.A.S.T. - key is removed from the passenger compartment, and then the door(s) are closed, the warning display is displayed and the buzzer sounds 4 times as a warning since it’s impossible to verify the ID codes of the F.A.S.T.-key and vehicle.

NOTE

- The F.A.S.T.-key take-out monitoring system does not function if the F.A.S.T.-key is removed through a window without opening a door. This setting can be changed. See an authorized Mitsubishi Motors dealer for details.
- The warning may display even if the F.A.S.T.-key is in the operating range for starting the engine. The surrounding environment or electromagnetic waves may make it impossible to verify the ID codes of the F.A.S.T.-key and vehicle.

Key lock-in prevention system

N00559900145

Type 1



Type 2



When the ignition switch is in the “LOCK (PUSH OFF)” position, the F.A.S.T.-key is left in the passenger compartment, all the doors and the rear hatch are closed, and someone tries to lock the vehicle by pressing the driver’s or front passenger’s door lock/unlock switch, or the rear hatch LOCK switch, the warning display is displayed and the buzzer sounds for about 3 seconds as a warning, and the doors and the rear hatch cannot be locked.

If all the doors and the rear hatch are manually locked and closed while the ignition switch is in the “LOCK (PUSH OFF)” position and the F.A.S.T.-key is left in the car, the doors and the rear hatch will automatically unlock and a buzzer will sound for about 3 seconds.

Door ajar prevention system

N00560000146

Type 1



Type 2



5

When the ignition switch is in the “LOCK (PUSH OFF)” position, and someone tries to lock the vehicle by pressing the driver’s or front passenger’s door lock/unlock switch, or the rear hatch LOCK switch while one of the doors or the rear hatch is not fully closed, the warning display is displayed and the buzzer sounds for about 3 seconds as a warning, and the doors and the rear hatch cannot be locked.

Ignition switch turn-off reminder system

N00560100147

Type 1



Free-hand Advanced Security Transmitter (F.A.S.T.-key) (if so equipped)

Type 2



5

When the ignition switch is in a position other than “LOCK (PUSH OFF)”, all the doors and the rear hatch are closed, and someone tries to lock the vehicle by pressing the driver’s or front passenger’s door lock/unlock switch, or the rear hatch LOCK switch, the warning display is displayed and the buzzer sounds for about 3 seconds as a warning, and the doors and the rear hatch cannot be locked.

Steering wheel lock

N00514300025

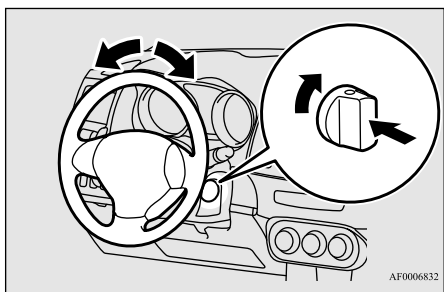

AF0006832

To lock

Turn the ignition switch to the “LOCK” position.

Turn the steering wheel until it is locked.

To unlock

Turn the ignition switch to the “ACC” position while moving the steering wheel slightly.

CAUTION

- Carry the key with you when leaving the vehicle.
- If your vehicle needs to be towed, turn the ignition switch to the “ACC” position to unlock the steering wheel.

NOTE

- If the front wheels are turned, the anti-theft lock may sometimes make it difficult to turn the ignition switch from “LOCK” to “ACC” position. Firmly turn the steering wheel to the left or to the right as you turn the ignition switch.

Starting

N00514601373

Tips for starting

- Do not operate the starter motor continuously for longer than 15 seconds as this could run the battery down or damage the starter motor. If the engine does not start, turn the ignition switch back to the “LOCK” position, wait a few seconds, and then try again. Trying repeatedly with the engine or starter motor still turning will damage the starter mechanism.
- If the engine will not start because the battery is weak or discharged, refer to “Jump-starting the engine” on page 8-2 for instructions.
- The engine is warmed up enough for driving when the bar graph of engine coolant temperature display starts to move. A longer warm up period will only consume extra fuel.

WARNING

- Never run the engine in a closed or poorly ventilated area any longer than is needed to move your vehicle out of the area. Carbon monoxide gas, which is odorless and extremely poisonous, could build up and cause serious injury or death.

Free-hand Advanced Security Transmitter (F.A.S.T.-key) (if so equipped)

CAUTION

- Do not push-start the vehicle.
- Do not run the engine at high rpms or drive at high speeds until the engine has had a chance to warm up.
- Release the ignition switch as soon as the engine starts. Otherwise, the starter motor will be damaged.

Starting the engine

Your vehicle is equipped with an electronically controlled fuel injection system. This is a system that automatically controls fuel injection. There is no need to depress the accelerator pedal when starting the engine.

The starter motor should not be run for more than 15 seconds at a time.

To prevent battery drain, wait a few seconds between attempts to restart the engine.

1. Make sure all occupants are properly seated with seat belts fastened.
2. Make sure the parking brake is applied.
3. Press and hold the brake pedal down firmly with your right foot.
4. Press and hold the clutch pedal all the way down (manual transaxle).

NOTE

- For models equipped with a manual transaxle, the starter will not operate unless the clutch pedal is fully depressed (Clutch interlock). This is a safety feature.

5. On vehicles equipped with manual transaxle, place the gearshift lever in the “N” (Neutral) position.

On vehicles equipped with continuously variable transmission (CVT), make sure the selector lever is in the “P” (PARK) position.

NOTE

- On vehicles equipped with CVT, the starter will not operate unless the selector lever is in the “P” (PARK) or “N” (NEUTRAL) position. For safety reasons, start the engine in the “P” (PARK) position so that the wheels are locked.

6. While pushing the ignition switch from “LOCK” (PUSH OFF) to “LOCK” (PUSH ON), set the ignition switch to the “ON” position and confirm that all warning lights and warning displays are operating properly.

7. Without pressing the accelerator pedal, slowly turn the ignition switch to the “START” position to start the engine. Release the ignition switch when the engine starts.

NOTE

- Minor noises may be heard on engine start-up. These will disappear as the engine warms up.

5**When the engine is hard to start**

After several attempts, you may experience that the engine still does not start.

1. Make sure that all electric devices, such as lights, air conditioning blower and rear window defogger, are turned off.
2. While depressing the brake pedal on vehicles equipped with continuously variable transmission (CVT) or the clutch pedal on the vehicles equipped with manual transaxle, press the accelerator pedal halfway and hold it there, then crank the engine. Release the accelerator pedal, immediately after the engine starts.

Free-hand Advanced Security Transmitter (F.A.S.T.-key) (if so equipped)

3. If the engine still will not start, the engine could be flooded with too much gasoline. While depressing the brake pedal on vehicles equipped with CVT or the clutch pedal on the vehicles equipped with manual transaxle, push the accelerator pedal all the way down and hold it there, then crank the engine for 5 to 6 seconds. Return the ignition switch to the "LOCK" position and release the accelerator pedal. Wait a few seconds, and then crank the engine again for 5 to 6 seconds while depressing the brake pedal or the clutch pedal, but do not push the accelerator pedal. Release the ignition key if the engine starts. If the engine fails to start, repeat these procedures. If the engine still will not start, contact your local Mitsubishi Motors dealer or a repair facility of your choice for assistance.

5

Startability of continuously variable transmission (CVT) vehicles at extremely cold ambient temperature

When the ambient temperature is -4°F (-20°C) or lower, it may not be possible to start from a standstill even with the selector lever in the "D" (DRIVE) or "R" (REVERSE) position.

This phenomenon occurs because the transaxle has not warmed up sufficiently; it does

not indicate a problem. If this occurs, place the selector lever in the "P" (PARK) position and let the engine idle for at least 10 minutes. The transaxle will warm up, and you will be able to drive normally. Do not leave the vehicle during warm-up operation.

To operate using the emergency key

N00514800020

Emergency key

N00515200135

The emergency key is built into the F.A.S.T.-key.

When the F.A.S.T.-key cannot be used, such as when the battery of the F.A.S.T.-key or the vehicle has run down, the emergency key can be used to lock and unlock the driver's door and to start the engine.

To use the emergency key (1), unlock the lock knob (2) and remove it from the F.A.S.T.-key (3).

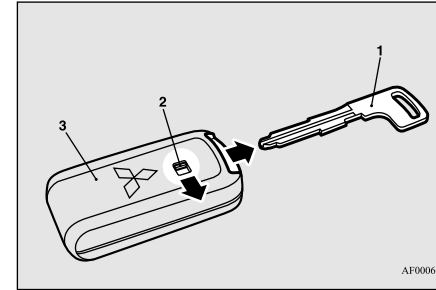

NOTE

- Only use the emergency key in an emergency. When the battery of the F.A.S.T.-key has run down, replace the battery as soon as possible and use it as a F.A.S.T.-key again.
- After using the emergency key, be sure to reinsert it into the F.A.S.T.-key.

To lock or unlock the driver's door with the emergency key

Turn the emergency key toward the front of the vehicle to lock the door. After checking that the door is locked, turn the emergency key back to the center and remove it.

Free-hand Advanced Security Transmitter (F.A.S.T.-key) (if so equipped)

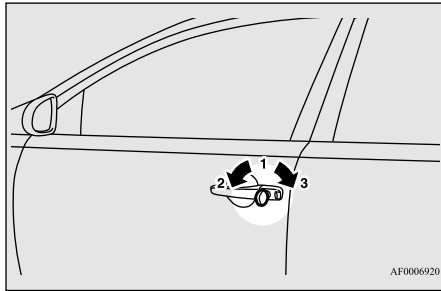

- 1- Insert or remove the emergency key
- 2- Lock
- 3- Unlock

Ignition switch

N00529301251

To prevent vehicle theft, only the emergency key with the pre-registered F.A.S.T.-key inserted can start the engine. (Electronic immobilizer function)

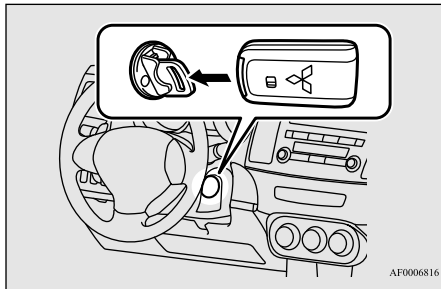

LOCK

The engine is off and the steering wheel is locked. The emergency key can be inserted and removed only when the ignition switch is in this position.

ACC

The electrical accessories can be used with the engine off.

ON

The engine will start only by using the emergency key with the F.A.S.T.-key inserted. It is possible to use all electrical accessories with only the emergency key.

START

Engages the starter. Release the emergency key when the engine starts. The ignition switch returns automatically to the "ON" position.

NOTE

- The vehicle is equipped with an electronic immobilizer. To start the engine, the ID code which the F.A.S.T.-key sends must match the one registered to the immobilizer computer. (Refer to "Electronic immobilizer (Anti-theft starting system)" on page 5-27.)

To turn from "LOCK" to "ACC"

1. Remove the emergency key from the F.A.S.T.-key.
Refer to "Emergency key" on page 5-22.
2. While pushing the lock release buttons (A), remove the cover of the ignition switch.

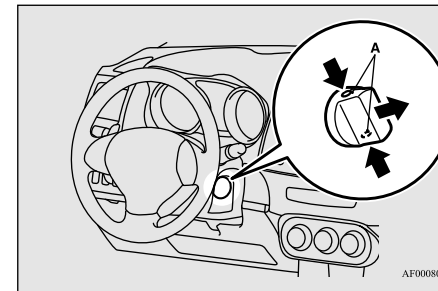

3. Insert the emergency key into the ignition switch, and slowly push and turn.

Free-hand Advanced Security Transmitter (F.A.S.T.-key) (if so equipped)

5

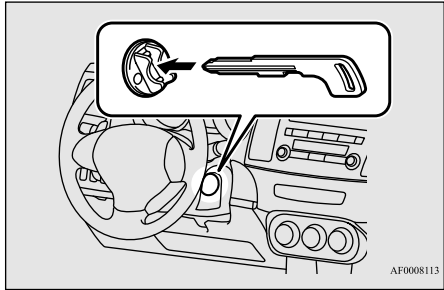

NOTE

- When the ignition switch cannot be turned from the “LOCK” position to the “ACC” position, turn the ignition switch while turning the steering wheel in both directions.

To turn from “ACC” to “LOCK”

1. [For vehicles equipped with manual trans-axle]

Push the emergency key in at the “ACC” position and keep it depressed until it is turned to the “LOCK” position, and remove.

[For vehicles equipped with continuously variable transmission (CVT)]

First, set the selector lever to the “P” (PARK) position, and then slowly turn the ignition switch to the “LOCK” position while pressing it.

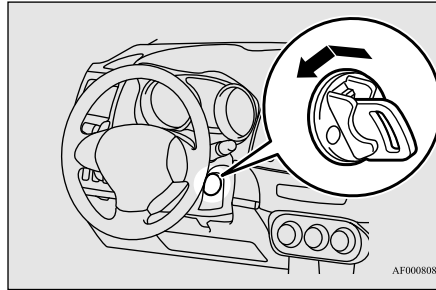

NOTE

- For vehicles equipped with CVT, the emergency key cannot be removed unless the selector lever is set to the “P” (PARK) position.

2. Install the cover of the ignition switch.
3. Reinsert the emergency key into the F.A.S.T.-key.

NOTE

- Always install the cover of the ignition switch when not using the emergency key. Not doing so could cause damage if foreign material such as dust gets into the keyhole of the ignition switch.

CAUTION

- Do not turn the ignition switch to the “LOCK” position while the vehicle is moving. This will cause the steering wheel to lock, making it impossible to operate the vehicle.
- If the engine is stopped while driving, the power brake booster will stop functioning and greater effort for braking will be required. Also, the power steering system will not function and it will require greater effort to manually steer the vehicle.
- Do not leave the ignition switch in the “ON” or “ACC” position for a long time when the engine is not running. The battery will run down.
- Do not turn the ignition switch to the “START” position when the engine is running. It will damage the starter motor.

Steering wheel lock

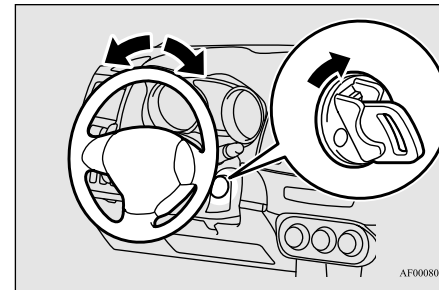

Free-hand Advanced Security Transmitter (F.A.S.T.-key) (if so equipped)

To lock

Turn the emergency key to the “LOCK” position.

Turn the steering wheel until it is locked.

To unlock

Turn the emergency key to the “ACC” position while moving the steering wheel slightly.

CAUTION

- Remove the emergency key when leaving the vehicle.
- If your vehicle needs to be towed, turn the emergency key to the “ACC” position to unlock the steering wheel.

NOTE

- If the front wheels are turned, the anti-theft lock may sometimes make it difficult to turn the emergency key from “LOCK” to “ACC”. Firmly turn the steering wheel to the left or to the right as you turn the emergency key.

Starting**Tips for starting**

- Do not operate the starter motor continuously for longer than 15 seconds as this could run the battery down or damage the starter motor. If the engine does not start, turn the emergency key back to the “LOCK” position, wait a few seconds, and then try again. Trying repeatedly with the engine or starter motor still turning will damage the starter mechanism.
- If the engine will not start because the battery is weak or discharged, refer to “Jump-starting the engine” on page 8-2 for instructions.
- The engine is warmed up enough for driving when the bar graph of engine coolant temperature display starts to move. A longer warm up period will only consume extra fuel.

WARNING

- **Never run the engine in a closed or poorly ventilated area any longer than is needed to move your vehicle out of the area. Carbon monoxide gas, which is odorless and extremely poisonous, could build up and cause serious injury or death.**

CAUTION

- Do not push-start the vehicle.

CAUTION

- Do not run the engine at high rpms or drive at high speeds until the engine has had a chance to warm up.
- Release the emergency key as soon as the engine starts. It will damage the starter motor.

Starting the engine

The vehicle is equipped with an electronically controlled fuel injection system. This is a system that automatically controls the fuel injection. There is no need to depress the accelerator pedal when starting the engine.

The starter motor should not be run for more than 15 seconds at a time.

To prevent battery drain, wait a few seconds between attempts to restart the engine.

1. Make sure all occupants are properly seated with seat belts fastened.
2. Make sure the parking brake is applied.
3. While pushing the lock release buttons (A), remove the cover of the ignition switch.

Free-hand Advanced Security Transmitter (F.A.S.T.-key) (if so equipped)

5

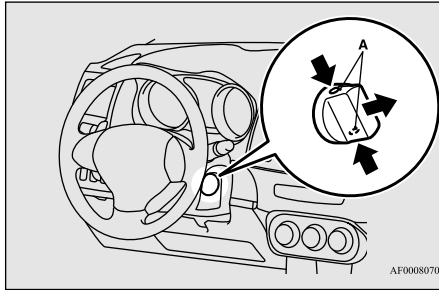

4. Insert the emergency key into the ignition switch.

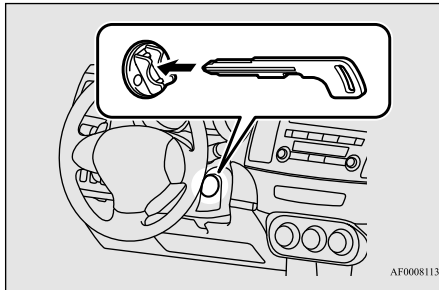

5. Insert the F.A.S.T.-key into the emergency key.

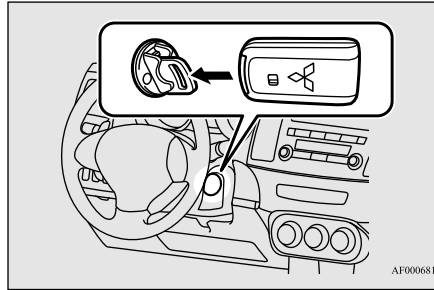

6. Press and hold the brake pedal down firmly with your right foot.

7. Press and hold the clutch pedal all the way down (manual transaxle).

NOTE

- On vehicles equipped with manual transaxle, the starter will not operate unless the clutch pedal is fully depressed (Clutch interlock). This is a safety feature.

8. On vehicles equipped with manual transaxle, place the gearshift lever in the “N” (Neutral) position.

On vehicles equipped with CVT, make sure the selector lever is in the “P” (PARK) position.

NOTE

- On vehicles equipped with CVT, the starter will not operate unless the selector lever is in the “P” (PARK) or “N” (NEUTRAL) position. For safety reasons, start the engine in the “P” (PARK) position so that the wheels are locked.

9. Turn the emergency key with the F.A.S.T.-key to the “ON” position and make certain that all warning lights and warning displays are functioning properly before starting the engine.

10. Turn the emergency key with the F.A.S.T.-key to the “START” position without pressing the accelerator pedal. Release the emergency key with the F.A.S.T.-key when the engine starts.

11. Remove the F.A.S.T.-key from the emergency key.

NOTE

- Minor noises may be heard on engine start-up. These will disappear as the engine warms up.

Free-hand Advanced Security Transmitter (F.A.S.T.-key) (if so equipped)

WARNING

- Make sure to remove the F.A.S.T.-key from the emergency key after the engine is started.

If not removed, the F.A.S.T.-key could fall to the floor, which may interfere with pedal operation.

Furthermore, the F.A.S.T.-key could prevent the driver's knee airbag from inflating normally or could be propelled to cause serious injury if the airbag inflates.

NOTE

- If the emergency key is attached to a key ring, it may become impossible to insert the F.A.S.T.-key into the emergency key, and it may prevent the engine from being started. When using the emergency key to start the engine, first remove the key from the key ring.

When the engine is hard to start

After several attempts, you may experience that the engine still does not start.

1. Make sure that all electric devices, such as lights, air conditioning blower and rear window defogger, are turned off.

2. While depressing the brake pedal on vehicles equipped with continuously variable transmission (CVT) or the clutch pedal on the vehicles equipped with manual transaxle, press the accelerator pedal halfway and hold it there, then crank the engine. Release the accelerator pedal, immediately after the engine starts.

3. If the engine still will not start, the engine could be flooded with too much gasoline. While depressing the brake pedal on vehicles equipped with CVT or the clutch pedal on the vehicles equipped with manual transaxle, push the accelerator pedal all the way down and hold it there, then crank the engine for 5 to 6 seconds. Return the ignition switch to the "LOCK" position and release the accelerator pedal. Wait a few seconds, and then crank the engine again for 5 to 6 seconds while depressing the brake pedal or the clutch pedal, but do not push the accelerator pedal. Release the ignition key if the engine starts. If the engine fails to start, repeat these procedures. If the engine still will not start, contact your local Mitsubishi Motors dealer or a repair facility of your choice for assistance.

Startability of continuously variable transmission (CVT) vehicles at extremely cold ambient temperature

When the ambient temperature is -4°F (-20°C) or lower or it may not be possible to start from a standstill even with the selector lever in the "D" (DRIVE) or "R" (REVERSE) position.

This phenomenon occurs because the transaxle has not warmed up sufficiently; it does not indicate a problem. If this occurs, place the selector lever in the "P" (PARK) position and let the engine idle for at least 10 minutes. The transaxle will warm up, and you will be able to drive normally.

Do not leave the vehicle during warm-up operation.

Electronic immobilizer (Anti-theft starting system)

N00529600127

The electronic immobilizer is designed to significantly reduce the possibility of vehicle theft. The purpose of the system is to immobilize the vehicle if an invalid start is attempted. A valid start attempt can only be achieved (subject to certain conditions) using a F.A.S.T.-key "registered" to the immobilizer system.

Free-hand Advanced Security Transmitter (F.A.S.T.-key) (if so equipped)

All of the keys provided with your new vehicle have been programmed to the vehicle's electronics.

Replacement F.A.S.T.-key

5

Only the F.A.S.T.-keys that have been programmed to the vehicle's electronics can be used to start the vehicle.

If you lose the F.A.S.T.-key, you can order a F.A.S.T.-key from your authorized Mitsubishi Motors dealer by referring to the key number. To prevent vehicle theft, the ID codes for all the F.A.S.T.-keys except the one for the lost F.A.S.T.-key must be programmed again.

Take your vehicle and all the remaining F.A.S.T.-keys to your authorized Mitsubishi Motors dealer to have your ID codes programmed again.

Additional F.A.S.T.-key

To add a F.A.S.T.-key, you must already have two registered F.A.S.T.-keys. You need to register the ID code to the vehicle. Registering the ID code can be done by your authorized Mitsubishi Motors dealer. Or it can be done by yourself (except for vehicles sold in Canada).

5-28 Features and controls

For you to register the ID code yourself, follow the "Customer F.A.S.T.-key programming" procedure below.

If you choose to have your authorized Mitsubishi Motors dealer register the ID code, take your vehicle and all remaining F.A.S.T.-keys to your authorized Mitsubishi Motors dealer.

NOTE

- You are provided with two F.A.S.T.-keys, but you may register up to four F.A.S.T.-keys. You can obtain blank F.A.S.T.-keys specially cut for your vehicle from your Mitsubishi Motors dealer.

Customer F.A.S.T.-key programming (Except for vehicles sold in Canada)

N00561200103

You can program new F.A.S.T.-keys to the system if you have two valid (already registered) F.A.S.T.-keys, blank (not registered) F.A.S.T.-key and emergency key (specially cut for your vehicle at your Mitsubishi Motors dealer).

To use the new F.A.S.T.-key, it is necessary to register the key with both the electronic immobilizer and keyless entry system.

Also refer to "Keyless entry system: Customer F.A.S.T.-key programming" on page

5-32.

For F.A.S.T.-key programming, follow the procedures below.

1. Remove the emergency key from the F.A.S.T.-key. Refer to "Emergency key" on page 5-22.
2. While pushing the lock release buttons (A), remove the cover of the ignition switch.

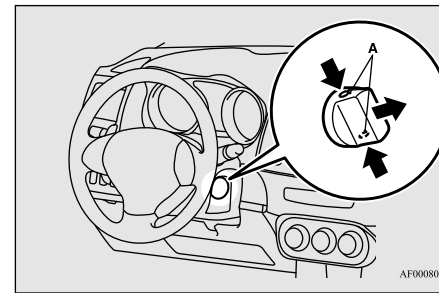

3. Insert the emergency key into the ignition switch.

Free-hand Advanced Security Transmitter (F.A.S.T.-key) (if so equipped)

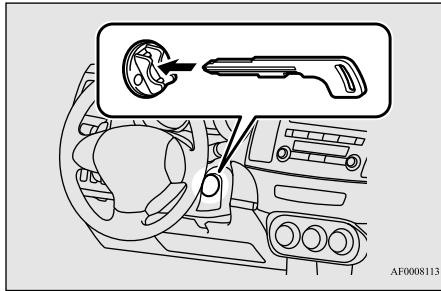

4. Insert the first valid F.A.S.T.-key into the emergency key.

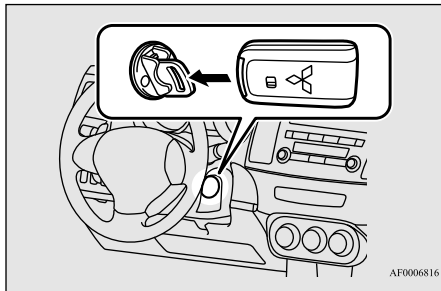

5. Turn the emergency key with the F.A.S.T.-key to the “ON” position for 5 seconds.

6. Turn the emergency key with the F.A.S.T.-key to the “LOCK” position. Within 30 seconds after doing so, remove the F.A.S.T.-key from the emergency key, insert the second valid F.A.S.T.-key into the emergency key and turn it to the “ON” position. About 10 seconds later, the immobilizer display will start to blink.
7. When the immobilizer display starts blinking, turn the second valid F.A.S.T.-key to the “LOCK” position and remove it. Within 30 seconds after doing so, insert a blank F.A.S.T.-key into the emergency key and turn it to the “ON” position. Perform this operation no more than 30 seconds after the immobilizer display starts blinking. When registration of the ID code is complete, the immobilizer display will come on for 3 seconds then go off. If an error occurs, the immobilizer display will go off during the procedure.



8. If you wish to register another F.A.S.T.-key, repeat the process from step 1.

NOTE

- Perform the operation when the interrupt display screen is not showing. The interrupt display screen may prevent you from seeing the immobilizer display.
- It is not possible to register a F.A.S.T.-key if:
 - the immobilizer display goes off during the procedure
 - the immobilizer display does not come on within 30 seconds after turning the ignition switch to the “ON” position with a blank F.A.S.T.-key
- The procedure will be terminated automatically if:
 - a period of 30 seconds or longer elapses from the moment when the first F.A.S.T.-key is turned to the “LOCK” position to the moment when the second F.A.S.T.-key is turned to the “ON” position
 - a period of 30 seconds or longer elapses from the moment when the second F.A.S.T.-key is turned to the “LOCK” position to the moment when the blank F.A.S.T.-key is turned to the “ON” position
- To use the new remote control transmitters, it is necessary to register the key with both the electronic immobilizer and keyless entry system.
Also refer to “Keyless entry system: Customer F.A.S.T.-key programming” on page 5-32.

5

Free-hand Advanced Security Transmitter (F.A.S.T.-key) (if so equipped)

Keyless entry system

N00515500196

Press the remote control transmitter buttons to lock or unlock the doors and the rear hatch. It can also help you signal for attention by setting off the panic alarm.

5

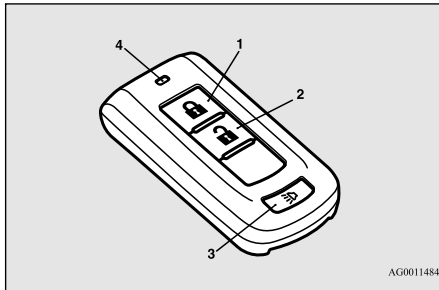

AG0011484

- 1- LOCK (🔒) button
- 2- UNLOCK (🔓) button
- 3- PANIC (🚨) button
- 4- Operation indicator light

To lock

N00544200049

Press the LOCK button (1) to lock all the doors and the rear hatch. The turn signal lights will also blink once.

NOTE

- If you press the LOCK button (1) twice quickly, the horn will sound once.

To unlock

N00544301122

Press the UNLOCK button (2) to unlock the driver's door only. Within about 2 seconds, press the UNLOCK button one more time to unlock all the doors and the rear hatch. The dome light will turn on for 30 seconds. The turn signal lights will also blink twice. The front side-marker and parking lights will also turn on for about 30 seconds. Refer to "Welcome light" on page 5-123.

NOTE

- The door and rear hatch unlock function can be set so that all doors and the rear hatch unlock when the UNLOCK button (2) is pressed once. Refer to "Setting of door and rear hatch unlock function" on page 5-31.

Answerback function

N00544501081

Setting of the horn, turn signal lights and buzzer of the keyless entry system answerback function can be changed as required.

This is done with the key removed from the ignition switch.

NOTE

- The answerback function does not operate when the key is in the ignition switch or any door or rear hatch is opened.

Horn deactivation/reactivation

The horn answerback function can be set to the following three conditions. Each time the horn answerback function is set, a chime will sound to tell you the condition of the answerback function.

Number of chimes	Condition
One chime	The horn will not sound.
Two chimes	The horn will sound.
Four chimes	The horn will sound if the LOCK button (1) is pressed twice quickly.

1. Turn the ignition switch to the "LOCK" position. If you started the engine with the key, remove the key from the ignition switch.
2. Open the driver's door and turn the combination headlights and dimmer switch to the "OFF" position.

Free-hand Advanced Security Transmitter (F.A.S.T.-key) (if so equipped)

3. Press the LOCK button (1) for 4 to 10 seconds and press the UNLOCK button (2) during this time.
4. Release in sequence the UNLOCK and LOCK buttons within 10 seconds of pressing the UNLOCK button in step 3.

Changing the setting of the turn signal lights answerback function

The turn signal lights answerback function can be set to the following seven conditions. Each time the turn signal lights answerback function is set, a chime will sound to tell you the condition of the answerback function.

Number of chimes	Condition	
	To lock	To unlock
One chime	One flash	Two flashes
Two chimes	One flash	No flash
Three chimes	No flash	Two flashes
Four chimes	Two flashes	One flash
Five chimes	No flash	One flash
Six chimes	Two flashes	No flash
Seven chimes	No flash	No flash

1. Turn the ignition switch to the “LOCK” position. If you started the engine with the key, remove the key from the ignition switch.

2. Open the driver’s door and turn the combination headlights and dimmer switch to the “OFF” position.
3. Press the UNLOCK button (2) for 4 to 10 seconds and press the LOCK button (1) during this time.
4. Release in sequence the UNLOCK and LOCK buttons within 10 seconds of pressing the LOCK button in step 3.

Buzzer deactivation/reactivation

The buzzer answerback function can be turned ON or OFF as required.

Setting of door and rear hatch unlock function

N00544601125

The door and rear hatch unlock function can be set to the following two conditions. Each time the door and rear hatch unlock function is set, a chime will sound to tell you the condition of the door and rear hatch unlock function.

Number of chimes	Condition
One chime	All doors and rear hatch unlock
Two chimes	Driver’s door unlock only

1. Turn the ignition switch to the “LOCK” position. If you started the engine with the key, remove the key from the ignition switch.
2. Open the driver’s door and turn the combination headlights and dimmer switch to the “OFF” position.
3. Press the LOCK button (1) for 4 to 10 seconds and press the UNLOCK button (2) during this time.
4. Release in sequence the LOCK and UNLOCK buttons within 10 seconds of pressing the LOCK button in step 3.

5

Using the panic alarm

N00544700028

If you are near your vehicle and feel threatened, you can activate the alarm to call attention as follows:

1. Press the PANIC button (3) for more than 1 second.
2. The headlights will blink on and off and the horn will sound intermittently for about 3 minutes.
3. To turn off the alarm, press any button on the remote control transmitter.

Free-hand Advanced Security Transmitter (F.A.S.T.-key) (if so equipped)

Replacement F.A.S.T.-keys

N00561300045

Only a F.A.S.T.-key, which has been programmed into the vehicle's electronics, can lock and unlock all the doors and the rear hatch, and start the engine.

5

If you lose the F.A.S.T.-key, you can order a F.A.S.T.-key from your authorized Mitsubishi Motors dealer by referring to the key number. To prevent vehicle theft, the ID codes for all the F.A.S.T.-keys except the one for the lost F.A.S.T.-key must be programmed again.

Take your vehicle and all the remaining F.A.S.T.-keys to your authorized Mitsubishi Motors dealer to have your ID codes programmed again.

Additional F.A.S.T.-keys

N00561400046

To add a F.A.S.T.-key, you must already have two registered F.A.S.T.-keys.

Registering the ID code can be done by your authorized Mitsubishi Motors dealer. Or it can be done by yourself (except for vehicles sold in Canada). For you to register the ID code yourself, follow the "Customer F.A.S.T.-key programming" procedure below. If you choose to have your authorized Mitsubishi Motors dealer register the ID code, take your vehicle and all remaining F.A.S.T.-

keys to your authorized Mitsubishi Motors dealer.

NOTE

- You are provided with two F.A.S.T.-keys, but you may register up to four F.A.S.T.-keys.

Customer F.A.S.T.-key programming (Except for vehicles sold in Canada)

N00561501132

You can program new F.A.S.T.-keys to the system if you have two valid (already registered) F.A.S.T.-keys, blank (not registered) F.A.S.T.-key and emergency key (specially cut for your vehicle at your Mitsubishi Motors dealer).

To use the new F.A.S.T.-key, it is necessary to register the key with both the electronic immobilizer and keyless entry system.

Also refer to "Electronic immobilizer: Customer F.A.S.T.-key programming" on page 5-28.

For F.A.S.T.-key programming, follow the procedures below.

1. Remove the emergency key from the F.A.S.T.-key. Refer to "Emergency key" on page 5-22.

2. While pushing the lock release buttons (A), remove the cover of the ignition switch.

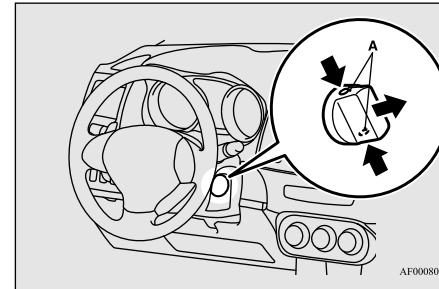

3. Insert the emergency key into the ignition switch.

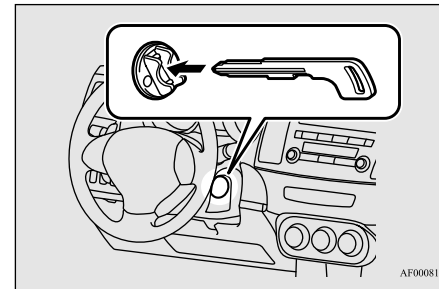

4. Insert the valid F.A.S.T.-key into the emergency key.

Free-hand Advanced Security Transmitter (F.A.S.T.-key) (if so equipped)

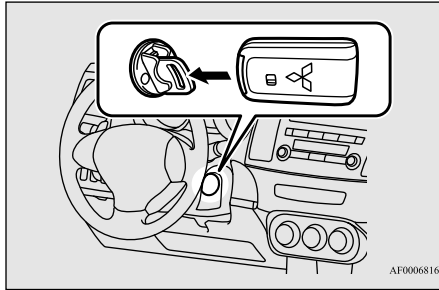

5. Turn the emergency key with F.A.S.T.-key to the "ON" position. (Perform the following procedure within 30 seconds)
6. Remove the F.A.S.T.-key from the emergency key.
7. With the first valid F.A.S.T.-key, press the UNLOCK button (2) and the LOCK button (1) simultaneously for 4 to 10 seconds.
8. Release in sequence the LOCK and UNLOCK buttons within 10 seconds of pressing the LOCK button in step 7. (Perform the following procedure within 30 seconds)
9. With the second valid F.A.S.T.-key, press the UNLOCK button for 4 to 10 seconds and press the LOCK button during this time.

10. Release in sequence the LOCK and UNLOCK buttons within 10 seconds of pressing the LOCK button in step 9, and the immobilizer display will blink on the information screen in the multi-information display. (Perform the following procedure within 60 seconds)
11. Press the LOCK button twice with the blank F.A.S.T.-key and the immobilizer display will come on for 30 seconds on the information screen in the multi-information display.
12. This completes the registration of the F.A.S.T.-key.

NOTE

- The indicator light (4) comes on each time a button is pressed.
- The keyless entry system does not work if the key is in the ignition switch.
- The F.A.S.T.-key can be used from about 40 feet (12 m) away. However, this distance may change if your vehicle is near a TV transmitting tower, a power station, or a radio station.
- If the UNLOCK button (2) is pressed when all doors and the rear hatch are locked and no doors or rear hatch are opened within about 30 seconds, the doors and the rear hatch will automatically re-lock.

NOTE

- If the following conditions are observed after pressing the buttons on the remote control transmitter, the battery in the remote control transmitter may need to be replaced.
 - The doors and the rear hatch cannot be locked or unlocked.
 - The panic alarm cannot be operated.
 - The indicator light (4) is dim or does not come on.
- If you lose your F.A.S.T.-key, please contact an authorized Mitsubishi Motors dealer for a replacement.
- If you wish to obtain an additional F.A.S.T.-key, please contact an authorized Mitsubishi Motors dealer. A maximum of four F.A.S.T.-key can be programmed for your vehicle.
- To use the new remote control transmitters, it is necessary to register the key with both the electronic immobilizer and keyless entry system. Also refer to "Electronic immobilizer (Anti-theft starting system): Customer F.A.S.T.-key programming" on page 5-28.

5

General information

N00562001075

Your F.A.S.T.-key operates on a radio frequency subject to Federal Communications Commission (FCC) Rules (For vehicles sold in U.S.A.) and Industry Canada Rules (For vehicles sold in Canada). This device com-

Door locks

plies with Part 15 of FCC Rules and Industry Canada licence-exempt RSS standard(s). Operation is subject to the following two conditions.

- This device may not cause harmful interference.
- This device must accept any interference received, including interference that may cause undesired operation.

5

CAUTION

- Changes or modifications not expressly approved by the manufacturer for compliance could void the user's authority to operate the equipment.

Procedure for replacing the remote control transmitter battery

N00562100053

1. Before replacing the battery, remove static electricity from your body by touching a metal grounded object.
2. With the Mitsubishi mark facing you, insert the cloth-covered tip of a flat blade screwdriver into the notch in the remote control transmitter case and use it to open the case.

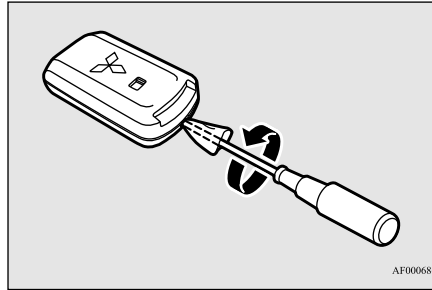

AF0006861

NOTE

- Be sure to perform the procedure with the Mitsubishi mark facing you. If the Mitsubishi mark is not facing you when you open the remote control transmitter case, the transmitter may come out.

3. Remove the old battery.
4. Install a new battery with the + side (A) up.

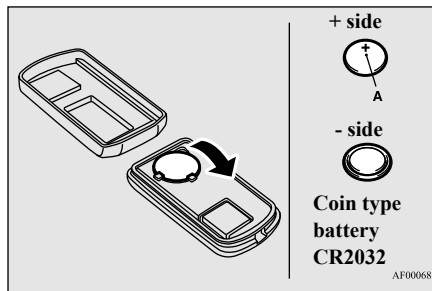

AF0006858

5. Close the remote control transmitter case firmly.
6. Check the keyless entry system to see that it works.

NOTE

- You may purchase a replacement battery at an electric appliance store.
- Your authorized Mitsubishi Motors dealer can replace the battery for you if you prefer.

CAUTION

- When the remote control transmitter case is opened, be careful to keep water, dust, etc. out. Also, do not touch the internal components.

Door locks

N00509200521

WARNING

- Make sure all doors are tightly closed and locked while driving.
- Locked doors, in combination with the use of seat belts, can help reduce the risk of ejection in an accident.
- Locked doors can help keep passengers, especially small children, from opening doors and falling out of moving vehicles.

⚠ WARNING

- Locked doors can help prevent outsiders from gaining access to your vehicle when you slow or come to a stop.
- Lock your vehicle whenever you leave it. Children who get into unlocked vehicles may not be able to get out. Children trapped inside vehicles can quickly be overcome by heat and suffer serious injury or death due to heat stroke.
- Never leave children unattended inside a vehicle. In addition to the risk of heat stroke, children can activate switches and controls, resulting in an injury or fatal accident.

📖 NOTE

- When locking or unlocking with the key, only the driver's door will be locked or unlocked.
To lock or unlock all doors and rear hatch, use the power door lock switches, the keyless entry system, the F.A.S.T.-key operation.
Refer to "Power door locks" on page 5-37, "Keyless entry system" on page 5-7 and 5-30, and "To operate using the F.A.S.T.-key" on page 5-14.
- In vehicles equipped with the F.A.S.T.-key, the driver's door can be locked and unlocked using the emergency key.
Refer to "Emergency key" on page 5-22.

To lock or unlock the doors with the key (driver's door)

Turn the key toward the front of the vehicle to lock the door. After checking that the door is locked, turn the key back to the center and remove it.

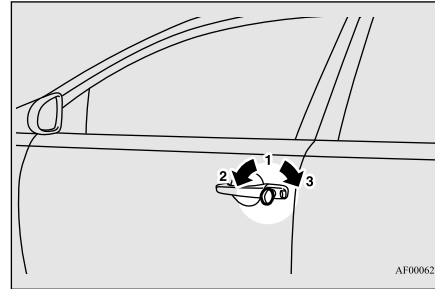

- 1- Insert or remove the key
- 2- Lock
- 3- Unlock

To lock or unlock the door from the inside

Move the lock knob to the lock position to lock the door.
All doors should be kept locked while driving.

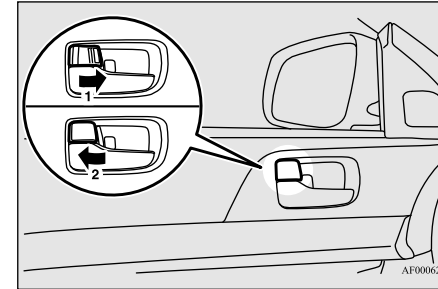

- 1- Lock
- 2- Unlock

The driver's door can be unlocked without using the lock knob by pulling on the inside door handle.

To lock the door without using the key

1. Move the inside lock knob to the locked position.

Door locks

2. Be sure the keys are not inside the vehicle. Close the door.

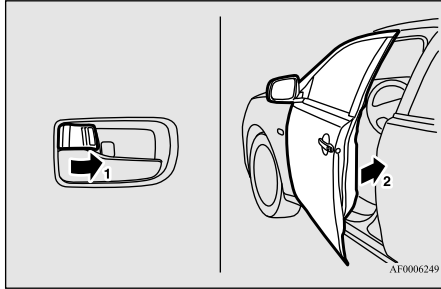

5

Key reminder system

N00549600208

When a key was used to start the engine

Type 1



Type 2



5-36 Features and controls

If the ignition switch is turned off and the driver's door is opened with the key in the ignition switch, the key reminder buzzer will sound intermittently to remind you to remove the key.

The warning display will be displayed on the information screen in the multi-information display.

Lock out protection

N00517300039

When you push the lock knob forward or lock the door with the power door lock switch in both of the following conditions, the lock knob will automatically return to the unlocked position.

- The key is in the ignition switch or the ignition switch is in the "ACC" or "ON" position.
- Driver's door or front passenger door is opened.

Ignition switch return reminder system

N00503800134

When the F.A.S.T.-key was used to start the engine

Type 1



Type 2



If the driver's door is opened while the ignition switch is in a position other than "LOCK" (PUSH OFF), the ignition switch return reminder buzzer will sound intermittently to remind you to return the ignition switch to the "LOCK" (PUSH OFF) position. The warning display will be displayed on the information screen in the multi-information display.

Power door locks

N00509300593

NOTE

- When locking or unlocking with the key on the driver's door, only the driver's door will lock or unlock.
- Repeated continuous operation between lock and unlock could activate the power door locking systems built-in protection circuit and prevent the system from operating. If this occurs, wait about one minute before operating the power door lock switch.

To lock and unlock the doors and rear hatch

Using the power door lock switch

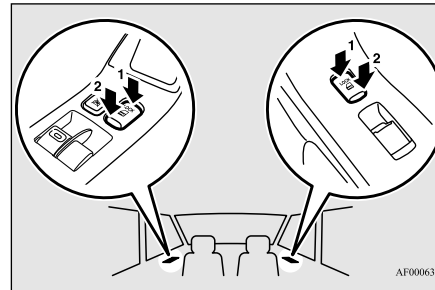

- 1- Lock
- 2- Unlock

All of the doors and the rear hatch can be locked or unlocked by pressing the power door lock switch on the driver's or the front passenger's door.

To unlock the doors and rear hatch

N00563401151

You can select the functions to unlock the doors and rear hatch either using the ignition switch position or using the selector lever {continuously variable transmission (CVT)} position.

These functions are not activated when the vehicle is shipped from the factory. To activate or deactivate these functions, please contact your authorized Mitsubishi Motors dealer.

5

Using the ignition switch position

All doors and the rear hatch will unlock when the ignition switch is turned to the "LOCK" position.

Using the selector lever {continuously variable transmission (CVT)} position

All doors and the rear hatch will unlock when the selector lever is moved to the "P" (PARK) position with the ignition switch in the "ON" position.

“Child safety locks” for rear door

5

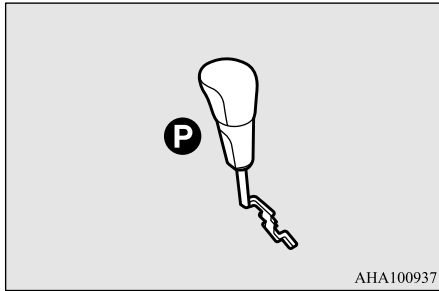

Child safety locks help prevent rear passengers, especially children, from opening the rear door using the inside door handle.

A lock lever for the child safety lock is provided on each rear door.

When the lever is in the lock position (1), the rear door cannot be opened using the inside door handle.

To open the rear door when the child safety lock lever is in the lock position, pull the outside door handle.

When the lever is in the release position (2), the child safety lock is released and the rear door can be opened using the inside door handle.

“Child safety locks” for rear door

N00509400204

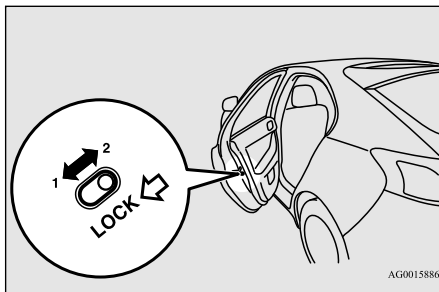

- 1- To lock
- 2- To release

⚠ WARNING

- Always keep the doors tightly closed and locked when driving. An unlocked door may be accidentally opened by a passenger, especially by a child who could fall out. Also, if the doors are not locked, there is a greater risk of someone being thrown from the vehicle in an accident.

Rear hatch

N00510001076

⚠ WARNING

- The luggage compartment was not designed for people to ride in it. Do not let passengers ride in or let children play in the luggage compartment. Riding or playing in the luggage compartment could result in a serious accident or injury.
- Before driving, be sure that the rear hatch is securely closed. It is dangerous to drive with the rear hatch open since carbon monoxide (CO) gas contained in engine exhaust gases can enter the passenger compartment. CO is an invisible, odorless gas that can cause unconsciousness and even death. In addition, if the rear hatch opens while driving, luggage could fall onto the road and cause an accident.
- When opening and closing the rear hatch, make sure that there are no people nearby and that there is sufficient space behind and above the vehicle. In addition, be careful not to hit your head or pinch your hands, neck, etc.
- If snow or ice has accumulated on the rear hatch, remove it before opening the rear hatch. Otherwise the rear hatch may abruptly close due to the weight of the snow or ice.

Rear hatch

⚠ WARNING

- When opening the rear hatch, always fully open it. A partially opened rear hatch can unexpectedly close due to its own weight.
- When the vehicle is parked on a slope, the effort required to open or close the rear hatch may be greater or less than expected. The rear hatch may also open or close more quickly.

⚠ CAUTION

- Do not stand behind the exhaust pipe when loading and unloading luggage. Heat from the exhaust could lead to burns.
- To avoid damage to the rear hatch, make sure the area above and behind the rear hatch is clear before opening it.

📖 NOTE

- Locking and unlocking the doors by using the power door locks (driver and front passenger side), keyless entry system, or F.A.S.T.-key operation (if so equipped) also locks and unlocks the rear hatch.

To open

After unlocking, press the rear hatch OPEN switch (A) and lift the rear hatch.

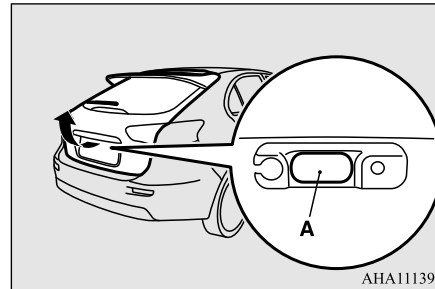

AHA111399

📖 NOTE

- The rear hatch cannot be opened if it is not raised immediately after pressing the rear hatch OPEN switch. If this happens, press the rear hatch OPEN switch again and raise the rear hatch.
- The rear hatch cannot be opened when the battery is discharged or disconnected. The rear hatch must then be opened using the inside rear hatch release.
- When the battery is reconnected, all doors and the rear hatch will be locked. Unlock them before trying to open the rear hatch.

To close

Pull the rear hatch grip (A) downward as illustrated and release it before the rear hatch closes completely. Gently slam the rear hatch from the outside so that it is completely closed.

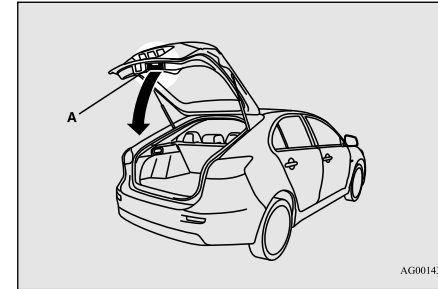

AG0014368

⚠ CAUTION

- To avoid injuring your hand or arm, do not attempt to close the rear hatch without releasing the rear hatch grip (A).

5

Inside rear hatch release

5

NOTE

- Gas struts (B) are installed in the locations illustrated in order to support the rear hatch.

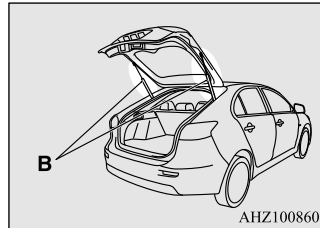

Please observe the following in order to prevent damage or faulty operation.

- Do not touch, push or pull the gas struts when closing the rear hatch.
- Do not attach any plastic material, tape, etc., to the gas struts.
- Do not tie string, etc., around the gas struts.
- Do not hang objects on the gas struts.

Inside rear hatch release

N00523101101

The inside rear hatch release is designed to provide a way to open the rear hatch if the battery is dead or disconnected.

The rear hatch release lever (see illustration) is mounted on the rear hatch.

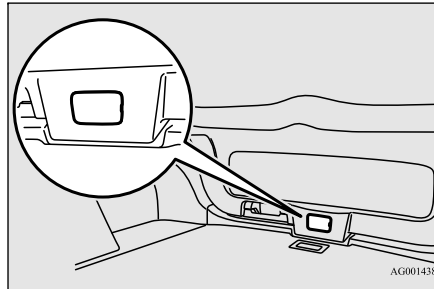

You and your family should familiarize yourselves with the location and operation of the rear hatch release lever.

To open

1. Open the lid (A) inside of the rear hatch.

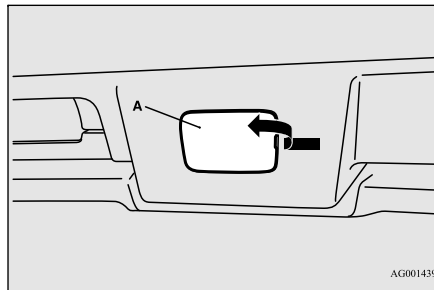

2. Move the lever (B) to open the rear hatch.

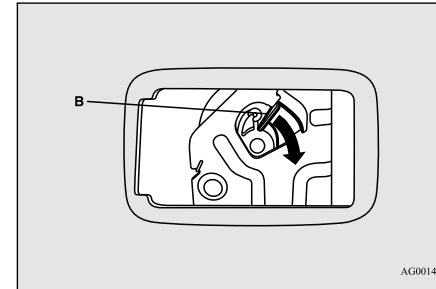

3. Push out on the rear hatch to open it.

WARNING

- Always keep the release lever lid on rear hatch closed when driving so that your luggage cannot accidentally bump the lever and open the rear hatch.

Theft-alarm system

N00510200215

The theft-alarm system is designed to provide protection from unauthorized entry into the vehicle. This system is operated in three stages: the first is the “armed” stage, the second is the “alarm” stage, and third is the “disarmed” stage. If triggered, the system provides both audible and visual alarm signals.

Theft-alarm system

CAUTION

- Do not modify or add parts to the theft-alarm system. Doing so could cause the theft-alarm to malfunction.

Armed stage

N00510301196

Park the vehicle and stop the engine. Arm the system as described below.

- Turn the ignition switch to the "LOCK" position.
Also, if a key was used to start the engine, remove the key from the ignition switch.
- Make sure that the engine hood is closed.
- Lock all doors and the rear hatch by using the keyless entry system or the F.A.S.T.-key operation.

Arm the system and leave

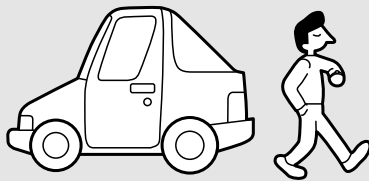

AA0056858

At this time, the theft-alarm indicator (A) on the audio panel flashes for confirmation.

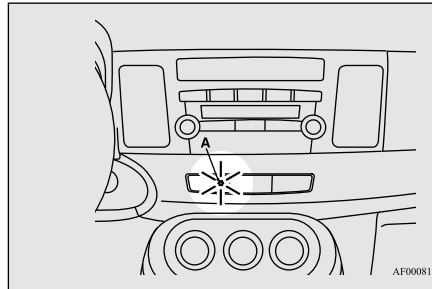

AF0008155

- The system has entered the armed stage after about 20 seconds, when the theft-alarm indicator (A) flashing becomes slower.
The theft-alarm indicator (A) continues to flash while the system is in the armed stage.

NOTE

- If the engine hood is open, the theft-alarm indicator (A) illuminates and the system cannot enter the armed stage. The system enters the armed stage about 20 seconds after the engine hood is closed.

NOTE

- The system will be disarmed if, while the theft-alarm indicator (A) is illuminated, all doors and rear hatch are unlocked by using the keyless entry system or the F.A.S.T.-key operation.
- The system will be disarmed if, while the theft-alarm indicator is illuminated, the ignition switch is turned to the "ON" position.
- The system will not be armed if a door or the rear hatch or the engine hood is not completely closed. If this happens, rearm the system as described above.
- The theft-alarm system can be activated when people are riding inside the vehicle or when the windows are open. To prevent accidental activation of the alarm, do not set the system to the system armed mode while people are riding in the vehicle.

5

Alarm stage

N00510401201

The alarm will be activated if any of the following occur while the vehicle is parked and the system is armed.

- One of the doors and the rear hatch is opened without using the keyless entry system or the F.A.S.T.-key operation.
- The engine hood is opened.

Theft-alarm system

Type of alarm

When the alarm is activated:

1. The headlights blink on and off for 3 minutes.
After 3 minutes the headlights automatically shut off.
2. The horn will sound intermittently for 3 minutes.

5

Horn sounds!
Headlights blink on and off!



AF0008168

NOTE

- The alarm will continue to operate for 3 minutes. At the end of that period, the alarm will automatically shut off to save battery power. The system will then be rearmed until the proper disarming step is taken.
- The alarm will resume if unauthorized actions are taken again, even if the alarm has stopped.

NOTE

- While the alarm is operating, a warning is displayed on the information screen in the multi-information display.

Type 1



Type 2



Alarm deactivation

The alarm can be deactivated in the following ways.

- By using the keyless entry system or the F.A.S.T.-key operation to lock or unlock the door or rear hatch.
- Turn the ignition switch to the “ON” position.

Disarmed stage

N00510501185

The system will be disarmed if the following operation is performed.

- The ignition switch is turned to the “ON” position.
- All doors and the rear hatch are unlocked by the keyless entry system or the F.A.S.T.-key operation.

Disarm...by using the keyless entry system or F.A.S.T.-key operation

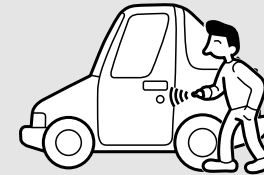

AA0070940

NOTE

- If the UNLOCK button on the remote control transmitter, or the driver's or front passenger's door lock/unlock switch is pressed when all doors and the rear hatch are closed and no door is opened within approximately 30 seconds, re-arming will automatically occur.

Power windows

NOTE

- The amount of time after unlocking until the vehicle relocks automatically can be adjusted. See an authorized Mitsubishi Motors dealer for details.
- Once the system has been disarmed, it cannot be rearmed except by repeating the arming procedure.

Testing the theft-alarm system

N00510601131

Use the following procedure to test the system:

1. Lower the driver's window.
2. Arm the system as explained in "Armed stage".
3. Make sure that the theft-alarm indicator comes on and flashes for approximately 20 seconds.
4. Wait a few seconds and then unlock the driver's side door by using the inside door lock knob and open the door.
5. Check to be sure that the horn sounds intermittently and the headlights blink on and off when the door is opened.
6. Disarm the system by unlocking all doors and the rear hatch by using the keyless entry system or the F.A.S.T.-key operation.

Power windows

N00510800325

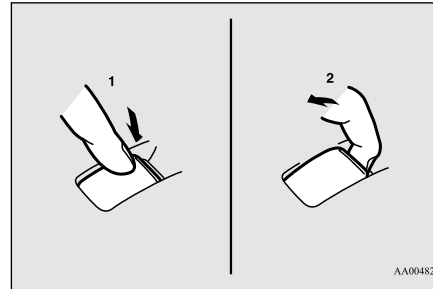

- 1- Open (down)
- 2- Close (up)

NOTE

- Never try to operate the main switch and sub switch in different directions at the same time. This will freeze the window in position.
- Operating the power windows repeatedly with the engine stopped will run down the battery. Use the window switches only while the engine is running.

WARNING

- Before operating the power windows, make sure that nothing can be trapped (head, hands, fingers, etc.) in the window.

WARNING

- Never leave the vehicle with the key in the ignition switch.
- Never leave a child alone in the vehicle.

Main switch

5

The main switch located on the driver's door can be used to operate all door windows. A window can be opened or closed by operating the corresponding switch. Press the switch down to open the window, and pull up the switch to close it. If the driver's door window switch is fully pressed down/pulled up, the driver's door window automatically opens/closes completely. If you want to stop the window movement, operate the switch lightly in the reverse direction.

Power windows

5

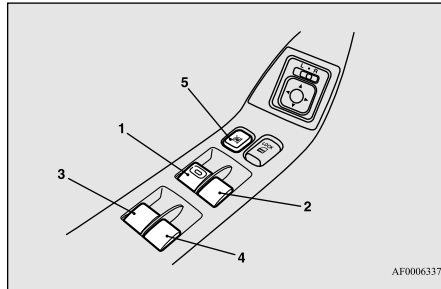

- 1- Driver's door window switch
- 2- Front passenger door window switch
- 3- Left rear door window switch
- 4- Right rear door window switch
- 5- Window lock switch

Sub switch

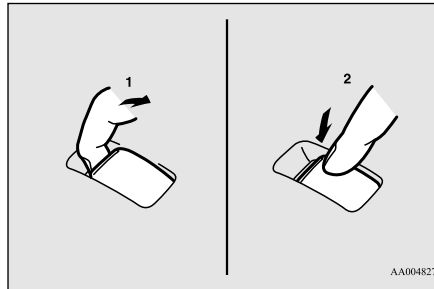

- 1- Close (up)
- 2- Open (down)

Each sub switch can be used for its own passenger door window, unless the driver's window lock switch is activated.

Timer function

The power windows can be run up or down when the ignition switch is in the "ON" position.

The door windows can be opened or closed for a 30 second period after the ignition switch is turned to the "ACC" or "LOCK" position. However, once the driver's door or the front passenger's door is opened, the power windows cannot be operated.

Safety mechanism (Driver's door window only)

N0052880089

If a hand or head is trapped, for safety the door window is automatically lowered a little. After the door window is lowered, pull up the switch again to close the door window.

⚠ WARNING

- If the safety mechanism is activated three or more times successively, the safety mechanism will be temporarily cancelled. If a hand or head subsequently gets trapped, a serious injury can result.
- The safety mechanism is deactivated while the switch is pulled up continuously. Therefore be especially careful that hands or head are not trapped in the door window opening.
- Do not deliberately trap your hands or head in order to activate the safety mechanism. Your hand or head could be trapped and personal injury could result.

⚠ CAUTION

- The safety mechanism is deactivated just before the door window closes. This allows the door window to close completely. Therefore be especially careful that fingers are not trapped in the door window opening.

NOTE

- The safety mechanism can be activated if the driving conditions or other circumstances cause the door window to be subjected to a physical shock similar to that caused by trapped hand or head.
- If the safety mechanism is activated 3 or more times consecutively, the safety mechanism is deactivated and normal closing of the door window will be aborted. Use the following method to return to normal operation.
 1. If the door window is open, repeatedly pull up the power window switch to fully close the door window.
 2. With fully closing the window, release the switch and then pull up the switch again for about 1 second.

Lock switch

N00549000127

When this switch is in the lock mode, the main switch for passenger door window and the sub switch cannot be used to open or close the door window, and the main switch will open or close only the driver's door window. To unlock the switch, press it again.

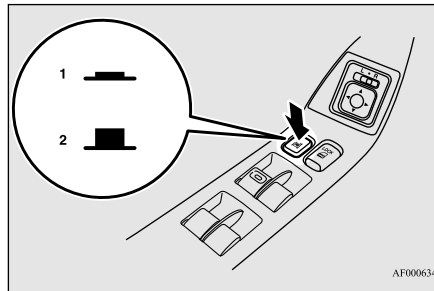

- 1- Lock
- 2- Unlock

WARNING

- Before driving with a child in the vehicle, be sure to lock the window switch to make it inoperative. Children tampering with the switch could easily trap their hands or heads in the window.

Sunroof (if so equipped)

What to do if you hear wind buffeting when driving

N00551400014

Wind buffeting can be described as the perception of pressure on the ears or a booming or rumbling sound. Your vehicle may exhibit wind buffeting when driving with one or both rear door windows down or partially opened. This is a normal occurrence that can be minimized. If the buffeting occurs with the rear door windows open, open the front door windows as well as the rear door windows to minimize the condition.

5

Sunroof (if so equipped)

N00511000669

WARNING

- Do not stick your head, hands or anything else in the sunroof opening.
- Before operating the sunroof, make sure that nothing can be trapped (head, hands, fingers, etc.).
- Never leave a child (or other person who is incapable of safely operating the sunroof switch) alone in the vehicle.

The sunroof can be opened and closed with the ignition switch in the "ON" position.

Sunroof (if so equipped)

5

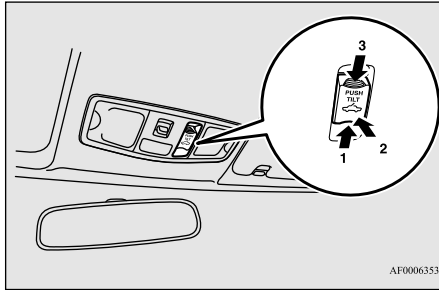

AF0006353

To open

Press the switch (1), the sunroof automatically opens and the sunroof will stop several centimeters this side of the full open position. Press the switch (1) again, and the sunroof will be fully open.

To stop the moving sunroof, press the switch.

NOTE

- The sunroof stops just before reaching the fully open position. If the vehicle is driven with the sunroof in this position, wind buffeting is lower than with the sunroof fully open.

To close

Press the switch (3), the sunroof automatically closes.

To stop the moving sunroof, press the switch.

To tilt up

When the switch (2) is pressed, the rear edge of sunroof raises for ventilation.

To tilt down

Press the switch (3).

Timer function

The sunroof can be operated when the ignition switch is in the “ON” position. The sunroof can be opened or closed for a 30 seconds period after the ignition switch is turned to the “ACC” or “LOCK” position. However, once the driver’s door or the front passenger’s door is opened, the sunroof cannot be operated until the ignition switch is turned on again.

Safety mechanism

If a hand or head is trapped in the closing sunroof opening, the safety mechanism will cause the sunroof to re-open automatically. The opened sunroof will become operational again after a few seconds.

If the safety mechanism is activated 5 or more times consecutively, normal closing of the sunroof will be aborted.

As an emergency measure, the sunroof can be closed in small increments until it is completely closed by repeatedly pressing the switch (2).

After performing the emergency measure, consult an authorized Mitsubishi Motors dealer.

NOTE

- The safety mechanism can be activated if the driving conditions or other circumstances cause the sunroof to be subjected to a physical shock similar to that caused by a trapped hand or head.

WARNING

- The safety mechanism is deactivated while the switch (2) is pressed continuously. Therefore be especially careful that hands or head are not trapped in the sunroof opening.

Sunroof (if so equipped)

⚠ WARNING

- Do not deliberately trap your hands or head in order to activate the safety mechanism. Personal injury and malfunction of the sunroof could result.

⚠ CAUTION

- The safety mechanism is deactivated just before the sunroof closes. This allows the sunroof to close completely. Therefore be especially careful that fingers are not trapped in the sunroof opening.

Sunshade

The sunshade can be opened or closed manually while the sunroof is closed. When the sunroof is opened, the sunshade will also open automatically.

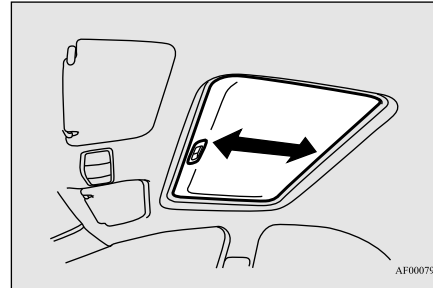

⚠ CAUTION

- Do not attempt to close the sunshade when the sunroof is opened.
- Be careful that hands are not trapped when closing the sunshade.

📖 NOTE

- Be sure to tilt down the sunroof before closing the sunshade.
- When leaving the vehicle unattended, be sure to close the sunroof and without the ignition key.
- Do not try to operate the sunroof if it is frozen closed (after snowfall or during extreme cold).
- Do not sit on or place heavy luggage on the sunroof or roof opening edge.
- Do not apply any force that may cause damage to the sunroof.

📖 NOTE

- Release the switch when the sunroof has reached a completely open or completely closed position.
- If the sunroof does not operate when the sunroof switch is operated, release the switch and check whether something is trapped by the sunroof. If nothing is trapped, have the sunroof checked at an authorized Mitsubishi Motors dealer.
- Be careful when tilting up the sunroof if a ski carrier or a roof carrier is installed. Depending on the model of ski carrier or roof carrier, the sunroof may contact the carrier when the sunroof is tilted up.
- Be sure to close the sunroof completely when washing the vehicle or when leaving the vehicle.
- Do not put any wax on the weatherstrip (black rubber) around the sunroof opening. If it is waxed, the weatherstrip cannot maintain a weatherproof seal with the sunroof.
- After washing the vehicle or after rain be sure to wipe off any water that is on the sunroof before operating it.
- Operating the sunroof repeatedly with the engine turned off will run down the battery. Operate the sunroof only while the engine is running.

Parking brake

Parking brake

N00511401442

To park the vehicle, first bring it to a complete stop and fully engage the parking brake. For vehicles with a manual transaxle, move the gear shift lever to 1st (on a uphill) or “R” (Reverse) (on a downhill) position.

5

For vehicles with a continuously variable transmission (CVT), set the selector lever to “P” (PARK) position.

To apply

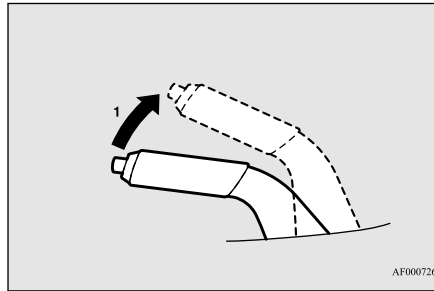

- 1- Pull the lever up without pushing the button at the end of hand grip. When the parking brake is set and the ignition switch is in the “ON” position, the brake warning light in the instrument cluster will come on.

Before driving, be sure to release the parking brake.

To release

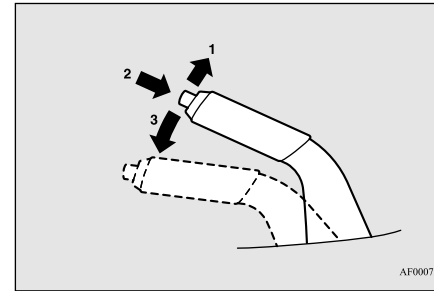

- 1- Pull the lever up slightly.
- 2- Push and hold the button at the end of the hand grip.
- 3- Push the lever downward.

When parking on a hill, apply the parking brake and turn the front wheels toward the curb on a downhill grade, away from the curb on an uphill grade.

Steering wheel tilt lock lever

CAUTION

- Before driving, be sure that the parking brake is fully released and brake warning light is off.
- If you drive without the parking brake fully released, the warning display will appear on the information screen in the multi-information display.
- If a vehicle is driven without releasing the parking brake, the brakes will be overheated, resulting in ineffective braking and possible brake failure.

Warning light



Warning display type 1



Warning display type 2



Steering wheel tilt lock lever

N00511500172

To adjust the steering wheel height, release the tilt lock lever while holding the steering wheel by hand, and raise or lower the steering wheel to the desired height. After adjustment, securely lock the lever by pulling it upward.

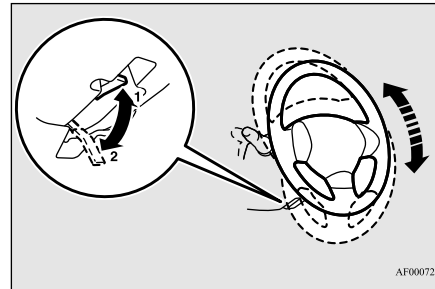

- 1- Locked
- 2- Released

WARNING

- After adjusting, make sure the lock lever is secured in the locked (1) position.
- Do not attempt to adjust the steering wheel while driving. This can be dangerous.

WARNING

- When releasing the tilt lock lever {moving it to the position (2)}, be sure to hold the steering wheel firmly. Otherwise, the steering wheel may slip down too suddenly.

Inside day/night rearview mirror

5

N00548601093

Adjust the inside rearview mirror only after making any seat adjustments so as to have a clear view to the rear of the vehicle.

WARNING

- Do not attempt to adjust the inside rearview mirror while driving. This can be dangerous. Be sure to adjust the mirror before driving.

Outside rearview mirrors

5

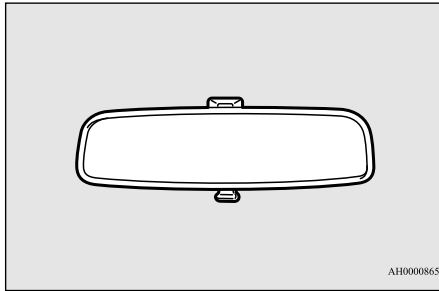

Adjust the inside mirror to maximize the view through the rear window.

To adjust the vertical mirror position

It is possible to move the mirror up and down to adjust its position.

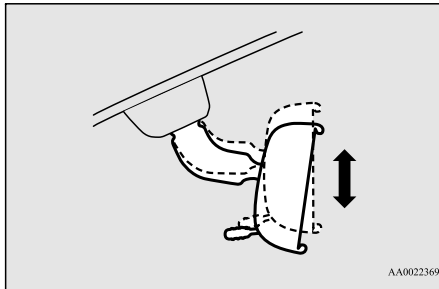

To adjust the mirror position

It is possible to move the mirror up/down and left/right to adjust its position.

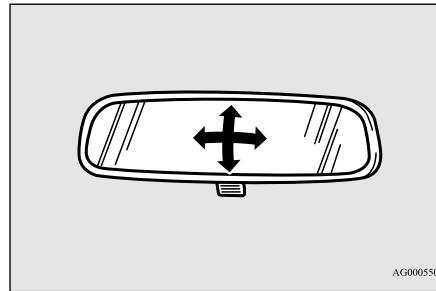

To reduce the glare

The day/night knob (A) at the bottom of the mirror can be used to adjust the mirror to reduce the glare from the headlights of vehicles behind you during night driving.

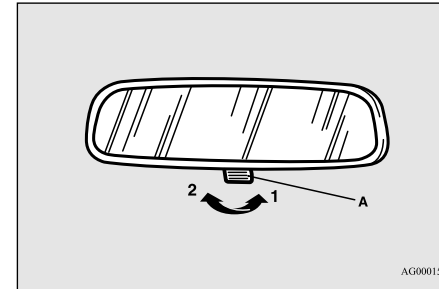

- 1- Daytime position
- 2- Night position

Outside rearview mirrors

N00512201261

Adjust the outside rearview mirrors only after making any seat adjustments so you have a clear view to the rear of the vehicle.

⚠ WARNING

- Do not attempt to adjust the outside rearview mirrors while driving. This can be dangerous. Be sure to adjust the mirrors before driving.

Outside rearview mirrors

⚠ WARNING

- **Your passenger's side mirror is convex. The objects you see in the mirror will look smaller and farther away than they appear in a regular flat mirror. Do not use this mirror to estimate the distance of vehicles following you when changing lanes.**

To adjust the mirror position

The outside rearview mirrors can be adjusted when the ignition switch is in the "ON" or "ACC" position. Move the lever (A) to the same side as the mirror you wish to adjust.

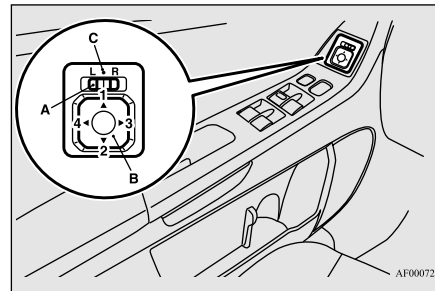

- L- Left outside mirror adjustment
- R- Right outside mirror adjustment

Press the switch (B) to adjust the mirror position.

- 1- Up
- 2- Down
- 3- Right
- 4- Left

📖 NOTE

- After adjusting, return the lever to the "•" (off) position (C).

To fold the mirror

The outside mirror can be folded in toward the side window to prevent damage when parking in tight locations.

5

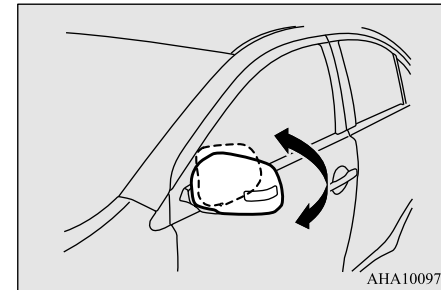

Heated mirror

N00549301244

When the rear window defogger switch is pressed with the engine running, the outside rearview mirrors are defogged or defrosted. Current will flow through the heater element inside the mirrors, thus clearing away frost or condensation.

Ignition switch

The indicator light (A) will illuminate while the defogger is on.
The heater will be turned off automatically in about 20 minutes.

5

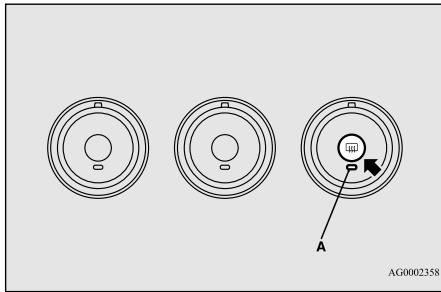

Ignition switch

N00512401700

[For vehicles equipped with the F.A.S.T.-key]

For information on operations for vehicles equipped with the F.A.S.T.-key, refer to “F.A.S.T.-key: Ignition switch” on page 5-16.

[Except for vehicles equipped with the F.A.S.T.-key]

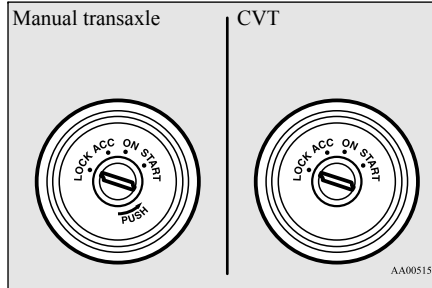

LOCK

The engine is off and the steering wheel is locked. The key can be inserted and removed only when the switch is in this position.

ACC

Allows operation of electrical accessories with the engine off.

ON

The engine runs and all accessories can be used.

START

Engages the starter. After the engine starts, release the key and it will return automatically to the “ON” position.

NOTE

- Your vehicle is equipped with an electronic immobilizer. To start the engine, the ID code which the transponder inside the key sends must match the one registered to the immobilizer computer. (Refer to “Electronic immobilizer” on page 5-4.)

ACC power auto-cutout function

N00539601097

After about 30 minutes has elapsed with the ignition switch in the “ACC” position, the function automatically cuts out the power for the audio system and other electric devices that can be operated with that position.

When the ignition switch is turned from the “ACC” position, the power is supplied again to those devices.

NOTE

- It is possible to modify functions as follows:

Steering wheel lock

NOTE

- The time until the power cuts out can be changed to about 60 minutes.
- The ACC power auto-cutout function can be deactivated.

For details, consult a Mitsubishi Motors dealer.

To remove the key

N00550901224

For vehicles equipped with a manual transaxle, when removing the key, push the key in at the “ACC” position and keep it depressed until it is turned to the “LOCK” position, and remove.

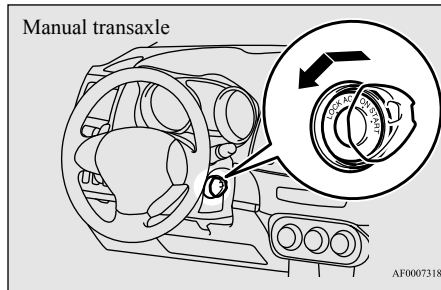

For vehicles equipped with a continuously variable transmission (CVT), when removing the key, first set the selector lever to the

“P” (PARK) position, and then turn the key to the “LOCK” position, and remove.

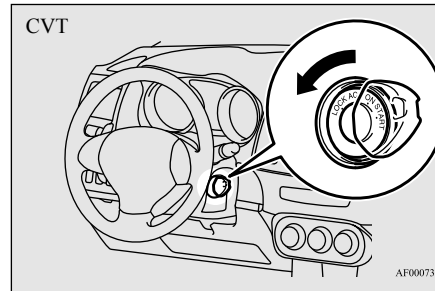

NOTE

- For vehicles equipped with a CVT, the key cannot be removed unless the selector lever is set to the “P” (PARK) position, which allows the ignition switch to turn to the “LOCK” position.

CAUTION

- Do not remove the ignition key from the ignition switch while driving. The steering wheel will lock, causing loss of control.
- If the engine is turned off while driving, the power brake booster will stop functioning and braking efficiency will be reduced. Also, the power steering system will not function and it will require greater effort to manually steer the vehicle.

CAUTION

- Do not leave the key in the “ON” position for a long time when the engine is not running. This will cause the battery to run down.
- Do not turn the key to the “START” position when the engine is running. It will damage the starter motor.

Steering wheel lock

N00512500179

[For vehicles equipped with the F.A.S.T.-key]

For information on operations for vehicles equipped with the F.A.S.T.-key, refer to “F.A.S.T.-key: Steering wheel lock” on page 5-20.

[Except for vehicles equipped with the F.A.S.T.-key]

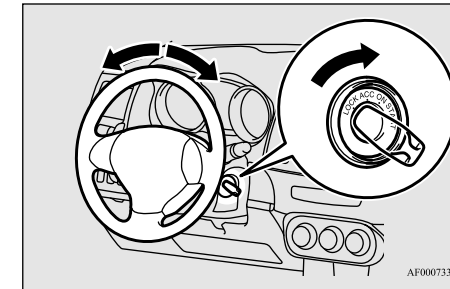

Starting and stopping the engine

To lock

Remove the key at the “LOCK” position.
Turn the steering wheel until it is locked.

To unlock

Turn the key to the “ACC” position while moving the steering wheel slightly.

CAUTION

- Remove the key when leaving the vehicle.

NOTE

- If the front wheels are turned, the anti-theft lock may sometimes make it difficult to turn the key from “LOCK” position to “ACC” position. Firmly turn the steering wheel to the left or to the right as you turn the key.

Starting and stopping the engine

N00542101083

Tips for starting

- Do not operate the starter motor continuously for longer than 15 seconds as this could run the battery down or damage the starter motor. If the engine does not start, turn the ignition switch back to the “LOCK” position, wait a few seconds, and then try again. Trying repeatedly with the engine or starter motor still turning will damage the starter mechanism.
- If the engine will not start because the battery is weak or discharged, refer to “Jump-starting the engine” (on page 8-2) for instructions.
- The engine is warmed up enough for driving when the bar graph of engine coolant temperature display starts to move. A longer warm up period will only consume extra fuel.

WARNING

- Never run the engine in a closed or poorly ventilated area any longer than is needed to move your vehicle out of the area. Carbon monoxide gas, which is odorless and extremely poisonous, could build up and cause serious injury or death.

CAUTION

- Do not push-start the vehicle.
- Do not run the engine at high rpms or drive at high speeds until the engine has had a chance to warm up.
- Release the ignition switch as soon as the engine starts. Otherwise, the starter motor will be damaged.

Starting the engine

N00542201202

[For vehicles equipped with the F.A.S.T.-key]

For information on operation for vehicles equipped with the F.A.S.T.-key, refer to “F.A.S.T.-key: Starting the engine” on page 5-20.

[Except for vehicles equipped with the F.A.S.T.-key]

Your vehicle is equipped with an electronically controlled fuel injection system, which

automatically controls the release of fuel. There is usually no need to depress the accelerator pedal when starting the engine. The starter should not be run for more than 15 seconds at a time. To prevent battery drain, wait a few seconds between attempts to restart the engine.

1. Make sure all occupants are properly seated with seat belts fastened.
2. Insert the ignition key.
3. Make sure the parking brake is applied.
4. Press and hold the brake pedal down firmly with your right foot.
5. Press and hold the clutch pedal all the way down (manual transaxle).

NOTE

- For models equipped with a manual transaxle, the starter will not operate unless the clutch pedal is fully depressed (Clutch interlock). This is a safety feature.

6. On vehicles equipped with manual transaxle, place the gearshift lever in the “N” (Neutral) position.
On vehicles equipped with continuously variable transmission (CVT), make sure the selector lever is in the “P” (PARK) position.

NOTE

- On vehicles equipped with CVT, the starter will not operate unless the selector lever is in the “P” (PARK) or “N” (NEUTRAL) position.
For safety reasons, start the engine in the “P” (PARK) position so that the wheels are locked.

7. Turn the ignition switch to the “ON” position and make certain that all warning lights are functioning properly before starting the engine.
8. Turn the ignition switch to the “START” position without pressing the accelerator pedal. Release the key when the engine starts.

NOTE

- Minor noises may be heard on engine start-up. These will disappear as the engine warms up.

When the engine is hard to start

After several attempts, you may experience that the engine still does not start.

1. Make sure that all electric devices, such as lights, air conditioning blower and rear window defogger, are turned off.

Starting and stopping the engine

2. While depressing the brake pedal on vehicles equipped with continuously variable transmission (CVT) or the clutch pedal on the vehicles equipped with manual transaxle, press the accelerator pedal halfway and hold it there, then crank the engine. Release the accelerator pedal, immediately after the engine starts.
3. If the engine still will not start, the engine could be flooded with too much gasoline. While depressing the brake pedal on vehicles equipped with CVT or the clutch pedal on the vehicles equipped with manual transaxle, push the accelerator pedal all the way down and hold it there, then crank the engine for 5 to 6 seconds. Return the ignition switch to the “LOCK” position and release the accelerator pedal. Wait a few seconds, and then crank the engine again for 5 to 6 seconds while depressing the brake pedal or the clutch pedal, but do not push the accelerator pedal. Release the ignition key if the engine starts. If the engine fails to start, repeat these procedures. If the engine still will not start, contact your local Mitsubishi Motors dealer or a repair facility of your choice for assistance.

Manual transaxle (if so equipped)

Startability of continuously variable transmission (CVT) vehicles at extremely cold ambient temperature

5

When the ambient temperature is -4°F (-20°C) or lower, it may not be possible to start from a stand-still even with the selector lever in the “D” (DRIVE) or “R” (REVERSE) position.

This phenomenon occurs because the transaxle has not warmed up sufficiently; it does not indicate a problem. If it occurs, place the selector lever in the “P” (PARK) position and let the engine idle for at least 10 minutes.

The transaxle will warm up, and you will be able to start normally.

Do not leave the vehicle during warm-up operation.

Stopping the engine

N00542301098

1. Bring the vehicle to a complete stop.
2. Fully engage the parking brake while depressing the brake pedal.
3. For vehicles equipped with a manual transaxle, turn the ignition switch to the “LOCK” position to stop the engine, and then move the gearshift lever to the 1st (on a uphill) or “R” (Reverse) (on a downhill) position.

5-56 Features and controls

For vehicles equipped with continuously variable transmission (CVT), place the selector lever in the “P” (PARK) position, and then turn the ignition switch to the “LOCK” position to stop the engine.

Manual transaxle (if so equipped)

N00512701178

The shift pattern below is shown on the gearshift lever. Press the clutch pedal all the way down while shifting gears.

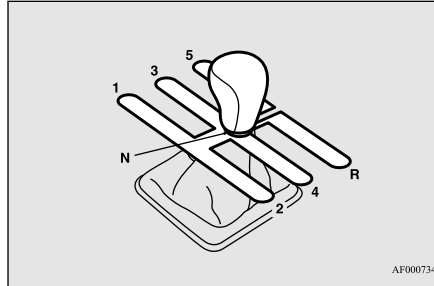

AF0007347

NOTE

- During cold weather, shifting may be difficult until the transaxle lubricant has warmed up. This is normal and not harmful to the transaxle.

To start

Press the clutch pedal all the way down and shift into 1st or “R” (Reverse) position. Then gradually release the clutch pedal while depressing the accelerator pedal.

CAUTION

- Do not move the gearshift lever into reverse while the vehicle is moving forward; doing so will damage the transaxle.
- Do not rest your foot on the clutch pedal because this will cause premature clutch wear or damage.
- Do not coast in the “N” (Neutral) position (illegal in many states).
- Do not use the gearshift lever as a handrest, because this can result in premature wear of the transaxle shift forks.

NOTE

- If it is hard to shift into 1st, depress the clutch pedal a second time; the shift will then be easier.
- To shift into reverse from 5th gear, move the gearshift lever to the “N” (Neutral) position, and then shift it into reverse.

Proper shift points

N00537400049

Always use care to change the gear with the vehicle speed matched to the engine speed. Proper shifting will improve fuel economy and prolong engine life.

CAUTION

- Avoid downshifting that may cause the tachometer pointer to enter the red zone. This puts the engine at risk of being damaged.

Changing gears while the vehicle is moving

N00548101027

Always use care to change the gear with the vehicle speed matched to the engine speed. Proper shifting will improve fuel economy and prolong engine life.

Avoid shifting down at high speed, as this may cause excessive engine speed (the tachometer needle into the red zone) and damage the engine.

NOTE

- The gearshift indicator shows recommended gearshift points for fuel-efficient driving. It shows a “▲” when an upshift is recommended, and it shows a “▼” when a downshift is recommended.

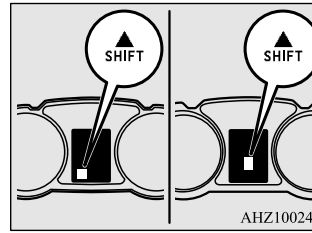

Upshifting

N00512900131

For the best fuel economy and performance in using your manual transaxle, upshift as listed below.

At low altitude locations, shift at the vehicle speeds listed. Upshifting earlier during cruise conditions (relatively steady speeds) will improve your fuel economy.

Manual transaxle (if so equipped)

Shift point	Upshift speeds	
	Acceleration	Cruise
1st gear to 2nd gear	15 mph (24 km/h)	15 mph (24 km/h)
2nd gear to 3rd gear	28 mph (45 km/h)	19 mph (31 km/h)
3rd gear to 4th gear	36 mph (58 km/h)	33 mph (53 km/h)
4th gear to 5th gear	45 mph (72 km/h)	45 mph (72 km/h)

5

At high altitude locations, upshift as listed below.

Shift point	Upshift speeds
1st gear to 2nd gear	15 mph (24 km/h)
2nd gear to 3rd gear	25 mph (40 km/h)
3rd gear to 4th gear	40 mph (64 km/h)
4th gear to 5th gear	45 mph (72 km/h)

Downshifting

N00513000096

It is recommended that you downshift to a lower gear when needed to maintain the desired speed, according to the table. Avoid downshifting at too high a speed. The engine may suffer damage.

Continuously variable transmission (CVT) (if so equipped)

To maintain a safe speed and prolong brake life, shift down to 2nd or 1st when descending a steep hill.

Downshifting is also important to avoid “lugging” the engine at too low a speed, such as when turning a corner or when driving up a steep hill.

5

Recommended downshifting speed

Downshifting speed	Shift point
Under 20 mph (32 km/h)	Shift down from current gear to 2nd gear.
20 to 30 mph (32 to 48 km/h)	Shift down from current gear to 3rd gear.

Driving precautions

N00513100231

- Do not use the gearshift lever as a handrest. This can result in premature wear of the transaxle shift forks.

Maximum possible driving speed

Shift points	Maximum possible driving speed
1st gear	31 mph (50 km/h)
2nd gear	62 mph (100 km/h)

5-58 Features and controls

Shift points	Maximum possible driving speed
3rd gear	87 mph (140 km/h)
4th gear	121 mph (195 km/h)

- The table above shows the maximum recommended driving speed for in each gear. Do not drive near or at these speeds for prolonged periods of time.

Continuously variable transmission (CVT) (if so equipped)

N00513200229

The CVT will automatically and continuously change its gear ratio depending on road and driving conditions. This helps achieve smooth driving and excellent fuel efficiency. Also you can manually shift up and shift down the transmission. Refer to “Sports mode” on page 5-62.

DRIVING UPHILL

The transmission prevents unnecessary upshifts even when the accelerator pedal is released and ensures smooth driving.

DRIVING DOWNHILL

According to the conditions, the transmission will automatically shift to a lower gear ratio to achieve stronger engine braking. This may help reduce your need to use the service brake.

Selector lever operation

N00513801411

As an additional safety precaution, models equipped with a CVT have a shift-lock device that holds the selector lever in the “P” (PARK) position. To move the selector lever from the “P” (PARK) position to another position, follow the steps below.

- Press and hold the brake pedal down.
- Move the selector lever to the desired position.

NOTE

- The selector lever cannot be moved from “P” (PARK) to another position if the ignition switch is at the “LOCK” or “ACC” position, or the key has been removed, or if the brake pedal is not pressed and held down.

The CVT has 2 forward selector positions and 1 reverse selector position.

Continuously variable transmission (CVT) (if so equipped)

The CVT selects an optimum ratio automatically when the selector lever is in the “D” (DRIVE) or “L” (LOW) position, depending on the speed of the vehicle and the position of the accelerator pedal.

The selector lever has 5 positions.

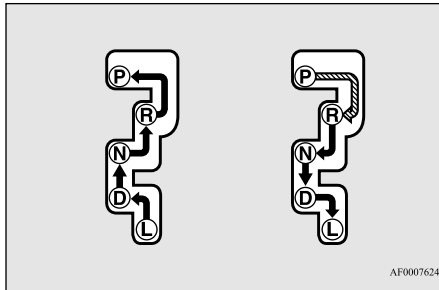
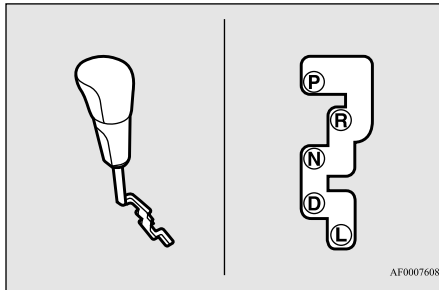

With the brake pedal depressed, set the selector lever in the gate to operate.



Set the selector lever in the gate to operate.

WARNING

- Always depress the brake pedal when shifting the selector lever into a selector position from the “P” (PARK) or “N” (NEUTRAL) position. When beginning to drive, do not shift the selector lever from the “P” (PARK) or “N” (NEUTRAL) position while depressing the accelerator pedal. Doing so is dangerous because the vehicle will “jump” forward or backward.

NOTE

- To ensure proper transmission operation, stop at each detent position when shifting. After shifting, check the position in the multi-information display.
- If the brake pedal is not depressed and held, the shift-lock device activates to prevent the selector lever from being moved from the “P” (PARK) position.
- For a shift indicated by  in the illustration, depress the brake pedal before moving the selector lever. If you attempt to move the selector lever before depressing the brake pedal, the selector lever will be immovable.

When the selector lever cannot be shifted from the “P” (PARK) position

N00563101073

When the selector lever cannot be shifted from the “P” (PARK) position to another position while the brake pedal is pressed and held down with the ignition switch at the “ON” position, the battery may be flat or the shift-lock mechanism may be malfunctioning.

Immediately have your vehicle checked by an authorized Mitsubishi Motors dealer or a repair facility of your choice.

If you need to move the vehicle, shift the selector lever as follows.

1. Make sure the parking brake is fully applied.
2. Stop the engine if it is running.
3. Insert a screwdriver with a cloth over its tip into the notch (A) of the cover. Pry gently as shown to remove the cover.

5

Continuously variable transmission (CVT) (if so equipped)

5

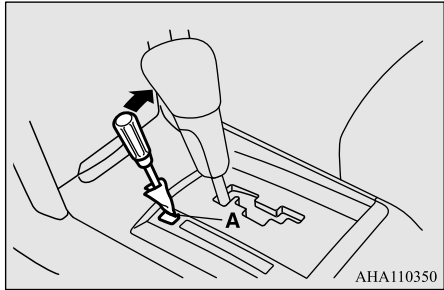

4. Depress the brake pedal with the right foot.
5. Turn the ignition switch to the “ACC” position.

NOTE

- For vehicles with the Free-hand Advanced Security Transmitter (F.A.S.T.-key), turn the ignition switch to the “ACC” position with the emergency key if the vehicle battery is flat.

6. Insert a screwdriver in the shift-lock release hole (B). Shift the selector lever to the “N” (NEUTRAL) position while pressing the screwdriver down.

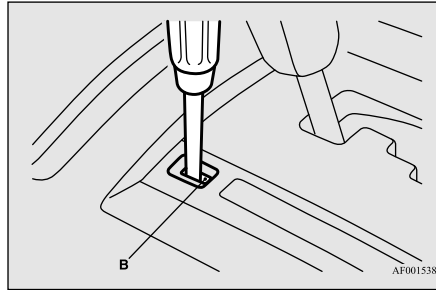

Selector lever position display

N00513900428

When the ignition switch is turned to the “ON” position, the selector lever position is shown on the multi-information display.

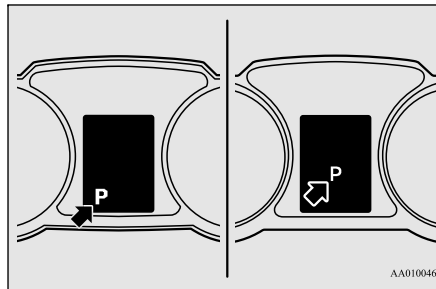

When the selector lever position display blinks

N00585900032

WARNING

- To avoid unintended vehicle movement, keep brake pedal applied with your right foot and do not depress the accelerator pedal, while the selector lever position display is blinking.

If the ambient temperature is low, the selector lever position display on the multi-information display may blink when the selector lever is placed in the “D” (DRIVE) or “R” (REVERSE) position immediately after the engine has been started. This indicates that the transmission requires warming up. While the display is blinking, the vehicle will not move, because the transmission keeps disengaging until the warm up is completed even if the selector lever is placed in the “D” or “R” position.

When the selector lever position display is blinking, perform the following procedure:

1. Depress the brake pedal with your right foot and place the selector lever in the “N” (NEUTRAL) position for several seconds.

Continuously variable transmission (CVT) (if so equipped)

- Keep depressing the brake pedal and then place the selector lever in the “D” (DRIVE) or “R” (REVERSE) position. If the selector lever position display stops blinking, the warm up is completed and the transmission will function normally.
- If the display is still blinking, repeat steps 1 and 2 above.

NOTE

- While the selector lever position display is blinking, a buzzer will sound intermittently.

Warning display

N00514000240

Type 1

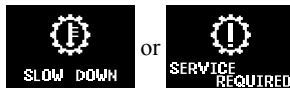

Type 2



When the warning display or the warning display appears on the information screen in the multi-information display while you are driving, there could be a malfunction in the CVT.

CAUTION

- If a malfunction occurs in the CVT while driving, the warning display or the warning display will appear on the information screen in the multi-information display. In this case, immediately park your vehicle in a safe place and follow these procedures:

[When warning display is showing]

The continuously variable transmission (CVT) fluid is overheating. The engine control may activate to lower the CVT fluid temperature, causing the engine revolutions and vehicle speed to decrease. In this case, take one of the following procedures:

- Slow down your vehicle.
- Stop your vehicle in a safe place, put the selector lever in the “P” (PARK) position, and open the engine hood with the engine running to allow the engine to cool down.

After a while, confirm that the warning display is no longer showing. It is safe to continue driving if the display is no longer showing. If the warning display remains or flashes frequently, have your vehicle inspected by an authorized Mitsubishi Motors dealer or a repair facility of your choice.

CAUTION

[When warning display is showing]

It may be that there is something unusual happening in the CVT, causing a safety device to activate. Have your vehicle inspected by an authorized Mitsubishi Motors dealer or a repair facility of your choice as soon as possible.

5

Selector lever positions

N00514201412

“P” PARK

This position locks the transmission to prevent the vehicle from moving. The engine can be started from the “PARK” position.

“R” REVERSE

Move the lever to this position only after the vehicle has come to a complete stop.

CAUTION

- Never shift into the “P” (PARK) or “R” (REVERSE) position while the vehicle is in motion. If the lever is shifted into the “P” (PARK) or “R” (REVERSE) position while the vehicle is in motion, the transmission may be damaged.

Continuously variable transmission (CVT) (if so equipped)

“N” NEUTRAL

At this position, the transmission is disengaged. It is the same as the neutral position on a manual transaxle and should be used when the vehicle is not moving for an extended length of time during driving, such as in a traffic jam.

5

! WARNING

- Never move the selector lever to the “N” (NEUTRAL) position while driving since you could accidentally slip it into the “P” (PARK) or “R”(REVERSE) position, damaging the transmission.
- To prevent the vehicle from rolling when stopped on a slope, the engine should be started in the “P” (PARK) position, not in “N” (NEUTRAL) position.
- To prevent rolling, always keep your foot on the brake pedal when the vehicle is in “N” (NEUTRAL) position, or when shifting into or out of “N” (NEUTRAL) position.

“D” DRIVE

This position is used for most city and highway driving. The transmission will automatically and continuously change its gear ratio depending on road and driving conditions.

5-62 Features and controls

! CAUTION

- To prevent transmission damage, never shift into the “D” (DRIVE) position from the “R” (REVERSE) position while the vehicle is in motion.

“L” LOW

This position is for driving up very steep hills and for engine braking at low speeds when driving down steep hills.

! WARNING

- This position can be used for maximum engine braking. Be very careful not to shift into “L” (LOW) suddenly. Sudden engine braking may cause the tires to skid. Select this position according to the road conditions and vehicle speed.

Sports mode (if so equipped)

N00514401472

While driving with the selector lever in the “D” (DRIVE), sports mode can be selected by pulling one of the sportronic steering wheel shifters toward you.

In sports mode, rapid shifting is possible simply by operating the sportronic steering wheel paddle shifter.

Unlike the manual transaxle, sports mode allows shifting with the accelerator pedal depressed.

📖 NOTE

- To return to “D” (DRIVE) operation, pull the sportronic steering wheel paddle shifter on the +(UP) side for longer than 2 seconds, or park the vehicle to change the selector lever position indicator to “D” (DRIVE) and return to “D” (DRIVE) operation.
- When the sportronic steering wheel paddle shifter is operated with the selector lever in the “L” (LOW) position, gear is not shifted because the selectable shift range is limited.

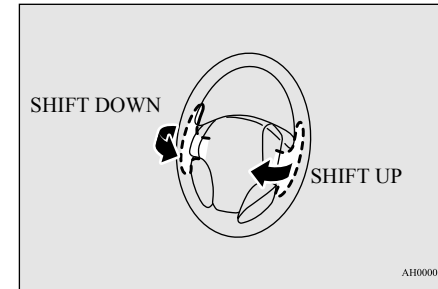

+ (SHIFT UP)

Transmission shifts up once by each operation.

AH0000663

Continuously variable transmission (CVT) (if so equipped)

- (SHIFT DOWN)

Transmission shifts down once by each operation.

CAUTION

- In sports mode, the driver must execute upward shifts in accordance with prevailing road conditions, taking care to keep the engine speed below the red zone.
- Repeated continuous operation of the sportronic steering wheel paddle shifter will continuously switch shift position.
- Shift ranges may not change when the lateral paddle shifters are operated at the same time.

NOTE

- The upward shift may be made automatically in sports mode when the engine revolutions rises and approaches the tachometer's red zone (the red-colored part of the tachometer dial).
- Shift ranges can only be selected in a forward direction from 1st to 6th. To reverse or park the vehicle, move the selector lever to the "R" (REVERSE) or "P" (PARK) position.

NOTE

- To maintain good running performance, the transmission may refuse to perform an upshift when the sportronic steering wheel paddle shifter is moved to the "+(SHIFT UP)" position at certain vehicle speeds. Also, to prevent over-revving of the engine, the transmission may refuse to perform a downshift when the sportronic steering wheel paddle shifter is moved to the "-(SHIFT DOWN)" position at certain vehicle speeds.
- Do not operate sportronic steering wheel paddle shifter violently. Excessive force could damage the sportronic steering wheel paddle shifter.

Sports mode display

N00538800170

In sports mode, the currently selected shift range is displayed on the information screen in the multi-information display.

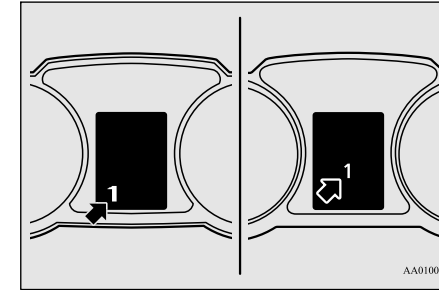

5

Operation of the CVT

N00514500333

CAUTION

- Before selecting a position with the engine running and the vehicle stationary, fully depress the brake pedal to prevent the vehicle from creeping. Do not release the brakes until you are ready to drive away. The vehicle will begin to move as soon as the CVT is engaged, especially when the engine speed is high (fast idle or air conditioning on).
- Depress the brake pedal with the right foot. Using the left foot could cause driver movement delay in case of an emergency.
- To prevent sudden acceleration, never run the engine at high rpms when shifting from the "P" (PARK) or "N" (NEUTRAL) position.

Continuously variable transmission (CVT) (if so equipped)

CAUTION

- Operating the accelerator pedal while the other foot is resting on the brake pedal will affect braking efficiency and may cause premature wear of brake pads.
 - Use the selector lever in the correct shift position in accordance with driving conditions.

Never coast downhill backward in the driving shift position { “D” (DRIVE), “L” (LOW) or sports mode} or coast forward in the “R” (REVERSE) position.

Engine stopping and increased brake pedal and steering effort could lead to an accident.
 - Do not rev the engine with the brake pedal pressed when the vehicle is stationary. This can damage the CVT.
- Also, when you depress the accelerator pedal while holding down the brake pedal with the selector lever in the “D” (DRIVE) position, the engine revolutions may not rise as high as when performing the same operation with the selector lever in the “N” (NEUTRAL) position.

Passing acceleration

N00514900063

To gain extra acceleration in “D” (DRIVE) position (when passing another vehicle) push the accelerator to the floor if it is safe to do so in traffic conditions. The CVT will automatically downshift.

NOTE

- In sports mode, downshifts do not take place when the accelerator is depressed all the way to the floor.

Waiting

N00515001097

For short waiting periods, such as at traffic lights, the vehicle can be left in selector lever position and held stationary with the service brake.

For longer waiting periods with the engine running, the selector lever should be placed in the “N” (NEUTRAL) position.

CAUTION

- To avoid transmission overheating, never try to keep your vehicle stationary on a hill by using the accelerator pedal. Always apply the parking brake and/or service brake.
- Unexpected acceleration may occur if the selector lever is in a position other than “P” (PARK) or “N” (NEUTRAL). Before driving off from a stop, make sure that the selector lever is in “D” (DRIVE) position.

Parking

N00515100062

To park the vehicle, first bring it to a complete stop, fully engage the parking brake, and then move the selector lever to the “P” (PARK) position.

If you are going to leave the vehicle unattended, always switch off the engine and carry the key.

NOTE

- On a slope, be sure to apply the parking brake before moving the selector lever to the “P” (PARK) position. If you move the selector lever to the “P” (PARK) position before applying the parking brake, it may be difficult to disengage the selector lever from the “P” (PARK) position when next you drive the vehicle, requiring application of a strong force to the selector lever to move from the “P” (PARK) position.

When the CVT makes no speed change

N00515301218

If the CVT does not shift while driving, or your vehicle does not pick up enough speed when starting on an uphill slope, there may be something unusual happening in the transmission, causing a safety device to activate. Have your vehicle checked at an authorized

Service brake

Mitsubishi Motors dealer or a repair facility of your choice as soon as possible.

1. If your vehicle has difficulty moving uphill, shift the selector lever into “L” (LOW) position or 2nd shift range of the sports mode.
This method might not work depending on the type of transmission malfunction.
2. Once the vehicle is moving on a level road, move the selector lever back to “D” (DRIVE) position.

When driving down a long or steep hill, use engine braking by downshifting.

WARNING



- Do not leave any objects near the brake pedal or let a floor mat slide under it; doing so could prevent the full pedal stroke that would be necessary in an emergency. Make sure that the pedal can be operated freely at all times. Make sure the floor mat is securely held in place.

If the power brake unit or either of the two brake hydraulic systems stops working properly, the rest of the brake system will still work, but the vehicle will not slow down as quickly.

You will know this has happened if you find you need to depress the brake pedal down further, or harder when slowing down or stopping, or if the brake warning light and the warning display in the multi-information display come on.

5

NOTE

- When the  warning display or the  warning display appears on the information screen in the multi-information display, there could be a malfunction in the CVT. Refer to “Continuously variable transmission (CVT): Warning display” on page 5-61.

CAUTION

- It is important not to drive the vehicle with your foot resting on the brake pedal when braking is not required. This practice can result in very high brake temperatures, premature pad and lining wear, and possible damage to the brakes.

WARNING

- Never coast downhill with the engine OFF. Keep the engine running whenever your vehicle is in motion. If you turn off the engine while driving, the power brake booster will stop working and your brakes will not work as well.
- If the power assist is lost or if either brake hydraulic system stops working properly, take your vehicle to an authorized Mitsubishi Motors dealer or a repair facility of your choice immediately.

Service brake

N00517500262

Brake pedal

Overuse of the brake can cause poor brake response and premature wear of the brake pads and linings.

Power brakes

N00517601446

Your vehicle is equipped with power brakes for more braking force with minimal brake pedal effort.

Your brakes are designed to operate at full capacity, even if the power assist is lost.

If the power assist is lost, the effort needed to press the brake pedal is greater.

If you should lose the power assist for some reason, the brakes will still work.

Brake pad wear alarm

N00532500087

The disc brakes have an alarm that makes a metallic squeal when the brake pads have worn down enough to need service. If you hear this sound, have the brake pads replaced

Brake assist system

at an authorized Mitsubishi Motors dealer or a repair facility of your choice.

WARNING

- Driving with worn brake pads will make it harder to stop, and can cause an accident.

5

Brake assist system

N00567300076

The brake assist system is a device assisting drivers who cannot depress the brake pedal firmly such as in emergency stop situations and provides greater braking force.

If the brake pedal is depressed suddenly, the brakes will be applied with more force than usual.

CAUTION

- The brake assist system is not a device designed to exercise braking force greater than its capacity. Make sure to always keep a sufficient distance between vehicles in front of you without relying too much on the brake assist system.

NOTE

- Once the brake assist system is operational, it maintains great braking force even if the brake pedal is lightly released. To stop its operation, completely remove your foot from the brake pedal.
- The brake assist system may become operational when the brake pedal is fully depressed even if it has not been depressed suddenly.
- When the brake assist system is in use while driving, you may feel as if the depressed brake pedal is soft, the pedal moves in small motions in conjunction with the operation noise, or the vehicle body and the steering wheel vibrate. This occurs when the brake assist system is operating normally and does not indicate faulty operation. Continue to depress the brake pedal.
- You may hear an operation noise when the brake pedal is suddenly or fully depressed while stationary. This does not indicate a malfunction and the brake assist system is operating normally.

Anti-lock braking system

N00517900282

The anti-lock braking system helps prevent the wheels from locking up when braking. This helps you keep control of your vehicle and its direction.

Driving hints

- When using the anti-lock brakes (sudden braking), steering is slightly different from normal driving conditions. Use the steering wheel carefully.
- Always keep a safe distance from the vehicle in front of you. Even if your vehicle is equipped with the anti-lock braking system, leave a greater braking distance when:
 - Driving on gravel or snow-covered roads.
 - Driving on uneven road surfaces.
- Operation of anti-lock braking system is not restricted to situations where brakes are applied suddenly. This system may also prevent the wheels from locking when you drive over manholes, steel roadwork plates, road markings, or any uneven road surface.
- When the anti-lock braking system is in use, you may feel the brake pedal vibrating and hear a unique sound. You may also feel as if the pedal resists being pressed.
In this situation, simply hold the brake pedal down firmly. Do not pump the brake, which will result in reduced braking performance.

Anti-lock braking system

⚠ CAUTION

- The anti-lock braking system cannot prevent accidents. It is your responsibility to take safety precautions and to drive carefully.
- To prevent failure of the anti-lock braking system, be sure all four wheels and tires are the same size and the same type.
- Never install a limited-slip differential as the anti-lock braking system may not function normally.
Please consult an authorized Mitsubishi Motors dealer.

📖 NOTE

- After your vehicle is driven a short distance after starting the engine, you will hear the sound coming from the engine compartment. These are the normal sounds the anti-lock braking system makes when performing a self-check. It does not indicate a malfunction.
- The anti-lock braking system can be used after the vehicle has reached a speed over approximately 6 mph (10 km/h). It stops working when the vehicle slows below approximately 3 mph (5 km/h).

Anti-lock braking system warning light/display

N00531600616

Warning light



Warning display type 1



Warning display type 2



If there is a malfunction in the system, the anti-lock braking system warning light will come on and the warning display will appear on the information screen in the multi-information display.

Under normal conditions, the anti-lock braking system warning light only comes on when the ignition switch is turned to the "ON" position and goes off a few seconds later.

⚠ CAUTION

- Any of the following warning light/display behavior indicates that the anti-lock braking system is not functioning and only the standard brake system is working. (The standard brake system will still work properly.) If this happens, take your vehicle to an authorized Mitsubishi Motors dealer or a repair facility of your choice as soon as possible.
- When the ignition switch is in the "ON" position, the warning light does not come on or it remains on and does not go off
- The warning light comes on while driving
- The warning display appears while driving

5

If the warning light/display comes on while driving

N00531701627

If only the anti-lock braking system warning light/display comes on

- Avoid hard braking and high-speed driving. Stop the vehicle in a safe place. Test the system by restarting the engine and driving at a speed of about 12 mph (20 km/h) or higher. If the warning light/display then remain off during driving, there is no problem.

Anti-lock braking system

However, if the warning light/display do not disappear, or if they come on again when the vehicle is driven, have the vehicle checked by an authorized Mitsubishi Motors dealer or repair facility of your choice as soon as possible.

5 If the anti-lock braking system warning light/display and brake warning light/display come on at the same time

Warning light

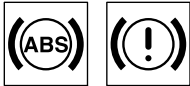

Warning display type 1



Warning display type 2



The anti-lock braking system and brake force distribution function may not work, so hard braking could make the vehicle unstable.

Avoid hard braking and high-speed driving. Stop the vehicle in a safe place and contact an authorized Mitsubishi Motors dealer or repair facility of your choice.

NOTE

- The anti-lock braking system warning light and brake warning light illuminate at the same time and the warning displays appear alternately on the information screen in the multi-information display.

After driving on icy roads

N00529200051

After driving on snow or icy roads, remove any snow and ice which may have been left around the wheels. On vehicles that have an

anti-lock braking system, be careful not to damage the wheel speed sensors (A) or the cables located at each wheel.

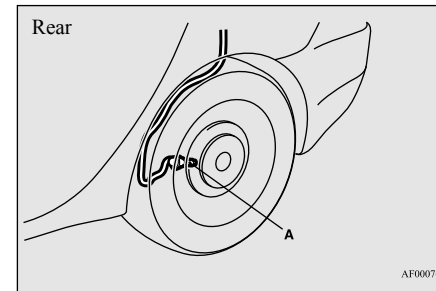
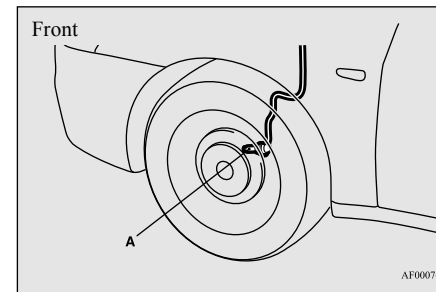

Electric power steering system (EPS)

N00568401097

The power steering system operates while the engine is running. It helps reduce the effort needed to turn the steering wheel.

The power steering system has mechanical steering capability in case the power assist is lost. If the power assist is lost for some reason, you will still be able to steer your vehicle, but you will notice it takes much more effort to steer. If this happens, have your vehicle inspected at an authorized Mitsubishi Motors dealer or a repair facility of your choice.

WARNING

- Do not stop the engine while the vehicle is moving. Stopping the engine would make the steering wheel extremely hard to turn, possibly resulting in an accident.

NOTE

- During repeated full-lock turning of the steering wheel (for example, while you are manoeuvring the vehicle into a parking space), a protection function may be activated to prevent overheating of the power steering system. This function will make the steering wheel gradually harder to turn. In this event, limit your turning of the steering wheel for a while. When the system has cooled down, the steering effort will return to normal.
- If you turn the steering wheel while the vehicle is stationary with the headlights on, the headlights may become dim. This behavior is not abnormal. The headlights will return to their original brightness after a short while.

Electronic power steering system warning display

Type 1



Electric power steering system (EPS)

Type 2



If there is a malfunction in the system, the warning display will appear on the information screen in the multi-information display.

5

CAUTION

- If the warning display appears while the engine is running, have the vehicle inspected by an authorized Mitsubishi Motors dealer or a repair facility of your choice as soon as possible. It may become harder to turn the steering wheel.

Active stability control (ASC)

N0055910091

The active stability control (ASC) takes overall control of the anti-lock braking system, traction control function and skid control function to help maintain the vehicle's control and traction. Please read this section in conjunction with the page on the anti-lock braking system, traction control function and skid control function.

Active stability control (ASC)

Anti-lock braking system → P.5-66
 Traction control function → P.5-70
 Skid control function → P.5-70

5

CAUTION

- Do not over-rely on the ASC. Even the ASC cannot prevent the natural laws of physics from acting on the vehicle. This system, like any other system, has limits and cannot help you to maintain traction and control of the vehicle in all circumstances. Reckless driving can lead to accidents. It is the driver's responsibility to drive carefully, This means taking into account the traffic, road and environmental conditions.
- Be sure to use the same specified type and size of tire on all four wheels. Otherwise, the ASC may not work properly.
- Do not install any aftermarket limited-slip differential (LSD) on your vehicle. The ASC may stop functioning properly.

NOTE

- An operation noise may be emitted from the engine compartment in the following situations. The sound is associated with checking the operations of the ASC. At this time, you may feel a shock from the brake pedal if you depress it. These do not indicate a malfunction.
- When the ignition switch is set to the "ON" position.

NOTE

- When the vehicle is driven for a while after the engine is turned on.
- When the ASC is activated, you may feel a vibration in the vehicle body or hear a whining sound from the engine compartment. This indicates that the system is operating normally. It does not indicate a malfunction.
- When the anti-lock braking system warning light is illuminated, the ASC is not active.

Traction control function

N00559200047

On slippery surfaces, the traction control function prevents the drive wheels from spinning excessive, thus helping the vehicle to start moving from a stopped condition. It also provides sufficient driving force and steering performance as the vehicle turns while pressing the acceleration pedal.

CAUTION

- When driving a vehicle on a snowy or icy road, be sure to install snow tires and drive the vehicle at moderate speeds.

Skid control function

N00546800023

The skid control function is designed to help the driver maintain control of the vehicle on

slippery roads or during rapid steering maneuvers. It works by controlling the engine output and the brake on each wheel.



NOTE

- The skid control function operates at speeds of about 9 mph (15 km/h) or higher.

"ASC OFF" switch

N00559400212

The ASC is automatically activated when the ignition switch is turned to the "ON" position. You can deactivate the system by pressing down the "ASC OFF" switch for 3 seconds or longer.

When the ASC is deactivated, the  display/indicator will turn on. To reactivate the ASC, momentarily press the "ASC OFF" switch ; the  display/indicator is turned off.

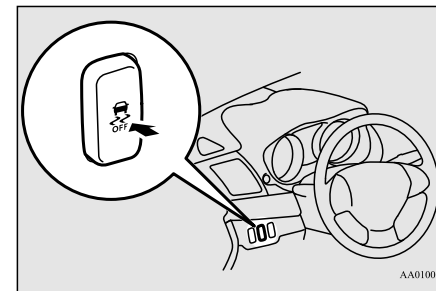

Active stability control (ASC)

CAUTION

- For safety reasons, the “ASC OFF” switch should be operated when your vehicle is stopped.
- Be sure to keep the ASC on while driving in normal circumstances.

NOTE

- Using the “ASC OFF” switch turns off both the skid control function and the traction control function.
- When moving out of mud, sand or fresh snow, pressing the accelerator pedal may not allow the engine speed to increase. In such situations, temporarily turning off ASC with the “ASC OFF” switch will make it easier to move out your vehicle.
- If you continue to press the “ASC OFF” switch after the ASC is turned off, the “mistaken operation protection function” will activate and the ASC will turn back on.

ASC operation display or ASC OFF display

N00546500105



ASC operation display/ASC indicator

The display/indicator will blink when the ASC is operating.





ASC OFF display/ASC OFF indicator

This display/incicator will turn on when the ASC is turned off with the “ASC OFF” switch.



NOTE

- The combination of items shown on the display varies depending on the vehicle model.

CAUTION

- When  display/indicator blinks, ASC is operating, which means that the road is slippery or that your vehicle’s wheels are beginning to slip. If this happens, drive slower.
- If the temperature in the braking system continues to increase due to continuous brake control on a slippery road surface, the  display/indicator will blink. To prevent the brake system from overheating, the brake control of the traction control function will be temporarily suspended. The engine control of the traction control function and normal brake operation will not be affected. Park your vehicle in a safe place. When the temperature in the braking system has come down, the  display/indicator will be turned off and the traction control function will start operating again.

NOTE

- The  display/indicator may come on when you start the engine. This means that the battery voltage momentarily dropped when the engine was started. It does not indicate a malfunction, provided that the display goes out immediately.
- When a spare tire has been put on your vehicle, the gripping ability of the tire will be lower, making it more likely that the  display/indicator will blink.

5

ASC warning display

N00546600106

If an abnormal condition occurs in the system, the following display/indicator will turn on.



ASC indicator



ASC OFF display/ASC OFF indicator

Warning display type 1



Cruise control

Warning display type 2



5

NOTE

- The combination of items shown on the display varies depending on the vehicle model.

CAUTION

- The system may be malfunctioning. Park your vehicle in a safe place and stop the engine. Restart the engine and check whether the display/indicator goes out. If they go out, there is no abnormal condition. If they do not go out or if they turn on frequently, it is not necessary to stop the vehicle immediately, but you should have your vehicle inspected by an authorized Mitsubishi Motors dealer or a repair facility of your choice as soon as possible.

Towing

N00546300057

CAUTION

- When towing the vehicle with only the front wheels or only the rear wheels raised off the ground, do not place the ignition switch in the “ON” position. Placing the ignition switch in the “ON” position could cause the ASC to operate, resulting in an accident. Note that the correct towing method depends on the transmission type and the vehicle’s drive configuration. For details, refer to “Towing” on page 8-11.

Cruise control

N00518301613

Cruise control is an automatic speed control system that keeps a set speed. It can be activated at speeds from about 25 mph (40 km/h). Cruise control does not work at speeds below about 25 mph (40 km/h).

CAUTION

- When you do not wish to drive at a set speed, turn off the cruise control for safety.
- Do not use cruise control when driving conditions will not allow you to stay at the same speed, such as in heavy traffic or on roads that are winding, icy, snow-covered, wet, slippery, on a steep downhill slope.

CAUTION

- On vehicles equipped with manual transaxle, do not move the gearshift lever to the “N” (Neutral) position while driving at a set speed without depressing the clutch pedal. The engine will run too fast and might be damaged.

NOTE

- Cruise control may not be able to keep your speed on uphill or downhill.
- Your speed may decrease on a steep uphill. You may use the accelerator pedal if you want to stay at your set speed.
- Your speed may increase to more than the set speed on a steep downhill. You have to use the brake to control your speed. As a result, the set speed driving is deactivated.

Cruise control switches

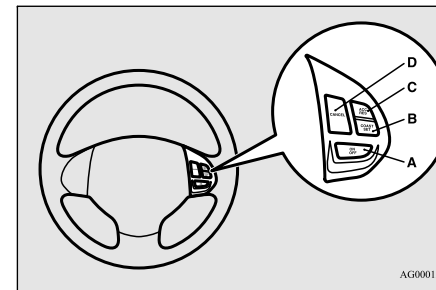

AG0001292

Cruise control

A- "ON OFF" switch

Used to turn on and off the cruise control.

B- "COAST SET" switch

Used to reduce the set speed and to set the desired speed.

C- "ACC RES" switch

Used to increase the set speed and to return to the original set speed.

D- "CANCEL" switch

Used to deactivate the set speed driving.

NOTE

- When operating the cruise control switches, press the cruise control switches correctly. The set speed driving may be deactivated automatically if two or more switches of the cruise control are pressed at the same time.

To activate

N00518401438

1. With the ignition switch in the "ON" position, press the "ON OFF" switch (A) to turn on the cruise control. The "CRUISE" indicator light in the meter cluster will come on.

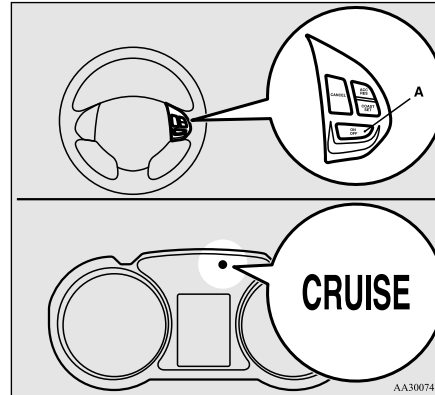

NOTE

- If the cruise control is on when the ignition switch is turned to "LOCK" or "ACC" position, cruise control will turn on automatically and the "CRUISE" control indicator will illuminate the next time you start the engine.

NOTE

- If the battery voltage is insufficient, the memory data for the cruise control may be erased. As a result, the "CRUISE" indicator light may not come on when you restart the engine. If this happens, press the "ON OFF" switch once again to turn on the cruise control.

2. Accelerate or decelerate to your desired speed, then press and release the "COAST SET" switch (B) when the "CRUISE" indicator light is illuminated. The vehicle will then maintain the desired speed.

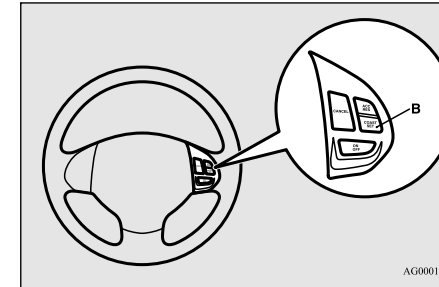

NOTE

- When you release the "COAST SET" switch, the vehicle speed will be set.

5

Cruise control

To increase the set speed

N00518501370

There are 2 ways to increase the set speed.

“ACC RES” switch

- 5** Press and hold the “ACC RES” switch (C) while driving at the set speed, and your speed will then gradually increase. When you reach your desired speed, release the switch. Your new cruising speed is now set.

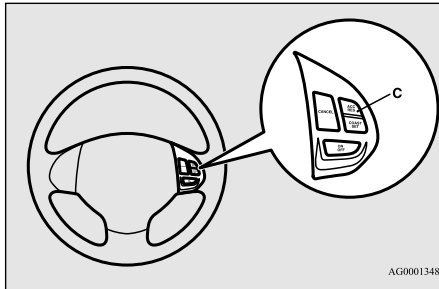

To increase your speed in small amounts, press the “ACC RES” switch for less than about 1 second and release it. Each time you press the “ACC RES” switch, your vehicle will go about 1 mph (1.6 km/h) faster.

Accelerator pedal

While driving at the set speed, use the accelerator pedal to reach your desired speed and then press the “COAST SET” switch (B) and release the switch momentarily to set a new desired cruising speed.

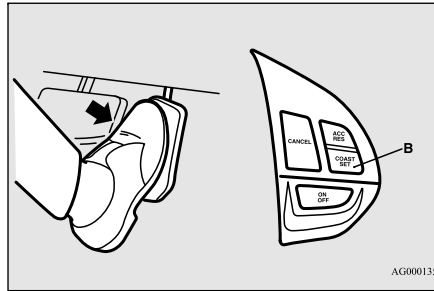

To decrease the set speed

N00518601300

There are 2 ways to decrease the set speed.

“COAST SET” switch

Press and hold the “COAST SET” switch (B) while driving at the set speed, and your speed will slow down gradually.

When you reach your desired speed, release the switch. Your new cruising speed is now set.

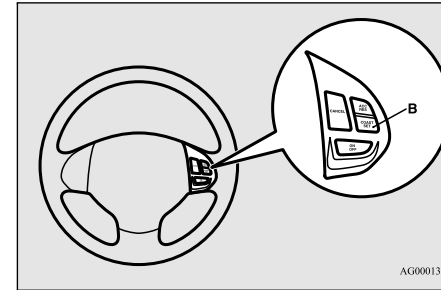

To slow down your speed in small amounts, press the “COAST SET” switch for less than about 1 second and release it.

Each time you press the “COAST SET” switch, your vehicle will slow down by about 1 mph (1.6 km/h).

Brake pedal

While driving at the set speed, use the brake pedal, which disengages the cruise control, then press the “COAST SET” switch (B) and release the switch momentarily to set a new desired cruising speed.

Cruise control

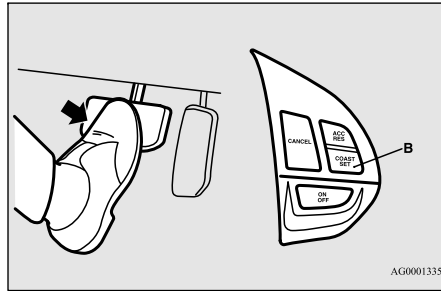

AG0001335

To temporarily increase or decrease the speed

N00541701082

To temporarily increase the speed

Depress the accelerator pedal as you would normally. When you release the pedal, you will return to your set speed.

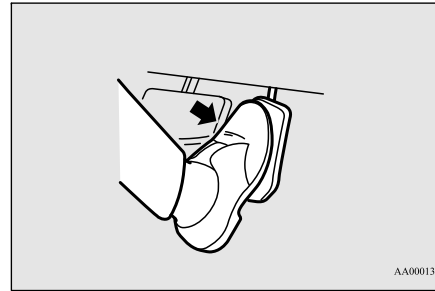

AA0001395

To temporarily decrease the speed

Depress the brake pedal to decrease the speed. To return to the previously set speed, press the "ACC RES" switch (C). Refer to "To resume the set speed" on page 5-76.

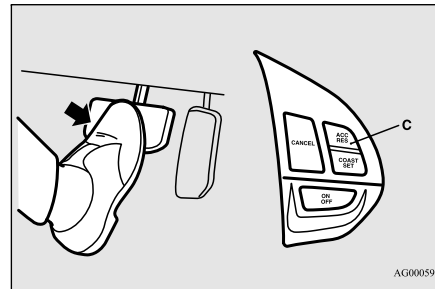

AG0005984

To deactivate

N00518801605

The set speed driving can be deactivated as follows:

- Press the "ON OFF" switch (A). (Cruise control will be turned off.)
- Press the "CANCEL" switch (D).
- Depress the brake pedal.

5

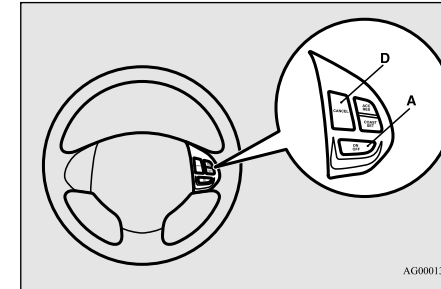

AG0001364

The set speed driving is deactivated automatically in any of the following ways.

- When you depress the clutch pedal (on vehicles equipped with manual transaxle).
- When your speed slows to about 10 mph (15 km/h) or more below the set speed because of a hill, etc.
- When your speed slows to about 25 mph (40 km/h) or less.

Tire pressure monitoring system

- When the active stability control (ASC) starts operating.
Refer to “Active stability control (ASC)” on page 5-69.

WARNING

- **On vehicles equipped with continuously variable transmission (CVT), although the set speed driving will be deactivated when shifting to the “N” (NEUTRAL) position, never move the selector lever to the “N” (NEUTRAL) position while driving. You would have no engine braking and could cause a serious accident.**

5

Also, the set speed driving may be deactivated as follow:

- When the engine speed rises and approaches the tachometer’s red zone (the red-colored part of the tachometer dial).

CAUTION

- When the set speed driving is deactivated automatically in any situation other than those listed above, there may be a system malfunction.
Press the “ON OFF” switch to turn off the cruise control and have your vehicle inspected by an authorized Mitsubishi Motors dealer or a repair facility of your choice.

To resume the set speed

N00518901332

If the set speed driving is deactivated by the condition described in “To deactivate” on page 5-75, you can resume the previously set speed by pressing the “ACC RES” switch (C) while driving at a speed of about 25 mph (40 km/h) or higher.

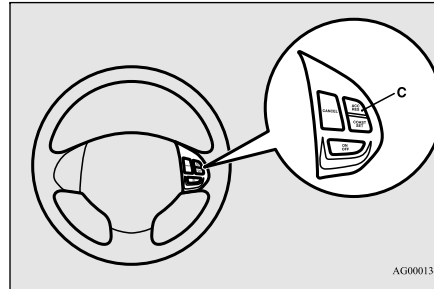

AG0001348

Under either of the following conditions, however, using the switch does not allow you to resume the previously set speed. In these situations, repeat the speed setting procedure:

- The “ON OFF” switch is pressed.
- The ignition switch is turned OFF.
- “CRUISE” indicator light is turned OFF.

Tire pressure monitoring system

N00530201582

The tire pressure monitoring system uses tire inflation pressure sensors (A) on the wheels to monitor the tire inflation pressures. The system only indicates when a tire is significantly under-inflated.

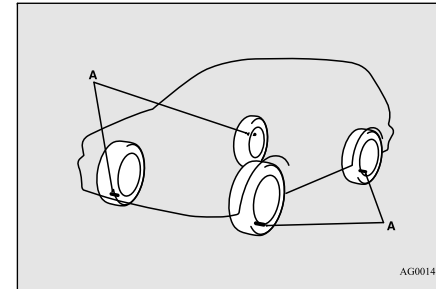

AG0014544

WARNING

- **The spare wheel does not have a tire inflation pressure sensor. When the spare tire is used, the tire pressure monitoring system will not work properly. See an authorized Mitsubishi Motors dealer as soon as possible to replace or repair the original tire.**

Tire pressure monitoring system

NOTE

- The tire pressure monitoring system is not a substitute for regularly checking tire inflation pressures.
Be sure to check the tire inflation pressures as described in “Tires” on page 9-13.
- The tire inflation pressure sensor (B) is installed in the illustrated location.
Replace grommet and washer (C) with a new one when the tire is replaced.
For details, please contact your authorized Mitsubishi Motors dealer.

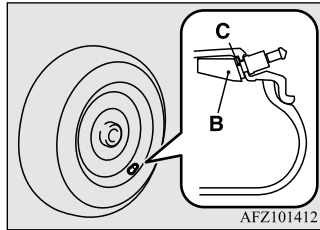

Tire pressure monitoring system warning light/display

N00532700122



When the ignition switch is turned to the “ON” position, the tire pressure monitoring

system warning light normally illuminates and goes off a few seconds later.

If one or more of the vehicle tires (except for the spare tire) is significantly under-inflated, the warning light will remain illuminated while the ignition switch is in the “ON” position.

Refer to “If the warning light/display illuminates while driving” on page 5-78 and take the necessary measures.

NOTE

- In addition, the warning display is displayed on the information screen in the multi-information display.

Type 1



Type 2



CAUTION

- If the tire pressure monitoring system warning light does not illuminate when the ignition switch is turned to the “ON” position, it means that the tire pressure monitoring system is not working properly. Have the system inspected by an authorized Mitsubishi Motors dealer.
In such situations, a malfunctioning of the system may be preventing the monitoring of the tire pressure. Avoid sudden braking, sharp turning and high-speed driving.
- If a malfunction is detected in the tire pressure monitoring system, the tire pressure monitoring system warning light will blink for approximately 1 minute and then remain continuously illuminated. The warning light will issue further warnings each time the engine is restarted as long as the malfunction exists.
Check to see whether the warning light goes off after few minutes driving.
If it then goes off during driving, there is no problem.
However, if the warning light does not go off, or if it blinks again when the engine is restarted, have the vehicle inspected by an authorized Mitsubishi Motors dealer.
In such situations, a malfunctioning of the system may be preventing the monitoring of the tire pressure. For safety reasons, when the warning light appears while driving, avoid sudden braking, sharp turning and high-speed driving.

5

Tire pressure monitoring system

NOTE

- In addition, the warning display is displayed on the information screen in the multi-information display.

Type 1



Type 2



Each tire, including the spare (if provided), should be checked monthly when cold and inflated to the inflation pressure recommended by the vehicle manufacturer on the vehicle placard or tire inflation pressure label. (If your vehicle has tires of a different size than the size indicated on the vehicle placard or tire inflation pressure label, you should determine the proper tire inflation pressure for those tires.)

As an added safety feature, your vehicle has been equipped with a tire pressure monitoring system (TPMS) that illuminates a low tire pressure telltale when one or more of your tires is significantly under-inflated.

Accordingly, when the low tire pressure telltale illuminates, you should stop and check your tires as soon as possible, and inflate them to the proper pressure. Driving on a significantly under-inflated tire causes the tire to overheat and can lead to tire failure.

Under-inflation also reduces fuel efficiency and tire tread life, and may affect the vehicle's handling and stopping ability. Please note that the TPMS is not a substitute for proper tire maintenance, and it is the driver's responsibility to maintain correct tire pressure, even if under-inflation has not reached the level to trigger illumination of the TPMS low tire pressure telltale.

Your vehicle has also been equipped with a TPMS malfunction indicator to indicate when the system is not operating properly. The TPMS malfunction indicator is combined with the low tire pressure telltale.

When the system detects a malfunction, the telltale will flash for approximately one minute and then remain continuously illuminated. This sequence will continue upon subsequent vehicle start-ups as long as the malfunction exists.

When the malfunction indicator is illuminated, the system may not be able to detect or signal low tire pressure as intended.

TPMS malfunctions may occur for a variety of reasons, including the installation of replacement or alternate tires or wheels on the

vehicle that prevent the TPMS from functioning properly. Always check the TPMS malfunction telltale after replacing one or more tires or wheels on your vehicle to ensure that the replacement or alternate tires and wheels allow the TPMS to continue to function properly.

If the warning light/display illuminates while driving

N00532800439

1. If the tire pressure monitoring system warning light illuminates, avoid hard braking, sharp steering maneuvers and high speeds. You should stop and adjust the tires to the proper inflation pressure as soon as possible. Adjust the spare tire at the same time. Refer to "Tires" on page 9-13.

NOTE

- In addition, the warning display is displayed on the information screen in the multi-information display.
- When inspecting or adjusting the tire pressure, do not apply excessive force to the valve stem to avoid breakage.

Tire pressure monitoring system

NOTE

- After inspecting or adjusting the tire pressure, always reinstall the valve cap on the valve stem.
Without the valve cap, dirt or moisture could get into the valve, resulting in damage to the tire inflation pressure sensor.
- Do not use metal valve caps, which may cause a metal reaction, resulting in corrosion and damage of the tire inflation pressure sensors.
- Once adjustments have been made, the warning light will go off after a few minutes of driving.

2. If the tire pressure monitoring system warning light remains illuminated after you have been driving for about 20 minutes after you adjust the tire inflation pressure, one or more of the tires may have a puncture. Inspect the tire and if it has a puncture, have it repaired by an authorized Mitsubishi Motors dealer as soon as possible.

WARNING

- **If the warning light/display illuminates while you are driving, avoid hard braking, sharp steering maneuvers and high speeds. Driving with an under-inflated tire adversely affects vehicle performance and can result in an accident.**

CAUTION

- If a tire has a puncture, replace that tire with the spare tire. Driving on a punctured tire could lead to an accident.
- The warning light/display may not illuminate immediately in the event of a tire blowout or rapid leak.

NOTE

- To avoid the risk of damage to the tire inflation pressure sensors, have any punctured tire repaired by an authorized Mitsubishi Motors dealer. If the tire repair is not done by an authorized Mitsubishi Motors dealer, it is not covered by your warranty.
- Do not use an aerosol puncture-repair product on any tire. Such a spray could damage the tire inflation pressure sensors. Have any puncture repaired by an authorized Mitsubishi Motors dealer.

The tire pressure monitoring system may not work normally in the following circumstances:

- A wireless facility or device using the same frequency is near the vehicle.
- Snow or ice is stuck inside the fenders and/or on the wheels.
- The tire inflation pressure sensor's battery is dead.

- Wheels other than Mitsubishi genuine wheels are being used.
- Wheels that are not fitted with tire inflation pressure sensors are being used.
- Wheels whose ID codes are not memorized by the vehicle are used.
- Compact spare tire is fitted on a road wheel.
- A window tint that affects the radio wave signals is installed.

5

NOTE

- Tire inflation pressures vary with the ambient temperature. If the vehicle is subjected to large variations in ambient temperature, the tire inflation pressures may be under-inflated (causing the warning light/display to come on) when the ambient temperature is relatively low. If the warning light/display comes on, adjust the tire inflation pressure.

Whenever the tires and wheels are replaced with new ones

N00532900179

If new wheels with new tire inflation pressure sensors are installed, their ID codes must be programmed into the tire pressure monitoring system. Have tire and wheel replacement performed by an authorized Mitsubishi Motors dealer to avoid the risk of damaging the tire inflation pressure sensors. If the wheel

Features and controls 5-79

Rear-view camera (if so equipped)

replacement is not done by an authorized Mitsubishi Motors dealer, it is not covered by your warranty.

CAUTION

- The use of non-genuine wheels will prevent the proper fit of the tire inflation pressure sensors, resulting in air leakage or damage to the sensors.

5

General information

N00533001259

Your tire pressure monitoring system operates on a radio frequency subject to Federal Communications Commission (FCC) Rules (For vehicles sold in U.S.A.) and Industry Canada Rules (For vehicles sold in Canada). This device complies with Part 15 of FCC Rules and Industry Canada licence-exempt RSS standard(s).

Operation is subject to the following two conditions.

- This device may not cause harmful interference.
- This device must accept any interference received, including interference that may cause undesired operation.

CAUTION

- Changes or modifications not expressly approved by the manufacturer for compliance could void the user's authority to operate the equipment.

Rear-view camera (if so equipped)

N00546201226

When the gearshift lever or the selector lever is in the "R" (REVERSE) position with the ignition switch in the "ON" position, the rear-view image will be displayed on the screen of the DISPLAY AUDIO in the center panel. When the gearshift lever or the selector lever is shifted out of the "R" (REVERSE) position, the rear-view image will go off.

WARNING

- **Never rely solely on the rear-view camera to clear the area behind your vehicle. Always check visually behind and all around your vehicle for persons, animals, obstructions or other vehicles. Failure to do so can result in vehicle damage, serious injury or death.**
- **The rear-view camera is an aid system for backing up, but it is not a substitute for your visual confirmation.**

WARNING

- **The view on the screen is limited, and objects outside the view, such as under the bumper or around either corner of the bumper end, cannot be seen on the screen.**

Location of rear-view camera

The rear-view camera (A) is in the rear hatch, at the left side of the rear hatch handle.

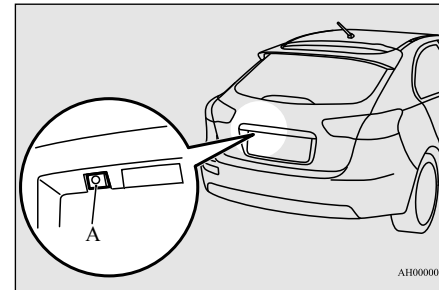

CAUTION

- If the camera lens gets dirty, a clear image cannot be obtained. As necessary, rinse the lens with clean water and gently wipe with a clean, soft cloth.
- To avoid damaging the camera;
 - Do not rub the cover excessively or polish it by using an abrasive compound.
 - Do not disassemble the camera.

CAUTION

- Do not splash hot water directly on the lens.
- Do not spray the camera and its surroundings with high-pressure water.
- Make sure that the rear hatch is securely closed when backing up.

Reference lines on the screen

Reference lines and upper surface of the rear bumper (A) are displayed on the screen.

- Red line (B) indicates approximately 20 inches (50 cm) behind the rear bumper.
- Two Green lines (C) indicate approximately 8 inches (20 cm) outside of the vehicle body.
- Short transverse lines (1 to 3) indicate distance from the rear bumper.

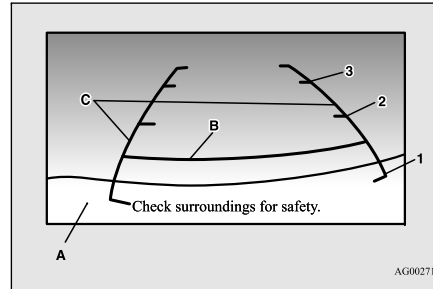

- 1: Approximately at the rear edge of the rear bumper
- 2: Approximately 39 inches (100 cm)
- 3: Approximately 79 inches (200 cm)

CAUTION

- The rear-view camera uses a wide-angle lens. As a result, images and distances shown on the screen are not exact.
- Actual distance may be different from distance indicated by the lines on the screen, depending on the loading condition of the vehicle and road surface condition. The reference lines for distance and vehicle width are based on a level, flat road surface. In the following cases, objects shown on the screen will appear to be farther off than they actually are.
 - When the rear of the vehicle is weighed down with the weight of passengers and luggage in the vehicle. (Case 1)

Rear-view camera (if so equipped)

CAUTION

- When there is an upward slope at the back. (Case 2)

Case 1

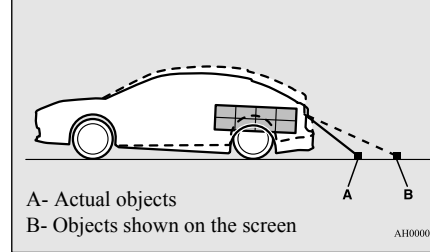

5

Case 2

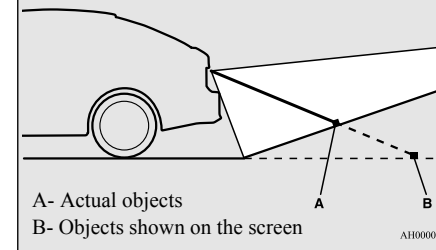

Instrument cluster

CAUTION

- The reference lines for distance and vehicle width are intended to indicate the distance to a flat object such as a level, flat road surface. They may not indicate correct distance depending on the shape of an obstacle. For example, when there is an object behind the vehicle that has upper sections projecting in the direction of the vehicle, the reference lines on the screen will indicate that point A is the farthest point and point B is the closest point to the vehicle. In reality, point A and B are actually the same distance from the vehicle, and point C is farther off than point A and B.

5

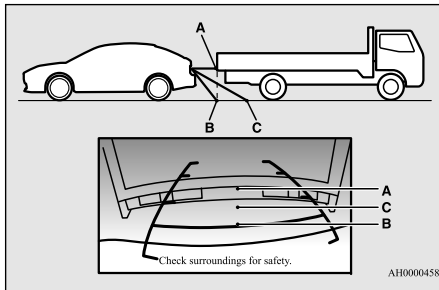

NOTE

- Under certain circumstances, it may become difficult to see an image on the screen, even when the system is functioning correctly.
- In a dark area, such as at night.

5-82 Features and controls

NOTE

- When water drops or condensation are on the lens.
- When sun light or headlights shine directly into the lens.

Instrument cluster

N0051900362

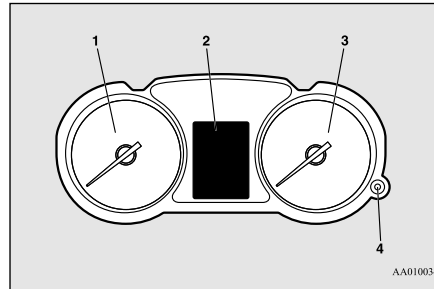

- Tachometer →P.5-82
- Multi-information display →P.5-84
Information screen display list →P.5-105
- Speedometer →P.5-82
- Rheostat meter illumination button →P.5-83

Speedometer

N00519101285

The speedometer shows the vehicle speed in kilometers per hour (km/h).

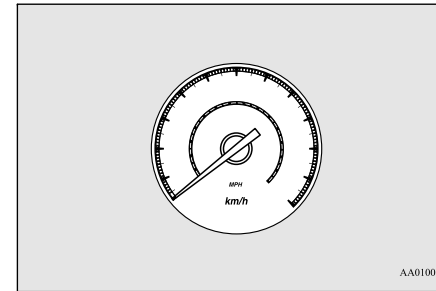

AA0100591

Tachometer

N00519201316

The tachometer shows engine revolutions per minute. This allows the driver to determine the most efficient shift position (manual transaxle), selector position {continuously variable transmission (CVT)} and engine speed combinations. This gauge also assists in evaluating engine performance.

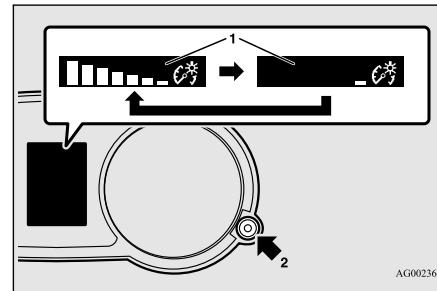
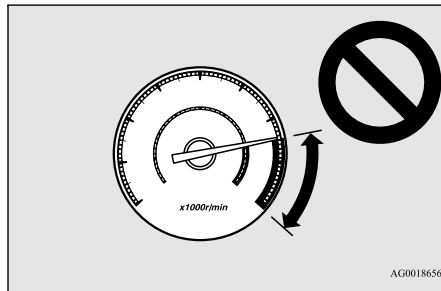

- 1- Brightness display
- 2- Rheostat illumination button

CAUTION

- The red zone indicates an engine speed beyond the range of safe operation.
- Select the correct shift position (manual transaxle) or selector position (CVT) to control the engine speed so that the tachometer indicator does not enter the red zone.

NOTE

- You can adjust to 8 different levels respectively for when the tail lights are illuminated and when they are not.
- The brightness level of the instruments is stored in memory when the ignition switch is turned off.
- If you press and hold the button for longer than about 1 second when the parking lights are illuminated, the brightness level changes to the maximum level. Pressing and holding the button for longer than about 1 second again returns the brightness level to the previous level.

Rheostat meter illumination button

N00554901222

Each time you press this button, there is a sound and the brightness of the instruments changes.

Multi-information display

Multi-information display

N0055001363

The multi-information display displays warnings, the odometer, trip odometer, service reminder, engine coolant temperature, fuel remaining, outside temperature, gearshift lever position, selector lever position, average and momentary fuel consumption, driving range, average speed, instrument brightness, etc.

It is also possible to change elements such as the language and units used on the multi-information display.

5

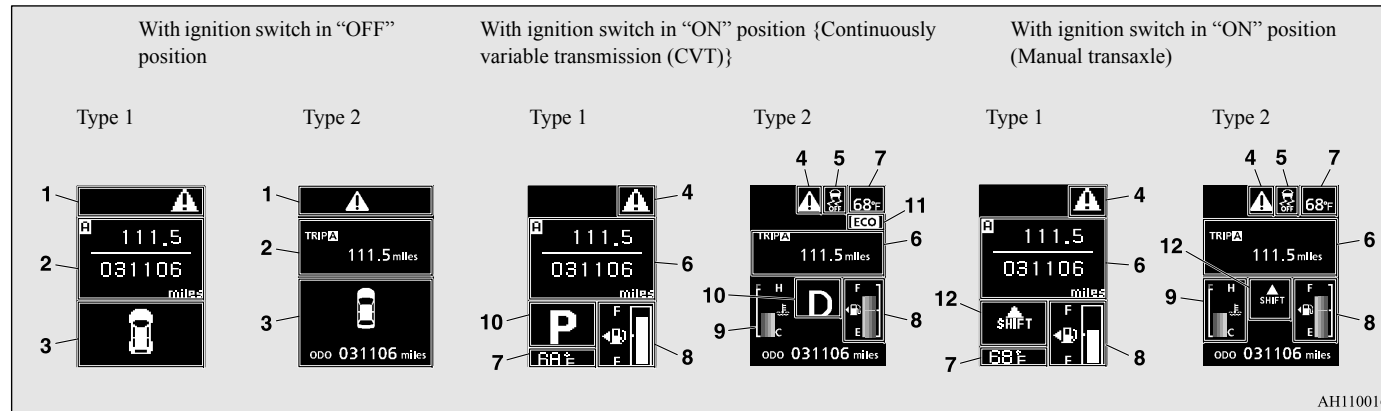

AH1100166

- 1- Warning display screen (With ignition switch in the “OFF” position) →P.5-85
- 2- Information screen (With ignition switch in the “OFF” position) →P.5-86
Interrupt display screen (With ignition switch in the “OFF” position) →P.5-87

- 3- Door ajar warning display screen (With ignition switch in the “OFF” position) →P.5-88
- 4- Warning display screen (With ignition switch in the “ON” position) →P.5-89
- 5- Active stability control (ASC) OFF display screen (if so equipped) →P.5-89

- 6- Information screen (With ignition switch in the “ON” position) →P.5-90
Interrupt display screen (With ignition switch in the “ON” position) →P.5-93
- 7- Outside temperature display screen →P.5-93
- 8- Fuel remaining display screen →P.5-94
- 9- Engine coolant temperature display (if so equipped) →P.5-90

Multi-information display

- 10- Selector lever position display screen (CVT) →P.5-60
- 11- ECO mode indicator (if so equipped) →P.5-94
- 12- Gearshift indicator display screen (if so equipped) →P.5-57

NOTE

- The fuel units, temperature units, display language, and other settings can be changed. Refer to “Changing the function settings (With ignition switch in the “ON” position)” on page 5-96.
- The display screen is different depending on whether the ignition switch in the “OFF” or “ON” position.
Refer to “Information screen (With ignition switch in the “OFF” position)” on page 5-86.
Refer to “Warning display list (With ignition switch in the “OFF” position)” on page 5-106.
Refer to “Information screen (With ignition switch turned from “OFF” to “ON” position)” on page 5-88.
Refer to “Information screen (With ignition switch in the “ON” position)” on page 5-90.
Refer to “Warning display list (With ignition switch in the “ON” position)” on page 5-109.

Multi-information meter switch

N00555101191

The multi-information meter switch is a button marked “INFO” on the left side of the dash.

Each time the multi-information meter switch is operated, a sound is emitted and the multi-information display changes between information such as warnings, service reminder, average and momentary fuel consumption, driving range and average speed.

It is also possible to change elements such as the language and units used on the multi-information display by operating the multi-information meter switch.

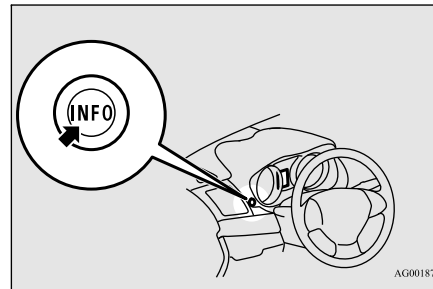
**Warning display screen (With ignition switch in the “OFF” position)**

N00555200212

If you press the multi-information meter switch and return from the warning display screen to the previous screen, the **A** warning is displayed.

Refer to “Returning to the display screen from before the warning display” on page 5-87.

This mark is also displayed if there is another warning other than the one displayed. When the cause of the warning display is eliminated, the **A** warning goes out automatically.

5**NOTE**

- When the **A** warning is displayed, the warning display screen can be redisplayed on the information screen.
Refer to “Information screen (With ignition switch in the “OFF” position)” on page 5-86.
Refer to “Information screen (With ignition switch in the “ON” position)” on page 5-90.

Multi-information display

Information screen (With ignition switch in the “OFF” position)

N0055300154

Each time you lightly press the multi-information meter switch, the display screen changes in the following order.

5

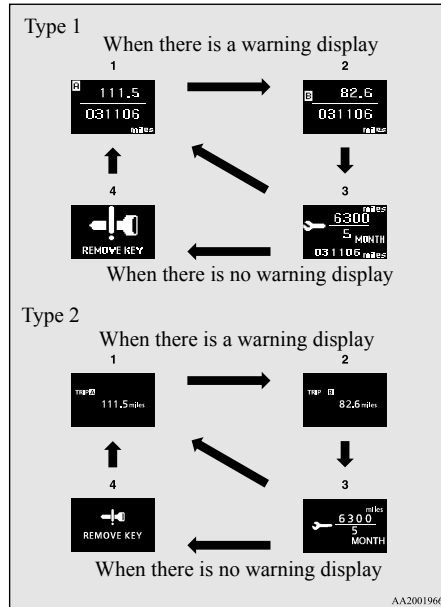

1- Odometer (Type 1)/Trip odometer **A**

- 2- Odometer (Type 1)/Trip odometer **B**
- 3- Service reminder
- 4- Redisplay of a warning display screen

Odometer/Trip odometer

N00555400142

Each time you lightly press the multi-information meter switch, the display screen changes as follows:

Odometer/Trip odometer **A** → Odometer/Trip odometer **B** → Service reminder → Redisplay of a warning display screen → Odometer/Trip odometer **A**.

Odometer

Shows the total distance traveled.

Trip odometer

Shows the distance traveled between two points.

Usage examples for trip odometer **A**, trip odometer **B**:

It is possible to measure two currently traveled distances, from home using trip odometer **A** and from a particular point on the way using trip odometer **B**.

To reset the trip odometer:

To return the display to 0, hold down the multi-information meter switch for about 2 seconds or more. Only the currently displayed value will be reset.

Example:

If trip odometer **A** is displayed, only trip odometer **A** will be reset.

Multi-information display

Refer to “Warning display list (With ignition switch in the “OFF” position)” on page 5-106.

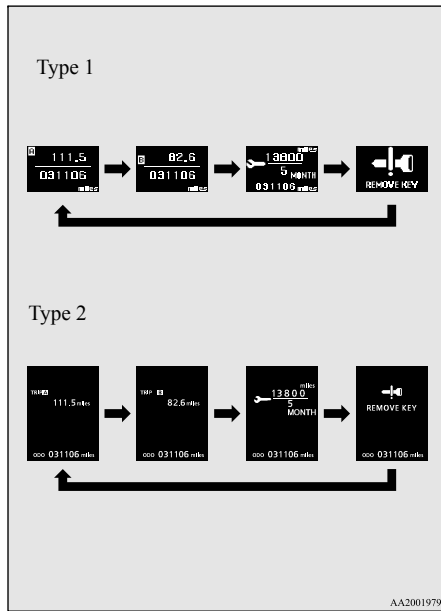

NOTE

- Both trip odometers **A** and **B** can count up to 9999.9 miles/kilometers. When a trip odometer goes past 9999.9 miles/kilometers, it returns to 0.0 miles/kilometers.
- When the battery is disconnected, the memories of trip odometer displays **A** and **B** are cleared, and their displays return to “0.0 miles/kilometers”.

Service reminder

N00555500039

Shows the distance and number of months until the next periodic inspection. Refer to “Service reminder” on page 5-95.

Interrupt display screen (With ignition switch in the “OFF” position)

N00559600184

When there is information to be announced, such as a key reminder, the buzzer sounds and switches to the warning display screen. Refer to the appropriate page and take the necessary measures.

When the cause of the warning display is eliminated, the warning display goes out automatically.

NOTE

- If there is no warning display, the switching sequence is: Odometer/Trip odometer **A** → Odometer/Trip odometer **B** → service reminder → Odometer/Trip odometer **A**.

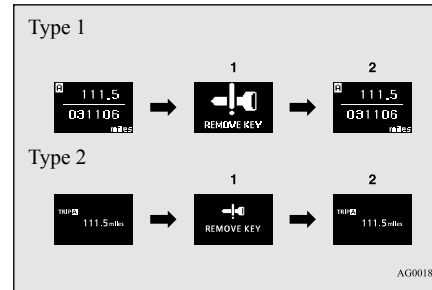

- Information generated
- Cause eliminated

Returning to the display screen from before the warning display

Even if the cause of the warning display is not eliminated, you can return to the screen that was displayed before the warning display.

If you press the multi-information meter switch, the display screen switches to the screen display from before the warning and the **A** warning (A) is displayed.

Multi-information display

5

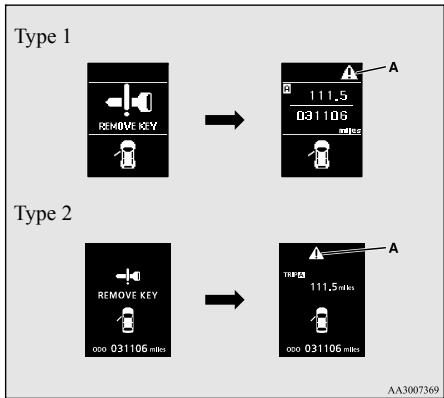

NOTE

- Warning display screens with a or mark displayed in the upper right of the screen can be switched. If you want to switch the display, press the multi-information meter switch as follows.

: Press lightly.

: Press for about 2 seconds or more.

Redisplay of a warning display screen

When the warning is displayed, if you lightly press the multi-information meter switch a few times, the warning display screen you switched from is redisplayed.

Refer to “Information screen (With ignition switch in the “OFF” position)” on page 5-86.

Door ajar warning display (With ignition switch in the “OFF” position)

N00559700101

If any of the doors or the rear hatch is not completely closed, the open door or rear hatch warning is displayed.

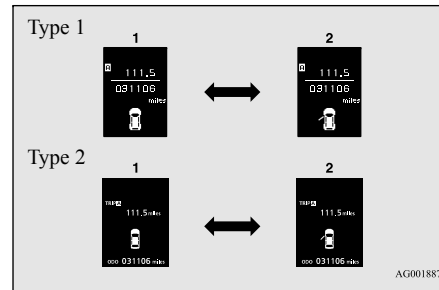

- Doors and rear hatch are closed
- Doors or rear hatch is open (driver's door is open in this example)

Information screen (With ignition switch turned from “OFF” to “ON” position)

N00555800188

When the ignition switch is turned to the “ON” position, the display screen changes in the following order.

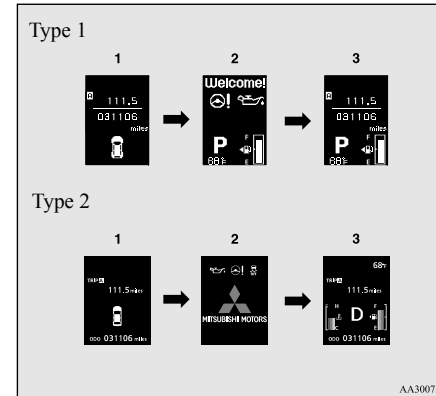

- Screen when the ignition switch is “OFF”
- System check screen
- Screen when the ignition switch is “ON”

System check screen

When the ignition switch is turned to the “ON” position, the system check screen is displayed for about 4 seconds. If there is no fault, information screen (when the ignition switch is “ON”) is displayed.

If there is a fault, the screen changes to warning display. Refer to “Warning display list (when the ignition switch is “ON”)” on page 5-109.

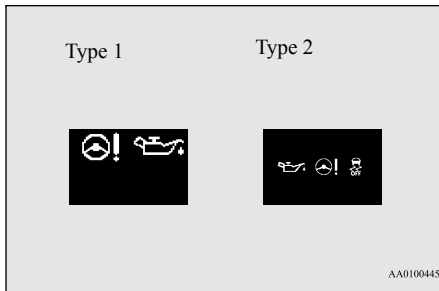

NOTE

- The system check screen display varies depending on your equipment.

Service reminder

When the time for periodic inspection arrives, the warning display is displayed for a few seconds after the screen that is initially displayed when the ignition switch is turned “ON”. Refer to “Service reminder” on page 5-95.

Type 1



Type 2



Warning display screen (With ignition switch in the “ON” position)

This is displayed when you press the multi-information meter switch and switch the warning display screen.

Multi-information display

This mark is also displayed if there is another warning other than the one displayed.

When the cause of the warning display is eliminated, the warning goes out automatically.

NOTE

- When the warning is displayed, the warning display screen can be redisplayed on the information screen. Refer to “Information screen (With ignition switch in the “OFF” position)” on page 5-86 or “Information screen (With ignition switch in the “ON” position)” on page 5-90.

5

Active stability control (ASC) OFF display screen (if so equipped)

N00556100058

This is displayed when the Active stability control (ASC) is turned off with the “ASC OFF” switch.

If there is a fault in the ASC, the “ASC OFF” display illuminates.

Refer to “ASC OFF switch” on page 5-70.

Multi-information display

Information screen (With ignition switch in the “ON” position)

N00556200219

Each time you lightly press the multi-information meter switch, the display screen changes in the following order.

5

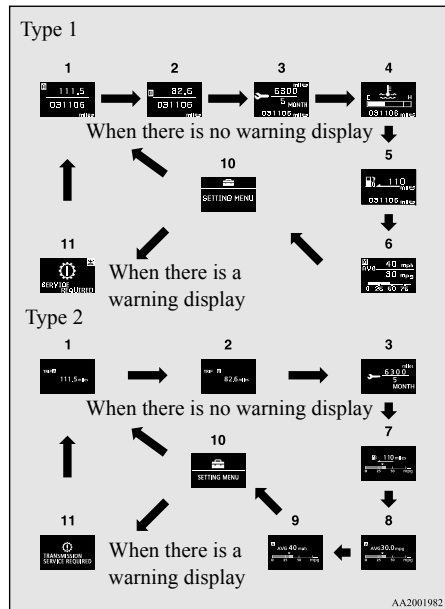

- Odometer (Type 1)/Trip odometer **[B]**
- Service reminder
- Engine coolant temperature display (Type 1)
- Driving range display (Type 1)
- Average speed display, average fuel consumption display, momentary fuel consumption display (Type 1)
- Driving range display, momentary fuel consumption display (Type 2)
- Average fuel consumption display, momentary fuel consumption display (Type 2)
- Average speed display, momentary fuel consumption display (Type 2)
- Function setting screen
- Redisplay of a warning display screen

NOTE

- While driving, the function setting screen is not displayed even if you operate the multi-information meter switch. Always park the vehicle in a safe place before operating. Refer to “Changing the function settings (With ignition switch in the “ON” position)” on page 5-96.
- When there is information to be announced, such as a system fault, the tone sounds and the screen display is changed. Refer to “Interrupt display screen (With ignition switch in the “ON” position)” on page 5-93.

Odometer/Trip odometer

The operation method is the same as when the ignition switch is in the “OFF” position. For further details, refer to “Odometer/Trip odometer” on page 5-86.

Service reminder

Shows the distance and number of months until the next periodic inspection. Refer to “Service reminder” on page 5-95.

Engine coolant temperature display

Shows the engine coolant temperature.

If the coolant becomes hot, “” will blink. Pay careful attention to the engine coolant temperature display while you are driving.

CAUTION

- If the engine is overheating, “” will blink. In this case, the bar graph is on the red zone. Immediately park the vehicle in a safe place and take the required measures. Refer to “Engine overheating” on page 8-4.

Multi-information display

Driving range display

Shows the approximate driving range (how many more miles or kilometers you can drive) with the current fuel level. When this driving range falls below 30 miles (50 km), “--” is displayed.

Refuel as soon as possible.

NOTE

- The driving range is determined based on the fuel consumption data. This may vary depending on the driving conditions and habits. Treat the distance displayed as just a rough guideline.
- When you refuel, the driving range display is automatically updated. However, if you only add a small amount of fuel, the correct value will not be displayed. Fill to a full tank whenever possible.
- When your vehicle is stopped on an extremely steep hill, the driving range value may change. This is due to the movement of fuel in the tank and does not indicate any problem.
- The display setting can be changed to the preferred units (miles or km). Refer to “Changing the function settings (With ignition switch in the “ON” position)” on page 5-96.

Average speed display

This displays the average speed from the last reset to the present.

There are 2 types of mode settings as follows. For details on how to change the average speed display setting, refer to “Changing the function settings (With ignition switch in the “ON” position)” on page 5-96.

Manual reset mode

- When the average speed is being displayed, if you hold down the multi-information meter switch, the average speed displayed at that time is reset.
- When the ignition switch is turned to the “ON” position from the “ACC” or “LOCK” position, the mode setting changes automatically from manual to auto. Switching to auto occurs automatically. If switching to manual mode is done, however, the data from the last reset is displayed.

Auto reset mode

- When the average speed is being displayed, if you hold down the multi-information meter switch, these calculations will be reset to zero.

- When the ignition switch has been set to the “ACC” or “LOCK” position for about 4 hours or more, the average speed display will automatically reset.

NOTE

- The average speed display and the average fuel consumption display can be reset separately in both auto reset mode and manual reset mode.
- “--” is displayed when the average speed cannot be measured.
- The initial (default) setting is “Auto reset mode”.
- The display setting can be changed to the preferred units (mph or km/h). Refer to “Changing the function settings (With ignition switch in the “ON” position)” on page 5-96.
- The average speed display memories for auto reset mode and manual reset mode are erased if the battery is disconnected.

5

Average fuel consumption display

This displays the average fuel consumption from the last reset to the present.

There are 2 types of mode settings as follows. For details on how to change the average fuel consumption display setting, refer to “Changing the function settings (With ignition switch in the “ON” position)” on page 5-96.

Multi-information display

The “” mark in the momentary fuel gauge shows the average fuel consumption. (Type 2)

Manual reset mode

5

- When the average fuel consumption is being displayed, if you hold down the multi-information meter switch, the average fuel consumption displayed at that time is reset.
- When the ignition switch is turned to the “ON” position from the “ACC” or “LOCK” position, the mode setting changes automatically from manual to auto.

Switching to auto occurs automatically. If switching to manual mode is done, however, the data from the last reset is displayed.

Auto reset mode

- When the average fuel consumption is being displayed, if you hold down the multi-information meter switch, these calculations will be reset to zero.
- When the ignition switch has been set to the “ACC” or “LOCK” position for about 4 hours or more, the average speed display will automatically reset.

NOTE

- The average speed display and the average fuel consumption display can be reset separately in both auto reset mode and manual reset mode.
- “---” is displayed when the average fuel consumption cannot be measured.
- The initial (default) setting is “Auto reset mode”.
- Average fuel consumption may vary depend on the driving conditions (road conditions, how you drive, etc.) The actual fuel consumption may differ from the fuel consumption displayed, so treat the fuel consumption displayed as just a rough guideline.
- The average fuel consumption display memories for auto reset mode and manual reset mode are erased if the battery is disconnected.
- The display setting can be changed to the preferred units {mpg (US), mpg (UK), L/100 km or km/L}. Refer to “Changing the function settings (With ignition switch in the “ON” position)” on page 5-96.

Momentary fuel consumption display

While driving, the momentary fuel consumption is shown with a bar graph.

When the momentary fuel consumption surpasses the average fuel consumption, the momentary fuel consumption is displayed with a green bar graph. (Type 2)

Be conscious of maintaining the momentary fuel consumption above the average fuel consumption, it can help you drive with the better fuel consumption.

NOTE

- When the momentary fuel consumption cannot be measured, a bar graph is not shown.
- The display setting can be changed to the preferred units {mpg (US), mpg (UK), L/100 km or km/L}. Refer to “Changing the function settings (With ignition switch in the “ON” position)” on page 5-96.
- It is possible to cancel the green bar graph. Refer to “Changing the function settings (With ignition switch in the “ON” position)” on page 5-96.

Function setting screen

The “Display language”, “Temperature unit”, “Fuel consumption unit”, and “Average fuel consumption and speed reset method” settings can be modified as desired.

For further details, refer to “Changing the function settings (With ignition switch in the “ON” position)” on page 5-96.

Interrupt display screen (With ignition switch in the “ON” position)

N00556300177

Warning display

When there is information to be announced, such as a system fault, a tone sounds and the information screen is switched to the warning display screen.

Refer to the warning list and take the necessary measures. Refer to “Warning display list (With ignition switch in the “ON” position)” on page 5-109.

When the cause of the warning display is eliminated, the warning display goes out automatically.



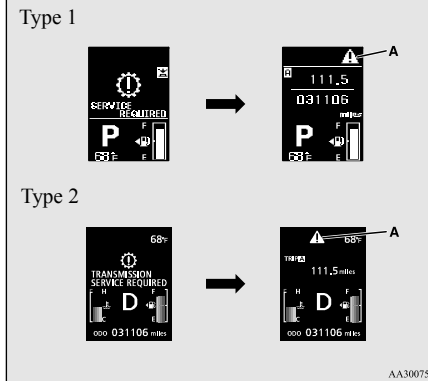

Returning to the display screen from before the warning display

Even if the cause of the warning display is not eliminated, you can return to the screen that was displayed before the warning display.

If you press the multi-information meter switch, the display screen switches to the screen display from before the warning and the  warning (A) is displayed.



NOTE

- Warning display screens with a  or  mark displayed in the upper right of the screen can be switched. If you want to switch the display, press the multi-information meter switch as follows.
 - : Press lightly.
 - : Press for about 2 seconds or more.

Redisplay of a warning display screen

When the  warning is displayed, if you lightly press the multi-information meter

Multi-information display

switch a few times, the warning display screen you switched from is redisplayed.

Other interrupt displays

The operation status of each system is displayed on the information screen.

For further details, refer to the appropriate page in the warning display list.

Refer to “Other interrupt displays (With ignition switch in the “ON” position)” on page 5-115.

Selector lever position display screen {continuously variable transmission (CVT)}

N00556400051

Shows the position of the selector lever. Refer to “Selector lever operation” on page 5-58.

Outside temperature display screen

N00556500108

Shows the temperature outside the vehicle.

Multi-information display

NOTE

- The display setting can be changed to the preferred units (°F or °C). Refer to “Changing the function settings (With ignition switch in the “ON” position)” on page 5-96.
- Depending on factors such as the driving conditions, the displayed temperature may vary from the actual outside temperature.

5

ECO mode indicator (if so equipped)

N0056870019

This indicator will be displayed when fuel-efficient driving is achieved.

Fuel remaining display screen

N00556600154

Shows the amount of fuel remaining.

Type 1 Type 2

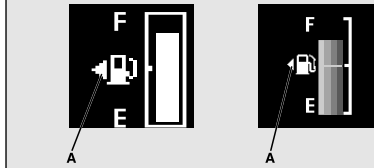

AG0018702

CAUTION

- Running out of gas could damage the catalytic converter. If the warning display appears, refuel as soon as possible.

NOTE

- It may take several seconds to stabilize the display after refilling the tank.
- If fuel is added with the ignition switch in the “ON” position, the remaining fuel display may indicate an incorrect fuel level.

Fuel tank filler door mark

The arrow (A) indicates that the fuel tank filler door is located on the left side of the vehicle. (Refer to “Filling the fuel tank” on page 3-3.)

Fuel remaining warning display

When the fuel level runs low, the information screen changes to the interrupt display of the fuel remaining warning display and the mark (B) on the fuel remaining display flashes slowly. If this warning display appears, refuel as soon as possible.

Type 1

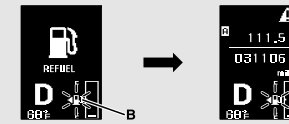

Type 2

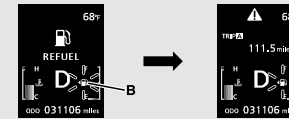

AA3007558

NOTE

- On hills or curves, the display may be incorrect due to the movement of fuel in the tank.

Multi-information display

Service reminder

N00556701282

Displays the approximate time until the next recommended periodic inspection. “---” is displayed when the inspection time has arrived.

NOTE

- Shows the time until the periodic inspection every 6 months and 7,500 miles (12,000 km).

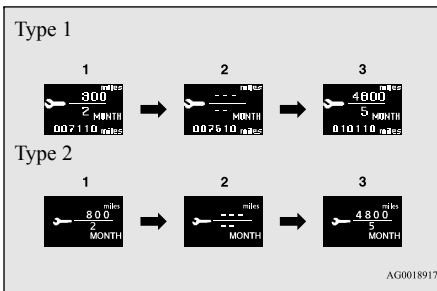

- Shows the time until the next periodic inspection.

NOTE

- Shows the distance in units of 100 miles (100 km) and the time in units of 1 month.

- This informs you that a periodic inspection is due. Contact an authorized Mitsubishi Motors dealer or a repair facility of your choice to have the system checked.

At that time, when the ignition switch is switched from the “OFF” position to the “ON” position, the warning display is displayed for a few seconds on the information screen.

Type 1



Type 2



- After your vehicle is inspected at an authorized Mitsubishi Motors dealer, it displays the time until the next periodic inspection.

To reset

The “---” display can be reset while the ignition switch is in the “OFF” position. When the display is reset, the time until the next periodic inspection is displayed and the warning display is no longer displayed when the ignition switch is switched from the “OFF” position to the “ON” position.

5

- When you lightly press the multi-information meter switch, the information screen changes to the service reminder display screen.

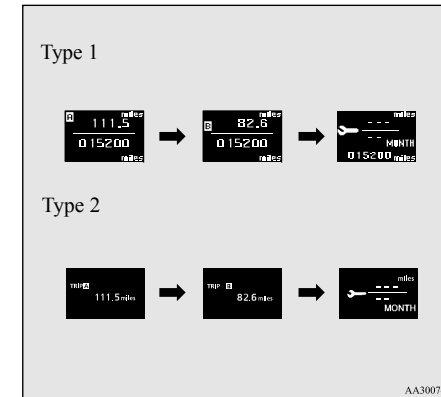

Multi-information display

5

- Press and hold the multi-information meter switch (for about 2 seconds or more) to display “” and make it flash. (If there is no operation for about 10 seconds with this indicator flashing, the display returns to the previous screen.)
- With this indicator flashing, if you lightly press the multi-information meter switch, the screen switches from “---” to “CLEAR”. After that, the time until the next periodic inspection is shown.

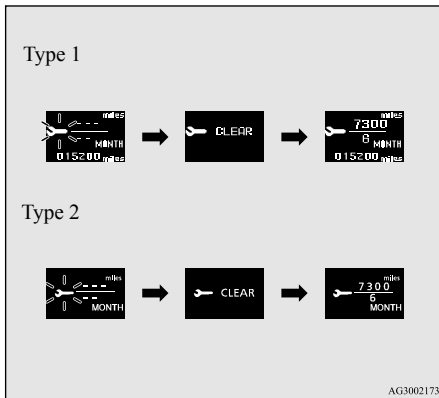

CAUTION

- The customer is responsible for making sure that regular inspections and maintenance and periodic inspections and maintenance are performed. Inspections and maintenance must be performed to prevent accidents and malfunctions.

NOTE

- The “---” display cannot be reset while the ignition switch is in the “ON” position.
- When “---” is displayed, after a certain distance and a certain period of time, the display is reset and the time until the next periodic inspection is displayed.
- If you accidentally reset the display, consult an authorized Mitsubishi Motors dealer for assistance.

Door ajar warning display (With ignition switch in the “ON” position)

Type 1



Type 2



If any of the doors or the rear hatch is not completely closed, this displays the open door or rear hatch.

If the speed increases to about 5 mph (8 km/h) or higher with a door or rear hatch ajar, a buzzer will sound 4 times to inform you that a door or rear hatch is ajar.

CAUTION

- Always make sure that the warning display goes out before beginning to drive.

Changing the function settings (With ignition switch in the “ON” position)

N00556801225

- Park your vehicle in a safe place. Fully apply the parking brake and move the gearshift lever (manual transaxle) into the “N” (Neutral) position, the selector lever {continuously variable transmission (CVT)} into the “P” (PARK) position.

Multi-information display

2. When you lightly press the multi-information meter switch, the information screen changes to the function setting screen. Refer to “Information screen (With ignition switch in the “ON” position)” on page 5-90.

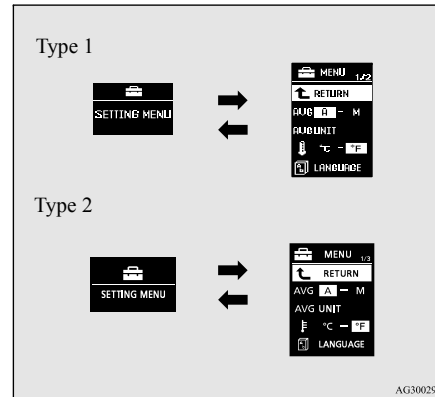
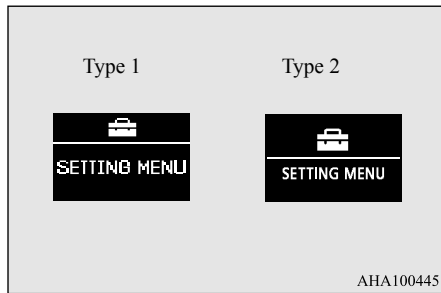

NOTE

- To return the menu screen to the function setting screen, press and hold the multi-information meter switch (for about 2 seconds or more).
- If no operations are made within about 15 seconds of the menu screen being displayed, the display returns to the function setting screen.

CAUTION

- For safety, stop the vehicle before operating. While driving, even if you operate the multi-information meter switch, the function setting screen is not displayed.

3. Press and hold the multi-information meter switch (for about 2 seconds or more) to switch from the setting mode screen to the menu screen.

4. Select the item to change on the menu screen and change to the desired setting. For further details on the operation methods, refer to the following sections.

Refer to “Changing the reset mode for average fuel consumption and average speed” on page 5-97.

Refer to “Changing the fuel consumption display unit” on page 5-98.

Refer to “Changing the temperature unit” on page 5-99.

Refer to “Changing the display language” on page 5-100.

Refer to “Operation sound setting” on page 5-100.

Refer to “Changing the amount of time until “REST REMINDER” is displayed” on page 5-101.

Refer to “Changing the turn signal sound” on page 5-102.

Refer to “Changing the momentary fuel consumption display (Type 2)” on page 5-102.

Refer to “Returning to the factory settings” on page 5-102.

Changing the reset mode for average fuel consumption and average speed

N00557000197

You can change the mode condition for the average fuel consumption and average speed display to “Auto reset” or “Manual reset”.

Multi-information display

1. Press and hold the multi-information meter switch (for about 2 seconds or more) to switch from the setting mode screen to the menu screen.

Refer to “Changing the function settings (With ignition switch in the “ON” position)” on page 5-96.

5

2. Lightly press the multi-information meter switch to select “AVG” (average fuel consumption and average speed setting).

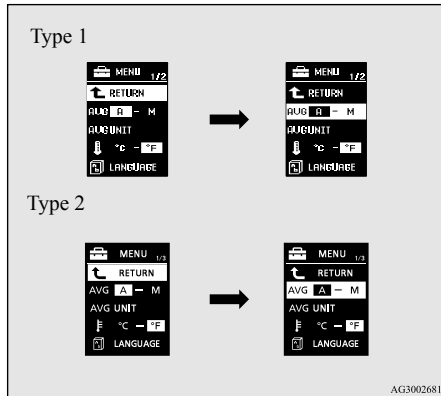

3. Press and hold the multi-information meter switch (for about 2 seconds or more) to switch in sequence from A or 1 (Auto reset mode) → M, 2 or P (Manual reset mode) → A or 1 (Auto reset mode). The setting will change to the selected mode condition.

Manual reset mode

- If you press and hold the multi-information meter switch when the average fuel consumption and average speed are displayed, these calculations will be reset to zero.
- When the ignition switch is turned to the “ON” position from the “ACC” or “LOCK” position, the mode setting changes automatically from manual to auto.

Switching to auto occurs automatically. If switching to manual mode is done, however, the data from the last reset is displayed.

Auto reset mode

- When the average fuel consumption and average speed are being displayed, if you hold down the multi-information meter switch, these calculations will be reset to zero.
- When the ignition switch has been set to the “ACC” or “LOCK” position for about 4 hours or more, the average fuel consumption display and the average speed display will automatically reset.

NOTE

- The average speed display and average fuel consumption display can be reset separately in both auto reset mode and manual reset mode.
- The average speed display memories and average fuel consumption memories for auto reset mode and manual reset mode are erased if the battery is disconnected.
- The initial (default) setting is “Auto reset mode”.

Changing the fuel consumption display unit

N00557100097

The fuel consumption display unit can be changed. The distance, speed, and amount units are also changed to match the selected fuel consumption unit.

1. Press and hold the multi-information meter switch (for about 2 seconds or more) to change from the setting mode screen to the menu screen. Refer to “Changing the function settings (With ignition switch in the “ON” position)” on page 5-96.
2. Lightly press the multi-information meter switch to select “AVG UNIT” (fuel consumption display unit setting).

Multi-information display

The distance and speed units are also changed in the following combinations to match the selected fuel consumption unit.

Fuel economy	Distance (driving range)	Speed (average speed)
mpg (US)	mile(s)	mph
mpg (UK)	mile(s)	mph
km/L	km	km/h
L/100 km	km	km/h

5

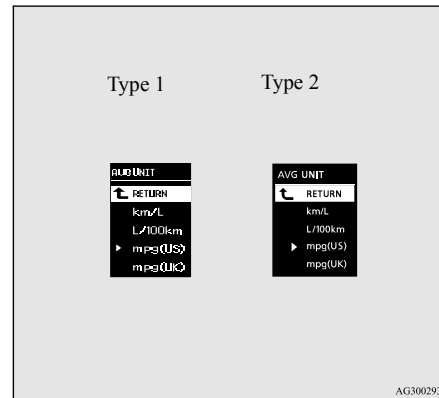
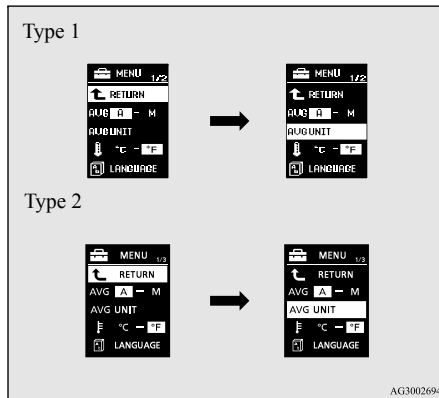

- Press and hold the multi-information meter switch (for about 2 seconds or more) to display “AVG UNIT” (fuel consumption display unit setting).
- Lightly press the multi-information meter switch to switch in sequence from km/L →L/100 km →mpg (US) →mpg (UK) →RETURN →km/L.

- Press and hold the multi-information meter switch (for about 2 seconds or more) to change the setting to the selected unit.

NOTE

- The display units for the driving range, the average fuel consumption, the average speed and the momentary fuel consumption are changed, but the units for the indicating needle (speedometer), the odometer and the trip odometer will remain unchanged.
- If the battery is disconnected, the memory of the unit setting is erased and is automatically set to {mpg (US) or L/100 km}.

Changing the temperature unit

N00557200144

The temperature display unit can be changed.

- Press and hold the multi-information meter switch (for about 2 seconds or more) to change from the setting mode screen to the menu screen. Refer to “Changing the function settings (With ignition switch in the “ON” position)” on page 5-96.
- Lightly press the multi-information meter switch to select “” (temperature unit setting).

Multi-information display

5

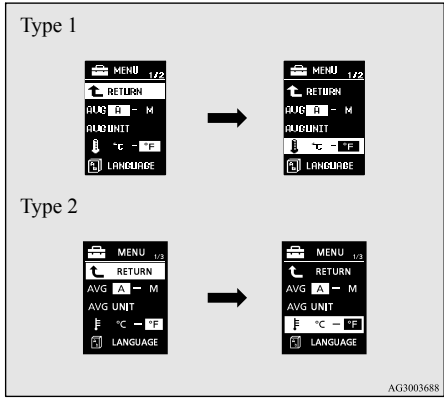

3. Press and hold the multi-information meter switch (for about 2 seconds or more) to change in sequence from °F → °C → °F.
The setting is changed to the selected temperature unit.

NOTE

- If the battery is disconnected, the memory of the unit setting is erased and is automatically set to °F (°C).

Changing the display language

N00557300158

The language of the multi-information display can be changed.

5-100 Features and controls

1. Press and hold the multi-information meter switch (for about 2 seconds or more) to change from the setting mode screen to the menu screen.
Refer to “Changing the function settings (With ignition switch in the “ON” position)” on page 5-96.
2. Lightly press the multi-information meter switch to select “LANGUAGE” (language setting).

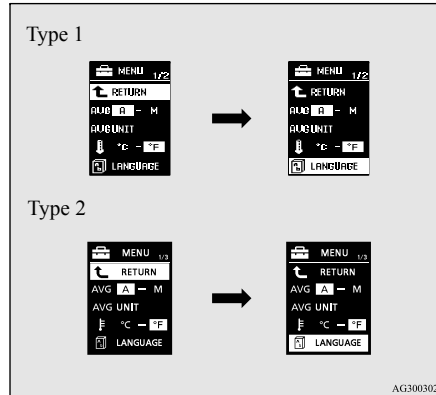

3. Press and hold the multi-information meter switch (for about 2 seconds or more) to display “LANGUAGE” (language setting).
4. Lightly press the multi-information meter switch to select the desired language.

5. Press and hold the multi-information meter switch (for about 2 seconds or more) to change the setting to the selected language.

NOTE

- If the battery is disconnected, the memory of the language setting is erased and is automatically set to ENGLISH.
- If “---” is selected in the language setting, a warning message is not displayed when there is a warning display or interrupt display.

Operation sound setting

N00557400133

You can turn off the operation sounds of the multi-information meter switch and rheostat meter illumination button.

1. Press and hold the multi-information meter switch (for about 2 seconds or more) to switch from the setting mode screen to the menu screen.
Refer to “Changing the function settings (With ignition switch in the “ON” position)” on page 5-96.
2. Lightly press the multi-information meter switch to select “” (operation sound setting).

Multi-information display

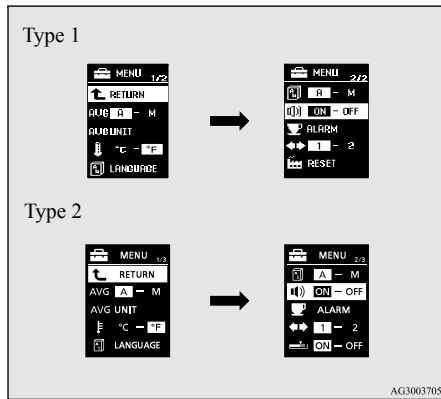

Changing the amount of time until “REST REMINDER” is displayed

N00557500150

The amount of time until the display appears can be changed.

1. Press and hold the multi-information meter switch (for about 2 seconds or more) to switch from the setting mode screen to the menu screen. Refer to “Changing the function settings (With ignition switch in the “ON” position)” on page 5-96.
2. Lightly press the multi-information meter switch to select “ALARM” (rest time setting).

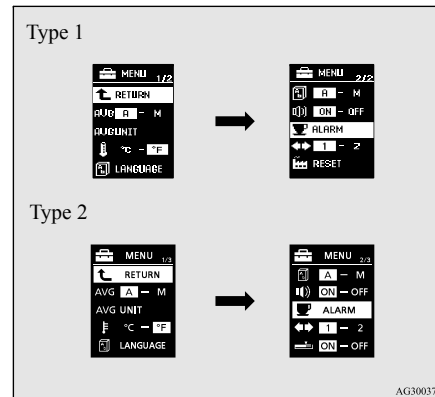

3. Press and hold the multi-information meter switch (for about 2 seconds or more) to display “ALARM” (rest time setting).

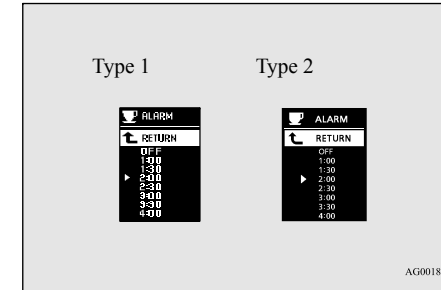

5

4. Lightly press the multi-information meter switch to select the amount of time until the display appears.
5. Press and hold the multi-information meter switch (for about 2 seconds or more) to change the setting to the selected time.

3. Press and hold the multi-information meter switch (for about 2 seconds or more) to switch in sequence from ON (operation sound on) → OFF (operation sound off) → ON (operation sound on). The setting is changed to the selected condition.

NOTE

- If the battery is disconnected, the memory of the operation sound setting is erased and is automatically set to “ON” (operation sound on).
- The operation sound setting only deactivates the operation sound of the multi-information meter switch and rheostat meter illumination button. The warning display and other sounds cannot be deactivated.

NOTE

- If the battery is disconnected, the memory of the unit setting is erased and is automatically set to the “OFF”.
- The drive time is reset when the ignition switch is in the “OFF” position.

Multi-information display

Changing the turn signal sound

N00563500070

It is possible to change the turn signal sound.

1. Press and hold the multi-information meter switch for about 2 seconds or more to switch from the setting mode screen to the menu screen.

Refer to “Changing the function settings (With ignition switch in the “ON” position)” on page 5-96.

2. Lightly press the multi-information meter switch to select  (changing the turn signal sound)

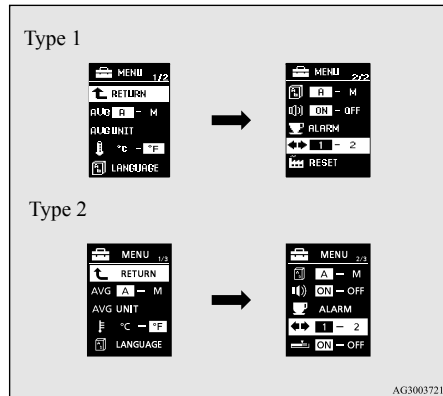

3. Press and hold the multi-information meter switch for about 2 seconds or more to switch in sequence from 1 (turn signal sound 1) → 2 (turn signal sound 2) → 1 (turn signal sound 1).

The setting changes to the selected turn signal sound.

Changing the momentary fuel consumption display (Type 2)

N00563600013

It is possible to change the bar graph setting of the momentary fuel consumption display.

1. Press and hold the multi-information meter switch for about 2 seconds or more to switch from the setting mode screen to the menu screen.

Refer to “Changing the function settings (With ignition switch in the “ON” position)” on page 5-96.

2. Lightly press the multi-information meter switch to select  (changing the momentary fuel consumption display)

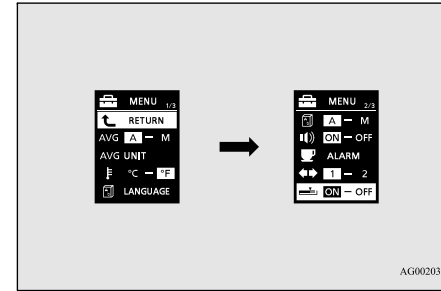

3. Press and hold the multi-information meter switch for about 2 seconds or more to switch in sequence from ON (with the green bar graph) → OFF (without the green bar graph) → ON (with the green bar graph). The setting changes to the selected bar graph setting.

Returning to the factory settings

N00557600180

All of the function settings can be returned to their factory settings.

1. Press and hold the multi-information meter switch (for about 2 seconds or more) to change from the setting mode screen to the menu screen.

Refer to “Changing the function settings (With ignition switch in the “ON” position)” on page 5-96.

Multi-information display

2. Lightly press the multi-information meter switch to select “RESET” (return to the factory settings).

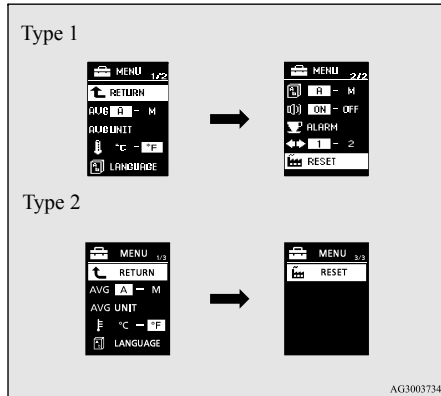

NOTE

- Cooperative language setting: A
- Operation sounds: ON (Operation sound on)
- “REST REMINDER” display: OFF
- Turn signal sound: Turn signal sound 1
- Momentary fuel consumption with the green bar graph (Type 2): ON

5

3. Press and hold the multi-information meter switch (for about 5 seconds or more), the buzzer sounds and all of the function settings are returned to the factory settings.

NOTE

- The factory settings are as follows.
 - Average fuel consumption and average speed reset mode: A (Auto reset)
 - Fuel consumption display unit: mpg (US) or L/100 km
 - Temperature unit: °F (Fahrenheit) or °C (Celsius)
 - Display language: ENGLISH

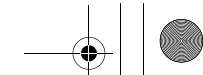

Indicator light, warning light, and information screen display list

Information screen display list

N00557900040

When there is information to be announced, such as light reminders, the tone sounds and the screen switches to the displays shown below. Refer to the appropriate page and take the necessary measures.

When the cause of the warning display is eliminated, the warning display goes out automatically.

Refer to “Warning display list (With ignition switch in the “OFF” position)” on page 5-106.

Refer to “Warning display list (With ignition switch in the “ON” position)” on page 5-109.

Refer to “Other interrupt displays (With ignition switch in the “ON” position)” on page 5-115.

NOTE

- Abnormal voltage or a static electricity discharge is generated by the operation of installed electronics (including after-market parts).

If the warning display has occurred a number of times, take your vehicle to an authorized Mitsubishi Motors dealer or a repair facility of your choice and have the system checked.



NOTE

- In the following cases, a warning may be displayed on the information screen and the buzzer may sound for a few seconds, at times.

This is caused by the system picking up interference such as strong electromagnetic waves or noise, and is not a functional problem.

- An extremely strong electromagnetic wave is received from a source such as an illegal radio set, a spark from a wire, or a radar station.

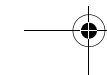
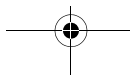







Indicator light, warning light, and information screen display list



Warning display list (With ignition switch in the “OFF” position)

N00558001247

5

Screen type 1	Screen type 2	Cause	Do this (Reference)
 REMOVE KEY	 REMOVE KEY	<ul style="list-style-type: none"> You have forgotten to remove the key from the ignition switch. 	<ul style="list-style-type: none"> Remove the key. Refer to “Key reminder system” on page 5-36.
 TURN OFF LIGHTS	 TURN OFF LIGHTS	<ul style="list-style-type: none"> You have forgotten to turn off the lights. 	<ul style="list-style-type: none"> Refer to “Light auto-cutout function (headlights and other lights)” on page 5-121.
 ALARM ACTIVATING	 ALARM ACTIVATING	<ul style="list-style-type: none"> The theft-alarm is operating. 	<ul style="list-style-type: none"> Refer to “Theft-alarm system” on page 5-40.
		<ul style="list-style-type: none"> Immobilizer is registered. 	<ul style="list-style-type: none"> Refer to “Electronic immobilizer (Anti-theft starting system)” on page 5-4, 5-27.











Indicator light, warning light, and information screen display list

Screen type 1	Screen type 2	Cause	Do this (Reference)
		<ul style="list-style-type: none"> After turning off the engine, an attempt was made to open the driver's door with the ignition switch in any position other than "LOCK" (PUSH OFF). 	<ul style="list-style-type: none"> Turn the ignition switch to the "LOCK" (PUSH OFF) position. Refer to "Ignition switch return reminder system" on page 5-36.
		<ul style="list-style-type: none"> An attempt was made to lock all the doors and the rear hatch with the ignition switch in any position other than "LOCK" (PUSH OFF). 	<ul style="list-style-type: none"> Turn the ignition switch to the "LOCK" (PUSH OFF) position. Refer to "Ignition switch turn-off reminder system" on page 5-19.

5

Indicator light, warning light, and information screen display list



5

Screen type 1	Screen type 2	Cause	Do this (Reference)
 KEY BATTERY LOW	 KEY BATTERY LOW	● There is a fault in the F.A.S.T.-key.	● Refer to “F.A.S.T.-key” on page 5-12.
 KEY MISSING	 KEY NOT DETECTED		
 CONFIRM KEY LOCATION	 KEY STILL IN VEHICLE		
 CHECK DOORS	 CHECK DOORS		
 SERVICE REQUIRED	 KEYLESS OPERATION SYSTEM SERVICE REQUIRED		

Indicator light, warning light, and information screen display list

Warning display list (With ignition switch in the “ON” position)











N00558101349

Screen type 1	Screen type 2	Cause	Do this (Reference)
		<ul style="list-style-type: none"> There is a fault in the EPS. 	<ul style="list-style-type: none"> Have the vehicle inspected by an authorized Mitsubishi Motors dealer or a repair facility of your choice as soon as possible. Refer to “Electric power steering system (EPS)” on page 5-69.











5

Indicator light, warning light, and information screen display list

5













Screen type 1	Screen type 2	Cause	Do this (Reference)
 <p>KEY BATTERY LOW</p>	 <p>KEY BATTERY LOW</p>	<ul style="list-style-type: none"> There is a fault in the F.A.S.T.-key. 	<ul style="list-style-type: none"> Refer to “F.A.S.T.-key” on page 5-12.
 <p>KEY MISSING</p>	 <p>KEY NOT DETECTED</p>		
 <p>CONFIRM KEY LOCATION</p>	 <p>KEY STILL IN VEHICLE</p>		
 <p>CHECK DOORS</p>	 <p>CHECK DOORS</p>		
 <p>SERVICE REQUIRED</p>	 <p>KEYLESS OPERATION SYSTEM SERVICE REQUIRED</p>		
		<ul style="list-style-type: none"> Immobilizer is registered. 	<ul style="list-style-type: none"> Refer to “Electronic immobilizer (Anti-theft starting system)” on page 5-4, 5-27.

Indicator light, warning light, and information screen display list











Screen type 1	Screen type 2	Cause	Do this (Reference)
		<ul style="list-style-type: none"> ● The brake fluid level is low. ● There is a fault in the brake system. 	<ul style="list-style-type: none"> ● Park the vehicle in a safe place and contact an authorized Mitsubishi Motors dealer or a repair facility of your choice for assistance. Refer to “Brake warning display” on page 5-118.
		<ul style="list-style-type: none"> ● There is a fault in the Anti-lock braking system. 	<ul style="list-style-type: none"> ● Avoid sudden braking and high-speed driving, park the vehicle in a safe place, and take corrective measures. Refer to “Anti-lock braking system warning light/display” on page 5-67.
		<ul style="list-style-type: none"> ● The tire pressure in one of the tires (except spare tire) is low. 	<ul style="list-style-type: none"> ● Refer to “Tire Pressure Monitoring System” on page 5-76.
		<ul style="list-style-type: none"> ● There is a fault in the Tire Pressure Monitoring System. 	<ul style="list-style-type: none"> ● Refer to “Tire Pressure Monitoring System” on page 5-76.
		<ul style="list-style-type: none"> ● One of the doors or the rear hatch is not completely closed. The open door or rear hatch is displayed. 	<ul style="list-style-type: none"> ● Close the door or rear hatch. Refer to “Door ajar warning display (With ignition switch in the “OFF” position)” on page 5-88.

Indicator light, warning light, and information screen display list

5





Screen type 1	Screen type 2	Cause	Do this (Reference)
 CLOSE HOOD	 CLOSE HOOD	<ul style="list-style-type: none"> The engine hood is open. 	<ul style="list-style-type: none"> Close the engine hood. Refer to “Engine hood” on page 9-3.
 CHECK	 ENGINE OVERHEATING STOP SAFELY	<ul style="list-style-type: none"> The engine is overheated. 	<ul style="list-style-type: none"> Park the vehicle in a safe place and take corrective measures. Refer to “Engine overheating” on page 8-4.
 SLOW DOWN	 TRANSMISSION OVERHEATING SLOW DOWN	<ul style="list-style-type: none"> The continuously variable transmission (CVT) fluid temperature is increased. 	<ul style="list-style-type: none"> Park the vehicle in a safe place and take corrective measures. Refer to “Continuously variable transmission (CVT)” on page 5-58.
 FASTEN SEAT BELT	 FASTEN SEAT BELT	<ul style="list-style-type: none"> The seat belt is not fastened when the ignition switch is in the “ON” position. 	<ul style="list-style-type: none"> Fasten your seat belt properly. Refer to “Driver’s seat belt reminder/warning light and display” on page 4-11.
 SERVICE REQUIRED	 FUEL SYSTEM SERVICE REQUIRED	<ul style="list-style-type: none"> There is a fault in the fuel system. 	<ul style="list-style-type: none"> Contact an authorized Mitsubishi Motors dealer or a repair facility of your choice to have the system checked.
 RELEASE PARKING BRAKE	 RELEASE PARKING BRAKE	<ul style="list-style-type: none"> The vehicle is being driven with the parking brake still applied. 	<ul style="list-style-type: none"> Release the parking brake. Refer to “Brake warning display” on page 5-118.

Indicator light, warning light, and information screen display list

Screen type 1	Screen type 2	Cause	Do this (Reference)
 CHECK	 LOW OIL PRESSURE	<ul style="list-style-type: none"> There is a fault in the engine oil circulation system. 	<ul style="list-style-type: none"> Park your vehicle in a safe place as soon as possible and contact an authorized Mitsubishi Motors dealer or a repair facility of your choice to have the system checked. Refer to “Oil pressure warning display” on page 5-119.
 SERVICE REQUIRED	 CHARGING SYSTEM SERVICE REQUIRED	<ul style="list-style-type: none"> There is a fault in the charging system. 	<ul style="list-style-type: none"> Park your vehicle in a safe place as soon as possible and contact an authorized Mitsubishi Motors dealer or a repair facility of your choice for assistance. Refer to “Charging system warning display” on page 5-119.
 SERVICE REQUIRED	 AIRBAG SYSTEM SERVICE REQUIRED	<ul style="list-style-type: none"> There is a fault in the SRS airbag or the seat belt pre-tensioner system. 	<ul style="list-style-type: none"> Contact an authorized Mitsubishi Motors dealer or a repair facility of your choice to have the system checked, immediately. Refer to “SRS warning light/display” on page 4-27.
 SERVICE REQUIRED	 ASC SYSTEM SERVICE REQUIRED	<ul style="list-style-type: none"> There is a fault in the Active stability control (ASC). 	<ul style="list-style-type: none"> Contact an authorized Mitsubishi Motors dealer or a repair facility of your choice to have the system checked. Refer to “Active stability control (ASC)” on page 5-69.
 SERVICE REQUIRED	 TRANSMISSION SERVICE REQUIRED	<ul style="list-style-type: none"> There is a fault in the CVT. 	<ul style="list-style-type: none"> Contact an authorized Mitsubishi Motors dealer or a repair facility of your choice to have the system checked. Refer to “Continuously variable transmission (CVT)” on page 5-58.

Indicator light, warning light, and information screen display list

5

Screen type 1	Screen type 2	Cause	Do this (Reference)
 REFUEL	 REFUEL	<ul style="list-style-type: none"> ● The fuel is running low. 	<ul style="list-style-type: none"> ● Refuel as soon as possible. Refer to “Fuel remaining display screen” on page 5-94.
 POSSIBLE ICY ROADS	 POSSIBLE ICY ROADS	<ul style="list-style-type: none"> ● The outside temperature is 37 °F (3 °C) or less. 	<ul style="list-style-type: none"> ● Be careful driving on frozen ground. ● The ground may be frozen even when this warning is not displayed, so drive carefully.

Indicator light, warning light, and information screen display list

Other interrupt displays (With ignition switch in the “ON” position)



N00558201294

The operation status of each system is displayed on the information screen. For further details, refer to the appropriate page for each system.

Screen	System operation status	Reference
	<ul style="list-style-type: none"> When the Active stability control (ASC) is operating. 	<ul style="list-style-type: none"> Refer to “Active stability control (ASC)” on page 5-69.

5



This informs you that a periodic inspection is due.

Screen type 1	Screen type 2	Do this
		Have an inspection made by an authorized Mitsubishi Motors dealer. For further details, refer to “Service reminder” on page 5-95.

Indicators

The rest time can be set.

5

Screen type 1	Screen type 2	Do this
		<p>Park the vehicle in a safe place, turn off the engine, and take a rest. Use this display as rough guide for taking rests during a long drive. The interval from the start of your trip until this message is displayed can be set. Refer to “Changing the function settings (With ignition switch in the “ON” position)” on page 5-96.</p> <p>The display and buzzer alert the driver when the set time is reached. If you continue to drive without having a rest, the buzzer sounds about every 5 minutes to encourage you to take a rest.</p> <ul style="list-style-type: none"> • In the following cases, the time driven is reset and the display returns to the previous display screen. After this, when the set time is reached again, the display and buzzer encourage you to take a rest. <ul style="list-style-type: none"> • The buzzer sounds 3 times. • The ignition switch is turned to the “OFF” position. • The multi-information meter switch is held (for about 2 seconds or more).

Indicators

N00519900127

Turn signal indicators/Hazard warning lights

N00520000229

The arrows will flash in time with the corresponding exterior turn signals when the turn signal lever is used.

Both arrows will flash when the hazard warning flasher switch is pressed.

NOTE

- If the indicator flashes faster than usual or if the indicator stays on without flashing, check for a malfunctioning turn signal light bulb or turn signal connection.

High beam indicator

N00520100086

A blue light comes on when the headlights are on high beam.

Front fog light indicator (if so equipped)

N00520200205

This indicator comes on while the front fog lights are on.

Position indicator

N00551300026

This indicator light illuminates while the position lights are on.

Warning lights

Warning lights

N00520300147

Brake warning light

N00520400366

When the ignition switch is turned to the “ON” position, this indicator normally comes on and goes out a few seconds later. A warning is also displayed in the multi-information display.

The warning light also illuminates after starting the engine under the following conditions:

- When the parking brake is still applied.
- When the brake fluid level is low.
- When the brake system circuit is not working properly.

Before driving, be sure that the parking brake is fully released and brake warning light is off.

CAUTION

- If the brake warning light and the anti-lock braking system warning light are illuminated at the same time, the braking force distribution function will not operate, so the vehicle may be destabilized during sudden braking under the following conditions.

CAUTION

- When the brake warning light does not go out even when the parking brake is released.
- When the brake warning light stays on while driving.
- If the above occurs, avoid sudden braking and high-speed driving. Park the vehicle in a safe place, and contact an authorized Mitsubishi Motors dealer or a repair facility of your choice as soon as possible.
- The vehicle should be brought to a halt in the following manner when brake performance is deteriorated.
 - Confirm that the vehicle slows down when you press down on the brake pedal harder than usual. In some cases, the brake pedal may go all the way to the floor.
 - Should the brakes fail, use engine braking to reduce your speed and slowly apply the parking brake.
 - Depress the brake pedal to illuminate the stop lights to alert the vehicles behind you.
- Do not suddenly apply the parking brake while driving. This may cause the rear wheels to lock and cause an accident.

Engine malfunction indicator (“Check engine light”)

N00520501827

This indicator is a part of the onboard diagnostic (OBD) system which monitors the

emissions, engine control system or continuously variable transmission (CVT) control system. If a problem is detected in one of these systems, this indicator illuminates or flashes. When the ignition switch is turned to the “ON” position, this indicator normally comes on and goes off after the engine has started.

This indicator will come on if the fuel tank filler cap is not properly tightened. If this indicator comes on and stays on after refueling, stop the engine and check that the cap is properly tightened. (Turn the cap clockwise until you hear clicking sounds.)

If this indicator does not go off after several seconds or lights up while driving, have the system checked as soon as possible at an authorized Mitsubishi Motors dealer or a repair facility of your choice.

CAUTION

- Driving for a long time with the engine malfunction indicator on may cause more damage to the emission control system. This could also affect fuel economy and drivability.
- If this indicator does not come on when the ignition switch is turned to the “ON” position, have the system checked at an authorized Mitsubishi Motors dealer or a repair facility of your choice.

5

Information screen display

⚠ CAUTION

- If the engine malfunction indicator comes on while the engine is running, avoid driving at high speeds.
During vehicle operation with the indicator on, the vehicle may not accelerate when you depress the accelerator pedal.
When the vehicle is stationary with the indicator on, you must depress the brake pedal more firmly than usual since the engine idling speed is higher than usual and a vehicle equipped with a CVT has a stronger tendency to creep forward.

📖 NOTE

- Do not disconnect the battery cable when the engine malfunction indicator (“Check engine light”) is on.
The engine electronic control module stores critical OBD information (especially exhaust emission data), which may be lost if the battery cable is disconnected while the engine malfunction indicator is on. This will make it difficult to diagnose the cause of future problems.

Charging system warning light

N00520600296

This light comes on in the event of a malfunction in the charging system or when the ignition switch is turned to the “ON” position

(engine off). A warning is also displayed in the multi-information display. When the engine is started, the light should go out. Check to make sure that the light has gone out before driving.

⚠ CAUTION

- If the warning light stays on while the engine is running, park your vehicle in a safe place as soon as possible and contact an authorized Mitsubishi Motors dealer or a repair facility of your choice to have the system checked.

Information screen display

N00558300025

Brake warning display

N00558400101

Type 1



Type 2



This warning is displayed if the vehicle is being driven with the parking brake still applied. The warning light in the instrument cluster only comes on when the parking brake is applied.

⚠ CAUTION

- If a vehicle is driven without releasing the parking brake, the brakes will overheat, resulting in ineffective braking and possible brake failure.
If this warning is displayed while driving, release the parking brake.

Type 1



Type 2



When the ignition switch is turned to the “ON” position, if the brake fluid is low, this warning is displayed.
The warning light in the instrument cluster also illuminates.

Information screen display

CAUTION

- If this warning stays on and does not go out while driving, there is a danger of ineffective braking. If this happens, park the vehicle in a safe place, and contact an authorized Mitsubishi Motors dealer or a repair facility of your choice.
- If the brake warning display, brake warning light, and the Anti-lock braking system warning light are illuminated at the same time, the braking force distribution function will not operate, so the vehicle may be destabilized during sudden braking. Avoid sudden braking and high-speed driving. Park the vehicle in a safe place, and contact an authorized Mitsubishi Motors dealer or a repair facility of your choice.
- The vehicle should be brought to a halt in the following manner when brake performance is deteriorated.
 - Confirm that the vehicle slows down when you press down on the brake pedal harder than usual. In some cases, the brake pedal may go all the way to the floor.
 - Should the brakes fail, use engine braking to reduce your speed and slowly apply the parking brake. Depress the brake pedal to illuminate the stop lights to alert the vehicles behind you.

Charging system warning display

N00558600073

Type 1



Type 2



If there is a fault in the charging system, the warning display is displayed on the information screen in the multi-information display. The warning light in the instrument cluster also illuminates.

CAUTION

- If warnings are displayed while the engine is running, park your vehicle in a safe place as soon as possible and contact an authorized Mitsubishi Motors dealer or a repair facility of your choice to have the system checked.

Oil pressure warning display

N00558700061

Type 1



Type 2



If the engine oil pressure drops while the engine is running, the warning display is displayed on the information screen in the multi-information display.

CAUTION

- If the vehicle is driven while the engine oil is low, or the oil level is normal but the warning is displayed, the engine may overheat and damage may result.
- If the warning is displayed while the engine is running, park your vehicle in a safe place as soon as possible and check the engine oil level.

Combination headlights and dimmer switch

CAUTION

- If this warning display comes on when the engine oil level is proper, have your vehicle checked at an authorized Mitsubishi Motors dealer or a repair facility of your choice.

5

NOTE

- The oil pressure warning display does not show the amount of oil. The oil level must be checked using the dipstick.

Combination headlights and dimmer switch

N00522501847

Headlights

NOTE

- Do not leave the headlights and other lights on for a long period of time when the engine is not running. The battery will run down.

NOTE

- When it rains, or when the vehicle has been washed, the inside of the lens sometimes becomes foggy. This is the same as when window glass mists up on a humid day, and does not indicate a problem. When the light is switched on, the heat will dry out the fog. However, if water collects inside the light, have it checked by an authorized Mitsubishi Motors dealer or a repair facility of your choice.

Rotate the switch to operate the lights.

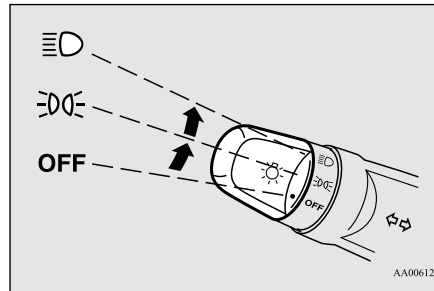

AA0061221

OFF	All lights off
	Parking, tail, front and rear side-marker lights, license plate and instrument panel lights on
	Headlights and other lights on

As your vehicle is equipped with daytime running lights, the combinations of switch operations and illuminated lights differ in accordance with the following conditions.

[When the engine is started after the parking brake is released]

OFF	The daytime running lights illuminated
	The daytime running lights illuminated Parking (vehicles with daytime running lights on the headlights), tail, front and rear side-marker lights, license plate and instrument panel lights on
	Headlights and other lights on



NOTE

- Once the daytime running light come on, they do not go out until the ignition switch is turned to the "LOCK" or "ACC" position.

[When the engine is not running, or when the engine is started before the parking brake is released]

OFF	All lights off
-----	----------------

Combination headlights and dimmer switch



	Parking, tail, front and rear side-marker lights, license plate and instrument panel lights on
	Headlights and other lights on

NOTE

- Even if the daytime running lights are not on, they will come on once the vehicle starts moving.
- Once the daytime running light come on, they do not go out until the ignition switch is turned to the “LOCK” or “ACC” position.

Light auto-cutout function (headlights and other lights)

N00532601623



- If the ignition key is turned to “LOCK” or “ACC” position or removed from the ignition switch and the driver’s door is opened with the light switch in the “” or “” position, the lights automatically turn off.

[When using a key to start the engine]

- If the driver’s door is opened after the key is removed from the ignition switch, a high-pitched constant tone will sound to remind you to turn off the lights.

- If the driver’s door is opened with the key in the ignition switch, a low-pitched tone will sound to remind you to remove the key.



[When using the F.A.S.T.-key to start the engine]

- If the ignition switch is turned to the “LOCK” position and the driver’s door is opened, a high-pitched constant buzzer will sound to remind you to turn off the lights.
- If the ignition switch is turned to any position other than “LOCK” and the driver’s door is opened, a low-pitched constant buzzer will sound to remind you to return the ignition switch.
- If the ignition switch is turned to “LOCK” or “ACC” position with the driver’s door closed and the light switch in the “” or “” position, the lights will stay on for about 3 minutes and then turn off automatically.

NOTE

- The light auto-cutout function can be deactivated. See your authorized Mitsubishi Motors dealer for details.

When you want to keep the lights on:

If the light switch is turned to the “” or “” position again after the engine is turned off, the about 3 minutes auto-cutout function described above will not work. The lights (the parking lights, tail lights and license plate lights) will stay on and will not turn off automatically.

5

NOTE

- When the engine is started using the key, if the driver’s door is opened and the key is removed, the headlight reminder buzzer intermittently emits a high-pitched sound. If the key is still in the ignition the key reminder buzzer intermittently emits a low-pitched sound. The buzzer stops when the driver’s door is closed. (A warning is also displayed in the multi-information display.)

Combination headlights and dimmer switch

NOTE

- When the engine is started using the F.A.S.T.-key, if the driver's door is opened and the ignition switch is in the "LOCK" position, the headlight reminder buzzer intermittently emits a high-pitched sound. If the ignition switch is in any position other than "LOCK", the ignition switch on reminder buzzer intermittently emits a low-pitched sound.

The buzzer stops when the driver's door is closed. (A warning is also displayed in the multi-information display.)

5

Headlight reminder buzzer

N00549800167

When using a key to start the engine

If the driver's door is opened with the key in the "LOCK" or "ACC" position or removed from the ignition switch while the lights are on, the buzzer will sound to remind you to turn off the lights.

When using the F.A.S.T.-key to start the engine

If the driver's door is opened with the ignition switch in the "LOCK" or "ACC" position, or

if the ignition switch is moved to the "LOCK" position while the lights are on, the buzzer will sound to remind you to turn off the lights.

In either case, the lights and buzzer will turn off automatically.

Or you can turn the light switch to the "OFF" position to stop the buzzer.

Dimmer (high/low beam change)

N00549900155

To change the headlights from high beam to low beam and vice versa, pull the turn signal lever to fully toward you (1). Switch the headlights to low beam as a courtesy whenever there are oncoming vehicles, or when there is traffic moving ahead of you. An illuminated blue light in the instrument cluster indicates when the headlights are on high beam.

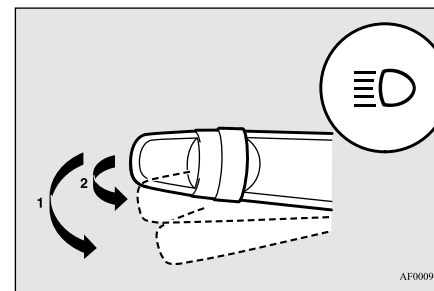

AF0009413

Headlight flasher

N00550000156

You can flash the high beams by pulling the lever gently toward you (2). The lights will go back to normal when you let go. While the high beam is on, you will see a blue light on the instrument panel.

NOTE

- You can flash the high beams by pulling the lever toward you, even if the light switch is off.
- If you turn the lights off with the headlights set to high-beam illumination, the headlights are automatically returned to their low-beam setting when the light switch is next turned to the "D" position.

Welcome light

N00563201175

This function turns on the front side-marker and parking lights for about 30 seconds after the UNLOCK button (A) on the remote control transmitter is pressed when the combination headlights and dimmer switch is in the “OFF” position.

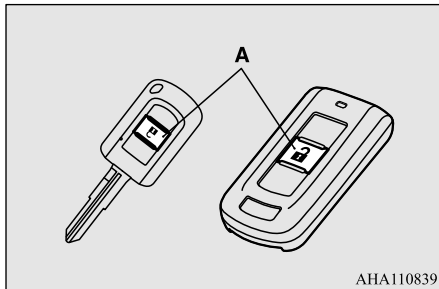

NOTE

- While the welcome light function is operating, perform one of the following operations to cancel the function.

NOTE

- Push the LOCK button (B) on the remote control transmitter.

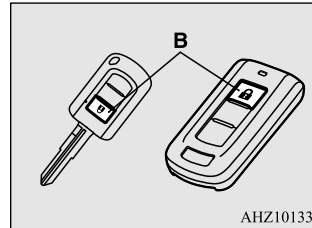

- Turn the combination headlights and dimmer switch to the “ ” or “ ” position.
 - Turn the ignition switch to the “ON” position.
 - It is possible to modify functions as follows:
 - The headlights can be set to come on in the low beam setting.
 - The welcome light function can be deactivated.
- For details, consult a Mitsubishi Motors dealer.

Coming home light

N00547301152

This function turns on the headlights in the low beam setting for about 30 seconds after the ignition switch is turned to the “LOCK” position.

1. Turn the combination headlights and dimmer switch to the “OFF” position.

Combination headlights and dimmer switch

2. Turn the ignition switch to the “LOCK” position. Also, if a key was used to start the engine, remove the key from the ignition switch.
3. Within 60 seconds of turning the ignition switch to the “LOCK” position, pull the turn signal lever toward you.

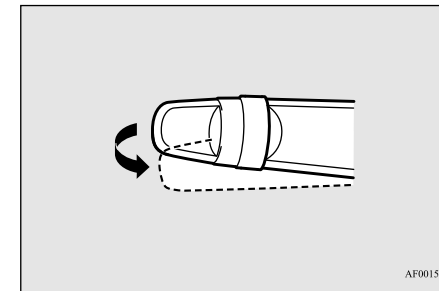



5

4. The headlights will come on in the low beam setting for about 30 seconds. After the headlights go off, the headlights can be turned on again in the low beam setting for about 30 seconds by pulling the turn signal lever toward you within 60 seconds of turning the ignition switch to the “LOCK” position. To turn on the headlights again after 60 seconds of turning the ignition switch to the “LOCK” position, repeat the process from step 1.

5

Turn signal lever

NOTE

- While the coming home light function is operating, perform one of the following operations to cancel the function.
 - Pull the turn signal lever toward you.
 - Turn the combination headlights and dimmer switch to the “ ” or “ ” position.
 - Turn the ignition switch to the “ON” position.
- It is possible to modify functions as follows:
 - The time that the headlights remain on can be changed.
 - The coming home light function can be deactivated.

For details, consult a Mitsubishi Motors dealer.

Turn signal lever

N00522601561

When changing lanes, or to making a gradual turn, hold the lever in the “lane change” position (1). It will return to the neutral position when you let go. Use the full position (2) when making a normal turn. The lever will return to the neutral position when the turn is complete. There may be times when the lever does not return to the neutral position. This usually happens when the steering wheel is turned only slightly. You can easily return the lever by hand.

Also, when you move the lever to (1) slightly then release it, the turn signal lights and indicator light in the instrument cluster will flash three times.

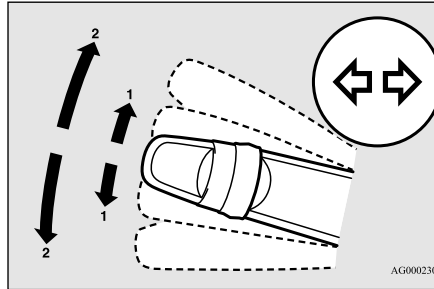

NOTE

- A light in the instrument panel flashes to show when the front and rear turn signal lights are working properly.
 - If this light flashes faster than usual, check for a burned out light bulb or malfunctioning connection.
 - If the panel light does not come on when the lever is moved, check for a blown fuse or a burned out bulb in the panel.
 - Have the vehicle inspected by an authorized Mitsubishi Motors dealer or a repair facility of your choice.
- It is possible to modify functions as follows:
 - Deactivate the turn signal light 3-flash function for lane changes.

NOTE

- Adjust the time required to operate the lever for the 3-flash function. See your authorized Mitsubishi Motors dealer for details.

Hazard warning flasher switch

N00522700233

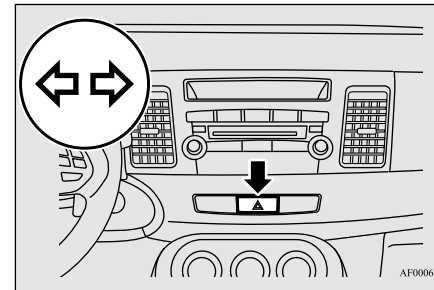

If you press the flasher switch, the front and rear turn signals will flash intermittently, and so will the hazard warning lights. This is an emergency warning system and should not be used when the vehicle is in motion, except for emergencies.

If you need to leave your vehicle, the flashers will keep working after the ignition switch is turned off.

NOTE

- If you keep the flashers on for several hours with the engine turned off, the battery will run down.

Front fog light switch (if so equipped)

N00522800407

The front fog lights illuminate only when the headlights are on low beam.

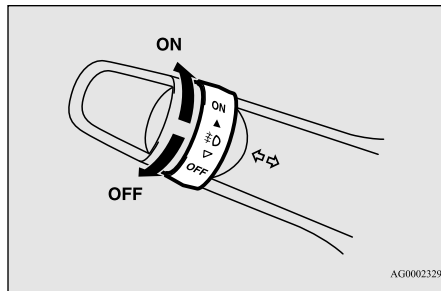

Turning the knob in the direction of the “ON” position turns on the front fog lights as well as the indicator in the instrument cluster. To turn them off, turn the knob in the direction of the “OFF” position.

The knob will return to the neutral position when it is released.



AG0002329

NOTE

- If the headlights are switched to high beam, the front fog lights will go out; they will illuminate again when the headlights are switched back to low beam.
- If the light switch is rotated to the “OFF” or “” position while the front fog lights are illuminated, they will automatically turn off. They can be turned back on again by rotating the light switch back to “” position, and turning the knob in the direction of the “ON” position.
- Do not use fog lights except in conditions of fog, otherwise excessive light glare may temporarily blind oncoming vehicle drivers.

Wiper and washer switch

N00523000611

CAUTION

- If the washer is used in cold weather, the washer fluid sprayed against the glass may freeze, which may hinder visibility. Warm the glass with the defroster before using the washer.

Front fog light switch (if so equipped)

Windshield wipers

N00542901036

NOTE

- To ensure a clear rearward view, the rear window wiper will automatically perform several continuous operations if the gearshift lever or the selector lever is put in the “R” position while the windshield wipers are operating. Refer to “Rear window wiper and washer” on page 5-127.

5

The windshield wiper and washer can be operated with the ignition switch in the “ON” or “ACC” position.

If the blades are frozen to the windshield, do not operate the wipers until the ice has melted and the blades are freed, otherwise the wiper motor may be damaged.

Wiper and washer switch

5

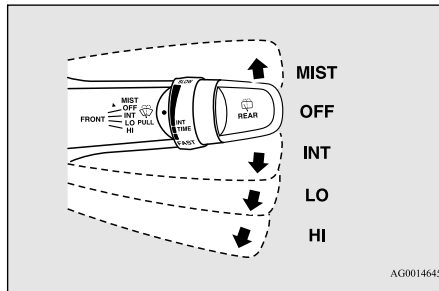

- MIST- Misting function
The wipers will operate once.
- OFF- Off
- INT- Intermittent (Speed sensitive)
- LO- Slow
- HI- Fast

To adjust intermittent intervals

With the lever in the “INT” (speed sensitive intermittent operation) position, the intermittent intervals can be adjusted by turning the knob (A).

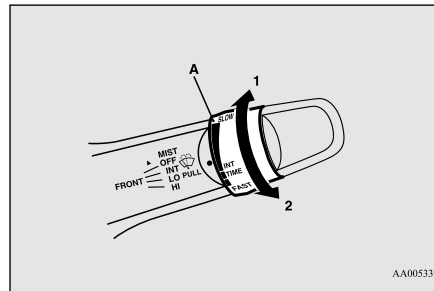

- 1- Fast
- 2- Slow

NOTE

- The speed-sensitive-operation function of the windshield wipers can be deactivated. For further information, please contact your authorized Mitsubishi Motors dealer or a repair facility of your choice.

Misting function

The misting function can be used when the ignition switch is in the “ON” or “ACC” position.

The wipers will operate once if the wiper lever is raised to the “MIST” position and released. This operation is useful when it is drizzling, etc. The wipers will continue to operate while the lever is held in the “MIST” position.

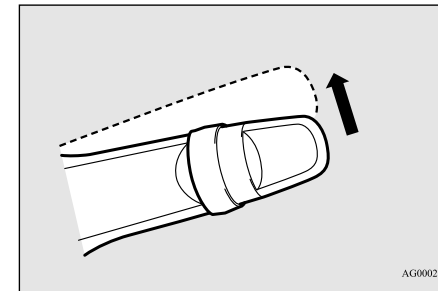

Windshield washer

N00504601367

To turn on the windshield washer, pull the lever toward you with the ignition switch in either the “ON” or “ACC” position. The washer fluid will be sprayed onto the windshield by pulling the lever toward you. When the wipers are not in operation or in intermittent operation, by pulling the lever toward you, the wipers will operate several times while the washer fluid is being sprayed.

Wiper and washer switch

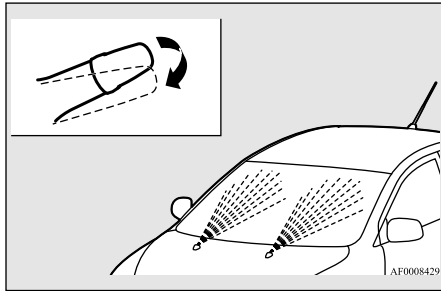

several times while the wipers are operating several times.
Intelligent washer will stop operating with any operation of the lever.

Rear window wiper and washer

N00523201434

The rear window wiper and washer can be operated when the ignition switch is in the “ON” or “ACC” position.

Turn the knob to operate the rear window wiper.

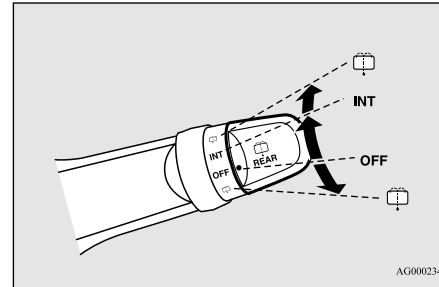

OFF- Off

INT- The wiper operates continuously for several seconds then operates intermittently at intervals of about 8 seconds.

- ☐ Washer fluid will be sprayed onto the rear window glass while the knob is turned fully in either direction.
When the washer fluid is sprayed, the wiper will automatically operate 2 or 3 times.

NOTE

- The rear window wiper will automatically perform several continuous operations if the gearshift lever or the selector lever is put in the “R” position while the windshield wipers or the rear window wiper is operating. (automatic operation mode)

After the automatic operation, the rear window wiper will stop operating if the knob is in the “OFF” position. If the knob is in the “INT” position, the rear window wiper will return to the intermittent operation.

It is possible to set the rear window wiper to perform the automatic operation only if the gearshift lever or the selector lever is put in the “R” position while the rear window wiper is operating with the knob in the “INT” position.

See your authorized Mitsubishi Motors dealer for details.

- If the knob is in the “OFF” position, turn the knob to the “INT” position twice quickly to operate the rear window wiper continuously. (continuous operation mode)
Turn the knob to the “OFF” position to stop the rear window wiper continuous operation.

5

NOTE

- It is possible to modify function so that the wipers cannot be operated when the washer fluid is sprayed. For details, consult an authorized Mitsubishi Motors dealer.
- It is possible to modify functions as follows:
 - Intelligent washer can be activated.
Refer to “Intelligent washer” on page 5-127
 - The wipers can be set to operate again after about 6 seconds.

These functions are not activated when the vehicle is shipped from the factory. To activate or deactivate these functions, please contact your authorized Mitsubishi Motors dealer.

Intelligent washer

By releasing the lever soon after pulling it toward you, the washer fluid will be sprayed

Electric rear window defogger switch

5

NOTE

- The wiper intermittent operation time can be adjusted. See your authorized Mitsubishi Motors dealer for details.
- The washer fluid reservoir is located in the engine compartment. Check the fluid level regularly and refill if necessary. (Refer to “Washer fluid” on page 9-10.)

Precautions to observe when using wipers and washers

N00523501280

CAUTION

- If the washer is used in cold weather, the washer fluid sprayed onto the glass might freeze, blocking your view. In cold weather, heat the glass with the defroster before using the washer.

NOTE

- Do not use the wipers when the windshield is dry. This could scratch the glass and wear the wiper blades prematurely.
- Before using the wipers in cold weather, check to be sure that the wiper blades are not frozen to the windshield. Using the wipers while the blades are frozen could cause the wiper motor to burn out.

NOTE

- If the moving wipers become blocked part-way through a sweep by ice or other deposits on the glass, the wipers may temporarily stop operating to prevent the motor from overheating. In this case, park the vehicle in a safe place, turn the ignition switch to the “OFF” position and then remove the ice or other deposits. Because the wipers will start operating again after the wiper motor cools down, check that the wipers operate before using them.
- Avoid using the washer for more than 20 seconds at a time. Do not operate the washer when the fluid reservoir is empty or the pump may fail.
- During cold weather, add a recommended washer solution that will not freeze in the washer reservoir. Otherwise the washer may not work or may be damaged.
- Replace the wiper blades when they are worn. Use the proper size replacement blades. If you have questions, ask your authorized Mitsubishi Motors dealer.

Electric rear window defogger switch

N00523701439

The electric rear window defogger can be used when the engine is running. The indicator light (A) will come on when you press the electric rear window defogger

switch. Electric current will flow through the heating wires on the rear window to help clear away moisture or frost.

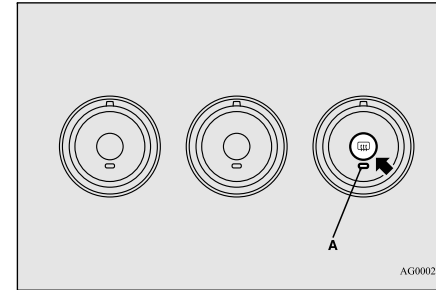

After about 20 minutes of operation, the system will shut off automatically.

To switch the defogger OFF before 20 minutes have passed, press the switch again. The indicator light will go out and the defogger will turn off.

If you need the defogger for more than 20 minutes, press the switch again. This will add 20 more minutes.

CAUTION

- The rear window defogger is not designed to melt snow. Remove any snow manually before using the rear window defogger.

CAUTION

- Use the rear window defogger only after the engine has started and is running. Be sure to turn the defogger switch off immediately after the window is clear to save on battery power.
- Do not place stickers, tape, or other items that are attached with adhesive over the grid wires on the rear window.
- When cleaning the inside rear window, use a soft cloth and wipe lightly over the grid wires.

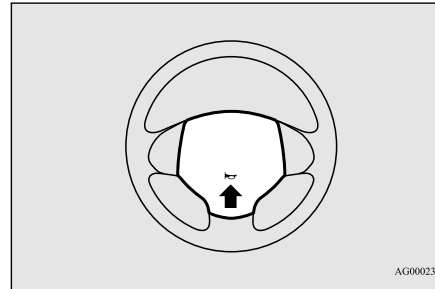

AG0002561

Link System (if so equipped)

N00563701138

The Link System control of the devices connected via the USB input terminal or the Bluetooth® 2.0 interface; the system allows the connected device to be operated by using the switches in the vehicle or voice commands.

See the following section for details on how to operate.

Refer to “Bluetooth® 2.0 interface” on page 5-129.

Refer to “USB input terminal” on page 5-151. Refer to “Listen to Audio Files on a USB Device” on page 7-30.

Refer to “To play iPod/USB memory device tracks via voice operation” on page 7-33.

Horn switch

Refer to “Listen to Bluetooth Audio” on page 7-36.

Bluetooth® is a registered trademark of BLUETOOTH SIG, INC.

Link System End User License Agreement

5

N00563801041

You have acquired a device that includes software licensed to Mitsubishi Motors Corporation from Visteon Corporation, and their subsequent 3rd party suppliers. For a complete list of these 3rd party products and their end user license agreements, please go to the following website.

<http://www.jciblueconnect.com/faq/fulldisclosure.pdf>

Bluetooth® 2.0 interface (if so equipped)

N00563901244

The Bluetooth® 2.0 interface allows for making/receiving hands-free calls in the vehicle using a Bluetooth® compatible cellular phone based on the wireless communication technology commonly known as Bluetooth®. It also allows the user to play music, saved in a

Horn switch

N00523801212

To honk the horn, press around the “HORN” mark on the steering wheel.

Features and controls 5-129

Bluetooth® 2.0 interface (if so equipped)

Bluetooth® music player, from the vehicle's speakers.

The system is equipped with a voice recognition function, which allows you to make hands-free calls by simple switch operations and voice command operations using a defined voice tree.

5

The Bluetooth® 2.0 interface can be used when the ignition switch is in the "ON" or "ACC" position.

Before you can use the Bluetooth® 2.0 interface, you must pair the Bluetooth® device and Bluetooth® 2.0 interface. Refer to "Connecting the Bluetooth® 2.0 interface and Bluetooth® device" on page 5-135.

Bluetooth® is a registered trademark of BLUETOOTH SIG, INC.

WARNING

- Although the Bluetooth® 2.0 interface allows you to make hands-free calls, if you choose to use the cellular phone while driving, you must not allow yourself to be distracted from the safe operation of your vehicle. Anything, including cellular phone usage, that distracts you from the safe operation of your vehicle increases your risk of an accident.

5-130 Features and controls

WARNING

- Refer to and comply with all state and local laws in your area regarding cellular phone usage while driving.

NOTE

- If the ignition switch is left in the "ACC" position, the accessory power will automatically turn off after a certain period of time and you will no longer be able to use the Bluetooth® 2.0 interface. The accessory power comes on again if the ignition switch is turned from the "ACC" position. Refer to "ACC power auto-cutout function" on page 5-52.
- The Bluetooth® 2.0 interface cannot be used if the Bluetooth® device has a dead battery or the device power is turned off.
- Hands-free calls will not be possible if your phone does not have service available.
- Some Bluetooth® devices are not compatible with the Bluetooth® 2.0 interface.
- You can confirm the Link System software version by pressing the HANG-UP button 3 times (press and hold 2 times and then press briefly) within 10 seconds.

NOTE

- For detail of the Bluetooth® 2.0 interface, refer to the following website:
[For vehicles sold in U.S.A.]
You can access the Mitsubishi Motors North America website.
[For vehicles sold in Canada]
You can access the Mitsubishi Motors website.
Please read and agree to the "Warning about Links to the Web Sites of Other Companies", the websites mentioned above may connect you to websites other than the Mitsubishi Motors website.
<http://www.mitsubishi-motors.com/en/products/index.html>
- Software updates by cellular phone/digital audio device manufacturers may change/alter device connectivity.

Steering control switch and microphone → P.5-131

Voice recognition function → P.5-132

Useful voice commands → P.5-133

Speaker enrollment function → P.5-134

Connecting the Bluetooth® 2.0 interface and the Bluetooth® device → P.5-135

Operating a music player connected via Bluetooth® → P.5-141

How to make or receive hands-free calls → P.5-141

Phonebook function → P.5-144

Steering control switch and microphone

N00564001154

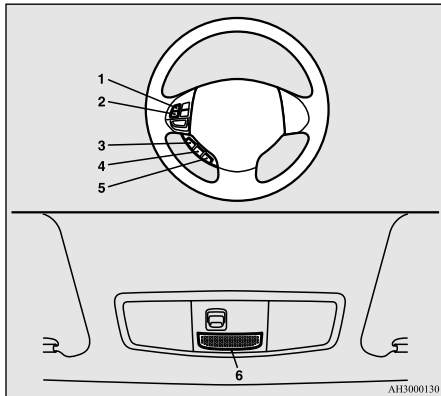

- 1- Volume up button
- 2- Volume down button
- 3- SPEECH button
- 4- PICK-UP button
- 5- HANG-UP button
- 6- Microphone

Volume up button

Press this button to increase the volume.

Volume down button

Press this button to decrease the volume.

SPEECH button

- Press this button to change to voice recognition mode.
While the system is in voice recognition mode, “Listening” will appear on the audio display.
- If you press the button briefly while in voice recognition mode, it will interrupt prompting and allow voice command input.
Pressing the button longer will deactivate the voice recognition mode.
- Pressing this button briefly during a call will enable voice recognition and allow voice command input.

PICK-UP button

- Press this button when an incoming call is received to answer the telephone.
- When another call is received during a call, press this button to put the first caller on hold and talk to the new caller.

Bluetooth® 2.0 interface (if so equipped)

- In such circumstances, you can press the button briefly to switch between callers. You will switch to the first caller and the other caller will be put on hold.
- To establish a three-way call in such situations, press the SPEECH button to enter voice recognition mode and then say “Join calls.”

5

HANG-UP button

- Press this button when an incoming call is received to refuse the call.
- Press this button during a call to end the current call.
When another call is on hold, you will switch to that call.
- If this button is pressed in the voice recognition mode, the voice recognition mode will be deactivated.

NOTE

- When you press the SPEECH button to enter voice recognition mode with a cellular phone paired to the system, current information on the cellular phone, such as “remaining battery life,” “signal strength” or “roaming,” will be displayed on the audio display.*
*: Some cellular phones will not send this information to the Bluetooth® 2.0 interface.

Bluetooth® 2.0 interface (if so equipped)

NOTE

- Call waiting and three-way calls can be used by the Bluetooth® 2.0 interface, only if it is possible to use those services with your cellular phone.

5 Microphone

N00575800025

Your voice will be recognized by a microphone in the overhead console, allowing you to make hands-free calls with voice commands.

NOTE

- If a cellular phone is within close proximity of the microphone, it may distort the sound quality. In this case, place the cellular phone as far as possible from the microphone.

Voice recognition function

N00564101142

The Bluetooth® 2.0 interface is equipped with a voice recognition function.

Simply say voice commands and you can perform various operations and make or receive hands-free calls.

With the Bluetooth® 2.0 interface, voice recognition is possible for US English, North

American Spanish, Canadian French and Japanese. The factory setting is “English.”

NOTE

- If the voice command that you say differs from the predefined command or cannot be recognized due to ambient noise or some other reason, the Bluetooth® 2.0 interface will ask you for the voice command again up to 3 times.
- For best performance and further reduction of ambient noise, the vehicle windows should be closed, lower the blower speed and refrain from conversation with your passengers while engaging the voice recognition function.
- Some voice commands have alternative commands.
- Depending on the selected language, some functions may not be available.

Selecting the language

1. Press the SPEECH button.
2. Say “Setup.”
3. Say “Language.”
4. The voice guide will say “Select a language: English, Spanish, French or Japanese.” Say the desired language. (Example: “English”)

5. The voice guide will say “English (Spanish, French or Japanese) selected. Is this correct?” Say “Yes.”

If you say “No,” the system will return to Step 4.

NOTE

- The voice guide will repeat the same message twice. The first message is in the current language, and the second message is in the selected language.
- If many entries are registered in the vehicle phonebook, changing the language will take a longer time.
- Changing the language deletes the mobile phonebook imported to the Bluetooth® 2.0 interface. If you wish to use it, you will have to import it again.

6. When the voice guide says “English (Spanish, French or Japanese) selected,” the language change process will be completed and the system will return to the main menu.

Useful voice commands

N00564200016

Help function

N00564300017

The Bluetooth® 2.0 interface is equipped with a help function.

If you say “Help” when the system is waiting for a voice command input, the system will tell you a list of the commands that can be used under the circumstances.

Canceling

N00564401044

There are 2 cancel functions.

If you are at the main menu, say “Cancel” to exit from the Bluetooth® 2.0 interface.

If you are anywhere else within the system, say “Cancel” to return to the main menu.

NOTE

- You can return to the previous menu by saying “Go Back.” (if so equipped)

Confirmation function setting

N00564501058

The Bluetooth® 2.0 interface is equipped with a confirmation function.

With the confirmation function activated, you are given more opportunities than normal to confirm a command when making various settings to the Bluetooth® 2.0 interface. This allows you to decrease the possibility that a setting is accidentally changed.

The confirmation function can be turned on or off by following the steps below.

1. Press the SPEECH button.
2. Say “Setup.”
3. Say “Confirmation prompts.”
4. The voice guide will say “Confirmation prompts are <on/off>. Would you like to turn confirmation prompts <off/on>.” Answer “Yes” to change the setting or answer “No” to keep the current setting.
5. The voice guide will say “Confirmation prompts are <off/on>” and then the system will return to the main menu.

Security function

N00564601147

It is possible to use a passcode as a security function by setting a passcode of your choice for the Bluetooth® 2.0 interface.

When the security function is turned on, it is necessary to make a voice input of a 4-digit passcode in order to use all functions of the Bluetooth® 2.0 interface, except for reception.

Bluetooth® 2.0 interface (if so equipped)

Setting the passcode

Use the following procedure to turn on the security function by setting a passcode.

1. Press the SPEECH button.
2. Say “Setup.”
3. Say “Passcode.”
4. The voice guide will say “Passcode is disabled. Would you like to enable it?” Answer “Yes.” Answer “No” to cancel the setting of the passcode and return to the main menu.
5. The voice guide will say “Please say a 4-digit passcode. Remember this passcode. It will be required to use this system.” Say a 4-digit number which you want to set as a passcode.
6. For confirmation purposes, the voice guide will say “Passcode <4-digit passcode>. Is this correct?” Answer “Yes.” Answer “No” to return to the passcode input in Step 5.
7. When the registration of the passcode is completed, the voice guide will say “Passcode is enabled” and the system will return to the main menu.

5

NOTE

- Passcode will be required to access the system after the next ignition cycle.

Bluetooth® 2.0 interface (if so equipped)

5

NOTE

- It is required for a little time after engine stop that the entered passcode is actually recorded in the system. If the ignition switch is made to “ACC” or “ON” or the engine is started immediately after engine stop, there is a case when the entered passcode is not recorded in the system. At this time, please try to enter the passcode again.

Entering the passcode

If a passcode has been set and the security function is enabled, the voice guide will say “Hands-free system is locked. State the passcode to continue” when the SPEECH button is pressed to enter voice recognition mode. Say the 4-digit passcode number to enter the passcode.

If the entered passcode is wrong, the voice guide will say “<4-digit passcode>, Incorrect passcode. Please try again.” Enter the correct passcode.

NOTE

- You can reenter the passcode as many times as you want.
- If you have forgotten your passcode, say “Cancel” to quit the voice input mode and then check with an authorized Mitsubishi Motors dealer.

5-134 Features and controls

Disabling the passcode

Use the following procedure to turn off the security function by disabling the passcode.

NOTE

- System must be unlocked to disable the passcode.

1. Press the SPEECH button.
2. Say “Setup.”
3. Say “Passcode.”
4. The voice guide will say “Passcode is enabled. Would you like to disable it?” Answer “Yes.”
Answer “No” to cancel the disabling of the passcode and return to the main menu.
5. When the disabling of the passcode is completed, the voice guide will say “Passcode is disabled” and the system will return to the main menu.

Speaker enrollment function

N00564700011

The Bluetooth® 2.0 interface can use the speaker enrollment function to create a voice model for one person per language.

This makes it easier for the Bluetooth® 2.0 interface to recognise voice commands said by you.

You can turn a voice model registered with the speaker enrollment function on and off whenever you want.

Speaker enrollment

N00564801136

It takes about 2 to 3 minutes to complete the speaker enrollment process.

To ensure the best results, run through the process while in the driver’s seat, in an environment that is as quiet as possible (when there is no rain or strong winds and the vehicle windows are closed). Please turn off your phone while in speaker enrollment to prevent interruption of the process.

Use the following procedure for speaker enrollment.

1. Stop your vehicle in a safe area, put the gearshift lever (manual transaxle) in the “N” (Neutral) position, or the selector lever {continuously variable transmission (CVT)} in the “P” (PARK) position, and then pull the parking brake lever.

NOTE

- Speaker enrollment is not possible unless the vehicle is parked. Make sure you park the vehicle in a safe area before attempting speaker enrollment.

2. Press the SPEECH button.

3. Say "Voice training."
4. The voice guide will say "This operation must be performed in a quiet environment while the vehicle is stopped. See the owner's manual for the list of required training phrases. Press and release the SPEECH button when you are ready to begin. Press the HANG-UP button to cancel at any time."
Press the SPEECH button to start the speaker enrollment process.

NOTE

- If you do not start the speaker enrollment process within 3 minutes after pressing the SPEECH button, the speaker enrollment function will time out.
The voice guide will say "Speaker enrollment has timed out." The system will then beep and the voice recognition mode will be deactivated.

5. The voice guide will prompt for phrase 1. Repeat the corresponding phrase listed in table "Enrollment commands" on page 5-151.
The system will register your voice and then move on to the registration of the next command. Continue the process until all phrases have been registered.

NOTE

- To repeat the most recent voice training command, press and release the SPEECH button.
- If you press the HANG-UP button anytime during the process, the system will beep and stop the speaker enrollment process.

6. When all enrollment commands have been read out, the voice guide will say "Speaker enrollment is complete." The system will then end the speaker enrollment process and return to the main menu.

NOTE

- Completing the speaker enrollment process will turn on the voice model automatically.
- The commands "Help" and "Cancel" will not work in this mode.

Enabling and disabling the voice model and retraining

N00564901094

You can turn a voice model registered with the speaker enrollment function on and off whenever you want.
You can also retrain the system.
Use the following procedure to perform these actions.

1. Press the SPEECH button.

Bluetooth® 2.0 interface (if so equipped)

2. Say "Voice training."
3. If you have completed a speaker enrollment process once already, the voice guide will say either "Enrollment is enabled. Would you like to disable or retrain?" or "Enrollment is disabled. Would you like to enable or retrain?"
4. When enrollment is "enabled," the voice model is on; when enrollment is "disabled," the voice model is off. Say the command that fits your needs.
Say "Retrain" to start the speaker enrollment process and recreate a new voice model. (Refer to "Speaker enrollment" on page 5-134.)

5

Connecting the Bluetooth® 2.0 interface and Bluetooth® device

N00565001308

Before you can make or receive hands-free calls or play music using the Bluetooth® 2.0 interface function, you must pair the Bluetooth® device and Bluetooth® 2.0 interface.

Bluetooth® 2.0 interface (if so equipped)

5

NOTE

- Pairing is required only when the device is used for the first time. Once the device has been paired with the Bluetooth® 2.0 interface, all you need is to bring the device into the vehicle next time and the device will connect to the Bluetooth® 2.0 interface automatically (if supported by the device).

Up to 7 Bluetooth® devices can be paired with the Bluetooth® 2.0 interface.

If multiple paired Bluetooth® devices are available in the vehicle, the cellular phone or music player most recently connected is automatically connected to the Bluetooth® 2.0 interface.

You can also change a Bluetooth® device to be connected.

To pair

To pair a Bluetooth® device with the Bluetooth® 2.0 interface, use either one of the following 2 methods (Type 1 or Type 2).

■ Pairing procedure- Type 1 (if so equipped)

1. Stop your vehicle in a safe area, put the gearshift lever (manual transaxle) in the “N” (Neutral) position, or the selector lever {continuously variable transmission (CVT)} in the “P” (PARK) position, and then pull the parking brake lever.

NOTE

- You cannot pair any Bluetooth® device with the Bluetooth® 2.0 interface unless the vehicle is parked. Before pairing a Bluetooth® device with the Bluetooth® 2.0 interface, confirm that the vehicle is parked in a safe location.

2. Press the SPEECH button.
3. Say “Setup.”
4. Say “Pairing Options.”
5. The voice guide will say “Select one of the following: pair, edit, delete, or list.” Say “Pair.”

NOTE

- If 7 devices have already been paired, the voice guide will say “Maximum devices paired” and then the system will end the pairing process. To register a new device, delete one device and then repeat the pairing process. (Refer to “Selecting a device: Deleting a device” on page 5-139.)

6. The voice guide will say “Please say a 4-digit pairing code.” Say a 4-digit number. When the confirmation function is on, the system will confirm whether the number said is acceptable. Answer “Yes.” Answer “No” to return to pairing code selection.

NOTE

- Some Bluetooth® devices require a specific pairing code. Please refer to the device manual for pairing code requirements.

Bluetooth® 2.0 interface (if so equipped)

 **NOTE**

- The pairing code entered here is only used for the Bluetooth® connection certification. It is any 4-digit number the user would like to select.
Remember the pairing code as it needs to be keyed into the Bluetooth® device later in the pairing process.
Depending on the connection settings of the Bluetooth® device, this code may have to be entered each time you connect the Bluetooth® device to the Bluetooth® 2.0 interface. For the default connection settings, refer to the instructions for the device.

- The voice guide will say “Start pairing procedure on the device. See the device manual for instructions.” Enter in the Bluetooth® device the 4-digit number you have registered in Step 6.

 **NOTE**

- Depending on the Bluetooth® device, it may take a few minutes to pair it with the Bluetooth® 2.0 interface.
- If the Bluetooth® 2.0 interface cannot recognize the Bluetooth® device, the voice guide will say “Pairing has timed out” and the pairing process will be cancelled.
Confirm that the device you are pairing supports Bluetooth®, and try pairing it again.

 **NOTE**

- If you enter the wrong number, the voice guide will say “Pairing failed” and the pairing process will be cancelled.
Confirm the number is right, and try pairing it again.

- The voice guide will say “Please say the name of the device after the beep.” You can assign a desired name for the Bluetooth® device and register it as a device tag. Say the name you want to register after the beep.

 **NOTE**

- When the confirmation function is on, after repeating the device tag you have said, the voice guide will ask “Is this correct?” Answer “Yes.”
To change the device tag, answer “No” and then say the device tag again.

- The voice guide will say “Pairing complete,” and the pairing process will end.

■ **Pairing procedure- Type 2 (if so equipped)**

- Stop your vehicle in a safe area, put the shift lever (manual transaxle) in the “N” (Neutral) position, or the selector lever {continuously variable transmission (CVT)} in the “P” (PARK) position and pull the parking brake lever.

5 **NOTE**

- You cannot pair any Bluetooth® device with the Bluetooth® 2.0 interface unless the vehicle is parked. Before pairing a Bluetooth® device with the Bluetooth® 2.0 interface, confirm that the vehicle is parked in a safe location.

- Press the SPEECH button.
- Say “Pair Device.”

Bluetooth® 2.0 interface (if so equipped)

5

 **NOTE**

- The following procedure (① to ③) can also be used instead of saying “Pair Device.” Replace this step 3 with the following procedure if you prefer.

① Say “Setup.”

② Say “Pairing Options.”

③ The voice guide will say “Select one of the following: pair, edit, delete, list or set code.”

Say “Pair.”

- If 7 devices have already been paired, the voice guide will say “Maximum devices paired” and then the system will end the pairing process. To register a new device, delete one device and then repeat the pairing process. (Refer to “Selecting a device: Deleting a device” on page 5-139.)

4. The voice guide will say “Start pairing procedure on the device. See the device manual for instructions.” and then will say “The pairing code is <pairing code>.”

 **NOTE**

- Some Bluetooth® devices require a specific pairing code. Please refer to the device manual for pairing code requirements and read the next section “If your device requires a specific pairing code” on page 5-139 to set the pairing code.

 **NOTE**

- The pairing code entered here is only used for the Bluetooth® connection certification. Depending on the connection settings of the Bluetooth® device, this code may have to be entered each time you connect the Bluetooth® device to the Bluetooth® 2.0 interface. For the default connection settings, refer to the instructions for the device.

5. Enter in the Bluetooth® device the 4-digit number that has been read out in Step 4.

 **NOTE**

- Depending on the Bluetooth® device, it may take a few minutes to pair it with the Bluetooth® 2.0 interface.
- If the Bluetooth® 2.0 interface cannot recognize the Bluetooth® device, the voice guide will say “Pairing has timed out” and the pairing process will be cancelled. Confirm that the device you are pairing supports Bluetooth®, and try pairing it again.

 **NOTE**

- If you enter the wrong number, the voice guide will say “Pairing failed” and the pairing process will be cancelled. Confirm the number is right, and try pairing it again. If your device requires a specific pairing code, you need to set the pairing code. Refer to the device manual for pairing code requirements and read the next section “If your device requires a specific pairing code” on page 5-139.

6. The voice guide will say “Please say the name of the device after the beep.” You can assign a desired name for the Bluetooth® device and register it as a device tag. Say the name you want to register after the beep.

 **NOTE**

- When the confirmation function is on, after repeating the device tag you have said, the voice guide will ask “Is this correct?” Answer “Yes.” To change the device tag, answer “No” and then say the device tag again.

- The voice guide will say “Pairing Complete. Would you like to import the contacts from your mobile device now?” Answer “Yes,” and the voice guide will say “Please wait while the contacts are imported. This may take several minutes.” Answer “No” to end the pairing process.

If your device requires a specific pairing code

If your device requires a specific pairing code, you need to set the pairing code. Follow the procedures below.

- Press the SPEECH button.
- Say “Setup.”
- Say “Pairing Options.”
- Say “Set Code.”
- The voice guide will say “Do you want the pairing code to be random or fixed?” Say “Fixed.”
- The voice guide will say “Please say a 4-digit pairing code.” Say a 4-digit number.
- The voice guide will say “Pairing code set to <pairing code>.”

When the confirmation function is on, the system will confirm whether the number said is acceptable. Answer “Yes.” Answer “No,” the system will return to Step 6.

- The voice guide will say “Do you want to pair a device now?” Answer “Yes,” the system will proceed to Step 3 in the pairing process. Refer to the “Pairing procedure- Type 2.”

Selecting a device

N00565101107

If multiple paired Bluetooth® devices are available in the vehicle, the cellular phone or music player most recently connected is automatically connected to the Bluetooth® 2.0 interface.

You can connect to the other cellular phone or music player by following setting change procedures.

To select a cellular phone

- Press the SPEECH button.
- Say “Setup.”
- Say “Select phone.”
- After the voice guide says “Please say,” the numbers of the cellular phones and device tags of corresponding cellular phones will be read out in order, starting with the cellular phone that has been most recently connected.
Say the number of the cellular phone that you want to connect to.

Bluetooth® 2.0 interface (if so equipped)

When the confirmation function is on, the system will ask you again whether the phone that you want to connect to is correct. Answer “Yes” to continue and connect to the cellular phone.

Answer “No,” and the voice guide will say “Please say.” Say the number of the phone that you want to connect to.

5

NOTE

- You can connect to a phone at any time by pressing the SPEECH button and saying the number, even before all of the paired numbers and device tags of corresponding cellular phones are read out by the system.

- The selected phone will be connected to the Bluetooth® 2.0 interface. The voice guide will say “<device tag> selected” and then the system will return to the main menu.

To select a music player

- Press the SPEECH button.
- Say “Setup.”
- Say “Select music player.”

Bluetooth® 2.0 interface (if so equipped)

5

4. After the voice guide says “Please say,” the numbers of the music players and device tags of corresponding music players will be read out in order, starting with the music player that has been most recently connected.

Say the number of the music player that you want to connect to.

When the confirmation function is on, the system will ask you again whether the music player that you want to connect to is correct. Answer “Yes” to continue and connect to the music player.

Answer “No,” and the voice guide will say “Please say.” Say the number of the music player that you want to connect to.

NOTE

- You can connect to a music player at any time by pressing the SPEECH button and saying the number, even before all of the paired numbers and device tags of corresponding music players are read out by the system.

5. The selected music player will be connected to the Bluetooth® 2.0 interface.

The voice guide will say “<device tag> selected” and then the system will return to the main menu.

Deleting a device

Use the following procedure to delete a paired Bluetooth® device from the Bluetooth® 2.0 interface.

1. Press the SPEECH button.
2. Say “Setup.”
3. Say “Pairing Options.”
4. The voice guide will say “Select one of the following: pair, edit, delete, or list.” Say “Delete.”
5. After the voice guide says “Please say,” the numbers of the devices and device tags of corresponding devices will be read out in order, starting with the device that has been most recently connected. After it completes reading all pairs, the voice guide will say “or all.” Say the number of the device that you want to delete from the system. If you want to delete all paired phones from the system, say “All.”
6. For confirmation purposes, the voice guide will say “Deleting <device tag> <number>. Is this correct?” or “Deleting all devices. Is this correct?” Answer “Yes” to delete the phone(s). Answer “No,” the system will return to Step 4.

7. The voice guide will say “Deleted,” and then the system will end the device deletion process.

NOTE

- If the device deletion process fails for some reason, the voice guide will say “Delete failed” and then the system will cancel deleting the device.

To check a paired Bluetooth® device

N00565201052

You can check a paired Bluetooth® device by following the steps below.

1. Press the SPEECH button.
2. Say “Setup.”
3. Say “Pairing Options.”
4. The voice guide will say “Select one of the following: pair, edit, delete, or list.” Say “List.”
5. The voice guide will read out device tags of corresponding devices in order, starting with the Bluetooth® device that has been most recently connected.
6. After the device tags of all paired Bluetooth® devices have been read, the system will say “End of list, would you like to start from the beginning?”

To hear the list again from the beginning, answer “Yes.”

When you are done, answer “No” to return to the main menu.

NOTE

- If you press and release the SPEECH button and say “Continue” or “Previous” while the list is being read, the system will advance or rewind the list.
Say “Continue” to proceed to the device with the next highest number or “Previous” to return to the phone with the previous number.
- You can change the device tag by pressing and releasing the SPEECH button and then saying “Edit” while the list is being read.
- You can change the phone to be connected by pressing and releasing the SPEECH button and then saying “Select phone” while the list is being read.
- You can change the music player to be connected by pressing and releasing the SPEECH button and then saying “Select music player” while the list is being read.

Changing a device tag

N00565301053

You can change the device tag of a paired cellular phone or music player.

Follow the steps below to change a device tag.

1. Press the SPEECH button.
2. Say “Setup.”
3. Say “Pairing Options.”
4. The voice guide will say “Select one of the following: pair, edit, delete, or list.” Say “Edit.”
5. The voice guide will say “Please say,” and read out the numbers of the Bluetooth® devices and device tags of corresponding devices in order, starting with the Bluetooth® that has been most recently connected.
After all paired device tags have been read, the voice guide will say “Which device, please?” Say the number of the device tag you want to change.

NOTE

- You can press and release the SPEECH button while the list is being read, and immediately say the number of the device tag you want to change.

6. The voice guide will say “New name, please.” Say the name you want to register as a new device tag.

When the confirmation function is on, the voice guide will say “<New device tag>.

Is this correct?” Answer “Yes.”

Answer “No,” you can say the new device tag you want to register again.

7. The device tag is changed.

Bluetooth® 2.0 interface (if so equipped)

When the change is complete, the voice guide will say “New name saved” and then the system will return to the main menu.

Operating a music player connected via Bluetooth®

N00565401113

5

For the operation of a music player connected via Bluetooth®, refer to the following sections.

For vehicles equipped with the AM/FM radio/CD player

Refer to “Listen to Bluetooth Audio” on page 7-36.

For vehicles equipped with the DISPLAY AUDIO

Refer to the separate owner’s manual.

How to make or receive hands-free calls

N00565500074

You can make or receive hands-free calls using a Bluetooth® compatible cellular phone connected to the Bluetooth® 2.0 interface.

Bluetooth® 2.0 interface (if so equipped)

You can also use the phonebooks in the Bluetooth® 2.0 interface to make calls without dialing telephone numbers.

To make a call P.5-142
Send function P.5-143
Receiving calls P.5-144
Mute function P.5-144

5

Switching between hands-free mode and private mode P.5-144

NOTE

- Hands-free calls may not operate correctly when you place or receive the call directly from your cellular phone, instead of using the Bluetooth® 2.0 interface.

To make a call

N00565601115

You can make a call in the following 3 ways using the Bluetooth® 2.0 interface:

- By saying a telephone number
- By using the Bluetooth® 2.0 interface's phonebook
- By redialing a telephone number

Making a call by using the telephone number

You can make a call by saying the telephone number.

1. Press the SPEECH button.
2. Say "Dial."
3. After the voice guide says "Number please," say the telephone number.
4. The voice guide will say "Dialing <number recognized>."

The Bluetooth® 2.0 interface will then make the call.

When the confirmation function is on, the system will confirm the telephone number again. To continue with that number, answer "Yes."

To change the telephone number, answer "No." The system will say "Number please" then say the telephone number again.

NOTE

- In the case of English, the system will recognize both "zero" and "oh" (Letter "o") for the number "0."
- The Bluetooth® 2.0 interface supports numbers (0 to 9) and characters (+, # and *).
- The maximum supported telephone number length is as follows:

NOTE

- International telephone number: + and telephone numbers (to 18 digits).
- Except for international telephone number: telephone numbers (to 19 digits).

Making a call using a phonebook

You can make calls using the vehicle phonebook or mobile phonebook of the Bluetooth® 2.0 interface.

For details on the phonebooks, refer to "Phonebook function" on page 5-144.

1. Press the SPEECH button.
2. Say "Call."

NOTE

- If you say "Call" when the vehicle phonebook and the mobile phonebook are empty, the voice guide will say "The vehicle phonebook is empty. Would you like to add a new entry now?"
Answer "Yes," and the voice guide will say "Entering the phonebook - new entry menu." You can now create data in the vehicle phonebook.
Answer "No," the system will return to the main menu.

3. After the voice guide says “Name please,” say the name you want to call, from those registered in the phonebook.
4. If there is only 1 match, the system will proceed to Step 5.
If there are 2 or more matches, the voice guide will say “More than one match was found, would you like to call <returned name>.” If that person is the one you want to call, answer “Yes.”
Answer “No,” the name of the next matching person will be uttered by the voice guide.

NOTE

- If you say “No” to all names read by the system, the voice guide will say “Name not found, returning to main menu” and the system will return to the main menu.

5. If only 1 telephone number is registered under the name you just said, the voice guide will proceed to Step 6.
If 2 or more telephone numbers are registered that match the name you just said, the voice guide will say “Would you like to call <name> at [home], [work], [mobile], or [other]?” Select the location to call.

NOTE

- If the name you selected has matching data in the vehicle phonebook but no telephone number is registered under the selected location, the voice guide will say “{home/work/mobile/other} not found for <name>. Would you like to add location or try again?”
Say “Try again,” and the system will return to Step 3.
Say “Add location” and you can register an additional telephone number under the selected location.
- If the name you selected has matching data in the mobile phonebook but no telephone number is registered under the selected location, the voice guide will say “{home/work/mobile/other} not found for <name>. Would you like to try again?”
Answer “Yes,” and the system will return to Step 3.
Answer “No,” and the call will be cancelled. Start over again from Step 1.

6. The voice guide will say “Calling <name> <location>” and then the system will dial the telephone number.

Bluetooth® 2.0 interface (if so equipped)

NOTE

- When the confirmation function is on, the system will check if the name and location of the receiver are correct. If the name is correct, answer “Yes.”
To change the name or location to call, answer “No.” The system will return to Step 3.

5

Redialing

You can redial the last number called, based on the history of dialed calls in the paired cellular phone.

Use the following procedure to redial.

1. Press the SPEECH button.
2. Say “Redial.”

Send function

N00565700018

During a call, press the SPEECH button to enter voice recognition mode, then say “<numbers> SEND” to generate DTMF tones.

For example, if during a call you need to simulate the pressing of a phone button as a response to an automated system, press the SPEECH button and speak “1 2 3 4 pound send” and the 1234# will be sent via your cellular phone.



Bluetooth® 2.0 interface (if so equipped)

Receiving calls

N00565800019

If an incoming phone call is received while the ignition switch is in the “ACC” or “ON” position, the audio system will be automatically turned on and switched to the incoming call, even when the audio system was originally off.

5

The voice guide announcement for the incoming call will be output from the front passenger’s seat speaker.

If the CD player or radio was playing when the incoming call was received, the audio system will mute the sound from the CD player or radio and output only the incoming call.

To receive the call, press the PICK-UP button on the steering wheel control switch.

When the call is over, the audio system will return to its previous state.

Mute function

N00565900010

At any time during a call, you can mute the vehicle microphone.

Pressing the SPEECH button and then saying “Mute” during a call will turn ON the mute function and mute the microphone.

Saying “Mute off” in the same way will turn off the mute function and cancel the mute on the microphone.

Switching between hands-free mode and private mode

N00566600014

The Bluetooth® 2.0 interface can switch between hands-free mode (hands-free calls) and private mode (calls using cellular phone). If you press the SPEECH button and say “Transfer call” during a hands-free call, you can stop the hands-free mode and talk in private mode.

To return to hands-free mode, press the SPEECH button again and say “Transfer call.”

Phonebook function

N00566000018

The Bluetooth® 2.0 interface has 2 types of unique phonebooks that are different from the phonebook stored in the cellular phone. They are the vehicle phonebook and the mobile phonebook.

These phonebooks are used to register telephone numbers and make calls to desired numbers via voice recognition function.

NOTE

- Disconnecting the battery cable will not delete information registered in the phonebook.

Vehicle phonebook

N00566101117

This phonebook is used when making calls with the voice recognition function.

Up to 32 names can be registered in the vehicle phonebook per language.

Also, each entry has 4 locations associated with: home, work, mobile and other. You can register one telephone number for each location.

You can register a desired name as a name for any phonebook entry registered in the vehicle phonebook.

Names and telephone numbers can be changed later on.

The vehicle phonebook can be used with all paired cellular phones.

■ To register a telephone number in the vehicle phonebook

N00580500046

You can register a telephone number in the vehicle phonebook in the following 2 ways: Reading out a telephone number, and selecting and transferring 1 phonebook entry from the phonebook of the cellular phone.

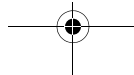

■ To register by reading out a telephone number

N00580600089

1. Press the SPEECH button.
2. Say "Phonebook."
3. The voice guide will say "Select one of the following: new entry, edit number, edit name, list names, delete, erase all, or import contact." Say "New entry."
4. The voice guide will say "Name please." Say your preferred name to register it.

NOTE

- If the maximum number of entries are already registered, the voice guide will say "The phonebook is full. Would you like to delete a name?" Say "Yes" if you want to delete a registered name. If you say "No," the system will return to the main menu.

5. When the name has been registered, the voice guide will say "home, work, mobile, or other?" Say the location for which you want to register a telephone number.

NOTE

- When the confirmation function is on, the voice guide will say "<Location>. Is this correct?" Answer "Yes."
Answer "No" to return to location selection in Step 5.
If a telephone number has been registered for the selected location, the voice guide will say "The current number is <telephone number>, number please."
If you do not want to change the telephone number, say "cancel" or the original number to keep it registered.

6. The voice guide will say "Number please." Say the telephone number to register it.

NOTE

- In the case of English, the system will recognize both "zero" and "oh" (Letter "o") for the number "0."

7. The voice guide will repeat the telephone number you have just read, and then register the number.
When the telephone number has been registered, the voice guide will say "Number saved. Would you like to add another number for this entry?"

Bluetooth® 2.0 interface (if so equipped)

To add another telephone number for a new location for the current entry, answer "Yes." The system will return to location selection in Step 5.

Answer "No" to end the registration process and return to the main menu.

NOTE

- When the confirmation function is on, after repeating the telephone number you have read, the voice guide will ask "Is this correct?" Answer "Yes."
Answer "No" to return to telephone number registration in step 6.

5

■ To select and transfer one phonebook entry from the phonebook of the cellular phone

N00580700064

You can select 1 phonebook entry from the phonebook of the cellular phone and register it in the vehicle phonebook.

NOTE

- Transfer is not permitted unless the vehicle is parked. Before transferring, make sure that the vehicle is parked in a safe location.
- All or part of data may not be transferred, even when the cellular phone supports Bluetooth®, depending on the compatibility of the device.

Bluetooth® 2.0 interface (if so equipped)

5

 **NOTE**

- The maximum supported telephone number length is 19 digits. Any telephone number of 20 digits or more will be truncated to the first 19 digits.
- If telephone numbers contain characters other than 0 to 9, *, # or +, these characters are deleted before the transfer.
- For the connection settings on the cellular phone side, refer to the instructions for the cellular phone.

1. Press the SPEECH button.
 2. Say "Phonebook."
 3. The voice guide will say "Select one of the following: new entry, edit number, edit name, list names, delete, erase all, or import contact." Say "Import contact."
 4. The voice guide will say "Would you like to import a single entry or all contacts?" Say "Single entry."
- The Bluetooth® 2.0 interface will become ready to receive transferred phonebook data.

 **NOTE**

- If the maximum number of entries are already registered, the voice guide will say "The phonebook is full. Would you like to delete a name?" Say "Yes" if you want to delete a registered name. If you say "No," the system will return to the main menu.

5. After the voice guide says "Ready to receive a contact from the phone. Only a home, a work, and a mobile number can be imported," the Bluetooth® 2.0 interface will receive the phonebook data from the Bluetooth® compatible cellular phone.
6. Operate the Bluetooth® compatible cellular phone to set it up so that the phonebook entry you want to register in the vehicle phonebook can be transferred to the Bluetooth® 2.0 interface.

 **NOTE**

- If the Bluetooth® 2.0 interface cannot recognise the Bluetooth® compatible cellular phone or the connection takes too much time, the voice guide will say "Import contact has timed out" and then the system will cancel the registration. In such case, start over again from Step 1.
- Pressing the HANG-UP button or pressing and holding the SPEECH button will cancel the registration.

7. When the reception is complete, the voice guide will say "<Number of telephone numbers that had been registered in the import source> numbers have been imported. What name would you like to use for these numbers?"

Say the name you want to register for this phonebook entry.

 **NOTE**

- If the entered name is already used for other phonebook entry or similar to a name used for other phonebook entry, that name cannot be registered.

8. The voice guide will say "Adding <name>." When the confirmation function is on, the system will ask if the name is correct. Answer "Yes." Answer "No," the voice guide will say "Name please." Register a different name.
9. The voice guide will say "Numbers saved."
10. The voice guide will say "Would you like to import another contact?" Answer "Yes" if you want to continue with the registration. You can continue to register a new phonebook entry from Step 5. Answer "No," the system will return to the main menu.

■ To change the content registered in the vehicle phonebook

N00579800023

You can change or delete a name or telephone number registered in the vehicle phonebook.

You can also listen to the list of names registered in the vehicle phonebook.

NOTE

- The system must have at least one entry.

◆ Editing a telephone number

N00579900079

1. Press the SPEECH button.
2. Say “Phonebook.”
3. The voice guide will say “Select one of the following: new entry, edit number, edit name, list names, delete, erase all, or import contact”. Say “Edit number.”
4. The voice guide will say “Please say the name of the entry you would like to edit, or say list names.” Say the name of the phonebook entry you want to edit.

NOTE

- Say “List names,” and the names registered in the phonebook will be read out in order. Refer to “Vehicle phonebook: Listening to the list of registered names” on page 5-148.

5. The voice guide will say “Home, work, mobile or other?” Select and say the location where the telephone number you want to change or add is registered.

When the confirmation function is on, the system will check the target name and location again. Answer “Yes” if you want to continue with the editing.

Answer “No,” the system will return to Step 3.

6. The voice guide will say “Number, please.” Say the telephone number you want to register.

NOTE

- If the telephone number is already registered in the selected location, the voice guide will say “The current number is <current number>. New number, please.” Say a new telephone number to change the current number.

7. The voice guide will repeat the telephone number.

When the confirmation function is on, the system will ask if the number is correct. Answer “Yes.”

Answer “No,” the system will return to the Step 3.

8. Once the telephone number is registered, the voice guide will say “Number saved” and then the system will return to the main menu.

Bluetooth® 2.0 interface (if so equipped)

NOTE

- If the location where a telephone number was already registered has been overwritten with a new number, the voice guide will say “Number changed” and then the system will return to the main menu.

5

◆ Editing a name

N00580100071

1. Press the SPEECH button.
2. Say “Phonebook.”
3. The voice guide will say “Select one of the following: new entry, edit number, edit name, list names, delete, erase all, or import contact.” Say “Edit name.”
4. The voice guide will say “Please say the name of the entry you would like to edit, or say list names.” Say the name you want to edit.

NOTE

- Say “List names,” and the names registered in the phonebook are read out in order. Refer to “Vehicle phonebook: Listening to the list of registered names” on page 5-148.

5. The voice guide will say “Changing <name>.”

Bluetooth® 2.0 interface (if so equipped)

5

When the confirmation function is on, the system will check if the name is correct. Answer “Yes” if you want to continue with the editing based on this information. Answer “No,” the system will return to Step 4.

6. The voice guide will say “Name please.” Say the new name you want to register.
7. The registered name will be changed. When the change is complete, the system will return to the main menu.

◆ Listening to the list of registered names

N00580200069

1. Press the SPEECH button.
2. Say “Phonebook.”
3. The voice guide will say “Select one of the following: new entry, edit number, edit name, list names, delete, erase all, or import contact.” Say “List names.”
4. Bluetooth® 2.0 interface will read out the entries in the phonebook in order.
5. When the voice guide is done reading the list, it will say “End of list, would you like to start from the beginning?” When you want to check the list again from the beginning, answer “Yes.” When you are done, answer “No” to return to the previous or main menu.

NOTE

- You can call, edit or delete a name that is being read out. Press the SPEECH button and say “Call” to call the name, “Edit name” to edit it, or “Delete” to delete it. The system will beep and then execute your command.
- If you press the SPEECH button and say “Continue” or “Previous” while the list is being read, the system will advance or rewind the list. Say “Continue” to proceed to the next entry or “Previous” to return to the previous entry.

◆ Deleting a telephone number

N00580300073

1. Press the SPEECH button.
2. Say “Phonebook.”
3. The voice guide will say “Select one of the following: new entry, edit number, edit name, list names, delete, erase all, or import contact.” Say “Delete.”
4. The voice guide will say “Please say the name of the entry you would like to delete, or say list names.” Say the name of the phonebook entry in which the telephone number you want to delete is registered.

NOTE

- Say “List names,” and the names registered in the phonebook are read out in order. Refer to “Vehicle phonebook: Listening to the list of registered names” on page 5-148.

5. If only one telephone number is registered in the selected phonebook entry, the voice guide will say “Deleting <name> <location>.”

If multiple telephone numbers are registered in the selected phonebook entry, the voice guide will say “Would you like to delete [home], [work], [mobile], [other], or all?”

Select the location to delete, and the voice guide will say “Deleting <name> <location>.”

NOTE

- To delete the telephone numbers from all locations, say “All.”

6. The system will ask if you really want to delete the selected telephone number(s) to go ahead with the deletion, answer “Yes.” Answer “No,” the system will cancel deleting the telephone number(s) and then return to Step 4.

- When the telephone number deletion is complete, the voice guide will say “<name> <location> deleted” and then the system will return to the main menu. If all locations are deleted, the system will say “<name> and all locations deleted” and the name will be removed from the phonebook. If numbers still remain under the entry, the name will retain the other associated numbers.

■ Erasing the phonebook

N00580400061

You can delete all registered information from the vehicle phonebook.

- Press the SPEECH button.
- Say “Phonebook.”
- The voice guide will say “Select one of the following: new entry, edit number, edit name, list names, delete, erase all, or import contact.” Say “Erase all.”
- For confirmation purposes, the voice guide will ask “Are you sure you want to erase everything from your hands-free system phonebook?” Answer “Yes.” Answer “No” to cancel the deletion of all registered information in the phonebook and return to the main menu.

- The voice guide will say “You are about to delete everything from your hands-free system phonebook. Do you want to continue?” Answer “Yes” to continue. Answer “No” to cancel the deletion of all registered information in the phonebook and return to the main menu.
- The voice guide will say “Please wait, erasing the hands-free system phonebook” and then the system will delete all data in the phonebook. When the deletion is complete, the voice guide will say “Hands-free system phonebook erased” and then the system will return to the main menu.

Mobile phonebook

N00566201088

All entries in the phonebook stored in the cellular phone can be transferred in a batch and registered in the mobile phonebook. Up to 7 mobile phonebooks, each containing up to 1,000 names, can be registered.

The Bluetooth® 2.0 interface automatically converts from text to voice the names registered in the transferred phonebook entries, and creates names.

Bluetooth® 2.0 interface (if so equipped)

NOTE

- Only the mobile phonebook transferred from the connected cellular phone can be used with that cellular phone.
- You cannot change the names and telephone numbers in the phonebook entries registered in the mobile phonebook. You cannot select and delete specific phonebook entries, either. To change or delete any of the above, change the applicable information in the source phonebook of the cellular phone and then transfer the phonebook again.

To import a devices phonebook

Follow the steps below to transfer to the mobile phonebook the phonebook stored in the cellular phone.

NOTE

- Transfer should be completed while the vehicle is parked. Before transferring, make sure that the vehicle is parked in a safe location.
- The already stored phonebook in the mobile phonebook is overwritten by the stored phonebook in the cellular phone.
- All or part of data may not be transferred, even when the cellular phone supports Bluetooth®, depending on the compatibility of the device.
- Only a home, a work, and a mobile number can be imported.

Bluetooth® 2.0 interface (if so equipped)

5

 **NOTE**

- The maximum supported telephone number length is 19 digits. Any telephone number of 20 digits or more will be truncated to the first 19 digits.
- If telephone numbers contain characters other than 0 to 9, *, # or +, these characters are deleted before the transfer.
- For the connection settings on the cellular phone side, refer to the instructions for the cellular phone.

1. Press the SPEECH button.
2. Say "Phonebook."
3. The voice guide will say "Select one of the following: new entry, edit number, edit name, list names, delete, erase all, or import contact." Say "Import contact."
4. The voice guide will say "Would you like to import a single entry or all contacts?" Say "All contacts."
5. The voice guide will say "Importing the contact list from the mobile phonebook. This may take several minutes to complete. Would you like to continue?" Answer "Yes," transferring to the mobile phonebook the phonebook stored in the cellular phone will start. Answer "No," the system will return to the main menu.

 **NOTE**

- The transfer may take some time to complete depending on the number of contacts.
- If the Bluetooth® 2.0 interface could not be connected to the Bluetooth® compatible cellular phone, the voice guide will say "Unable to transfer contact list from phone" and then the system will return to the main menu.
- If you press the HANG-UP button or press and hold the SPEECH button during the data transfer, the transfer will be cancelled and the system will return to the main menu.
- If an error occurs during the data transfer, all transfer will be cancelled and the voice guide will say "Unable to complete the phonebook import" and then the system will return to the main menu.
- If there are no contacts in the phonebook, the voice guide will say "There are no contacts on the connected phone."

6. When the transfer is complete, the voice guide will say "Import complete" and then the system will return to the main menu.

General information

N00566301106

MODEL: MMC FCC ID: CB2MDGMY10
IC: 279B-MDGMY10

Your Bluetooth® 2.0 interface operates on a radio frequency subject to Federal Communications Commission (FCC) Rules (For vehicles sold in U.S.A.) and Industry Canada Rules (For vehicles sold in Canada). This device complies with Part 15 of the FCC Rules and RSS-210 of the Industry Canada Rules. Operation is subject to the following two conditions:

- This device may not cause harmful interference.
- This device must accept any interference received, including interference that may cause undesired operation.

 **CAUTION**

- Changes or modifications made to this equipment not expressly approved by the manufacturer may void the FCC authorization to operate this equipment.

The term "IC:" before the radio certification number only signifies that Industry Canada technical specifications were met.

The antenna used for this transmitter must not be co-located or operating in conjunction with any other antenna or transmitter. End-users and installers must be provided with installation instructions and transmitter operating conditions for satisfying RF exposure compliance.

FCC Notice: This equipment has been tested and found to comply with the limits for a Class B digital device, pursuant to part 15 of the FCC Rules. These limits are designed to provide reasonable protection against harmful interference in a residential installation.

This equipment generates, uses and can radiate radio frequency energy and, if not installed and used in accordance with the instructions, may cause harmful interference to radio communications.

However, there is no guarantee that interference will not occur in a particular installation. If this equipment does cause harmful interference to radio or television reception, which can be determined by turning the equipment off and on, the user is encouraged to try to correct the interference by one or more of the following measures:

- Reorient or relocate the receiving antenna.
- Increase the separation between the equipment and receiver.
- Connect the equipment into an outlet on a circuit different from that to which the receiver is connected.
- Consult the dealer or an experienced radio/TV technician for help.

ICES Notice: This Class B digital apparatus complies with Canadian ICES-003.

Enrollment commands

N00566401093

Phrase	English	Spanish	French	Japanese
1	123456789	123456789	123456789	123456789
2	888 555 1212	888 555 1212	888 555 1212	888 555 1212
3	Call	Llamar	Appeler	呼び出し
4	Dial	Marcar	Composer	ダイヤル
5	Setup	Configurar	Configurer	設定
6	Cancel	Cancelar	Annuler	キャンセル
7	Continue	Continuar	Continuer	つぎ
8	Help	Ayuda	Aide	ヘルプ

USB input terminal

N00566701126

You can connect your USB memory device or iPod* to play music files stored in the USB memory device or iPod. This section explains how to connect and remove a USB memory device or iPod. See the following section for details on how to play music files.

Refer to “Listen to an iPod” on page 7-28.
Refer to “Listen to Audio Files on a USB Device” on page 7-30.

Refer to “To play iPod/USB memory device tracks via voice operation” on page 7-33.

*: “iPod” is a registered trademark of Apple Inc. in the United States and other countries.

USB input terminal

How to connect a USB memory device

N00566801130

1. Park your vehicle in a safe place and turn the ignition switch to the “LOCK” position.
2. Open the USB input terminal cover (A) in the center console box.

5

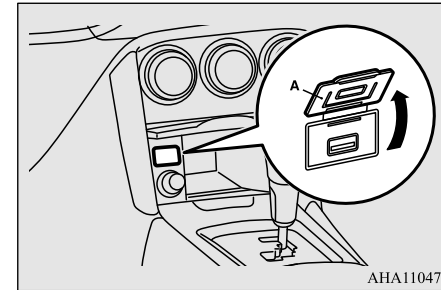

AHA110477

3. Connect a commercially available USB connector cable (C) to the USB memory device (B).

USB input terminal

5

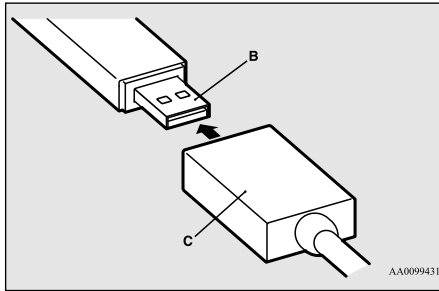

4. Connect the USB connector cable (C) to the USB input terminal (D).

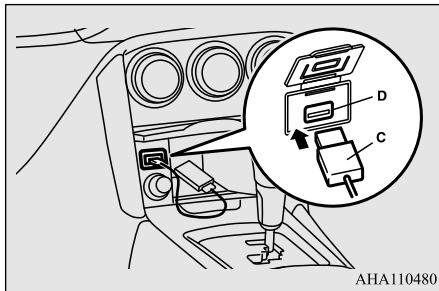

CAUTION

- Keep the lid of the center console box closed while driving the vehicle. A lid or the contents of the center console box could otherwise cause injuries.

NOTE

- Do not connect the USB memory device to the USB input terminal directly. The USB memory device may be damaged.
- When closing the center console box, be careful not to trap the USB connector cable.

5. To remove the USB connector cable, turn the ignition switch to the “LOCK” position first and perform the installation steps in reverse.

How to connect an iPod

N00566901128

1. Park your vehicle in a safe place and turn the ignition switch to the “LOCK” position.
2. Open the USB input terminal cover (A) in the center console box.

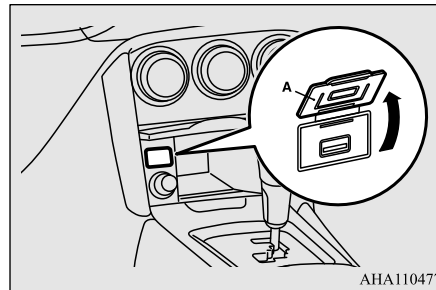

3. Connect the Dock connector (C) to the iPod (B).

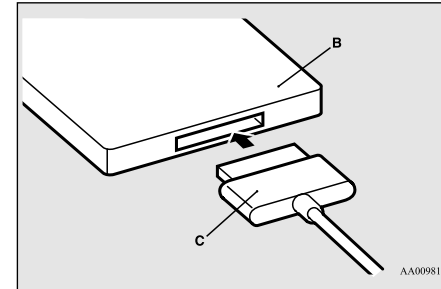

NOTE

- Use a genuine Dock connector from Apple Inc.

4. Connect the Dock connector (C) to the USB input terminal (D).

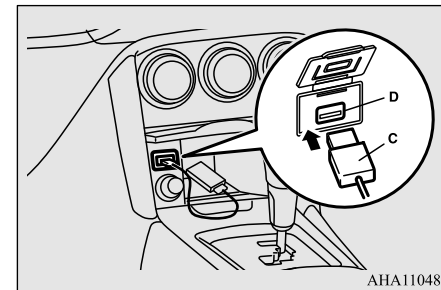

USB input terminal

CAUTION

- Keep the lid of the center console box closed while driving the vehicle. A lid or the contents of the center console box could otherwise cause injuries.

NOTE

- When closing the center console box, be careful not to trap the connector cable.

5. To remove the Dock connector, turn the ignition switch to the “LOCK” position first and perform the installation steps in reverse.

Types of connectable devices and supported file specifications

N00567001054

Except for vehicles equipped with the Bluetooth® 2.0 interface

N00583200044

For details about the types of connectable devices and supported file specifications, refer to the following pages and manuals.

For vehicles equipped with the AM/FM radio/CD player

Refer to “Listen to an iPod” on page 7-28, “Listen to Audio Files on a USB Device” on page 7-30 and “Audio Files (MP3/WMA/AAC)” on page 7-15.

For vehicles equipped with the DISPLAY AUDIO

Refer to the separate owner’s manual.

For vehicles equipped with the Bluetooth® 2.0 interface

N00583300029

For details about the types of connectable devices and supported file specifications, refer to the following section.

■ **Device types**

N00583400033

Devices of the following types can be connected.

Model name	Condition
USB memory device	Storage capacity of 256 Mbytes or more

Model name	Condition
Models other than USB memory devices and iPods	Digital audio player supporting mass storage class

For these connectable device types, “iPod*,” “iPod classic*,” “iPod nano*,” “iPod touch*” and “iPhone*,” refer to the following website:

[For vehicles sold in U.S.A.]

You can access the Mitsubishi Motors North America website.

[For vehicles sold in Canada]

You can access the Mitsubishi Motors website. Please read and agree to the “Warning about Links to the Web Sites of Other Companies”. The websites mentioned above may connect you to websites other than the Mitsubishi Motors website.

<http://www.mitsubishi-motors.com/en/products/index.html>

*: “iPod,” “iPod classic,” “iPod nano,” “iPod touch,” and “iPhone” are registered trademarks of Apple Inc. in the United States and other countries.

5

5

Sun visors

NOTE

- Depending on the type of the USB memory device or other device connected, the connected device may not function properly or the available functions may be limited.
- It is recommended to use an iPod with firmware updated to the latest version.
- You can charge your iPod by connecting it to the USB input terminal when the ignition switch is in the “ACC” or “ON” position.
- Do not keep your USB memory device or iPod in your vehicle.
- It is recommended that you back up the files in case of data damage.
- Do not connect to the USB input terminal any device (hard disk, card reader, memory reader, etc.) other than the connectable devices specified in the previous section. The device and/or data may be damaged. If any of these devices was connected by mistake, remove it after turning the ignition switch to the “LOCK” position.

File specifications

N00583500021

You can play music files of the following specifications that are saved in a USB memory device or other device supporting mass storage class. When you connect your iPod, playable file specifications depend on the connected iPod.

Item	Condition
File format	MP3, WMA, AAC, WAV
Maximum number of levels (including the root)	Level 8
Number of folders	700
Number of files	65,535

Sun visors

N00524600294

Fold the sun visor downward (1) to reduce front glare while driving. To reduce side glare, turn the visor to the side (2).

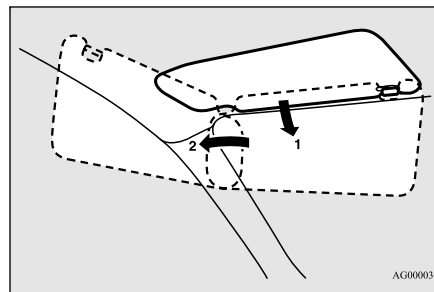

AG0000309

Vanity mirror

The vanity mirrors are located on the back of the sun visors.

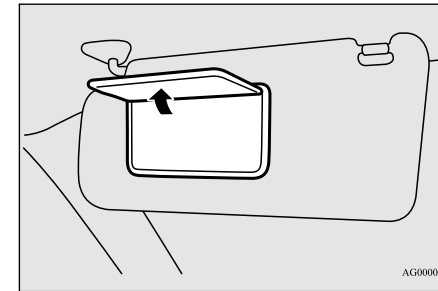

AG0000325

Card holder

Cards can be slipped into the front (A) of the lid of the vanity mirror.

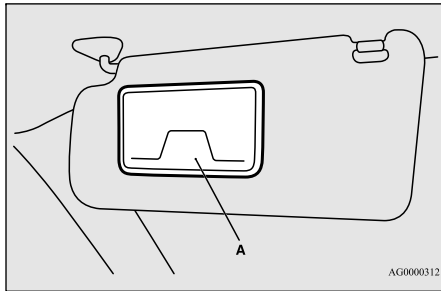

12 V power outlet

N00525001654

CAUTION

- Be aware that using electronic equipment with the engine off may run the battery down.
- When the 12 V power outlet is not in use, be sure to put on the plug or close the 12 V power outlet cover. This will prevent the 12 V power outlet from becoming dirty and possibly short-circuiting.

12 V power outlets are located in inside of the center console box (Type 1) and inside of the floor console box (Type 2).

NOTE

- Two 12 V power outlets can be used simultaneously.

CAUTION

- Be sure to use a “plug-in” type accessory operating at 12 V and 120 W or less. When using two 12 V power outlets simultaneously, make sure that the total power consumption of these does not exceed 120 W at 12 V.

Type 1

The accessory can be operated when the ignition switch is in the “ON” or “ACC” position. To use a “plug-in” type accessory, pull out the plug, then insert the plug in the socket.

12 V power outlet

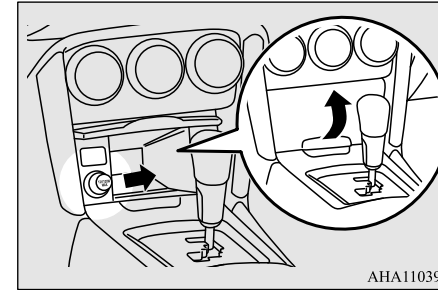

5

Type 2

The accessory can be operated when the ignition switch is in any position. To use a “plug-in” type accessory, open the cover, then insert the plug in the socket.

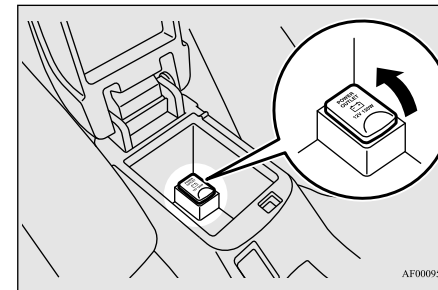

Interior lights

Interior lights

N00525301628

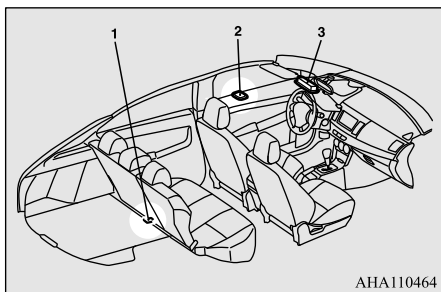

- 1- Cargo room light →P.5-158
- 2- Dome light (Rear)(if so equipped)
→P.5-157
- 3- Dome light (Front)/Reading lights
→P.5-156

Dome light (Front)/Reading lights

N00525801287

Dome light (Front)

The dome light can be turned on by sliding the dome light switch.

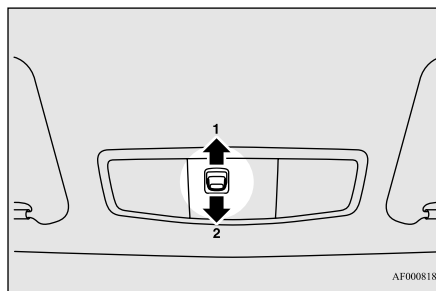

1- (DOOR)

The dome light comes on when any door or the rear hatch is opened. When all the doors and the rear hatch are closed, the dome light goes off after approximately 30 seconds. However, the light goes off immediately if:

- The doors and the rear hatch are closed while the ignition switch is in the “ON” position.
- The driver’s door is closed after all the other doors and the rear hatch are closed while the lock knob of the driver’s door is in the lock position.
- The doors and the rear hatch are closed and the power door lock switch is used to lock the doors.
- The keyless entry system remote control transmitter is used to lock the doors and the rear hatch.
- In vehicles equipped with the F.A.S.T.-key, the doors and the rear hatch are locked using the F.A.S.T.-key.

NOTE

- When the engine is started using the key while the doors and rear hatch are closed, if you remove the key, the dome light will illuminate for approximately 30 seconds before going off.
- When the engine is started using the F.A.S.T.-key while the doors and rear hatch are closed, if the ignition switch is moved to the “LOCK” position, the dome light will illuminate for approximately 30 seconds before going off.
- The time until the light goes off can be adjusted. See your authorized Mitsubishi Motors dealer for details.

Interior lights

2- (OFF)

The dome light goes off.

Reading lights

N00553800070

Regardless of the dome light switch position, when you press the lens, the light on the side that is pressed illuminates; when you press the lens again, the light goes off.

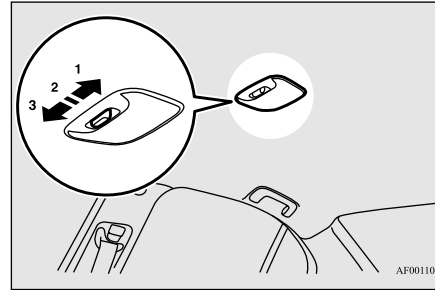

1- (ON)

The dome light comes on.

2- (●)

The dome light comes on when any door or the rear hatch is opened. When all the doors and the rear hatch are closed, the dome light goes off after approximately 30 seconds. However, the light goes off immediately if:

- The doors and the rear hatch are closed while the ignition switch is in the "ON" position.
- The driver's door is closed after all the other doors and the rear hatch are closed while the lock knob of the driver's door is in the lock position.

- The door and the rear hatch are closed and the power door lock switch is used to lock the doors.
- The keyless entry system remote control transmitter is used to lock the doors and the rear hatch.
- In vehicles equipped with the F.A.S.T.-key, the doors and the rear hatch are locked using the F.A.S.T.-key.

5

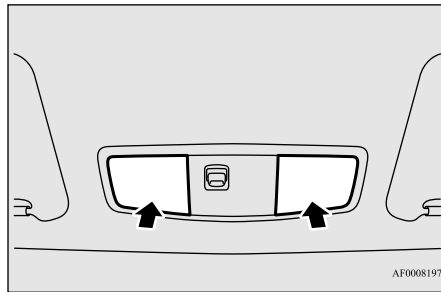

Dome light (Rear) (if so equipped)

N00525401502

The dome light can be turned on by sliding the dome light switch.

NOTE

- When the engine is started using the key while the doors and the rear hatch are closed, if you remove the key, the dome light will illuminate for approximately 30 seconds before going off.
- When the engine is started using the F.A.S.T.-key while the doors and the rear hatch are closed, if the ignition switch is moved to the "LOCK" position, the dome light will illuminate for approximately 30 seconds before going off.
- The time until the light goes off can be adjusted. See your authorized Mitsubishi Motors dealer for details.

3- (OFF)

The dome light goes off.

Storage spaces

Cargo room light

N00526200063

5

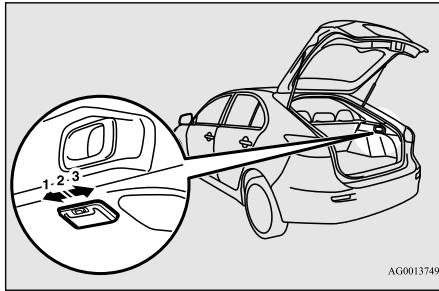

AG0013749

1- (ON)

The light illuminates regardless of whether the rear hatch is open or closed.

2-

The light illuminates when the rear hatch is open, and goes off when the rear hatch is closed.

3- (OFF)

The light remains off regardless of whether the rear hatch is open or closed.

Interior light auto-cutout function (dome light and other lights)

N00526301478

If any of the interior lights are left on with the ignition switch in the "LOCK" position, the lights go off automatically after about 30 minutes.

The lights come on again if the ignition switch is turned to the "ON" or "ACC" position, any door or the rear hatch is opened and closed, or the keyless entry system or F.A.S.T.-key is operated.

NOTE

- The interior light auto-cutout function can be deactivated. The time until the lights automatically go off can be adjusted. See your authorized Mitsubishi Motors dealer for details.

Storage spaces

N00526401583

CAUTION

- Never leave lighters, carbonated drink cans, or spectacles in the cabin when parking the vehicle in hot sunshine. The cabin will become extremely hot, so lighters and other flammable items may catch fire and unopened drink cans (including beer cans) may rupture. The heat may also deform or crack plastic spectacle parts.
- Keep the lids of storage spaces closed while driving the vehicle. A lid or the contents of a storage space could otherwise cause injuries during a sudden stop.

NOTE

- Do not leave valuables in any storage space when leaving the vehicle.

Storage spaces

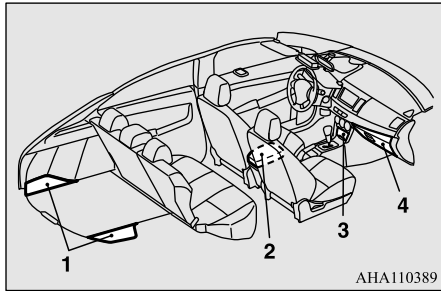

- 1- Cargo floor boxes →P.5-160
- 2- Floor console box →P.5-159
- 3- Center console box →P.5-159
- 4- Glove compartment →P.5-159

Glove compartment

N00551501315

To open the glove compartment, pull the lever (A).

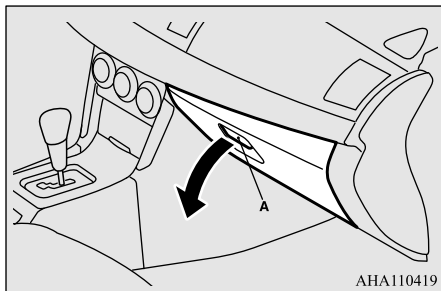

WARNING

- An open glove compartment door can cause a serious injury or death to the front passenger in an accident, even if the passenger is wearing his/her seat belt. Always keep the glove compartment door closed when driving.

Card holder

There is a card holder on the inside of the glove compartment.

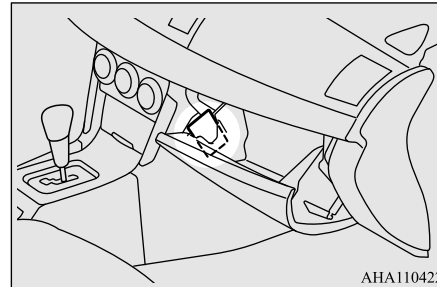

NOTE

- Up to 2 cards will fit in the card holder.

Center console box

N00547801030

To open, pull the lid.

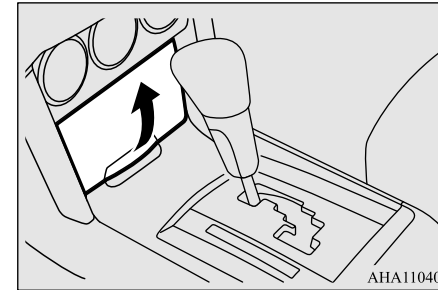

5

NOTE

- The USB input terminal is located in the center console box. For details, refer to “USB input terminal” on page 5-151
- Do not use the center console box as an ashtray. This could cause a fire or damage the center console box.

Floor console box

N00551600175

To open the floor console box, lift the right release lever (A) and raise the lid.

Features and controls 5-159

Cup holder

5

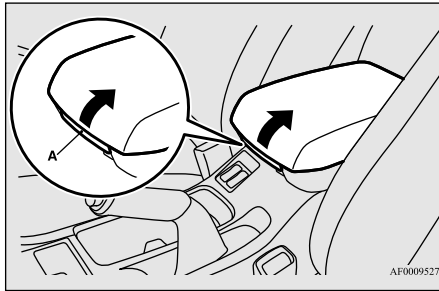

Tissue holder

The tissue holder (A) is located on the underside of the floor console box lid.

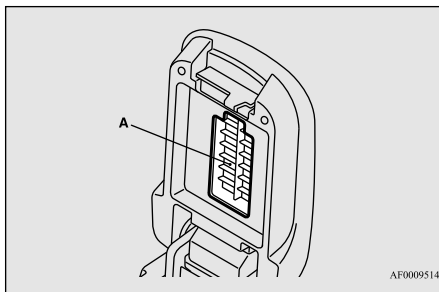

Cargo floor boxes

N00552301059

The boxes for storing articles are located inside the luggage compartment. To use the boxes, raise the lids (A).

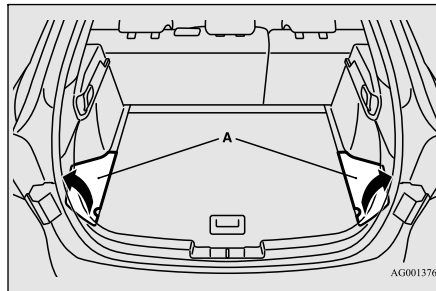

Cup holder

N00527301459

For the front seat

The cup holder is located the middle of the floor console. The cup holder is designed for holding cups or drink-cans securely.

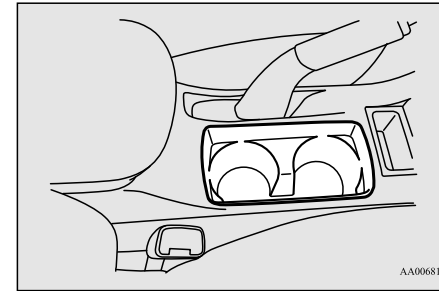

CAUTION

- Do not drink beverages while driving your vehicle. This is distracting and could cause an accident.

For the rear seat

N00537000162

This cup holder is located in the rear seat arm rest (A). Pull the rear arm rest down to use the cup holder.

Bottle holder

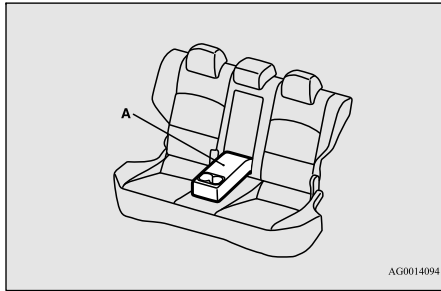

There are bottle holders located on both sides of the front seats.

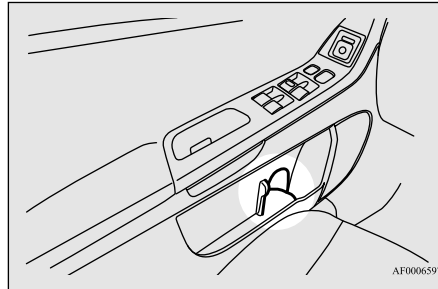

To install

1. Insert the concave portion (A) on the underside of the rear shelf panel into the inside protruding portion (B) on both sides of the luggage compartment.

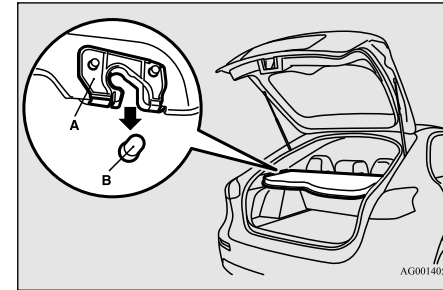

5

Bottle holder

N00502800049

- CAUTION**
- Do not drink beverages while driving your vehicle. This is distracting and could cause an accident.
 - Vibration and shaking while driving may cause beverages to spill. Be very careful, as spilling hot beverages could cause burns.

- NOTE**
- Make sure all lids are tightly closed when storing beverages that are in plastic bottles, etc.
 - Some beverages may not be stored, depending on the size and shape of the plastic bottles, etc.

Rear shelf panel

N00528200070

- WARNING**
- To avoid obstructing your rearward view, never place anything on the rear shelf panel. In the event of sudden braking or an accident, objects placed on the rear shelf panel could strike occupants causing injury.

- WARNING**
- Lightly push the rear shelf panel to make sure that the concave portion (A) is set firmly in the protruding portion (B) on both sides of the luggage compartment. Unsecured rear shelf panel can strike occupants causing injury in the event of sudden braking or an accident.

2. Hang the strap (C) of the rear shelf panel on the hook (D).

Dual height adjustable cargo floor board

5

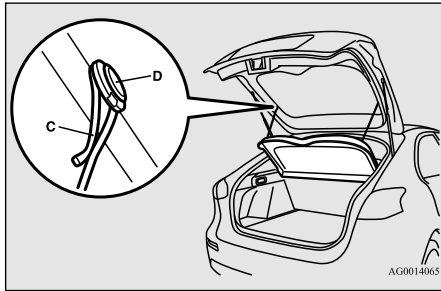

CAUTION

- Handle the board with care so as to not injure your fingers and your hands.

NOTE

- Before handling the board, remove any luggage from the luggage compartment.
- When loading heavy luggage, the board must be set in the lower position to avoid damage to the board.

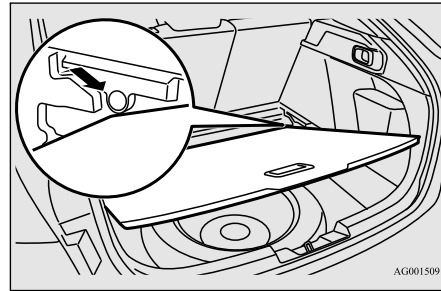

To remove

Follow this procedure in reverse to remove.

Dual height adjustable cargo floor board

N00562401037

To increase the capacity of the luggage compartment, the board can be lowered.

CAUTION

- The exhaust pipe remains hot for a while after stopping the engine, so be sure not to touch it.
- Do not stand behind the exhaust pipe when loading and unloading luggage. The heat from the exhaust could cause burns.

1. Raise the rear part of the board.

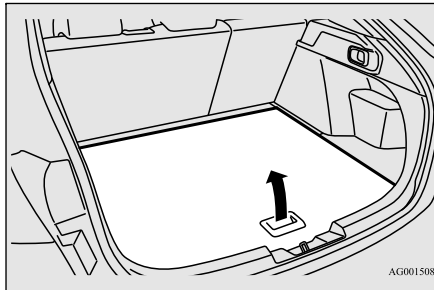

2. Pull the board toward you until the front part is lowered.

3. Push the board in all the way with the front part lowered, then set the board into place.

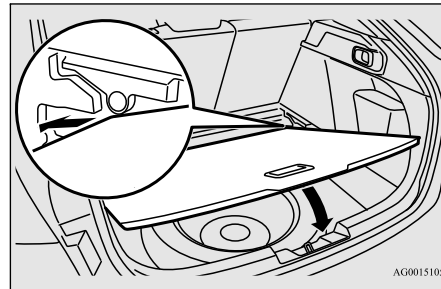

4. Make sure the board is set firmly in place.
5. Follow this procedure in reverse to return the board to its original position.

Assist grip

N0055900029

These grips are to support the body by hand while seated in the vehicle.

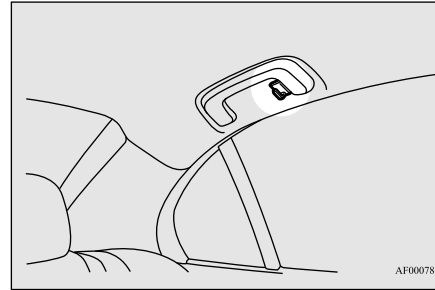
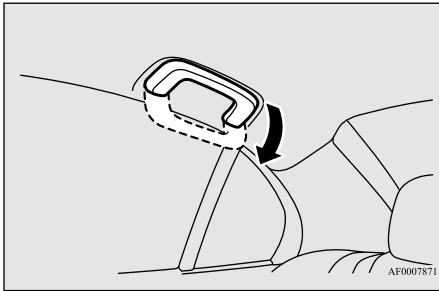

AF0007884

⚠ CAUTION

- Do not use the assist grips when getting into or out of the vehicle. The assist grips could detach and cause an accident.

⚠ WARNING

- Do not put a hanger or any heavy or pointed object on the coat hook. If the curtain airbag was activated, any such item could be propelled away with great force and could prevent the curtain airbag from inflating correctly. Hang clothes directly on the coat hook (without using a hanger). Make sure there are no heavy or sharp objects in the pockets of clothes that you hang on the coat hook.

Coat hook

N00553600124

There is a coat hook on the rear seat assist grip of the driver's side.

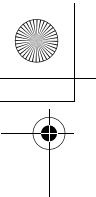

Handwriting practice area consisting of ten horizontal dashed lines.

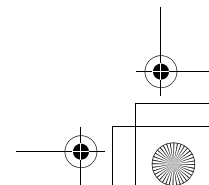
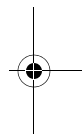
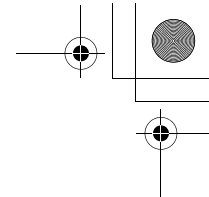
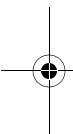

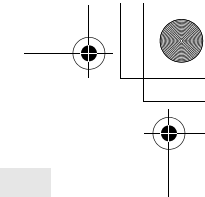

Driving safety

Fuel economy	6-2
Driving, alcohol and drugs	6-2
Floor mat	6-2
Vehicle preparation before driving	6-3
Safe driving techniques	6-4
Driving during cold weather	6-4
Braking	6-5
Parking	6-5
Loading information	6-6
Cargo loads	6-10
Trailer towing	6-11

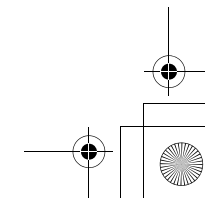
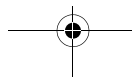
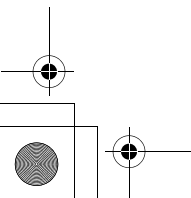
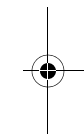
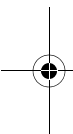

Fuel economy

Fuel economy

N00628800107

Fuel economy is dependent on many factors. Your personal driving habits can have a significant effect on your fuel use. Several recommendations for achieving the greatest fuel economy are listed below.

6

- Whenever accelerating from a stop, always accelerate slowly and smoothly.
- When parked for even a short period, do not idle the engine. Shut it off.
- Plan your trips to avoid unnecessary stops.
- Keep your tires inflated to the recommended pressures.
- For freeway driving, maintain a speed of approximately 50 mph (80 km/h) when traffic, roadway and weather conditions safely permit.
- Keep your air filter clean and your vehicle lubricated according to the recommendations in this manual.
- Always keep your vehicle well maintained. A poorly maintained engine wastes fuel and costs money.
- Do not overload your vehicle.

Driving, alcohol and drugs

N00628900052

Drunk driving is one of the most frequent causes of accidents.

Your driving ability can be seriously impaired even with blood alcohol levels far below the legal minimum. If you have been drinking, don't drive. Ride with a designated non-drinking driver, call a cab or a friend, or use public transportation. Drinking coffee or taking a cold shower will not make you sober. Similarly, prescription and nonprescription drugs affect your alertness, perception and reaction time. Consult with your doctor or pharmacist before driving while under the influence of any of these medications.

WARNING

- **NEVER DRINK AND DRIVE.**
Your perceptions are less accurate, your reflexes are slower and your judgment is impaired.

Floor mat

N00628600017

The original equipment floor mat provided with your vehicle was specifically designed for your vehicle. Always properly position the floor mat and assure it does not interfere with operation of the pedals. Always use the

retaining clip on the driver's floorboard to secure the floor mat. When used, this clip will help prevent the floor mat from moving forward and possibly interfering with the operation of the pedals. To prevent the floor mat from moving forward and possibly interfering with the operation of the pedals, Mitsubishi genuine floor mats are recommended.

To install the floor mat

N00628700050

1. Place the floor mat to fit the shape of the floorboard.
2. Align the floor mat with the installation holes over the retaining clips.
3. Secure the floor mat with retaining clips.

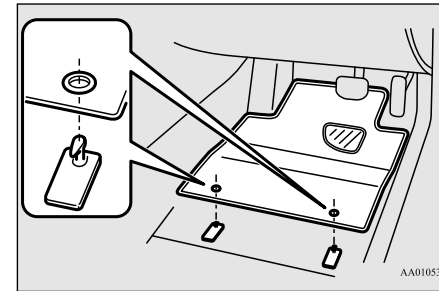

AA0105323

NOTE

- The shape of the mat and the number of retaining clips may vary depending on the vehicle model.

⚠ WARNING

- If a floor mat is the wrong size or is not properly installed, it can interfere with the operation of the pedals. Interference with the pedals can cause unintended acceleration and/or increased stopping distances resulting in a crash and injury. Always make sure the floor mat does not interfere with the accelerator or brake pedal.
- Always use the retaining clip on the driver's floorboard to secure the floor mat.
- Always install the mat with the correct side facing down.
- Never install a second mat over or under an existing floor mat.
- Do not use a floor mat designed for another model vehicle even if it is a Mitsubishi genuine floor mat.
- Before driving, be sure to check the following:
 - Periodically check that the floor mat is properly secured with the retaining clips. If you remove the floor mat while cleaning the inside of your vehicle or for any other reason, always check the condition of the floor mat after it has been reinstalled.
 - While the vehicle is stopped with the engine off, check that the floor mat is not interfering with the pedals by depressing the pedals fully.

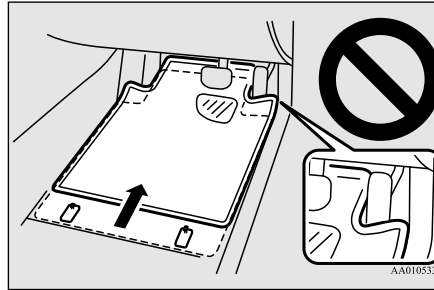

Vehicle preparation before driving

N00629001754

For a safer and more enjoyable trip, always observe the following:

Seat belts and seats

- Before starting the vehicle, make certain that you and all passengers are seated and wearing their seat belts properly (with children in the rear seat, in appropriate restraints), and that all the doors and the rear hatch are locked.

Vehicle preparation before driving

- Move the driver's seat as far backward as possible, while still keeping good visibility, and good control of the steering wheel, brakes, accelerator, and controls. Check the instrument panel indicators and multi-information display for any possible problem.
- Move the front passenger seat as far back as possible.
- Make sure that infants and small children are properly restrained in accordance with all laws and regulations.

6

Defrosters

Check these by selecting the defroster mode, and set the blower switch on high. You should be able to feel the air blowing against the windshield.

(Refer to "Defrosting or defogging (windshield, door windows)" on page 7-8.)

Tires

Check all the tires for heavy tread wear or uneven wear patterns. Look for stones, nails, glass, or other objects stuck in the tread. Look for any tread cuts or sidewall cracks. Check the wheel nuts for tightness, and the tires (including spare tire) for proper pressures.

Safe driving techniques

Replace your tires before they are heavily worn out.

As your vehicle is equipped with a tire pressure monitoring system, there is a risk of damage to the tire inflation pressure sensors when the tire is replaced on the rim. Tire replacement should, therefore, be performed only by an authorized Mitsubishi Motors dealer.

6

Lights

Have someone watch while you turn all the exterior lights on and off. Also check the turn signal indicators and high-beam indicators on the instrument panel.

Fluid leaks

Check the ground under the vehicle after parking overnight, for fuel, water, oil, or other leaks. Make sure all the fluid levels are correct. Also, if you can smell fuel, you need to find out why immediately and have it fixed.

Safe driving techniques

N00629200078

Even this vehicle's safety equipment, and your safest driving, cannot guarantee that you

6-4 Driving safety

can avoid an accident or injury. However, if you give extra attention to the following areas, you can better protect yourself and your passengers:

- Drive defensively. Be aware of traffic, road and weather conditions. Leave plenty of stopping distance between your vehicle and the vehicle ahead.
- Before changing lanes, check your mirrors and use your turn signal light.
- While driving, watch the behavior of other drivers, bicyclists, and pedestrians.
- Always obey applicable laws and regulations. Be a polite and alert driver. Always leave room for unexpected events, such as sudden braking.
- If you plan to drive in another country, obey their vehicle registration laws and make sure you will be able to get the right fuel.

Driving during cold weather

N00629401484

- Check the battery, including terminals and cables. During extremely cold weather, the battery will not be as strong. Also, the battery power level may drop because more power is used for cold starting and driving.

Before driving the vehicle, check to see if the engine runs at the proper speed and if the headlights are as bright as normally. Charge or replace the battery if necessary. During extreme cold weather, it is possible that a very low battery could freeze.

WARNING

- **The battery gives off explosive hydrogen gas. Any spark or flame can cause the battery to explode, which could cause serious injury or death.**
Always wear protective clothes and a face mask when working with your battery, or let a skilled mechanic do it.

- Warm the engine sufficiently. After starting the engine, allow a short warm-up time to distribute oil to all cylinders. Then drive your vehicle slowly.
- Stay at low speeds at first so that the transaxle, transfer case and rear axle oil have time to spread to all the lubrication points.
- Manual transaxle can be harder to shift in cold weather conditions. This is normal and shifting will get easier as the transaxle warms up.
- Check the engine antifreeze.
If there is not enough coolant because of a leak or from engine overheating, add Mitsubishi Motors Genuine Super Long Life Coolant Premium or equivalent.

Please read this section in conjunction with the “Engine coolant” on page 9-7.

WARNING

- **Never open the radiator cap when the radiator is hot. You could be seriously burned.**

Braking

N00629500488

All the parts of the brake system are critical to safety. Have the vehicle serviced by an authorized Mitsubishi Motors dealer or a repair facility of your choice at regular intervals according to the “WARRANTY AND MAINTENANCE MANUAL”.

When brakes are wet

Check the brake system while driving at a low speed immediately after starting, especially when the brakes are wet, to confirm they work normally.

A film of water can be formed on the brake discs and prevent normal braking after driving in heavy rain or through large puddles, or after the vehicle is washed. If this occurs, dry the brakes out by driving slowly while lightly depressing the brake pedal.

When driving in cold weather

On snowy roads, ice can form on the braking system, making the brakes less effective. While driving in such conditions, pay close attention to preceding and following vehicles and to the condition of the road surface. From time to time, lightly depress the brake pedal and check how effective the brakes are.

When driving downhill

It is important to take advantage of the engine braking by shifting to a lower shift position while driving on steep downhill roads in order to prevent the brakes from overheating.

Parking

N00629601343

Parking on a hill

When parking on a hill, set the parking brake, and turn the front wheels toward the curb on a downhill, or away from the curb on an uphill. If necessary, apply chocks to wheels.

For vehicles equipped with manual transaxle

Place the gearshift lever into the “R” (Reverse) position when parking on a downhill slope, into the 1st position when parking on an uphill slope.

For vehicles equipped with continuously variable transmission (CVT)

Be sure that the parking brake is firmly set when parked and that the selector lever is in the “P” (PARK) position.

When parking on a hill, it is important to set the parking brake before moving the selector lever to the “P” (PARK) position. This prevents loading the parking brake against the transaxle. When this happens, it is difficult to move the selector lever out of the “P” (PARK) position.

Parking with the engine running

Never leave the engine running while you take a short sleep/rest. Also, never leave the engine running in a closed or poorly ventilated place.

Loading information

WARNING

- Leaving the engine running risks injury or death from accidentally moving the gear-shift lever (manual transaxle) or the selector lever (CVT) or from the accumulation of toxic exhaust fumes in the passenger compartment.

6 Where you park

Your front bumper can be damaged if you scrape it over curbs or parking stop blocks. Be careful when traveling up or down steep slopes where your bumper can scrape the road.

WARNING

- Do not park your vehicle in areas where combustible materials such as dry grass or leaves can come in contact with a hot exhaust, since a fire could occur.

When leaving the vehicle

When leaving the vehicle unattended, always carry the key and lock all doors and the rear hatch.

Always try to park your vehicle in a well lit area.

6-6 Driving safety

Loading information

N00629900323

It is very important to know how much weight your vehicle can carry. This weight is called the vehicle capacity weight and includes the weight of all occupants, cargo and non-factory-installed options. The tire and loading information placard located on the driver's door sill of your vehicle will show how much weight it may properly carry.

WARNING

- Never overload your vehicle. Overloading can damage your vehicle, adversely affect vehicle performance, including handling and braking, cause tire failure, and result in an accident.

It is important to familiarize yourself with the following terms before loading your vehicle:

- Vehicle maximum load on the tire: load on an individual tire that is determined by distributing to each axle its share of the maximum loaded vehicle weight and dividing by two.
- Vehicle normal load on the tire: load on an individual tire that is determined by distributing to each axle its share of the curb weight, accessory weight, and normal occupant weight and dividing by two.

- Maximum loaded vehicle weight: the sum of -
 - (a) Curb weight;
 - (b) Accessory weight;
 - (c) Vehicle capacity weight; and
 - (d) Production options weight.
- Curb weight: the weight of a motor vehicle with standard equipment including the maximum capacity of fuel, oil, and coolant.
- Accessory weight: the combined weight (in excess of those standard items which may be replaced) of automatic transmission, power steering, power brakes, power windows, power seats, radio, and heater, to the extent that these items are available as factory-installed equipment (whether installed or not).
- Vehicle capacity weight: the rated cargo and luggage load plus 150 lbs (68 kg)* times the vehicle's designated seating capacity.
- Production options weight: the combined weight of those installed regular production options weighing over 5 lbs (2.3 kg) in excess of those standard items which they replace, not previously considered in curb weight or accessory weight, including heavy duty brakes, ride levelers, roof rack, heavy duty battery, and special trim.

Loading information

- Normal occupant weight: 150 lbs (68 kg)* times the number of specified occupants. (In your vehicle the number is 3)
 - Occupant distribution: distribution of occupants in a vehicle as specified. (In your vehicle the distribution is 2 in front, 1 in second row seat)
- *: 150 lbs (68 kg) is the weight of one person as defined by U.S.A. and Canadian regulations.

well as “the combined weight of occupants and cargo” (A), which is called the vehicle capacity weight. The weight of roof load is included in the definition of “cargo” when determining the vehicle capacity weight. This placard also tells you the size and recommended inflation pressure for the original equipment tires on your vehicle. For more information, refer to “Tires” on page 9-13.

Type 1

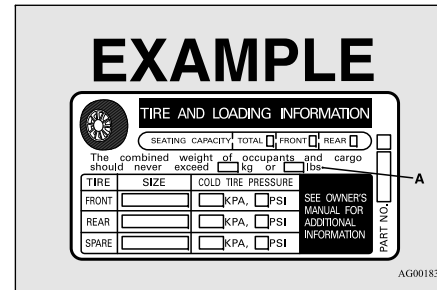

Type 2

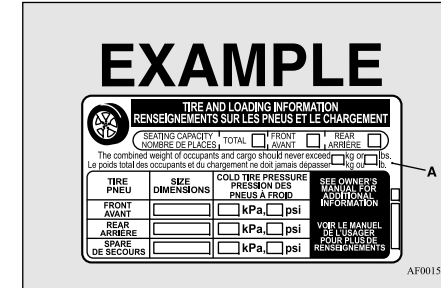

6

Tire and loading information placard

N00630100341

The tire and loading information placard is located on the driver's door sill.

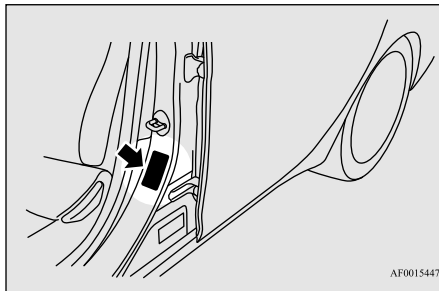

AF0015447

This placard shows the maximum number of occupants permitted to ride in your vehicle as

Steps for Determining Correct Load Limit

N00630201235

1. Locate the statement “The combined weight of occupants and cargo should never exceed XXX kg or XXX lbs.” on your vehicle's placard.
2. Determine the combined weight of the driver and passengers that will be riding in your vehicle.
3. Subtract the combined weight of the driver and passengers from XXX kg or XXX lbs.

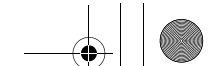

Loading information

6

4. The resulting figure equals the available amount of cargo and luggage load capacity. For example, if the “XXX” amount equals 1400 lbs. and there will be five 150 lbs. passengers in your vehicle, the amount of available cargo and luggage load capacity is 650 lbs. (1400 - 750 (5 x 150) = 650 lbs.)

5. Determine the combined weight of luggage and cargo being loaded on the vehicle. That weight may not safely exceed the available cargo and luggage load capacity calculated in Step 4.

6. If your vehicle will be towing a trailer, load from your trailer will be transferred to your vehicle. Consult this manual to determine how this reduces the available cargo and luggage load capacity of your vehicle.

NOTE

- The above steps for determining correct load limit were written in accordance with U.S.A. regulations. Your vehicle cannot tow a trailer, so step 6 is irrelevant.

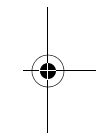
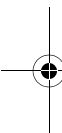

6-8 Driving safety

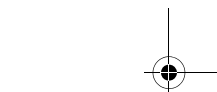
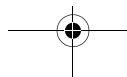

NOTE

- The following table shows examples on how to calculate total cargo/load capacity of your vehicle with varying seating configurations and number and size of occupants. This table is for illustration purposes only and may not be accurate for the seating and load capacity of your vehicle.
- For the following example the combined weight of occupants and cargo should never exceed 865 lbs (392 kg).

Occupants			Combined weight of occupants and cargo from Tire Placard	MINUS	Combined Occupant's weight	=	AVAILABLE Cargo/Luggage Weight
TOTAL	FRONT	REAR					
EXAMPLE 1							
5	2	3	865 lbs (392 kg)	minus	Occupant 1: 200 lbs (91 kg) Occupant 2: 130 lbs (59 kg) Occupant 3: 160 lbs (73 kg) Occupant 4: 100 lbs (45 kg) Occupant 5: 80 lbs (36 kg) TOTAL WEIGHT: 670 lbs (304 kg)	=	195 lbs (88 kg)
EXAMPLE 2							
3	2	1	865 lbs (392 kg)	minus	Occupant 1: 210 lbs (95 kg) Occupant 2: 180 lbs (82 kg) Occupant 3: 150 lbs (68 kg) TOTAL WEIGHT: 540 lbs (245 kg)	=	325 lbs (147 kg)
EXAMPLE 3							
2	2	0	865 lbs (392 kg)	minus	Occupant 1: 200 lbs (91 kg) Occupant 2: 200 lbs (91 kg) TOTAL WEIGHT: 400 lbs (182 kg)	=	465 lbs (210 kg)

AHM100188

- Under a maximum loaded vehicle condition, gross axle weight ratings (GAWR's) for the front and rear axles must not be exceeded. For further information on GAWR's, vehicle loading, see the "Specifications" section of this manual.

Cargo loads

Cargo loads

N00629700493

Cargo load precautions

To determine the cargo load capacity for your vehicle, subtract the weight of all vehicle occupants from the vehicle capacity weight.

6

For added information, if needed, refer to “Steps for Determining Correct Load Limit” on page 6-7.

DO NOT USE the Gross Vehicle Weight Rating and Gross Axle Weight Rating numbers listed on the safety certification label (A) located on the inside sill of the driver’s door as the guide for passengers and/or cargo weight.

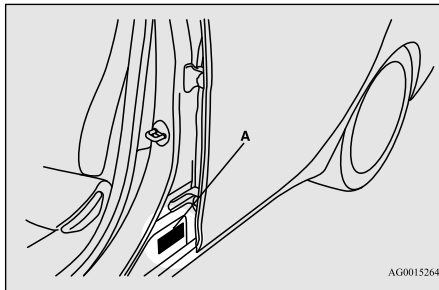

AG0015264

⚠ WARNING

- To reduce the risk of serious injury or death, the combined weights of the driver, passengers and cargo and must never exceed the vehicle capacity weight.
- Exceeding the vehicle capacity weight will adversely affect vehicle performance, including handling and braking, and may cause an accident.
- Do not load cargo or luggage higher than the top of the seatback. Be sure that your cargo or luggage cannot move when your vehicle is in motion.
Having either the rear view blocked, or your cargo being thrown inside the cabin if you suddenly have to brake can cause a serious accident or injury or death.
- Put cargo or luggage in the cargo area of your vehicle. Try to spread the weight evenly.

Loading cargo on the roof

N00630400083

⚠ WARNING

- Weight placed on the roof of the vehicle will raise the vehicle’s center of gravity and adversely affect its handling characteristics. As a result, driving errors or emergency maneuvers could lead to a loss of control and result in an accident. Drive slowly and avoid excessive maneuvers such as sudden braking or quick turning.

⚠ WARNING

- Make sure that the weight of luggage and the roof carrier do not exceed the maximum roof load, 110 lb (50 kg). If the maximum roof load is exceeded, this could cause damage to the vehicle or result in an accident.
- The total weight of all occupants and luggage, including your roof load, must not exceed the vehicle capacity weight. For more information, refer to “Tire and loading information placard” on page 11-3.
- Roof load is determined by adding the weight of the roof carrier and the weight of the luggage placed on the roof carrier.
- For additional information, refer to “Maximum roof load” on page 11-4.

⚠ CAUTION

- Do not load luggage directly onto the roof. Use a roof carrier that properly fits your vehicle.
For installation, refer to the instruction manual provided with the roof carrier.
- Place the luggage on the carrier so that its weight is distributed evenly with the heaviest items on the bottom. Do not load items that are wider than the roof carrier.

Trailer towing

CAUTION

- Before driving and after traveling a short distance, always check the load to make sure it is securely fastened to the roof carrier. Stop the vehicle periodically and check that the load remains secure. If the load is not secure, it could fall from the vehicle and damage your vehicle, another vehicle or create a road hazard.

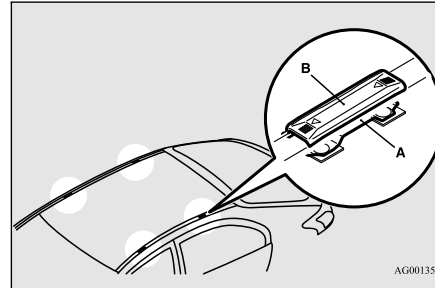

NOTE

- To prevent wind noise or reduction in gas mileage, remove the roof carrier when not in use.
- Before using an automatic car wash, check with the attendant to determine if the roof carrier should be removed.
- Be sure that adequate clearance is maintained for raising the sunroof and/or rear hatch when installing a roof carrier. (For vehicle with sunroof only)

Attaching the roof carrier

Slide each cover (B) toward the front of the vehicle to remove it.

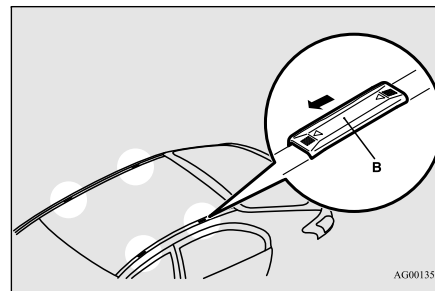

Roof carrier mounting brackets

N0063060072

When installing the roof carrier, use the brackets (A). The brackets (A) are located under each cover (B).

Refitting the covers

1. With each cover, put the tabs (C) on the cover in the holes (D) in the roof.
2. Slide the cover (B) toward the rear of the vehicle to install it.

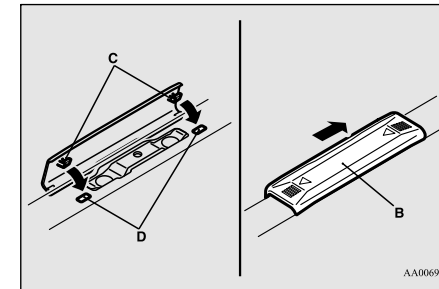

6

Trailer towing

N00629801332

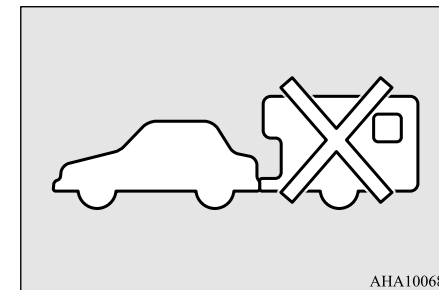

Driving safety 6-11

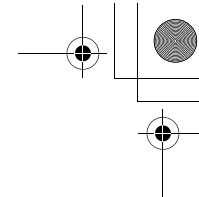

Trailer towing

⚠ WARNING

- Do not use this vehicle for trailer towing. It may not be possible to maintain control or adequate braking.

6

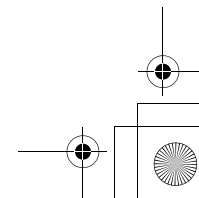
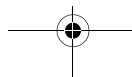
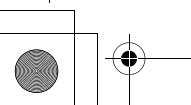
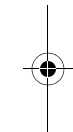
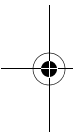

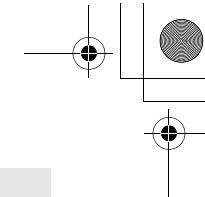

Comfort controls

Vents	7-2
Automatic air conditioning	7-4
Important air conditioning operating tips	7-9
Air purifier	7-9
AM/FM radio/CD player (if so equipped).....	7-10
Handling of Discs	7-13
Audio Files (MP3/WMA/AAC)	7-15
Important Points on Safety for the Customer	7-19
Operation Keys	7-19
Listen to Radio	7-23
Listen to Satellite Radio (if so equipped).....	7-24
Listen to CDs	7-26
Listen to MP3s	7-27
Listen to an iPod	7-28
Listen to Audio Files on a USB Device	7-30
To play iPod/USB memory device tracks via voice operation (vehicles with Bluetooth® 2.0 interface)	7-33
Listen to Bluetooth Audio (if so equipped).....	7-36
Display Indicator	7-38
Audio Quality and Volume Balance Adjustment	7-39
System Settings	7-40
Troubleshooting	7-44
Antenna	7-46
Clock (if so equipped)	7-46
General information about your radio	7-47

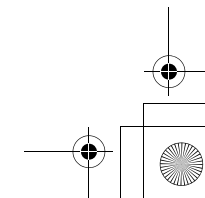
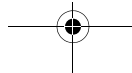
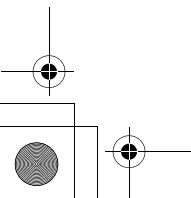
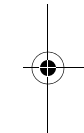
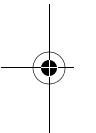

Vents

Vents

N00729900210

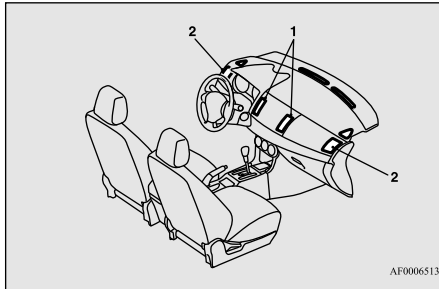

AF0006513

7

- 1- Center vents
- 2- Side vents

Air flow and direction adjustments

N00730200255

Center vents

Move the knob to make adjustments.
To close the vent, move the knob to the inside as far as possible.

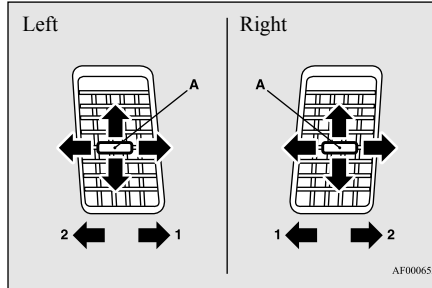

AF0006526

- A- Knob
- 1- Close
- 2- Open

Side vents

Move the knob to make adjustments.
To close the vent, move the knob to the outside as far as possible.

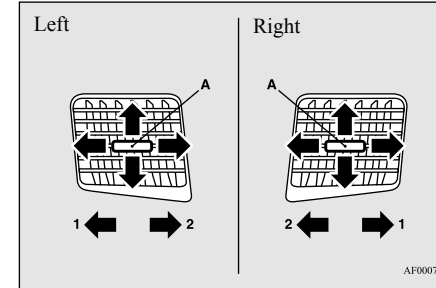

AF0007985

- A- Knob
- 1- Close
- 2- Open

NOTE

- On rare occasions, air from the vents of an air-conditioned vehicle may be foggy. This is only moist air cooling suddenly and does not indicate a problem.
- Do not let drinks or other liquids get into the vents as they could prevent the air conditioning from operating normally.

Changing the mode selection

N00736401650

To change the position and amount of air flowing from the vents, turn the mode selection dial. Refer to "Mode selection dial" on page 7-5.

Vents

These symbols are used in the next several illustrations to demonstrate the quantity of air coming from the vents.

- : Small amount of air from the vents
- ➔ : Medium amount of air from the vents
- ➔➔ : Large amount of air from the vents

Face position

Air flows only to the upper part of the passenger compartment.

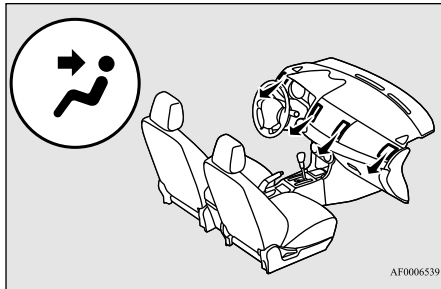

Foot/Face position

Air flows to the upper part of the passenger compartment, and flows to the leg area.

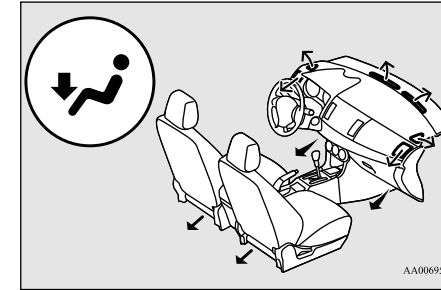
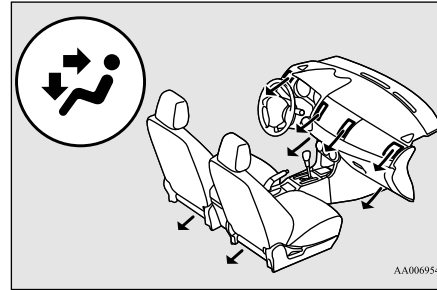

NOTE

- With the mode selection dial between the “” and “” positions, air flows mainly to the upper part of the passenger compartment. With the mode selection dial between the “” and “” positions, air flows mainly to the leg area.

Foot position

Air flows mainly to the leg area.



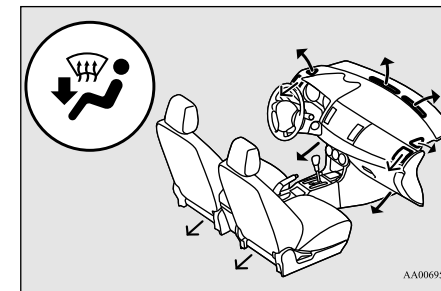

Foot/Defroster position

Air flows to the leg area, the windshield and the door windows.



Automatic air conditioning

NOTE

- With the mode selection dial between the “” and “” positions, air flows mainly to the leg area. With the mode selection dial between the “” and “” positions, air flows mainly to the windshield and the door windows.

Defroster position

7

Air flows mainly to the windshield and the door windows.

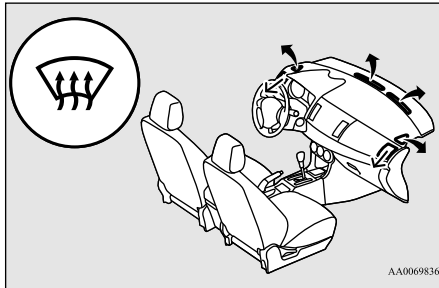

AA0069836

Automatic air conditioning

N00731501337

The air conditioning can only be used while the engine is running.

7-4 Comfort controls

Control panel

N00711801581

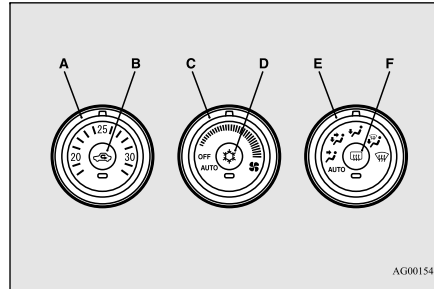

AG0015408

- A- Temperature control dial
- B- Air selection switch
- C- Blower speed selection dial
- D- Air conditioning switch
- E- Mode selection dial
- F- Electric rear window defogger switch
→P. 5-128

NOTE

- There is an interior air temperature sensor (G) in the illustrated position. Never place anything over the sensor, since doing so will prevent it from functioning properly.

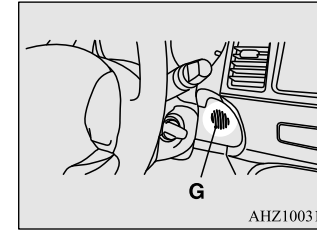

AHZ100310

Blower speed selection dial

N00736900111

When the ignition switch is in the “ON” position, select the blower speed by turning the blower speed selection dial.

Turning the dial clockwise will increase the blower speed; turning the dial counterclockwise will decrease it. When the dial is set to the “OFF” position, all fan-driven airflow will stop.

Automatic air conditioning

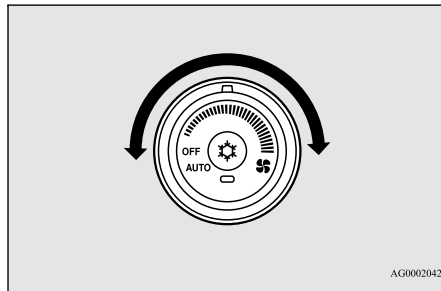

AG0002042

Temperature control dial

N00737000278

Use this dial to adjust the temperature in the passenger compartment. Turn the temperature control dial clockwise to make the air warmer. Turn it counterclockwise to make the air cooler.

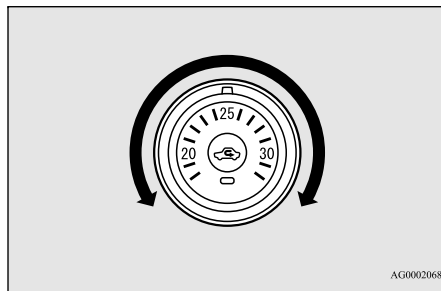

AG0002068

NOTE

- While the engine coolant temperature is low, the temperature of the air from the heater will be cool/cold until the engine warms up, even if you have selected warm air with the dial.
- When the temperature is set to the highest or the lowest setting under the AUTO operation, the air selection and the air conditioning will be automatically changed as follows. Also, if the air selection is operated manually after an automatic changeover, manual operation will be selected.
 - Quick Heating (When the temperature is set to the highest setting)
 - Outside air will be introduced and the air conditioning will stop.
 - Quick Cooling (When the temperature is set to the lowest setting)
 - Inside air will be recirculated and the air conditioning will operate.

The above indicates the factory settings. You can personalize the air selection switch and air conditioning switch to match your personal preferences.

Contact your Mitsubishi Motors dealer or a repair facility of your choice for assistance. Refer to “Personalizing the air conditioning switch (Changing the function setting)” on page 7-7.

Refer to “Personalizing the air selection (Changing the function setting)” on page 7-6.

Mode selection dial

N00737100136

To change the amount of air flowing from the vents, turn the mode selection dial. Refer to “Changing the mode selection” on page 7-2.

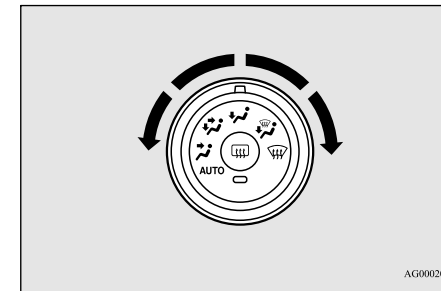

AG0002071

Air selection switch

N00737200241

Normally, use the outside air position to keep the windshield and side windows clear and to quickly remove fog or frost from the windshield.

To change the air selection, simply press the air selection switch. A sound will be made every time you press the switch.

- Outside air {Indicator light (A) OFF}
 - Outside air is introduced into the passenger compartment.

Comfort controls 7-5

Automatic air conditioning

- Recirculated air {Indicator light (A) ON}
Air is recirculated inside the passenger compartment.

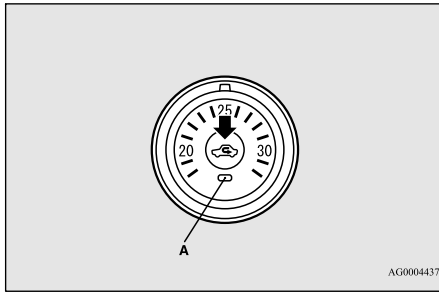

When the air conditioning turns on, the air selection is controlled automatically. When the air conditioning turns off, the air selection automatically goes back to the outside air position.

If high cooling performance is desired, or if the outside air is dusty or contaminated in some way, use the recirculation position. Switch to the outside air position every now and then to keep the windows from fogging up.

CAUTION

- Using recirculated air for a long time may cause the windows to fog up.

Personalizing the air selection (Changing the function setting)

N0076000076

You can change the following functions to match your preference.

- Enable automatic air control:
When the mode selection dial or the blower speed selection dial is set to the “AUTO” position, the air selection switch will also be automatically controlled.
- Disable automatic air control:
Even when the mode selection dial or the blower speed selection dial is set to the “AUTO” position, the air selection switch will not be automatically controlled.
- Changing the settings:
Press the air selection switch for about 10 seconds or longer.
When the setting has changed, the system will beep and the indicator light will flash.
 - When the setting has changed from enabled to disabled, the system will beep three times and the indicator will flash three times.
 - When the setting has changed from disabled to enabled, the system will beep two times and the indicator light will flash three times.

NOTE

- The factory setting is “Enable automatic air control”.
- While the mode selection dial is set to the “OFF” position, the air selection will automatically change to the outside air position, even if the system is set to “Disable automatic air control”, in order to prevent windows from fogging up.

Air conditioning switch

N00737301366

Push the switch, and the air conditioning compressor will turn on. The air conditioning indicator light (A) will come on.

A sound will be made every time you push the switch.

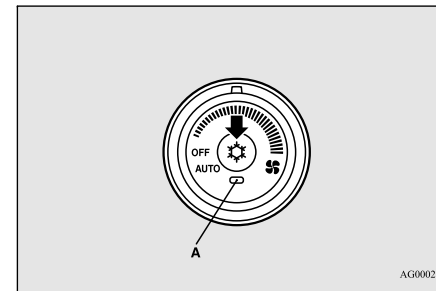

Automatic air conditioning

Push the switch again and the air conditioning compressor will stop and the indicator light (A) goes off.

CAUTION

- When using the air conditioning, the idling speed may slightly increase as the air conditioning compressor is switched on/off automatically. Especially for vehicles equipped with a continuously variable transmission (CVT) while the vehicle is stationary, fully depress the brake pedal to prevent the vehicle from creeping.

NOTE

- If a problem is detected in the air conditioning compressor, the air conditioning indicator light (A) blinks. Press the air conditioning switch once to turn it off, then once more to turn it back on. If the air conditioning indicator light does not blink there is no problem. If it does blink, have it checked at an authorized Mitsubishi Motors dealer or a repair facility of your choice.
- Sometimes, for example after using a high-pressure car wash, the condenser can get wet, and the air conditioning indicator light (A) blinks temporarily. Wait for a while, press the air conditioning switch once to turn the system off, then once more to turn it back on. Once the water evaporates, the blinking will stop.

Personalizing the air conditioning switch (Changing the function setting)

N0075980087

You can change the following functions to match your preference.

- Enable automatic air conditioning control:**
When the mode selection dial or blower speed selection dial has been set to the "AUTO" position or when the temperature control dial has been set to the minimum temperature, the air conditioning switch is automatically controlled.
- Disable automatic air conditioning control:**
The air conditioning switch is not automatically controlled, unless the air conditioning switch is used.
- Changing the settings:**
Press the air conditioning switch for about 10 seconds or longer.
When the setting has changed, the system will beep and the indicator light will flash.
 - When the setting has changed from enabled to disabled, the system will beep three times and the indicator will flash three times.
 - When the setting has changed from disabled to enabled, the system will beep two times and the indicator light will flash three times.

NOTE

- The factory setting is "Enable automatic air conditioning control".
- While the mode selection dial is set to the "OFF" position, the air conditioning will run automatically, even if the system is set to "Disable automatic air conditioning control", in order to prevent windows from fogging up.

Operating the air conditioning system (automatic mode)

N00731701397

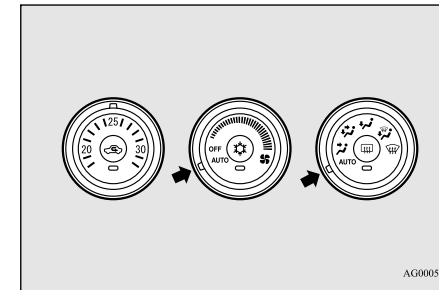

AG0005072

In normal conditions, use the system in the AUTO mode and follow these procedures:

- Set the blower speed selection dial to the "AUTO" position.

Automatic air conditioning

2. Select the temperature control dial to the desired temperature. The temperature can be set within a range of around 18 to 32. The temperature will increase as the dial is turned to the right.
3. Set the mode selection dial to the “AUTO” position.

The vents, recirculation/outside air, blower speed, and ON/OFF of air conditioning will be controlled automatically.

7

NOTE

- Set the temperature at about 25 under normal conditions.
- While the engine coolant temperature is low, the temperature of the air from the heater will be cool/cold until the engine warms up, even if you have selected warm air with the dial. To prevent the windshield and windows from fogging up, the vent mode will be changed to “

Operating the air conditioning system (manual mode)

N0073180098

Blower speed and vent mode may be controlled manually by setting the blower speed selection dial and the mode selection dial to the desired positions. To return to automatic

7-8 Comfort controls

operation, set the dials to the “AUTO” position.

Defrosting or defogging (windshield, door windows)

N00732400453

CAUTION

- For safety, make sure you have a clear view through all the windows.

To remove frost or mist from the windshield and door windows, use the mode selection dial (“

For ordinary defrosting

Use this setting to keep the windshield and door windows clear of mist, and to keep the leg area heated (when driving in rain or snow).

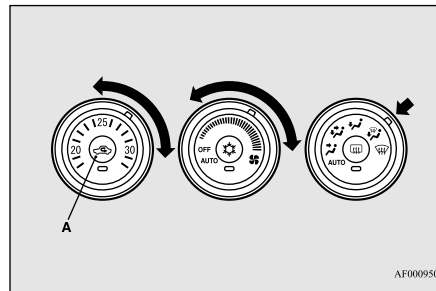

AF0009501

1. Set the mode selection dial to the “

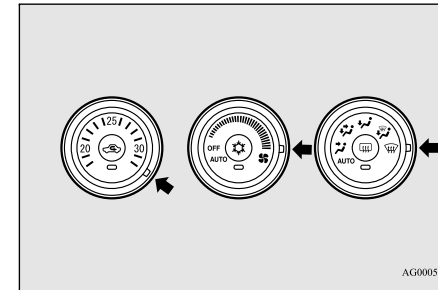

For quick defrosting



AG0005098

1. Set the mode selection dial to the “

NOTE

- While the mode selection dial is set to the “” position, the air conditioning compressor will run automatically. The outside air position will also be selected automatically.
- While the “” position is selected, you cannot turn the air conditioning off or select the recirculation position. This prevents the windows from fogging up.
- To defog quickly, direct the air flow from the side vents toward the door windows.
- When defrosting, do not set the temperature control dial to the maximum cool position. This will blow cool air on the window glass and fog it up.

Important air conditioning operating tips

N00733700280

1. Park the vehicle in the shade whenever possible. Parking in the hot sun makes the vehicle interior extremely hot which then requires more time to cool. If it is necessary to park in the sun, open the windows for the first few minutes of air conditioning to expel the hot air.
2. Afterwards, keep the windows closed when the air conditioning is in use. The entry of outside air through open windows will reduce cooling efficiency.

3. When running the air conditioning, make sure the air intake, which is located in front of the windshield, is free of obstructions such as leaves. Leaves collected in the air-intake chamber may reduce air flow and plug the water drains.

Air conditioning system refrigerant and lubricant recommendations

If the air conditioning seems less effective than usual, the cause might be a refrigerant leak.

Have the system inspected by your authorized Mitsubishi Motors dealer or a repair facility of your choice.

Important air conditioning operating tips

CAUTION

- The air conditioning system in your vehicle must be charged with the refrigerant HFC-134a and the lubricant SUN-PAG56. Use of any other refrigerant or lubricant will cause severe damage and may require replacing your vehicle's entire air conditioning system. The release of refrigerant into the atmosphere is not recommended. The new refrigerant HFC-134a in your vehicle is designed not to harm the earth's ozone layer. However, it may contribute slightly to global warming. It is recommended that the old refrigerant be saved and recycled for future use.

7

During a long period of disuse

The air conditioning should be operated for at least five minutes each week, even in cold weather. This includes the quick defrosting mode. Operating the air condition system weekly maintains lubrication of the compressor internal parts to keep the air conditioning in the best operating condition.

Air purifier

N00733800151

The air conditioning system is equipped with an air filter to remove pollen and dust.

Comfort controls 7-9

AM/FM radio/CD player (if so equipped)

The air filter's ability to collect pollen and dirt is reduced as it becomes dirty, so replace it periodically. For the maintenance interval, refer to the "WARRANTY AND MAINTENANCE MANUAL".

NOTE

- Operation in certain conditions such as driving on a dusty road and frequent use of the air conditioning can lead to reduction of service life of the filter. When you feel that the air flow is lower than normal or when the windshield or windows start to fog up easily, replace the air filter.
Contact your Mitsubishi Motors dealer or a repair facility of your choice for assistance.

7

AM/FM radio/CD player (if so equipped)

N00734302098

The audio system can only be used when the ignition switch is in the "ON" or "ACC" position.

NOTE

- To listen to the audio system while the engine is not running, turn the ignition switch to the "ACC" position.
If the ignition switch is left in the "ACC" position, the accessory power will automatically turn off after a certain period of time and you will no longer be able to use the audio system. The accessory power comes on again if the ignition switch is turned from the "ACC" position. Refer to "ACC power auto-cutout function" on page 5-52.
- If a cellular phone is used inside the vehicle, it may create noise in the audio equipment. This does not mean that anything is wrong with your audio equipment. In such a case, use the cellular phone at a place as far away as possible from the audio equipment.
- If foreign objects or water get into the audio equipment, or if smoke or a strange odor comes from it, immediately turn off the audio system and have it checked at an authorized Mitsubishi Motors dealer or a repair facility of your choice. Never try to repair it yourself. Avoid using the audio system until it is inspected by a qualified person.
- If the audio system is damaged by foreign objects, water, or fire, have the system checked by a qualified Mitsubishi Motors technician.

NOTE

- The audio amplifier (if so equipped) is located under the front left seat.
Do not subject the amplifier to a strong impact.
It could damage the amplifier or malfunctioning could result.

Important Points on Usage

N00715000021

iPod/iPhone Playback Function (if so equipped)

- This product supports audio playback from iPod/iPhone devices, however differing versions mean that playback cannot be guaranteed.
- Please be aware that depending on the iPod/iPhone model or version, operation may differ.

How to Clean

N00715200023

- If the product becomes dirty, wipe with a soft cloth.
- If very dirty, use a soft cloth dipped in neutral detergent diluted in water, and then wrung out. Do not use benzene, thinners, or other chemical wipes. This may harm the surface.

AM/FM radio/CD player (if so equipped)

Trademarks

N00715300079

- Product names and other proper names are the trademarks or registered trademarks of their respective owners.
- Furthermore, even if there is no specific denotation of trademarks or registered trademarks, these are to be observed in their entirety.



“Made for iPod”, “Made for iPhone” mean that an electronic accessory has been designed to connect specifically to iPod or iPhone, respectively, and has been certified by the developer to meet Apple performance standards. iPhone, iPod, iPod classic, iPod nano, and iPod touch are trademarks of Apple Inc., registered in the U.S. and other countries. Apple is not responsible for the operation of this device or its compliance with safety and regulatory standards.

NOTE











- iPod and iTunes licensing allows individual users to privately reproduce and play back non-copyrighted material as well as material that may be legally copied and reproduced. Infringement of copyright is prohibited.

NOTE

- For vehicles with a Bluetooth® 2.0 interface, the types of devices that can be connected may vary.
[For vehicles sold in U.S.A.]
For details, access the Mitsubishi Motors North America website.
[For vehicles sold in Canada]
For details, access the Mitsubishi Motors website. Please read and agree to the “Warning about Links to the Web Sites of Other Companies”. The websites mentioned above may connect you to websites other than the Mitsubishi Motors website.
<http://www.mitsubishi-motors.com/en/products/index.html>

AM/FM radio/CD player (if so equipped)

7

iPod		iPod classic		
				
iPod 5th generation (video) 60GB 80GB	iPod 5th generation (video) 30GB	iPod classic 160GB (2009)	iPod classic 160GB (2007)	iPod classic 80GB
iPod nano				
				
iPod nano 6th generation 8GB 16GB	iPod nano 5th generation (video camera) 8GB 16GB	iPod nano 4th generation (video) 8GB 16GB		
				
iPod nano 3rd generation (video) 4GB 8GB	iPod nano 2nd generation (aluminum) 2GB 4GB 8GB	iPod nano 1st generation 1GB 2GB 4GB		

AA5013326

Handling of Discs

iPod touch



iPod touch

4th generation
8GB 32GB 64GB



iPod touch

3rd generation
32GB 64GB



iPod touch

2nd generation
8GB 16GB 32GB



iPod touch

1st generation
8GB 16GB 32GB

7

iPhone



iPhone 4S

16GB 32GB 64GB



iPhone 4

16GB 32GB

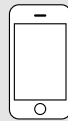

iPhone 3GS

8GB 16GB 32GB



iPhone 3G

8GB 16GB

AJ5100128

Handling of Discs

N00715400025

This explains care that should be taken in the handling of discs.

Comfort controls 7-13

Handling of Discs

Important Points on Handling

- Fingerprints or other marks on the read surface of the disc may result in its content being more difficult to read. When holding the disc, grip both edges, or one edge and the center hole, in order that the read surface is not touched.
- Do not affix paper or stickers, or otherwise damage the disc.
- Do not forcefully insert a disc if another is already within the device. This can result in damage to discs, or malfunction.

7

Cleaning

- Periodically clean the read surface of the disc. When cleaning, do not wipe in a circular motion. Instead, wipe gently outwards from the center of the disc to the outer edge.
- New discs may have burring around the outer edge or in the hole in the center. Ensure you check for these. If there are burrs, these may lead to faulty operation, therefore ensure these are removed.

Important Points on Storage

- When not using discs, ensure these are kept in cases, and stored out of direct sunlight.

7-14 Comfort controls

- If discs are not going to be used for a long period of time, remove these from the product.

Disc Playback Environment

In cold environments such as in mid-winter when the interior of the vehicle is cold, turning the heater on and immediately trying to use the product may cause condensation (water droplets) to form on the disc and internal optical components, and this may prevent the product from operating correctly.

In these conditions, remove the disc, and wait a short time before use.





Copyright

Actions such as unauthorized reproduction, broadcast, public performance, or rental of discs that comprise other than personal use are prohibited by law.

Types of Disc That Can Be Played Back

N00715500026

The following marks are printed on the disc label, package, or jacket.

Type	Size	Maximum playback time	Comments
CD-DA 	5 inches (12 cm)	74 minutes	—
CD-TEXT 	5 inches (12 cm)	74 minutes	—
CD-R/RW  	5 inches (12 cm)	—	•Disc containing MP3 files

Discs That May Not Be Played Back

- Playback of discs other than those described in “Types of Disc That Can Be Played Back” is not guaranteed.
- 3 inches (8 cm) discs may not be used.
- Do not insert irregularly-shaped discs (for example, heart-shaped), as these may result in malfunction. Additionally, discs that have transparent portions may not be played back.

Audio Files (MP3/WMA/AAC)

- Discs that have not been finalized cannot be played back.
- Even if recorded using the correct format on a recorder or computer, application software settings and environments; disc peculiarities, damage, or marking; or dirt or condensation on the lens inside the product may render the disc unplayable.
- Depending on the disc, some functions may not be used, or the disc may not play back.
- Do not use discs with cracks or warps.
- If the disc has stickers affixed, remains from removed stickers, or affixed adhesive, then do not use the disc.
- Discs that have decorative labels or stickers may not be used.
- There may be noise during playback.
- There may be jumping in the audio.
- The disc may not be recognized.
- The first track may not be played back.
- It may take longer than usual until start of playback of tracks.
- Playback may start from within the track.
- Some parts may not be played back.
- Tracks may freeze during playback.
- Tracks may be displayed erroneously.

Audio Files (MP3/WMA/AAC)

N00715600027

This product can play back MP3/WMA/AAC format audio files recorded on CD-ROM, CD-R/RW, and USB devices.

There are limitations on the files and media that can be used, therefore read the following prior to recording MP3/WMA/AAC format audio files on discs or USB devices.

Additionally, ensure you read the user manuals for your CD-R/RW drive and the writing software, and ensure these are used correctly. If the MP3/WMA/AAC format audio files includes title information or other data, then this can be displayed.

Nonstandard CDs

This product will play back audio CDs, however please be aware of the following points regarding CD standards.

- Ensure that you use discs with **disc** on the label surface.
- Playback of other than standard CDs is not guaranteed. Even if the audio can be played back, the audio quality cannot be guaranteed.
- When playing back other than standard CDs, the following may occur.

CAUTION

- CD-ROM and CD-R/RW media can only play back MP3 format audio files.
- Actions such as copying audio CDs or files and either distributing these to others for free or for charge, or uploading files via the Internet or other means to servers is an infringement of the law.
- Do not append the file extensions “.mp3”, “.wma”, or “.m4a”, to other than MP3/WMA/AAC format files. Playing back discs with these types of files recorded upon them may cause the files to be incorrectly identified for playback, which may lead to loud noise, resulting in speaker damage or accident.

NOTE

- Depending on the condition of the disc recorder or recording software used, correct playback may not be possible. In these cases, refer to the user manual for your product or software.
- Depending on your computer's operating system, version, software, or settings, files may not have a file extension appended. In these cases, append the file extensions “.mp3”, “.wma”, or “.m4a” when copying the files.
- Files larger than 2GB in size cannot be played back.

Audio Files (MP3/WMA/AAC)

Data Formats That Can Be Played Back

N00715700028

Data formats that can be played on discs (CD-ROM, CD-R/RW) and USB devices differ.

Data format	DISC	USB device
MP3	○	○
WMA	X	○
AAC	X	○

7

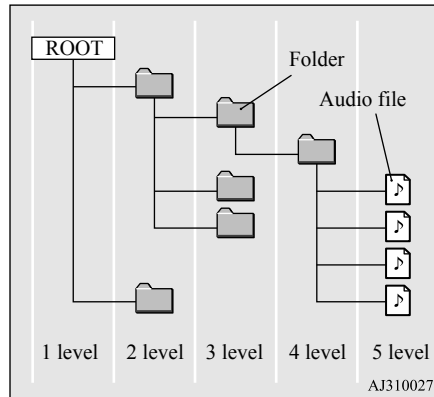

Folder Structure

N00715800029

Up to 8 folder levels can be recognized. You can create a folder structure as in Genre - Artist - Album - Track (MP3/WMA/AAC format audio files) for management of tracks.

Name	Specification	Explanation	
Format specifications	ISO9660	Level 1	Maximum 8 character file name, and 3 character file extension. (single-byte alphanumeric capital letters, numerals, “_” may be used)
	ISO9660 extension	Joliet	Files names up to a maximum 64 characters can be used.
Multisession	Not supported (only first session supported)		
Maximum number of levels	8 levels (if the root is the 1st level)		
Maximum folder number	700 folders (including root)		

Audio Files (MP3/WMA/AAC)

Name	Specification	Explanation
Maximum file number* ¹	65,535 files (total number on media. Other than MP3, WMA, and AAC files not included)	
File name and folder name restrictions	Maximum 64 bytes (for Unicode, 32 characters), files/ folders with file/ folder names longer than this will not be displayed or played back.	
USB supported formats	The recommended file system is FAT32. 1 partition only	

*¹. Do not include other than MP3/WMA/AAC files. However, if storing many tracks within the same folder, these may not be recognized even if less than the maximum number of tracks. In these cases, divide the tracks up into multiple folders.

 NOTE
<ul style="list-style-type: none"> The order in which folders and audio files are displayed on this product may be different to how they are displayed on a computer.

What Is MP3?

N00715900020

MP3 is an abbreviation of “MPEG-1 Audio Layer 3”. MPEG is an abbreviation of “Motion Picture Experts Group”, and this is a video compression standard used in video CDs, etc.

MP3 is one of the audio compression methods contained in the MPEG audio standard, and reduces the quality of sounds that are beyond the auditory resolution of the human ear and that are hidden by louder sounds, thus creating high-quality data with a lower data size.

Because this can compress CD audio to approximately 1/10 its original data size without perceptible loss, approximately 10 CDs can be written to a single CD-R/RW disc.

 **CAUTION**

- MP3 files different to the standards at right may not play back correctly, or file/folder names may not be displayed correctly.

Standards for MP3 Files That Can Be Played Back

Specifications for MP3 files that can be played are as below.

Item	Details
Specification	MPEG-1 AUDIO LAYER3
	MPEG-2 AUDIO LAYER3
Sampling frequency [kHz]	MPEG-1: 32/44.1/48
	MPEG-2: 16/22.05/24
Bit rate [kbps]	MPEG-1: 32 to 320
	MPEG-2: 8 to 160
VBR (variable bit rate)	Support
Channel mode	Stereo/ Joint stereo/ Dual channel/ Monaural
File extension	mp3
Supported tag information	ID3 tag Ver. 1.0, Ver. 1.1, Ver. 2.2, Ver. 2.3, Ver. 2.4 (ISO-8859-1, UTF-16 (Unicode)), Titles, Artist name, Album name
Maximum number of characters that can be indicated on the display	64 characters

Audio Files (MP3/WMA/AAC)

What Is WMA?

N0071600028

WMA is an abbreviation of Windows Media Audio, and this is an audio compression format from Microsoft. This is a compression format that has a higher compression ratio than MP3.

NOTE

- Microsoft, Windows Media, and Windows are registered trademarks of Microsoft Corporation (USA) and in other countries.

7

CAUTION

- WMA supports digital rights management (DRM). This product cannot play back WMA files protected using this system.
- WMA files different to the standards at right may not play back correctly, or file/folder names may not be displayed correctly.
- “Pro”, “Lossless”, and “Voice” are not supported.

Standards for WMA Files That Can Be Played Back

Specifications for WMA files that can be played are as below.

Item	Details
Specification	Windows Media Audio Version7.0/8.0/9.0
Sampling frequency [kHz]	32/44.1/48
Bit rate [kbps]	48 to 320
VBR (variable bit rate)	Support
Channel mode	Stereo/Monaural
File extension	wma
Supported tag information	WMA tags Title name, Artist name, Album name
Maximum number of characters that can be indicated on the display	64 characters

What Is AAC?

N00716100029

AAC is an abbreviation of Advanced Audio Coding, and this is an audio compression standard used in “MPEG-2” and “MPEG-4”. This features 1.4x the compression of MP3, with comparable audio quality.

CAUTION

- AAC supports digital rights management (DRM). This product cannot play back AAC files protected using this system.
- AAC files different to the standards at right may not play back correctly, or file/folder names may not be displayed correctly.

Standards for AAC Files That Can Be Played Back

Specifications for AAC files that can be played are as below.

Item	Details	
Specification	Advanced Audio Coding MPEG4/AAC-LC MPEG2/AAC-LC	
Sampling frequency [kHz]	MPEG4	8/11.025/12/16/22.05/24/32/44.1/48
	MPEG2	8/11.025/12/16/22.05/24/32/44.1/48
Bit rate [kbps]	MPEG4	8 to 320
	MPEG2	8 to 320
VBR (variable bit rate)	Support	
Channel mode	Stereo/Monaural	

Important Points on Safety for the Customer

Item	Details
File extension	m4a
Supported tag information	AAC tags or ID3 tags Title, Artist name, Album name
Maximum number of characters that can be indicated on the display	64 characters

Important Points on Safety for the Customer

N00716200020

This product features a number of pictorial indications as well as points concerning handling so that you can use the product correctly and in a safe manner, as well as prevent injury or damage to yourself, other users, or property.

⚠ WARNING

- The driver should not pay close attention to the display while driving. This may prevent the driver looking where they are going, and cause an accident.

⚠ WARNING

- The driver should not perform complicated operations while driving. Performing complicated operations while driving may prevent the driver looking where they are going, and cause an accident. Therefore stop the vehicle in a safe location before performing such operations.
- Do not use during malfunctions, such as when no sound is audible. This may lead to accident, fire, or electric shock.
- Ensure water or other foreign objects do not enter the product. This may lead to smoking, fire, electric shock, or malfunction.
- Do not insert foreign objects into the disc slot. This may lead to fire, electric shock, or malfunction.
- In the event of abnormalities occurring when foreign objects or water enter the product, resulting in smoke or a strange smell, immediately stop using the product, and consult an authorized Mitsubishi Motors dealer or a repair facility of your choice. Continuing to use the product may result in accident, fire, or electric shock.
- Do not disassemble or modify the product. This may lead to malfunction, fire, or electric shock.

⚠ WARNING

- During thunderstorms, do not touch the antenna or the front panel. This may lead to electrical shock from lightning.

⚠ CAUTION

- Do not block ventilation holes or heat sinks on the product. Blocking ventilation holes or heat sinks may prevent heat from escaping from within the product, leading to fire or malfunction.
- Do not turn the volume up to the extent that you cannot hear sounds from outside the vehicle while driving. Driving without being able to hear sounds from outside the vehicle may result in an accident.
- Do not insert your hand or fingers into the disc slot. This may result in injury.

7

Operation Keys

N00716300021

Turn the Power ON/ OFF

N00716400022

1. Press the PWR/VOL key.

Operation Keys

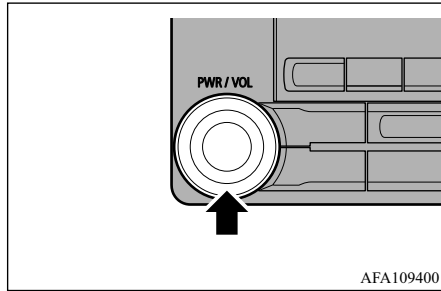

7

- Turn the power on, and resume playback from the previous status.
- Press the PWR/VOL key.
Turn the power OFF.

NOTE

- Hold down the steering MODE key to also turn the audio function ON/OFF.

Adjust Volume

N0071650023

- Turn the PWR/VOL key to adjust the volume.

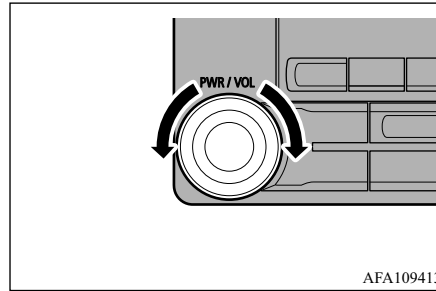

Turn the PWR/VOL key clockwise to increase, and counter-clockwise to decrease the volume.

NOTE

- The maximum value for volume is 45, and the minimum is 0.
- The initial setting for volume is "17".

Insert/Eject Discs

N0071660024

- Insert the disc into the disc slot with the label surface up.

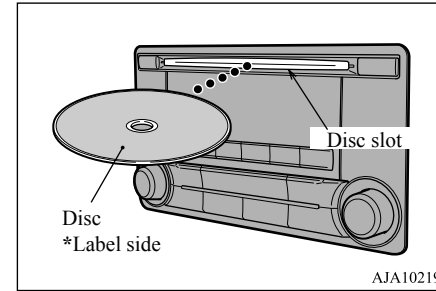

Push the disc in a certain amount, and the product will pull the disc in, and playback will start.

- Press the ▲ key.
This will eject the disc from the product, so remove the disc.

CAUTION

- When replacing discs, first ensure that the vehicle is stopped in an area in which stopping is permitted.
- Do not insert your hand, fingers, or foreign objects into the disc slot. This may lead to injury, smoking, or fire.
- 3 inches (8 cm) CDs are not supported.

Explanation of Buttons

N00716700096

This explains names and functions of each part.

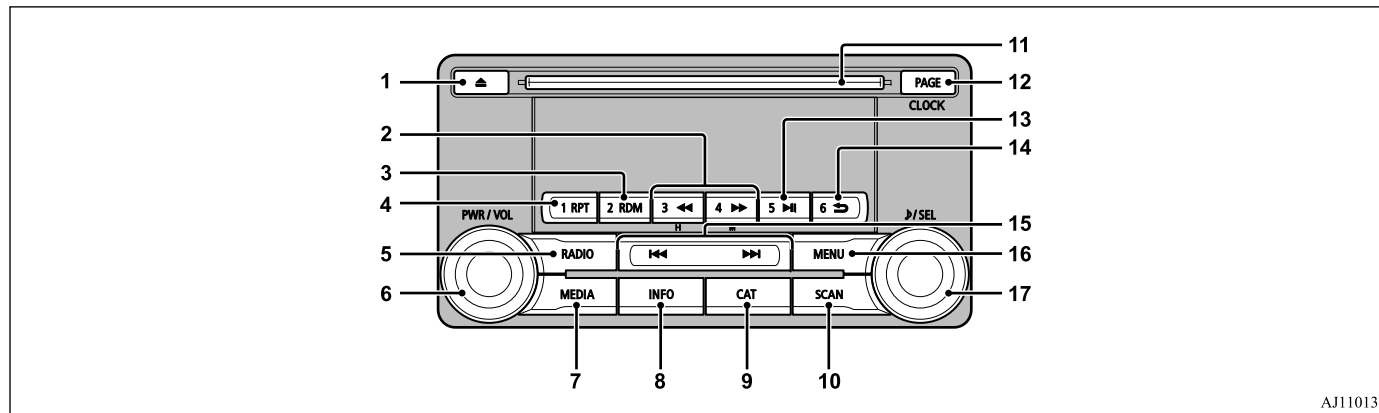

AJ1101387

- | | | |
|---|---|--|
| <p>1- ▲ key
Use to eject a disc.</p> <p>2- 3 ◀◀ key/4 ▶▶ key
For audio, rewind/fast forward.
For radio, use as preset keys 3 and 4.</p> <p>3- 2RDM key
For audio, play random playback; for radio, use as preset key 2.</p> <p>4- 1RPT key
For audio, play repeat playback; for radio, use as preset key 1.</p> | <p>5- RADIO key
Switch the radio and the band.</p> <p>6- PWR/VOL key
Adjust the volume, and turn the power ON/OFF.</p> <p>7- MEDIA key
Switch between CD and other sources.</p> <p>8- INFO key
Switch the content of the display.</p> | <p>9- CAT key
CAT (category content) searches and scans can be performed while receiving radio RBDS broadcasts.
Search channels in the satellite radio*¹.</p> <p>10- SCAN key
For audio, play scan playback; for radio, scan for stations.</p> <p>11- Disc slot</p> <p>12- PAGE key
Display indicator page advance.</p> |
|---|---|--|

Operation Keys

13- 5 key

Play/Pause Bluetooth Audio*², and use as preset key 5 for radio.

14- 6 key

Return during audio track search, and stop Bluetooth Audio*².
For radio, use as preset key 6.

15- key/ key

For audio, select audio track/file; for radio, perform automatic station selection.

Select channels in the satellite radio*¹.

16- MENU key

Switch to Menu mode.

17- /SEL key

Adjust audio quality and select items.
For radio, manually select stations.
Select channels in the satellite radio*¹.

*¹: Requires a satellite tuner connection.

*²: Requires a separately-purchased Bluetooth-capable audio device in equipment by type (vehicles with a Bluetooth[®] 2.0 interface).

Steering wheel audio remote control switches

N00716800055

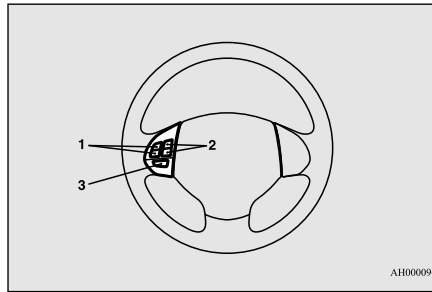

AH0000966

1- Vol + key, - key

Adjust audio functions and the mobile phone function volume.

2- CH key, key

Select CD and other audio source tracks and radio stations.

Hold down to skip up and down through tracks.

Hold down to switch the satellite radio band during satellite radio reception.

3- MODE key

Hold down to turn the audio function ON/OFF. Additionally, each time this is pressed, this switches the audio source.

The order of switching is as shown below.

If devices are not connected, then these are to be skipped, and the next source selected.

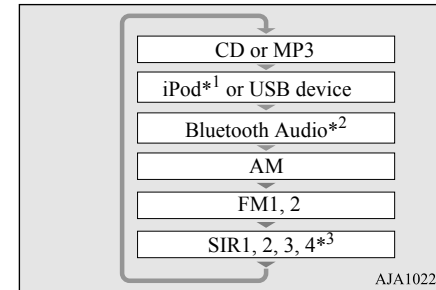

AJA102201

*¹: An iPod cable (available separately) is required.

*²: Requires a separately-purchased Bluetooth-capable audio device (vehicles with a Bluetooth[®] 2.0 interface).

*³: Requires a satellite tuner connection.

Listen to Radio

Listen to Radio

N00716900085

This explains how to listen to AM and FM radio broadcasts.

To Listen to the Radio

Press the RADIO key to switch the band.

Switch between AM and FM bands.
The selected band is indicated on the display.

NOTE

- Bands switch in the order AM, FM1, FM2, SIR1*, SIR2*, SIR3*, and SIR4*.
- If no signal is received, bands will not be switched to SIR2, SIR3, or SIR4.

*: When a satellite tuner is connected

Manual/Seek Station Selection

Turn the **▷/SEL** key to the frequency to listen to.

▷/SEL key (counter-clockwise)	Reduces the frequency being received.
---	---------------------------------------

▷/SEL key (clockwise)	Increases the frequency being received.
▶▶ key (hold down)	Release the button to start seek station selection, and when a station is received, scanning stops.
 ◀◀ key (hold down)	

Scan Station Selection

Collective search for stations that can be received.

Press the SCAN key.

When a station is received, this is played for 5 seconds, then the product searches for the next station.

NOTE

- Press this button again while receiving the station to return to normal reception.

Preset Memory

Register the broadcast station in advance, and select this at a later time.

1. Tune in to the frequency to register.

2. Hold down any of the keys from the 1RPT key to the 6 **↔** key.

A “Beep” sounds, and the preset key is registered.

NOTE

- The preset memory can register a maximum of 6 stations for each band.
- If a preset key that already has a station registered is selected, then this is overwritten with the new preset.
- Pressing the preset key will select the previously registered frequency.

7

CAT Search

During RBDS broadcast reception, select CAT (category content), and automatically scan for stations.

1. During FM reception, press the CAT key.
This switches to the CAT selection mode.
2. Press the CAT key to select CAT.
3. Press the **|◀◀** key or **▶▶|** key.
The CAT (category content) indicator will flash, and station selection will automatically start.
When a station is received, the frequency is displayed.

Listen to Satellite Radio (if so equipped)

NOTE

- This receives the station detected first.
- 10 seconds after reception, CAT search mode will be cancelled.
- To receive a different station, press the **◀◀** key or **▶▶** key again.

CAT Scan

7

During RBDS broadcast reception, select CAT (category content) to perform a collective search for stations.

1. During FM reception, press the CAT key. This switches to the CAT selection mode.
2. Press the CAT key to select CAT.
3. Press the SCAN key.

When a broadcast station is received, this is played for 5 seconds, then the product searches for the next station.

NOTE

- Press this key again while receiving the station to return to normal reception.

Listen to Satellite Radio (if so equipped)

N00717000070

This section explains how to listen to satellite radio.

NOTE

- A subscription is required to listen to satellite radio. Satellite radio cannot be received after the free trial period has expired.
- If no subscription has been made when the free trial period expires, the display will alternate between “CALL” and “888-539-SIRI”.

To listen to Satellite Radio

Press the RADIO key to switch the band.

Switches between SIR1, SIR2, SIR3, and SIR4 bands.

The selected band is indicated on the display.

NOTE

- Bands switch in the order AM, FM1, FM2, SIR1, SIR2*, SIR3*, and SIR4*.
- Switch satellite radio bands by holding down the **▼** key or **▲** key on the steering remote control switch.

*:If no signal is received, bands will not be switched.

Select a Station

Press the **◀◀** key or **▶▶** key to select the station.

◀◀ key	Go down one step from the channel being received.
▶▶ key	Go up one step from the channel being received.
◀◀ key (Hold down)	While the key is held down, it will cycle down through the channels being received.
▶▶ key (Hold down)	While the key is held down, it will cycle up through the channels being received.

NOTE

- When cycling up/down through channels, the channel number display in the upper level of the display changes.
- When channel number “000” is selected, the SIRIUS ID (12 digits) is displayed.

Scan Station Selection

Channels are received in order and take 10 seconds each.

Scan All Channels

Press the SCAN key.

All of the channels are scanned.

NOTE

- Press this key again while receiving the channel to return to normal reception.
- Selecting a channel will cancel this.

Scan Category Channels

1. Press the CAT key.
Switches to the category search mode, and the category name is indicated on the display.
2. Turn the **▶/SEL** key to select the category.
3. Press the SCAN key.
The channels in the selected category are scanned.

NOTE

- Press the SCAN key or CAT key again while receiving the channel to return to normal reception.
- Turning the **▶/SET** key will cancel.

Preset Memory

Register the channel in advance, and select this at a later time.

1. Tune in to the channel to register.
2. Hold down any of the keys from the 1RPT key to the **6** **➡** key.
A “Beep” sounds, and the preset key is registered.

NOTE

- The preset memory can register a maximum of 6 stations per band.
- If a preset key that already has a channel registered is selected, then this is overwritten with the new preset.
- Pressing the preset key will select the previously registered channel.
The preset channels on the display are shown as “P1” though “P6”.

Listen to Satellite Radio (if so equipped)

Channel Search

Other channels can be selected while listening to a channel.

1. Press the CAT key.
Switches to the category search mode, and the category name is indicated on the display.
2. Turn the **▶/SEL** key to select the category.
3. Press the **▶/SEL** key.
Switches to channel search mode.
4. Turn the **▶/SEL** key to select the channel.
5. Press the **▶/SEL** key.
A “Beep” sounds, and the selected channel is received. (Channel preliminary setting mode)
The channel name shown on the display flashes.
Press the **▶/SEL** key again to cancel the search mode and return to normal reception.
6. To continue the search, turn the **▶/SEL** key to select the channel.
The selected channel is received.
7. Press the **▶/SEL** key.
Cancels the search mode and returns to normal reception.

Listen to CDs

NOTE

- After making preliminary settings in the channel search mode, this will switch to the channel being received.
- Channel number “000” is for the SIRUS ID display, so it cannot be searched.
- If the “CAT ALL” category is selected, all channels can be searched in the channel search mode.
- In the category mode, press the CAT key to cancel search mode.
- In the channel search mode, press the 6 ➡ key to return to the category search mode.
- In the channel preliminary setting mode, press the 6 ➡ key to return to the category search mode without returning to the previous channel search mode.
- If there is no operation for 10 seconds, the search mode will be cancelled.

7

Initialize the CODE (Passcode)

The CODE required for changing the LOCK settings in the satellite settings is initialized. (The factory setting is “1111”.)

When the power is off, press the PWR/VOL key while holding down the ▶/SEL key.
→ “Turn the Power ON/OFF” (P7-19)

Listen to CDs

N00717100026

This explains how to listen to audio CDs (CD-DA/CD-TEXT).

Play CDs

Insert the disc.

Insert a disc to automatically start playback.
→ “Insert/Eject Discs” (P.7-20)
If a disc is already within the product, press the MEDIA key to switch to CD as the source.

Select the Track

Press the ◀◀ key or ▶▶ key to select the track.

This enables selection of the next or previous track.

Fast Forward or Rewind

Hold down the 3◀◀ key or the 4▶▶ key.

Fast forward/rewind is possible.

Switch Playback Mode

Repeat playback, random playback, and scan playback are possible.

Repeat Playback (RPT)

Press the 1RPT key.

Repeat playback of the track currently being played.

NOTE

- Pressing again will cancel.
- Selecting a track, ejecting, fast forwarding, or rewinding will cancel.

Random Playback (RDM)

Press the 2RDM key.

Play the tracks on the disc in a random order.

NOTE

- Pressing again will cancel.
- Ejecting will cancel this.

Listen to MP3s

Scan Playback (SCAN)

Press the SCAN key.

Play the first 10 seconds of each of the tracks on the whole disc in order.

NOTE

- Press this button again during playback if you wish to hear that track, and that track will play normally.

Listen to MP3s

N00717200027

This explains how to listen to audio files on a disc.

CAUTION

- CD-ROM and CD-R/RW media can only play back MP3 format audio files.

To Listen to MP3s

Insert the disc.

Insert a disc to automatically start playback.
→ “Insert/Eject Discs” (P.7-20)

If a disc is already within the product, press the MEDIA key to switch to CD as the source.

NOTE

- Depending on the file structure, it may take some time to read the contents of the disc.

Select the Track (File)

Press the ◀◀ key or ▶▶ key to select the track.

This enables selection of the next or previous track.

Fast Forward or Rewind

Hold down the 3 ◀◀ key or the 4 ▶▶ key.

Fast forward/rewind is possible.

Switch Playback Mode

Repeat playback, random playback, and scan playback are possible.

Repeat Playback (RPT)

Press the 1RPT key.

Repeat playback of the track currently being played.

NOTE

- Pressing again will cancel.
- Selecting a file, ejecting, fast forwarding, or rewinding will cancel.

7

Folder Repeat Playback

Hold down the 1RPT key.

Repeat playback of the tracks within the folder currently being played.

NOTE

- Pressing again will cancel.
- Even if the file is selected, folder repeat playback will not be cancelled.

Random Playback (RDM)

Press the 2RDM key.

Listen to an iPod

Play the tracks in the folder in a random order.

NOTE

- Pressing again will cancel.

Folder Random Playback

Hold down the 2RDM key.

7

Play all tracks in folders on the disc in a random order.

NOTE

- Pressing again will cancel.

Scan Playback (SCAN)

Press the SCAN key.

Play the first 10 seconds of each of the tracks in the folder currently being played in order.



NOTE

- Press this button again during playback if you wish to hear that track, and that track will play normally.



7-28 Comfort controls

Search Tracks

Search folders and files, and select a track.





1. Turn the  /SEL key to select the folder.
2. Press the  /SEL key.

Files within the selected folder are displayed.

3. Turn the  /SEL key to select the file.
4. Press the  /SEL key.

This plays the selected file (track).

NOTE

- While the folder is selected, press the 6  key to cancel track search mode.
- If there is no operation for 10 seconds after selecting the folder, then track search mode will be cancelled.
- Select the folder, and hold down the  /SEL key to start playback from the first track in that folder.
- While the file is selected, press the 6  key to return to the previous operation.
- While the file is selected, hold down the 6  key to cancel track search mode.
- If there is no operation for five seconds after selecting the file, that file is played back.
- Disc operations such as selecting a track will cancel track search mode.

Listen to an iPod

N00717300057

By connecting commercially-available iPod/iPhone devices to this product, you can play back tracks on these through the product.

CAUTION

- Do not leave the iPod/iPhone unattended in the vehicle.
- Never hold these devices in your hand to operate while driving, as this is dangerous.
- No indemnification for data loss resulting when the iPod/iPhone is connected to the product will be possible.
- Depending on how the devices are handled, audio files being damaged or lost, therefore it is recommended that data be backed up.

NOTE

- Depending on the generation, model, or software version of the iPod/iPhone, playback on this product may not be possible. (→P.7-11) Additionally, playback as explained in this document may not be possible.

Listen to an iPod

 **NOTE**

- For vehicles with a Bluetooth® 2.0 interface, the types of devices that can be connected may vary.
[For vehicles sold in U.S.A.]
For details, access the Mitsubishi Motors North America website.
[For vehicles sold in Canada]
For details, access the Mitsubishi Motors website. Please read and agree to the “Warning about Links to the Web Sites of Other Companies”. The websites mentioned above may connect you to websites other than the Mitsubishi Motors website.
<http://www.mitsubishi-motors.com/en/products/index.html>
- Regarding how to connect the iPod/iPhone, refer to “How to connect an iPod” on page 5-152.
- When connecting the iPod/iPhone, use a commercially-available iPod connection cable.
- Set up the device in order that no unsafe actions, such as plugging in the connection cable are taken while driving.
- When inserting and removing the iPod/iPhone, for safety’s sake first stop the vehicle.
- Depending on the status of the iPod/iPhone, it may take some time until the device is recognized, or playback starts.
- Buttons on the product will not operate while iPod/iPhone is connected.

 **NOTE**

- iPod/iPhone specifications and settings may mean that connection is not possible, or result in differences in operation or display.
- Depending on audio data in the iPod/iPhone, track information may not be displayed correctly.
- Depending on the status of the vehicle and device, the iPod/iPhone may not play back after starting the engine.
- Data containing copyright information may not play back.
- It is recommended that the iPod/iPhone equalizer settings be set to flat.
- Operate the iPod/iPhone while connected to this product.
- If the iPod/iPhone is connected via Bluetooth as a Bluetooth-capable audio device, then do not connect the iPod/iPhone using an iPod cable. Connection using both methods will result in erroneous operation.
- If an iPod/iPhone does not operate correctly, then remove the iPod/iPhone from the product, reset, then reconnect.

Play iPod

Press the MEDIA key to set the iPod as the source.

The selected source is indicated on the display.

Select the Track (File)

Press the ◀◀ key or ▶▶ key to select the track.

This enables selection of the next or previous track.

Fast Forward or Rewind

Hold down the 3 ◀◀ key or the 4 ▶▶ key.

Fast forward/rewind is possible.

Switch Playback Mode

Repeat playback and shuffle playback are possible.

Repeat Playback (RPT)

Press the 1RPT key.

Repeat playback of the track currently being played.

 **NOTE**

- Pressing again will cancel.

Listen to Audio Files on a USB Device

Shuffle Playback (RDM)

Press the 2RDM key.

Play tracks in the category currently being played in a random order.

NOTE

- Pressing again will cancel.

7

Album Shuffle Playback

Hold down the 2RDM key.

Play back the album in a random order (tracks in any order on the album).





NOTE

- Pressing again will cancel.





Search Tracks

Search categories or track names, and select a track.

1. Turn the /SEL key to select the category.

2. Press the /SEL key. Categories or tracks within the selected category are displayed.
3. Turn the /SEL key to select the category or track.
4. Press the /SEL key. Repeat steps 1 to 4, and search for tracks. Select the track, and press the /SEL key to play.

NOTE

- While the category (1st level) is selected, press the  key to cancel track search mode.
- If there is no operation for 10 seconds after selecting the category, then track search mode will be cancelled.
- Select the category, and hold down the /SEL key to start playback from the first track in that category.
- While the track is selected, press the  key to return to the previous operation.
- While the track is selected, hold down the  key to cancel track search mode.
- If there is no operation for five seconds after selecting the track, that file is played back.
- iPod operations such as selecting a track will cancel track search mode.

Listen to Audio Files on a USB Device

N00717400074

By connecting commercially-available USB devices such as USB memory to this product, you can play back audio files on these through the product.

CAUTION

- Do not leave the USB device unattended in the vehicle.
- Never hold these devices in your hand to operate while driving, as this is dangerous.
- Do not use hard discs, card readers, or memory readers, as damage may occur to these or to the data contained therein. If these are erroneously connected, then turn the ignition switch to the “LOCK” position, then remove.
- Because of the risk of data loss, it is recommended that files be backed up.
- No guarantee is made as regards damage to the USB device, nor regarding loss or damage to data contained therein.
- Depending on how the devices are handled, audio files being damaged or lost, therefore it is recommended that data be backed up.

NOTE

- Digital audio players that support the mass storage class specifications can be connected.

NOTE

- For details regarding the types of USB devices that can be connected and the types of files that can be played back in vehicles with a Bluetooth® 2.0 interface, refer to “Types of connectable devices and supported file specifications” on page 5-153.
- Regarding how to connect USB devices, refer to “How to connect a USB memory device” on page 5-151.
- When connecting a USB device, use a connection cable. Failure to use a connection cable when connecting may place undue load on, or damage the USB connector.
- Set up the device in order that no unsafe actions, such as plugging in the connection cable are taken while driving.
- When inserting and removing the USB device, for safety’s sake first stop the vehicle.
- Do not insert other than audio devices into the USB port. Damage to the device or equipment may result.
- Depending on the status of the USB device, it may take some time until the device is recognized, or playback starts.
- Depending on USB devices, buttons on the product will not operate while the USB device is connected.
- USB device specifications and settings may mean that connection is not possible, or result in differences in operation or display.

NOTE

- Depending on audio data in the USB device, track information may not be displayed correctly.
- Depending on the status of the vehicle and device, the iPod/iPhone may not play back after starting the engine.
- Data containing copyright information may not play back.
- This product can play back MP3, WMA, and AAC format audio files.
- Depending on the type of USB device, usage may not be possible, or functions that can be used may be restricted.
- The recommended file system for USB memory is FAT32.
- The maximum supported capacity for USB memory is 32GB.
- Operate the USB device containing recorded audio files while connected to this product.

Play Back of Audio Files on a USB Device

Press the MEDIA key to set USB as the source.

The selected source is indicated on the display.

Listen to Audio Files on a USB Device**Select the Track (File)**

Press the ◀◀ key or ▶▶ key to select the track.

This enables selection of the next or previous track.

Fast Forward or Rewind

Hold down the 3 ◀◀ key or the 4 ▶▶ key.

Fast forward/rewind is possible.

Switch Playback Mode

Repeat playback, random playback, and scan playback are possible.

Repeat Playback (RPT)

Press the 1RPT key.

Repeat playback of the track currently being played.

NOTE

- Pressing again will cancel.

Listen to Audio Files on a USB Device

NOTE

- Selecting a file will cancel this. However, it will not be cancelled in vehicles with a Bluetooth® 2.0 interface.

Folder Repeat Playback

Hold down the 1RPT key.

7

Repeat playback of the tracks within the folder currently being played.

NOTE

- Pressing again will cancel.
- Selecting a folder will cancel this.
- Cycling up/down through files will cancel this.
- Even if the file is selected, folder repeat playback will not be cancelled.

Folder Random Playback (RDM)

Press the 2RDM key.

Play tracks in the folder currently being played in a random order.

NOTE

- Pressing again will cancel.
- Selecting a folder will cancel this.

7-32 Comfort controls

NOTE

- Cycling up/down through files will cancel this.
- Even if the file is selected, folder random playback will not be cancelled.

All Folder Random Playback

Hold down the 2RDM key.

Play the tracks in all folders in a random order.

NOTE

- Pressing again will cancel.
- Selecting a folder will cancel this.
- Cycling up/down through files will cancel this.
- Even if the file is selected, all folder random playback will not be cancelled.

Scan Playback (SCAN)

Press the SCAN key.

Play the first 10 seconds of each of the tracks on the whole USB device in order.

NOTE

- Press this button again during playback if you wish to hear that track, and that track will play normally.

Folder Scan Playback

Hold down the SCAN key.



Play the first 10 seconds of the first track in each folder on the USB device in order.

NOTE



- Press this button again during playback if you wish to hear that track, and that track will play normally.

Search Tracks

Search folders and files, and select a track.

1. Turn the /SEL key to select the folder.
2. Press the /SEL key.

Files within the selected folder are displayed.

3. Turn the /SEL key to select the file.
4. Press the /SEL key.

To play iPod/USB memory device tracks via voice operation (vehicles with Bluetooth® 2.0 interface)

This plays the selected file (track).

NOTE

- While the folder is selected, press the 6 ➡ key to cancel track search mode.
- If there is no operation for 10 seconds after selecting the folder, then track search mode will be cancelled.
- Select the folder, and hold down the ▶/SEL key to start playback from the first track in that folder.
- While the file is selected, press the 6 ➡ key to return to the previous operation.
- While the file is selected, hold down the 6 ➡ key to cancel track search mode.
- If there is no operation for five seconds after selecting the file, that file is played back.
- Operations such as selecting a track will cancel track search mode.

To play iPod/USB memory device tracks via voice operation (vehicles with Bluetooth® 2.0 interface)

N00772001054

When connected to the USB input terminal, desired tracks on the iPod/USB memory device which is connected to the USB input

terminal can be selected and played via voice operation.

For information concerning the voice recognition function or speaker registration function, refer to “Bluetooth® 2.0 interface” on page 5-129.

The following explains how to prepare for voice operation and play the tracks.

Preparation for voice operation

N00772101055

To use the voice operation, press the SPEECH button (A) first.

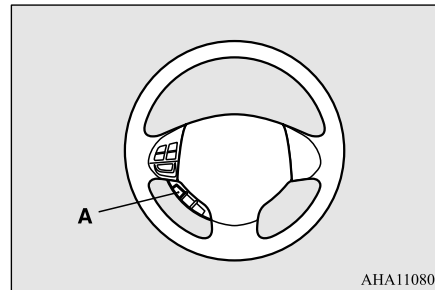

AHA110800

To search by artist name

N00772201030

1. Say “Play” on the main menu.

NOTE

- The Bluetooth® 2.0 interface starts recognizing the connected device. If the connected device cannot be recognized or a connection error occurs, the Bluetooth® 2.0 interface starts an appropriate voice guide. Follow the voice guide.

2. After the voice guide says “Would you like to play by Artist, Album, Playlist or Genre?,” say “Artist”.

NOTE

- If you say “Artist <name>,” you can skip step 3.

3. After the voice guide says “What Artist would you like to play?,” say the artist name.
4. If there is only one match, the system proceeds to step 6.
5. If there are two or more matches, the voice guide will say “More than one match was found, would you like to play <artist name>?” If you say “Yes,” the system proceeds to step 6. If you say “No,” the next matching artist is uttered by the system.

To play iPod/USB memory device tracks via voice operation (vehicles with Bluetooth® 2.0 interface)

NOTE

- If you say “No” to three or all artist names uttered by the system, the voice guide will say “Artist not found, please try again” and the system returns to step 2.
- Search time is dependant on the number of songs on your connected device. Devices containing a large number of songs may take longer to return search results.

7

6. After the voice guide says “Playing <artist name>,” the system creates a playlist index for the artist.

NOTE

- If the confirmation function is active, the voice guide confirms if the artist name is correct. If the artist name is correct, say “Yes”. If not, say “No”. After the voice guide says “Artist not found, please try again,” the system returns to step 2.

7. The system exits the voice recognition mode and starts playback.

To search by album title

N00772301044

1. Say “Play” on the main menu.

NOTE

- The Bluetooth® 2.0 interface starts recognizing the connected device. If the connected device cannot be recognized or a connection error occurs, the Bluetooth® 2.0 interface starts an appropriate voice guide. Follow the voice guide.

2. After the voice guide says “Would you like to play by Artist, Album, Playlist or Genre?,” say “Album”.

NOTE

- If you say “Album <title>,” you can skip step 3.

3. After the voice guide says “What Album would you like to play?” say the album title.

4. If there is only one match, the system proceeds to step 6.

5. If there are two or more matches, the voice guide will say “More than one match was found, would you like to play <album title>?” If you say “Yes,” the system proceeds to step 6.

If you say “No,” the next matching album is uttered by the system.

NOTE

- If you say “No” to three or all album titles uttered by the system, the voice guide will say “Album not found, please try again” and the system returns to step 2.

6. After the voice guide says “Playing <album title>,” the system creates a playlist index for the album title.

NOTE

- If the confirmation function is active, the voice guide confirms if the album title is correct. If the album title is correct, say “Yes”. If not, say “No”. After the voice guide says “Album not found, please try again,” the system returns to step 2.

7. The system exits the voice recognition mode and starts playback.

To search by playlist

N00772401032

1. Say “Play” on the main menu.

To play iPod/USB memory device tracks via voice operation (vehicles with Bluetooth® 2.0 interface)

NOTE

- The Bluetooth® 2.0 interface starts recognizing the connected device.
If the connected device cannot be recognized or a connection error occurs, the Bluetooth® 2.0 interface starts an appropriate voice guide. Follow the voice guide.

2. After the voice guide says “Would you like to play by Artist, Album, Playlist or Genre?,” say “Playlist”.

NOTE

- If you say “Playlist <playlist>,” you can skip step 3.
If the device has no playlist, the voice guide will say “There are no playlists stored on device” and the system returns to step 2.

3. After the voice guide says “What Playlist would you like to play?,” say the playlist name.
4. If there is only one match, the system proceeds to step 6.
5. If there are two or more matches, the voice guide will say “More than one match was found, would you like to play <playlist>?” If you say “Yes,” the system proceeds to step 6.
If you say “No,” the next matching playlist name is uttered by the system.

NOTE

- If you say “No” to three or all playlist names uttered by the system, the voice guide will say “Playlist not found, please try again” and the system returns to step 2.

6. After the voice guide says “Playing <playlist>,” the system creates an index for the playlist.

NOTE

- If the confirmation function is active, the voice guide confirms if the playlist name is correct. If the playlist name is correct, say “Yes”. If not, say “No”. After the voice guide says “Playlist not found, please try again,” the system returns to step 2. Refer to “Confirmation function setting” on page 5-133.

7. The system exits the voice recognition mode and starts playback.

To search by genre

N00772501046

1. Say “Play” on the main menu.

NOTE

- The Bluetooth® 2.0 interface starts recognizing the connected device.
If the connected device cannot be recognized or a connection error occurs, the Bluetooth® 2.0 interface starts an appropriate voice guide. Follow the voice guide.

2. After the voice guide says “Would you like to play by Artist, Album, Playlist or Genre?,” say “Genre”.

NOTE

- If you say “Genre <type>,” you can skip step 3.

3. After the voice guide says “What Genre would you like to play?,” say the music type.
4. If there is only one match, the system proceeds to step 6.
5. If there are two or more matches, the voice guide will say “More than one match was found, would you like to play <genre>?” If you say “Yes,” the system proceeds to step 6.
If you say “No,” the next matching genre is uttered by the system.

7

Listen to Bluetooth Audio (if so equipped)

NOTE

- If you say “No” to three or all genres uttered by the system, the voice guide will say “Genre not found, please try again” and the system returns to step 2.

6. After the voice guide says “Playing <genre>,” the system creates an index for the genre.

7

NOTE

- If the confirmation function is active, the voice guide confirms if the genre is correct. If the genre is correct, say “Yes”. If not, say “No”. After the voice guide says “Genre not found, please try again,” the system returns to step 2. Refer to “Confirmation function setting” on page 5-133.

7. The system exits the voice recognition mode and starts playback.

Listen to Bluetooth Audio (if so equipped)

N00717500020

This product can play back tracks on commercially-available Bluetooth-capable audio devices.

7-36 Comfort controls

CAUTION

- Never hold these devices in your hand to operate while driving, as this is dangerous.
- Do not leave the Bluetooth audio device unattended in the vehicle.
- Depending on how the devices are handled, audio files being damaged or lost, therefore it is recommended that data be backed up.

NOTE

- Depending on the type of Bluetooth-capable audio devices, usage may not be possible, or functions that can be used may be restricted.
- Confirm together with the user manuals for the commercially-available Bluetooth-capable audio devices.
- Depending on the type of Bluetooth-capable audio devices, volume levels may differ. There is the danger of loud volumes, so prior to use, it is recommended that you turn the volume down.
→ “Adjust Volume” (P.7-20)
- Depending on the status of the Bluetooth audio device, it may take some time until the device is recognized, or playback starts.
- Bluetooth audio device specifications and settings may mean that connection is not possible, or result in differences in operation or display.
- Depending on audio data in the Bluetooth audio device, track information may not be displayed correctly.

NOTE

- Depending on the status of the vehicle and device, the iPod/iPhone may not play back after starting the engine.

Connect a Bluetooth-capable Audio Device

Regarding how to connect your Bluetooth device, refer to “Connecting the Bluetooth® 2.0 interface and Bluetooth device” on page 5-135.

Operation methods below describe situations once connection has been completed.

NOTE

- If the iPod/iPhone is connected via Bluetooth as a Bluetooth-capable audio device, then do not connect the iPod/iPhone using an iPod cable. Connection using both methods will result in erroneous operation.

Play Bluetooth Audio



1. Press the MEDIA key to set Bluetooth Audio as the source.

The selected source is indicated on the display.



Listen to Bluetooth Audio (if so equipped)

2. Press the 5  key. Bluetooth Audio playback starts.

NOTE

- Hold down the 5  key to pause.
- Press the 6  key to stop.

Select the Track (File)

Press the 1  key or  key to select the track.

This enables selection of the next or previous track.

Fast Forward or Rewind

Hold down the 3  key or the 4  key.

Fast forward/rewind is possible.

Switch Playback Mode

Repeat playback, random playback, and scan playback are possible.

Repeat Playback (RPT)

Press the 1RPT key.

Repeat playback of the track currently being played.

NOTE

- Each time the 1RPT key is pressed, this switches in the order Repeat OFF, 1 track repeat, All track repeat, and Repeat OFF.

Random Playback (RDM)

Press the 2RDM key.

Play the tracks in the Bluetooth Audio device in a random order.

NOTE

- Pressing again will cancel.

Scan Playback (SCAN)

Press the SCAN key.

Play the first 10 seconds of each of the tracks on the whole Bluetooth Audio device in order.

NOTE

- Press this button again during playback if you wish to hear that track, and that track will play normally.

Display Indicator

Display Indicator

N0071770022

This explains content of the display indicator.

7



AA1008779

Change the Display Mode

N0071780078

You can change the content of the display indicator.

Press the INFO key to switch the display content.

Each time the INFO key is pressed, the display content changes.

CAUTION

- The operation of changing display contents may impede safe driving, therefore check safety before operation.

NOTE

- Up to 11 characters may be displayed at one time. To display 12 or more characters, press the PAGE key, and subsequent characters will be displayed.

During FM Reception

This switches in the order “Frequency”, “Station name”, and “Radio text”.

NOTE

- Radio text has a maximum display of 64 characters.
- If there is no text information to display, then “NO MESSAGE” is displayed.

Audio Quality and Volume Balance Adjustment

During Satellite Radio Reception (if so equipped)

This switches in the order “Channel name”, “Category name”, “Artist name”, “Track name”, and “Composer name”.

NOTE

- The channel and category have a maximum display of 8 characters. The other items have a maximum display of 36 characters.

During CD-DA playback

This switches in the order “Disc title”, “Track title”, and “Operating status”.

NOTE

- If there is no text information to display, then “NO TITLE” is displayed.

During MP3/WMA/AAC Playback

This switches in the order “Folder title”, “File title”, and “Operating status”.

NOTE

- If there is no text information to display, then “NO TITLE” is displayed.

Display the ID3tag

Hold down the INFO key.

This switches the ID3tag display. Each time INFO key is pressed, this switches in the order “Album name”, “Track name”, “Artist name”, “Genre name”*, and “Operating status”.

*:Displayed when playing back audio files on a USB device (vehicles with a Bluetooth® 2.0 interface).

NOTE

- During display of the ID3tag, hold down the INFO key to switch to the folder title display.
- The genre name display may not be possible.

During iPod Playback

N00718200024

This switches in the order “Albums”, “Track name”, “Artist name”, “Genre name”, and “Operating status”.

NOTE

- If there is no text information to display, then “NO TITLE” is displayed.
- Displayed genre name in equipment by type (vehicles with a Bluetooth® 2.0 interface).
- The genre name display may not be possible.

During Bluetooth® 2.0 Audio Playback (if so equipped)

N00718300025

7

Operating details are the same as in “During iPod Playback” (P.7-39).

Audio Quality and Volume Balance Adjustment

N00718400055

Change audio quality settings.

Adjust Audio Quality and Volume Balance

1. Press the **▶/SEL** key to select settings items.

Each time the **▶/SEL** key is pressed, this switches in the order BASS, TREBLE, FADER, BALANCE, SCV (speed compensated volume), and Cancel.

Comfort controls 7-39

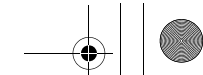

System Settings

2. Turn the **▶**/SEL key to adjust.

Adjustment items	Turn counter-clockwise	Turn clockwise
BASS	-6 to 0 (Low low-pass volume)	0 to +6 (High low-pass volume)
TREBLE	-6 to 0 (Low high-pass volume)	0 to +6 (High high-pass volume)
FADER	CENTER to REAR 11 (emphasize REAR)	FRONT 11 to CENTER (emphasize FRONT)
BALANCE	LEFT 11 to CENTER (emphasize LEFT)	CENTER to RIGHT 11 (emphasize RIGHT)
SCV	OFF, LOW (SCV effect is OFF/low)	MID, HIGH (SCV effect is middle/high)

7

2. Press the **▶**/SEL key to select settings items.

Each time the **▶**/SEL key is pressed, this switches in the order Satellite radio settings*¹, Gracenote DB*², PHONE settings, Adjust time, and Cancel.

3. Turn the **▶**/SEL key to set.

4. Press the **▶**/SEL key to determine.

This completes settings, and displays the next settings item.

*¹. Displayed when a satellite tuner is connected.

*². Displayed when playing back audio files (vehicles with a Bluetooth[®] 2.0 interface).

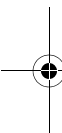

System Settings

N00718500098

Change system settings such as product time.

1. Press the MENU key.

7-40 Comfort controls

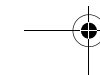
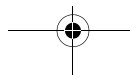



Satellite Radio Settings (if so equipped)

Change each satellite radio setting.

Settings name	Settings item	Settings value	Settings content
SIRIUS ID	—	—	This displays the SIRIUS ID.
SKIP SETTING	SKIP SETTING SELECT CH* ¹	ON	SKIP can be set for each channel. Channels for which SKIP is set are excluded from the search during up/down channel selecting and scanning. They can be received when selecting channels using the preset keys or searching for a station.
		OFF	
	SKIP SETTING ALL RESET	—	When “YES” is selected, the SKIP settings for all channels are turned off.
LOCK SETTING	LOCK SETTING SELECT CH* ²	ON	LOCK can be set for each channel. Channels for which LOCK is set are excluded from the search during up/down channel selecting and scanning. If a channel for which LOCK is set is selected when selecting channels using the preset keys or searching for a station, “CH LCKED” is displayed within about 2 seconds after the channel text is displayed. The sound is muted.
		OFF	
	LOCK SETTING ALL RESET	—	When “YES” is selected and the CODE for settings is input, the LOCK settings for all channels are turned off.
	LOCK SETTING EDIT CODE	—	The CODE required for the LOCK settings is changed. (The factory setting is “1111”.) If the input code is incorrect, “LOCK SETTING WRG LC” is displayed.

7

*¹: Each time the /SET key is pressed, this switches in the order Settings channel select, Change SKIP settings, and Complete settings.
To return to “each channel SKIP setting”, press the 6  key.

System Settings

*2: Once the CODE (passcode) of your choice is entered, each time the **▶/SEL** key is pressed, this switches in the order Settings channel select, Change LOCK settings, and Complete settings.

To return to “each channel LOCK setting”, press the **6** **➡** key. Input the CODE from the 1 RPT key to the **6** **➡** key.

Time Setting

Set the time manually.

7

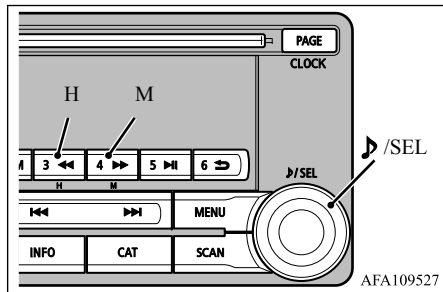

1. Select “YES” at the “Adjust time” screen, and press the **▶/SEL** key.
2. Press the various keys to adjust.

- H - “Hour” setting
Press this key to fast-forward the “hours”.
- M - “Minutes” setting
Press this key to fast-forward the “minutes”.

3. Press the **▶/SEL** key.

7-42 Comfort controls

This completes the adjustment.

NOTE

- In order to finish adjusting the time, hold down the **▶/SEL** key until the seconds are reset to “00”.
- The time can also be set using another procedure. Refer to “CLOCK” on page 7-46.

PHONE Settings

Change the mobile phone voice cut-in settings and the Bluetooth® 2.0 interface language.

Depending on the vehicle, PHONE settings may not be possible.

NOTE

- Cancel functions such as the mobile phone “dial lock”, and connect while on the standby screen.
- While connected, mobile phone (receiving calls, etc.) operations may not function correctly.

NOTE

- Depending on the distance between the product and the mobile phone, the conditions within the vehicle, and types of screening, connection may not be possible. In these cases, situate the mobile phone as close as possible to the product.
- Even though a Bluetooth-capable mobile phone, characteristics and specifications may mean that correct operation may not be possible.
- For safety’s sake, do not operate the mobile phone while driving. When operating the mobile phone, first stop the vehicle in a safe location.
- Even though a Bluetooth-capable mobile phone, phone specifications and settings may result in differences in display, or prevent correct operation.
- Some models may not be confirmed as connected, or may not connect.

Supported profiles

Hands-free	HFP(v1.5)
Phonebook transfer	OPP(v1.1), PBAP(v1.0)

Vehicles without a Bluetooth® 2.0 Interface

A hands-free kit (available separately) is required.

("Set value" bold typeface indicates factory default settings.)

Settings value	Settings content
PHONE OFF	Do not use mobile phone voice cut-in.
PHONE MUTE	During mobile phone voice cut-in, mute the audio.
PHONE ATT	During mobile phone voice cut-in, output audio from all speakers.
PHONE IN-L	During mobile phone voice cut-in, output sound from the left front speaker.
PHONE IN-R	During mobile phone voice cut-in, output sound from the right front speaker.
PHONE IN-LR	During mobile phone voice cut-in, output sound from the left and right front speakers.

Vehicles with a Bluetooth® 2.0 Interface

("Set value" bold typeface indicates factory default settings.)

Settings name	Settings value	Settings content
HFM voice language settings	ENG-LISH	Change the hands free module voice language.
	FRENCH	
	SPANISH	
	JAPANESE	

Gracenote DB (Vehicles with a Bluetooth® 2.0 interface)

The version number can be confirmed.

1. Select "Gracenote DB" and press the **▶/SEL** key.
2. Turn the **▶/SEL** key and select "DB Version".
3. Press the **▶/SEL** key.
The DB Version is displayed.

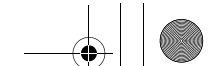

Troubleshooting

Troubleshooting

N00718600031

Please check these items if a message appears on the display, or if you think something is not working properly.

If This Message Appears...

A message is displayed on this product according to the situation.

7

Mode	Message	Cause	Response
CD	CHECK DISC	The disc is inserted upside down.	Insert with the label side up.
		The disc has condensation on it.	Wait a while before inserting again.
	DISC ERROR	The disc is damaged.	Clean the read surface of the disc.
		The disc is dirty.	
	INTERNAL E	The drive has malfunctioned for some reason.	Check that there is no problem with the disc, and insert the disc again. If the problem persists, consult an authorized Mitsubishi Motors dealer or a repair facility of your choice.
HEAT ERROR	The temperature inside the product is high.	Remove the disc, and wait for the internal temperature to return to normal.	

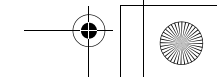
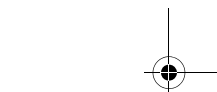
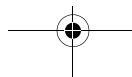
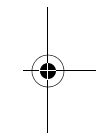
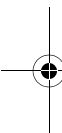

Troubleshooting

Mode	Message	Cause	Response
USB	FILE ERROR	Files that cannot be played are selected.	Select files that can be played. → “Audio Files (MP3/WMA/AAC)” (P.7-15)
	USB BUS PWR	There is high or low electrical current or voltage.	Turn the power OFF and wait a short while. If the problem persists, consult an authorized Mitsubishi Motors dealer or a repair facility of your choice.
	LSI ERROR	There is an internal malfunction for some reason.	
	UNSUPPORTED FORMAT	Unsupported audio files have been played.	Confirm audio files that can be played. → “Audio Files (MP3/WMA/AAC)” (P.7-15)
	UNSUPPORTED DEVICE	An unsupported USB device has been connected.	Please connect a USB memory device.
iPod	NO SONG	An iPod/iPhone not containing any tracks has been connected.	Connect an iPod/iPhone containing tracks.
	VER ERROR	This iPod/iPhone software version is not supported.	Please change to a supported software version.
Other	ERROR DC	An abnormal direct voltage has been sent to the speakers.	Turn the power OFF and wait a short while. If the problem persists, consult an authorized Mitsubishi Motors dealer or a repair facility of your choice.

7

If You Think Something Is Not Working Properly...

Here is a list of symptoms, causes and responses if you think something is not working properly.

Symptoms	Cause	Response
There is no sound or quiet sound.	The volume is turned to its minimum.	Adjust the volume. → “Adjust Volume” (P.7-20)
	The balance or fader is turned to one side.	Adjust the balance or fader. → “Adjust Audio Quality and Volume Balance” (P.7-39)

Antenna

Symptoms	Cause	Response
The disc cannot be inserted.	A disc is already in the product.	Eject the disc. → “Insert/Eject Discs” (P.7-20)
	There is no disc in the product, but the product says it is loading.	Press the eject button once. → “Insert/Eject Discs” (P.7-20)
The disc cannot be played.	The disc is inserted upside down.	Insert with the label side up.
	The disc has condensation on it.	Wait a while before inserting.
	The disc is dirty.	Clean the read surface of the disc.
The sound skips in the same place.	The disc is damaged or dirty.	Check the disc.
There is no sound, even if the disc is inserted.	Damage to or dirt on the disc means that its data cannot be read.	Check the disc. Additionally, if using CD-R/RW discs, their characteristics may render them unable to be played.

7

Antenna

N00734200468

To remove

Turn the pole (A) counterclockwise.

To install

Screw the pole (A) clockwise into the base (B) until it is securely retained.

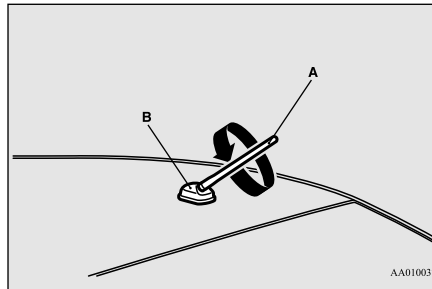

AA0100373

NOTE

- Be sure to remove the roof antenna in the following cases:
 - When using an automatic car wash

NOTE

- When covering your vehicle with a car cover
- When driving into a structure that has a low ceiling

Clock (if so equipped)

N00755001189

The time is displayed when the ignition switch is in ON or ACC.

NOTE

- Reset the time after the battery terminals are disconnected and reconnected.

Time Setting

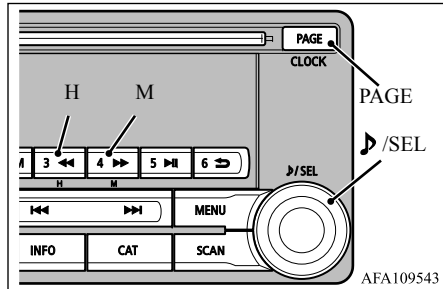

1. Press and hold the PAGE key until the clock display flashes.
2. Press the various keys to adjust.
 - H - "Hour" setting
Press this key to fast-forward the "hours".
 - M - "Minutes" setting
Press this key to fast-forward the "minutes".
3. Press the PAGE key to finish adjusting the time. When the adjustment is complete, the clock display stops flashing.

NOTE

- If the PAGE key is pressed and held when the time adjustment is finished, the seconds will be reset to "00".

NOTE

- The time can also be set using another procedure. Refer to "System Settings" on page 7-40.

General information about your radio

N00733901481

Your vehicle's radio receives both AM and FM stations.

The quality of your reception is affected by distance, obstacles, and signal interference.

This radio complies with Part 15 of Federal Communications Commission (FCC) Rules (for vehicles sold in U.S.A.). Operation is subject to the following conditions:

- The device may not cause harmful interference.
- This device must accept any interference received, including interference that may cause undesirable operation.

CAUTION

- Changes or modifications not expressly approved by the party meeting the above conditions could void the user's authority to operate the equipment.

General information about your radio

Signal transmission

FM signals do not follow the earth surface nor are they reflected by the upper atmosphere. For this reason, FM broadcasts cannot be received over long distances. AM signals follow the earth's surface and are reflected by the upper atmosphere. For this reason, AM broadcasts can be received over longer distances.

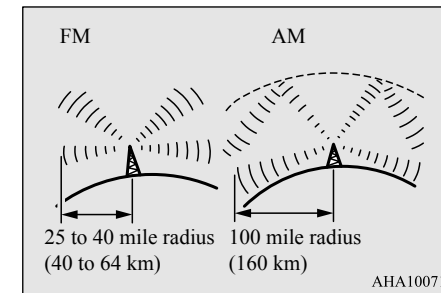

Weak reception (fading)

Because of the limited range of FM signals and the way FM waves transmit, you may experience weak or fading FM reception. When the broadcast is blocked by mountains or similar obstructions, reception can be disturbed.

General information about your radio

Reflection

The reason why one can hear FM but not AM in parking garages, under bridges etc., is that FM signals, unlike AM signals, are reflected by solid objects such as buildings, etc.

Because FM signals are easily reflected by buildings, this can also cause reception disturbances.

The direct signal from the broadcast station reaches the antenna slightly before the reflected signal. This time difference may cause some reception disturbance or flutter.

This problem occurs primarily in urban areas.

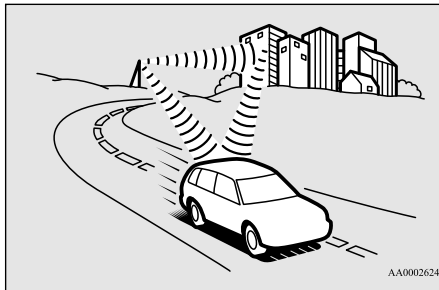

7

Cross modulation

If one listens to a weak station and is in the vicinity of another strong station, both stations might be received simultaneously.

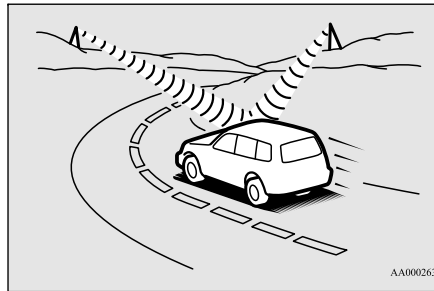

FM stereo reception

Stereo reception requires a high quality broadcast signal. This means that types of disturbances mentioned previously become more marked and the reception range is somewhat diminished during stereo reception.

Causes of disturbances

FM reception is affected by the electrical systems of vehicles in the vicinity, especially those without an electronic noise suppression device. The disturbance is even greater if the station is weak or poorly tuned.

FM reception is not as sensitive to electrical disturbances as AM. AM reception is sensitive to electrical disturbances such as power lines, lightning and other types of similar electrical phenomena.

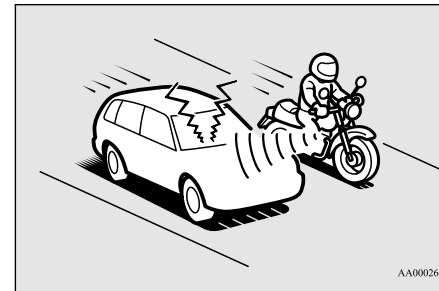

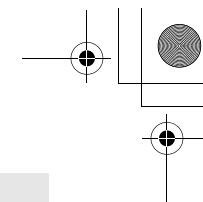

For emergencies

If the vehicle breaks down	8-2
Jump-starting the engine	8-2
Engine overheating	8-4
Tools and jack	8-5
How to change a tire	8-6
Towing	8-11
Operation under adverse driving conditions	8-12
Fuel Pump Shut-off System	8-14

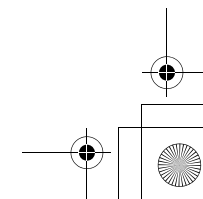
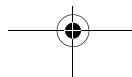
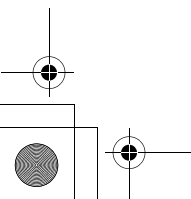
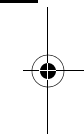
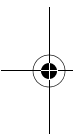

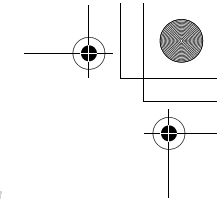

If the vehicle breaks down

If the vehicle breaks down

N00836300204

If your vehicle breaks down on the road, move to the shoulder and turn on the hazard warning flashers. If there is no shoulder, or the shoulder is not safe, drive in the right lane slowly, with the hazard lights flashing, until you come to a safe stopping place. Keep the flashers flashing.

If the engine stops/fails

8

If the engine stops, there will be no power assist to the steering and brakes, making these difficult to use.

- The brake booster will not work, so the brakes will not grip well. The brake pedal will be harder to press than usual.
- Since there is no power steering assist, the steering wheel will be hard to turn.

When the engine fails at the intersection

Get help from your passengers, bystanders, etc. to push the vehicle and move it to a safe zone.

8-2 For emergencies

Jump-starting the engine

N00836401794

If the engine cannot be started because the battery is weak or dead, you can start it with the battery from another vehicle using jumper cables.

WARNING

- When using jumper cables to start a vehicle, follow the procedures and be very cautious.

CAUTION

- Do not try to start your vehicle by pushing or towing. Vehicles equipped with continuously variable transmission (CVT) cannot be started this way. Pushing or towing a vehicle that has a manual transaxle may overheat and damage the catalytic converter. Also, there is more risk of an accident when a vehicle is being pushed or towed.

1. Take off any metal jewelry such as watch bands or bracelets that might make an accidental electrical contact.
2. Position the vehicles close enough together so that the jumper cables can reach, but be sure the vehicles aren't touching each other.

CAUTION

- Check the other vehicle. It must have a 12-volt battery. If the other system isn't 12-volt, both systems can be damaged.

3. You could be injured if the vehicles move. Set the parking brake firmly on each vehicle. Put an automatic transaxle, CVT in "P" (PARK) or a manual transaxle in "N" (Neutral). Turn the ignition switch to the "LOCK" position.

WARNING

- Turn the ignition switch to the "LOCK" position on both vehicles. Make sure that the cables or your clothes cannot be caught by the fan or drive belt. Personal injury could result.

NOTE

- Turn off all lights, heater, and other electrical loads. This will avoid sparks and help save both batteries.

4. Make sure your battery electrolyte is at the proper level. (Refer to "Checking battery electrolyte level" on page 9-11.)

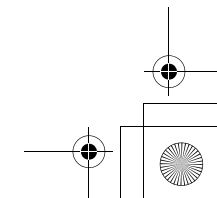
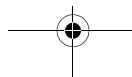

Jump-starting the engine

⚠ WARNING

- If the electrolyte fluid is not visible, or looks frozen, **DO NOT ATTEMPT JUMP STARTING!!**
The battery might split open or explode if the temperature is below the freezing point or if it is not filled to the proper level.

5. Connect one end of one jumper cable to the positive (+) terminal of the discharged battery (A), and the other end to the positive (+) terminal of the booster battery (B).

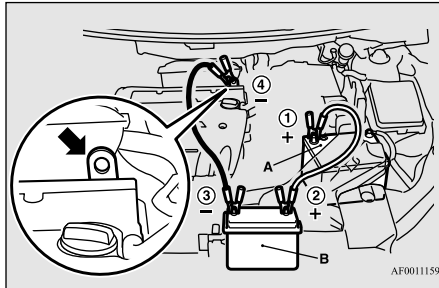

📖 NOTE

- Open the terminal cover before connecting the jumper cable to the positive terminal of the battery.
(Refer to “Disconnection and connection” on page 9-12.)

📖 NOTE

- Use the proper cables suitable for the battery size.
Otherwise heat damage to the cables could result.
- Check the jumper cables for damage and corrosion before use.

6. Connect one end of the other jumper cable to the negative (-) terminal of the booster battery (B), and the other end to the engine block of the vehicle with the low battery (A) at the point farthest from the battery.

⚠ WARNING

- Be sure to follow the proper order when connecting the batteries, of:
①→②→③→④.
- Make sure that the connection ④ is made to the engine properly. If the connection is directly made to the negative side of the battery, the flammable gases from inside the battery might catch fire and explode, causing personal injury.
- When connecting the jumper cable, do not connect the positive (+) cable to the negative (-) terminal. Otherwise sparks can make the battery explode.

⚠ CAUTION

- Make sure that the jumper cable will not be caught in the cooling fan or other moving parts in the engine compartment.

7. Start the engine in the vehicle providing the boost. Let the engine idle a few minutes, then start the engine in the vehicle with the low battery.

📖 NOTE

- If the engine is started with the air duct removed, the noise produced as air is drawn into the engine will be greater than when the duct is installed.

8

8. After the engine is started, disconnect the cables in the reverse order from the way you connected them.

⚠ WARNING

- Charging your battery while it is still in your vehicle might cause the battery to catch fire and explode. If you have to charge it while in the vehicle, disconnect the negative terminal.
- Keep sparks, cigarettes and flames away from the battery because the battery may explode.
- Keep your work area well vented when charging or using the battery in an enclosed space.

Engine overheating

WARNING

- Remove all the caps before charging the battery.
- Electrolyte (battery acid) is corrosive diluted sulphuric acid. If electrolyte comes in contact with your hands, eyes, clothes, or the painted surface of your vehicle, thoroughly flush with water. If electrolyte gets in your eyes, flush them immediately and thoroughly with water, and get prompt medical attention.
- Always wear protective clothing and goggles when working near the battery.
- Keep the battery out of the reach of children.

8

As your vehicle has anti-lock brakes

If you drive your vehicle with a low battery charge, after the engine has been started by using jumper cables, the engine may misfire. This can cause the anti-lock braking system warning light to blink on and off. This is only due to the low battery voltage. It is not a problem with the brake system. If this happens, fully charge the battery and ensure the charging system is operating properly.

8-4 For emergencies

Engine overheating

N00836500323

When the engine is overheating, the information screen in the multi-information display will be interrupted and the engine coolant temperature warning display will appear.

Also  will blink. If this happens:

1. Stop the vehicle in a safe place. Turn on the hazard warning flashers.
2. With the engine still running, carefully raise the engine hood to vent the engine compartment.
3. Check that the cooling fan is running. If the fan is not turning, stop the engine immediately and contact an authorized Mitsubishi Motors dealer or a repair facility of your choice for assistance.

WARNING

- To avoid personal injury, keep hands, hair, jewelry and clothes away from the cooling fan. The cooling fan can start at any time.

4. If you see steam or spray coming from under the hood, turn off the engine.

5. If you do not see steam or spray coming from under the hood, leave the engine on until the bar graph for the engine coolant temperature warning display on the multi-information display goes down. When it is in the middle of the normal zone, you can start driving again. If the bar graph stays in the red zone, turn off the engine.

WARNING

- Before raising the engine hood, check to see if there is steam or spray coming from under the hood. Steam or spray coming from an overheated engine could seriously scald you.
Do not open the hood until there is no steam or spray.

6. When you do not see any more steam or spray, open the hood. Look for obvious leaks, such as a split radiator hose. Be careful as components will be hot. Any leak source must be repaired.
7. If there is no obvious leak source, check the coolant level in the reserve tank. If there is none, or if it is too low, slowly add coolant.
8. If the reserve tank needs coolant, you will probably also need to add coolant to the radiator. Do not loosen or remove the radiator cap until the engine has cooled down.

Tools and jack

⚠ WARNING

● Removing the radiator cap could scald you with escaping hot water or steam. When checking the radiator level, cover the cap with a cloth before trying to remove it. Turn it slowly counterclockwise, without pressing down, to the first notch. The pressure in the system will then be let out. When the pressure is COMPLETELY LET OUT, press down and keep turning the cap counterclockwise until it will come off.

9. Start the engine, and slowly add coolant, up to the bottom of the filler neck. Use plain water if you have to (and replace it with the right coolant as soon as possible).
10. Replace the radiator cap and tighten it fully. Check the engine coolant temperature display on the multi-information display. You can start driving again when the bar graph for the engine coolant temperature display returns to the normal zone.
11. Have your vehicle checked by your authorized Mitsubishi Motors dealer or a repair facility of your choice.

Tools and jack

N00836600324

Storage

The tools and jack are stowed in the luggage compartment.

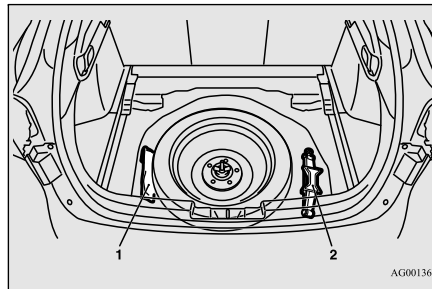

- 1- Tools
- 2- Jack

Tools

N00832600124

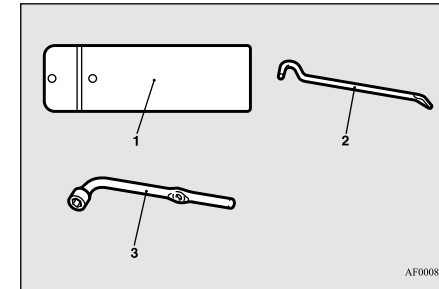

- 1- Tool bag
- 2- Bar
- 3- Wheel nut wrench

8

Jack

N00832700242

Before removing the jack, lift up the board.

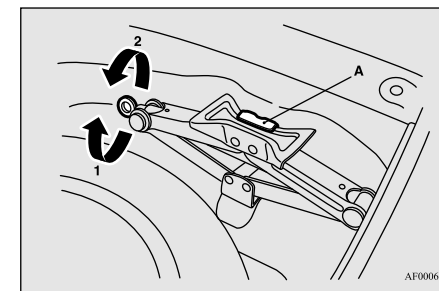

For emergencies 8-5

How to change a tire

To remove

Turn the shaft end (1) so that the jack contracts, then remove it from the storage bracket (A).

To store

Turn the shaft end (2) by hand to expand the jack until it is held firmly in position.

8

How to change a tire

N00836901845

⚠ WARNING

- The jack should not be used for any purpose other than to change a tire.
- Never get under the vehicle or put any portion of your body under the vehicle while it is supported by the jack.

Before changing a tire, first stop your vehicle in a safe, flat location.

1. Park the vehicle on level and stable ground.
2. Set the parking brake firmly.
3. On vehicles equipped with manual trans-axle, turn the ignition switch to the “LOCK” position, and move the gearshift lever to the “R” (Reverse) position.

8-6 For emergencies

On vehicles equipped with continuously variable transmission (CVT), move the selector lever to the “P” (PARK) position, and turn the ignition switch to the “LOCK” position.

4. Turn on the hazard flashers and set up a warning triangle, flashing signal light, etc., at an adequate distance from the vehicle, and have all your passengers leave the vehicle.
5. To prevent the vehicle from rolling when it is raised on the jack, place chocks or blocks (A) at the tire that is diagonally opposite from the tire (B) you are changing.

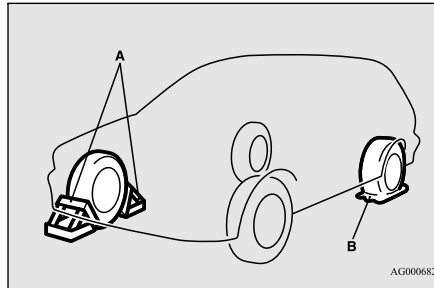

AG0006822

⚠ WARNING

- Be sure to apply chocks or blocks to the correct tire when jacking up the vehicle. If the vehicle moves while jacked up, the jack could slip out of position, leading to an accident.

NOTE

- The chocks shown in the illustration do not come with your vehicle. It is recommended that you purchase chocks or blocks and keep them in the vehicle for use if needed.
- If chocks or blocks are not available, use stones or any other objects that are large enough to hold the wheel in position.

6. Get the jack, bar and wheel nut wrench ready.
Refer to “Tools and jack” on page 8-5.

Spare tire information

N00849600302

Compact spare tire

The compact spare tire is designed to save space in the luggage compartment. Its lighter weight makes it easier to use if a flat tire occurs.

⚠ WARNING

- Tires, including spare tire, degrade over time with age even when they are not being used. It is recommended that tires over 6 years generally be replaced even if damage is not obvious.

How to change a tire

CAUTION

- While the compact spare tire is stowed, the inflation pressure should be checked at least once a month to assure that it remains at the recommended inflation pressure. See the tire and loading information placard attached to the driver's door sill. Refer to "Tire and loading information placard" on page 11-3.
- Driving with an improperly inflated tire can cause an accident. If you have no choice but to drive with an under-inflated tire, keep your speed down and avoid sudden steering or braking, if possible. Inflate the tire to the correct pressure as soon as possible. Refer to "Tire inflation pressures" on page 9-17.
- The compact spare tire should be used only temporarily. While the compact spare tire is being used, the tire pressure monitoring system will not function properly. Have the tire replaced or repaired at an authorized Mitsubishi Motors dealer or a repair facility of your choice as soon as possible.
- You can use the same wheel nuts on the compact spare tire wheel.
- Do not go over 50 mph (80 km/h) when driving with the compact spare tire.
- Avoid fast starting and braking when driving with the compact spare tire.

CAUTION

- Do not drive through automatic car washes and over obstacles that could possibly damage the underside of your vehicle. Because the compact spare tire is smaller than the original tire, there is less clearance between the ground and your vehicle.
- Because the compact spare tire is designed only for your vehicle, do not use it on any other vehicle.
- Do not put the compact spare tire on a different wheel, and do not put standard tires, snow tires, wheel covers or trim rings on the compact spare wheel. Otherwise, you could damage these parts or other parts on your vehicle.
- Do not use snow chain with your compact spare tire. Using a chain could cause damage to your vehicle and loss of the chains.

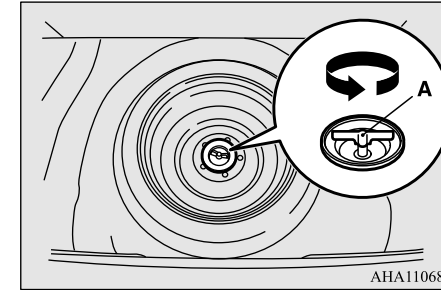

NOTE

- The clamp cannot be used for a normal size tire. Store a normal size tire under the board.
- Put the spare tire under the vehicle body near the jack. This makes it safer if the jack slips out of position.

8

To remove the compact spare tire

N00849701342

1. Lift up the board.
2. To remove the spare tire, remove the installation clamp (A) by turning it counter-clockwise.

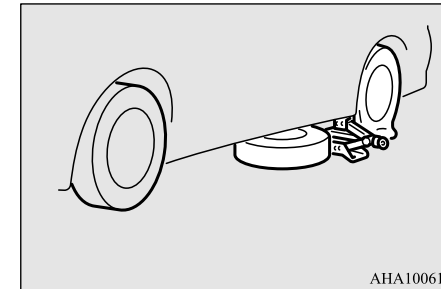

For emergencies 8-7

How to change a tire

To change a tire

N00849801499

1. Loosen the wheel nuts with the wheel nut wrench. Do not remove the wheel nuts yet.

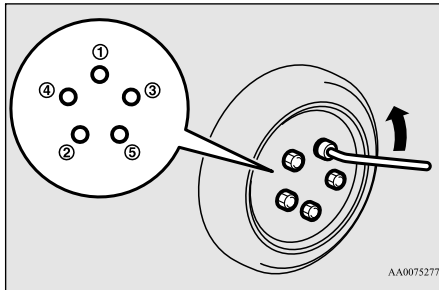

2. Place the jack under one of the jacking points (A) shown in the illustration. Use the jacking point closest to the tire you wish to change.

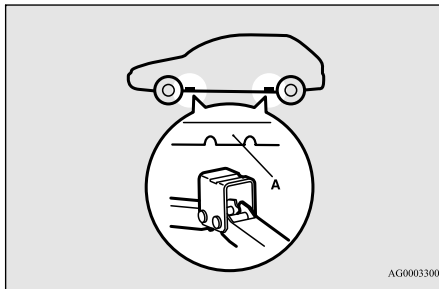

WARNING

- Set the jack only at the positions shown here. If the jack is set at a wrong position, it could dent your vehicle or the jack might fall over and cause personal injury.
- Do not use the jack on a tilted or soft surface. Otherwise, the jack might slip and cause personal injury. Always use the jack on a flat, hard surface. Before setting the jack, make sure there are no sand or pebbles under the jack base.

3. Rotate the jack by hand until the flange portion (B) fits in the groove (C) at the top of the jack.

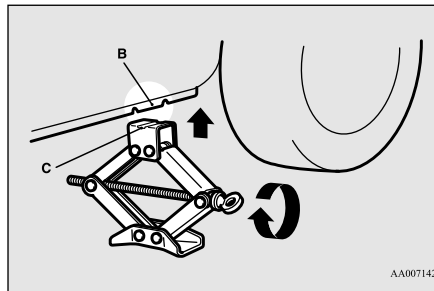

4. Make sure that the flange portion at the jacking point fits in the groove at the top of the jack. Insert the bar (D) into the wheel nut wrench (E). Then put the end of the bar into the shaft's jack end, as shown in the illustration. Slowly rotate the wheel nut wrench until the tire is raised slightly off the ground surface.

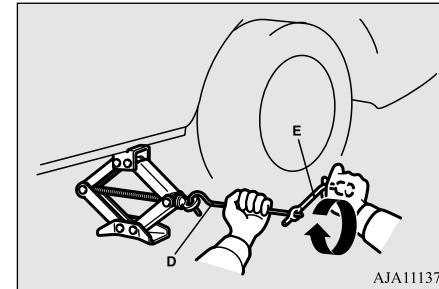

WARNING

- Stop jacking up the vehicle as soon as the tire is raised off the ground. It is dangerous to raise the vehicle any higher.
- Never get under the vehicle or put any portion of your body under the vehicle while it is supported by the jack.
- Do not bump the raised vehicle or leave it sitting on the jack for a long time. Both are very dangerous.
- Do not use a jack except the one that came with your vehicle.

How to change a tire

⚠ WARNING

- The jack should not be used for any purpose other than to change a tire.
- No one should be in your vehicle when using the jack.
- Do not start or run the engine while your vehicle is on the jack.
- Do not turn the raised wheel. The tires that are still on the ground could turn and make your vehicle fall off the jack.

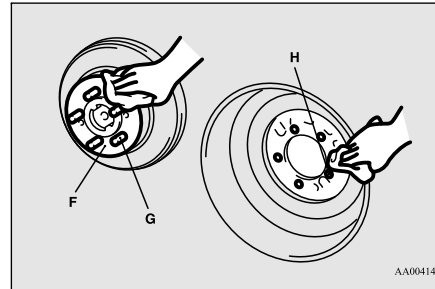

5. Remove the wheel nuts with the wheel nut wrench, then take the wheel off.

⚠ CAUTION

- Handle the wheel carefully when changing the tire, to avoid scratching the wheel surface.

6. Clean out any mud, etc. on the hub surface (F), hub bolts (G) or in the installation holes (H) in the wheel, and then mount the spare tire.

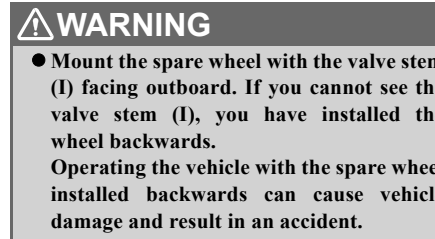

⚠ WARNING

- Mount the spare wheel with the valve stem (I) facing outboard. If you cannot see the valve stem (I), you have installed the wheel backwards. Operating the vehicle with the spare wheel installed backwards can cause vehicle damage and result in an accident.

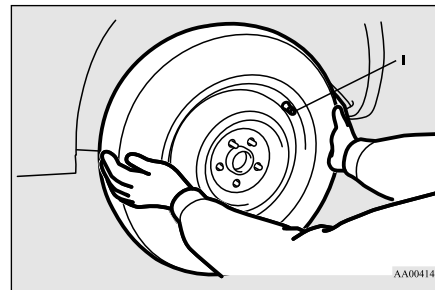

7. • Normal wheels

Temporarily tighten the wheel nuts (flange nuts) until their flange section comes in contact with the wheel and it is no longer loose.

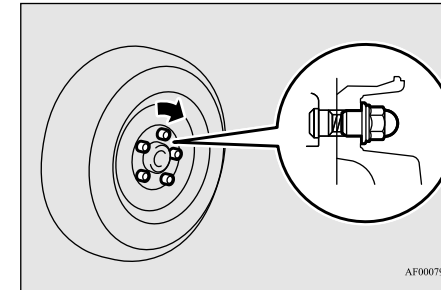

8

- Compact spare wheel
Install the wheel nuts with their tapered ends facing inward, then tighten by hand until the wheel is no longer loose.

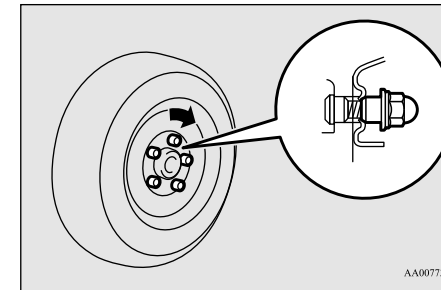

For emergencies 8-9

How to change a tire

⚠ CAUTION

- Never apply oil to either the wheel bolts or the nuts or they will tighten too much.

📖 NOTE

- Flange nuts can be temporarily used on the compact spare wheel, but return them to the original wheel and tire as soon as possible.
- If all four wheels are changed to steel wheels, use tapered nuts.

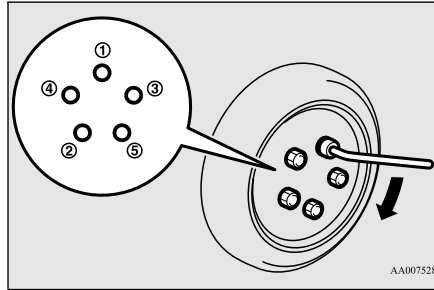

AA0075280

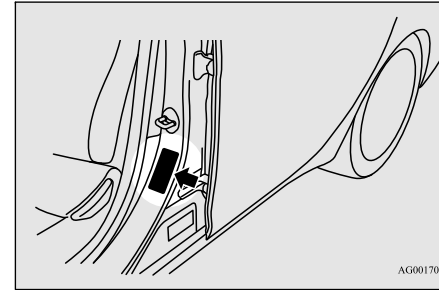

AG0017024

8

8. Lower the vehicle slowly by rotating the wheel nut wrench counterclockwise until the tire touches the ground.

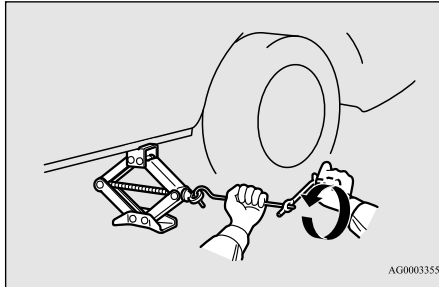

AG0003355

9. Tighten the nuts in the order shown in the illustration until each nut has been tightened to the torque listed here.
65 to 80 ft-lb (88 to 108 N•m)

⚠ CAUTION

- Never use your foot or a pipe extension to apply added force to the wheel nut wrench when tightening the wheel nuts. If you do so, you can over-tighten the wheel nuts and damage the wheel, wheel nuts and hub bolts.

10. Lower the jack all the way and remove it.
11. Check the tire inflation pressure. The recommended tire pressure for your vehicle is listed on the tire and loading information placard attached to the driver's door sill as shown in the illustration. Refer to "Tire inflation pressures" on page 9-17.

⚠ CAUTION

- Driving with an improperly inflated tire can cause an accident. If you have no choice but to drive with an under-inflated tire, keep your speed down and avoid sudden steering or braking, if possible. Inflate the tire to the correct pressure as soon as possible. Refer to "Tire inflation pressures" on page 9-17.
- After changing the tire and driving the vehicle about 620 miles (1,000 km), retighten the wheel nuts to make sure that they have not come loose.
- If the steering wheel vibrates when driving after changing the tire, have the tire checked for balance at your nearest authorized Mitsubishi Motors dealer or a repair facility of your choice.
- Do not mix one type of tire with another or use a different size from the one listed. This would cause early wear and poor handling.

To store the flat tire or spare tire, jack, bar and wheel nut wrench

N00850000159

Reverse the removing procedure when storing the flat tire or spare tire, jack, bar and wheel nut wrench.

Refer to "To remove the compact spare tire" on page 8-7 and "Tools and jack" on page 8-5.

Towing

N00837001944

If your vehicle needs to be towed

If towing is necessary, we recommend you to have it done by a commercial tow truck service.

When towing is required, transport the vehicle using a tow truck.

Incorrect towing equipment could damage your vehicle.

CAUTION

- Do not attempt to be towed by another vehicle with a rope.

NOTE

- Your vehicle cannot tow any other vehicle.

There may be local regulations concerning towing in your area. Obey the regulations of the area where you are driving your vehicle.

Towing

Type A



Type B

Do not tow continuously variable transmission (CVT) vehicles with this style.



Type C



Type D



Type E



AHG100056

Operation under adverse driving conditions

Towing the vehicle by a tow truck

CAUTION

- This vehicle must not be towed by a tow truck using sling lift type equipment (Type A) as illustrated. Using a sling lift will damage the bumper and front end.
- Do not tow continuously variable transmission (CVT) vehicles with the driving wheels on the ground (Type B) as illustrated. If the vehicle is towed like this, the continuously variable transmission (CVT) fluid may not reach all parts of the transmission, thus damaging it.

8

If you tow CVT vehicles, use Type C, D or E equipment.

- If the manual transaxle is malfunctioning or damaged, transport the vehicle with the driving wheels on a carriage (Type C, D or E) as illustrated.
- [For front-wheel drive vehicle equipped with the active stability control (ASC)]
If the vehicle is towed with the ignition switch in the “ON” position and only the front wheels or only the rear wheels raised off the ground, the ASC may operate, resulting in an accident. When towing the vehicle with only the front wheels or only the rear wheels raised, keep the ignition switch in the “LOCK” or “ACC” position.

Towing manual transaxle vehicles with rear wheels off the ground (Type B)

Place the gearshift lever in the “Neutral” position.

Turn the ignition switch to the “ACC” position and secure the steering wheel in a straight-ahead position with a rope or tie-down strap. Never place the ignition switch in the “LOCK” position when towing.

Towing with front wheels off the ground (Type C)

Release the parking brake.

Place the gearshift lever in the “Neutral” position (manual transaxle) or the selector lever in the “N” (NEUTRAL) position (CVT).

WARNING

- To prevent entry of exhaust gas from the towing vehicle, set the selection switch to the recirculation position.

Operation under adverse driving conditions

N00837200705

If your vehicle becomes stuck in sand, mud or snow

If your vehicle becomes stuck in snow, sand, or mud, it can often be moved by a rocking motion. Rock your vehicle back and forth to free it.

Do not rev the engine or spin the wheels. Constant efforts to free a stuck vehicle can cause overheating and transaxle failure. Let the engine idle for a few minutes to cool the transaxle before trying again.

If your vehicle is still stuck after several rocking attempts, call for a commercial tow truck service.

WARNING

- When trying to rock your vehicle out of a stuck position, make sure that there are no people nearby. The rocking motion can make your vehicle suddenly lurch forward or backward, and injure any bystanders.

Operation under adverse driving conditions

On wet roads**⚠ CAUTION**

- Avoid flooded roads. Water is often deeper than it looks, and you could be seriously hurt by driving into flood water.
- When driving in rain, on water-covered roads, or through a car wash, water could get into the brake discs and make them fail temporarily. In such cases, lightly press the brake pedal to see if they are working properly. If they are not, press the pedal lightly several times while driving to dry the brake pads or linings, then check them again.
- When driving in rain, a layer of water may form between the tires and the road surface (aquaplaning). This loosens your tires' grip on the road, making it difficult to steer or brake properly. When driving on a wet road:
 - Drive your vehicle at a safe speed.
 - Do not drive on worn tires.
 - Always keep the tires at the correct inflation pressures.

On snowy or icy roads

- When driving on a road covered with snow or ice, use snow tires. Tire chains cannot be used on your vehicle. There may be state or local regulations about using snow tires. Always check the regulations in your local area before using them. Refer to the section entitled "Snow tires" on page 9-19 and "Tire chains" on page 9-20.
- Drive slowly. Do not make sudden starts or stops, sharp turns, or slam on the brakes.
- Allow extra distance between your vehicle and the vehicle in front of you, and avoid sudden braking.
- If a skid occurs when the accelerator pedal is depressed, take your foot off the pedal. Steer gently in the direction of the skid.
- Your vehicle is equipped with an anti-lock braking system (ABS). Hold the brake pedal down firmly and keep it depressed. Do not pump the brake pedal which will result in reduced braking performance.
- After parking on snowy or icy road, it may be difficult to move your vehicle due to freeze-up of the brake. Depress the accelerator pedal little by little to move the vehicle after confirming safety of the vehicle.

⚠ CAUTION

- Do not depress the accelerator pedal rapidly. The vehicle could start moving when it breaks free from the ice, possibly resulting in an accident.

On a bumpy or rutted road

Drive as slow as possible when driving on bumpy or rutted roads or over potholes etc.

⚠ CAUTION

- Driving on bumpy, rutted roads or over potholes can damage the tires and wheels. Wheels with low-profile tires or under-inflated tires are especially at risk for damage.
- The vehicle's body, bumper, muffler and other parts may be damaged if the vehicle is:
 - driven over a step (for example, at the entrance or exit of a parking lot);
 - parked too closely against a curb or parking block, or by the side of a road with curbstones;
 - driven on a steep slope;

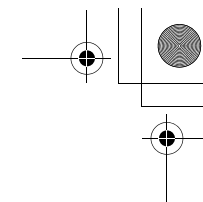
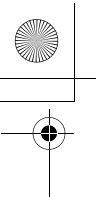

Fuel Pump Shut-off System

Fuel Pump Shut-off System

N00860600044

WARNING

- Before attempting to restart the engine after a collision, always inspect the ground under the vehicle for leaking fuel. If a fuel leak is found or a fuel odor is detected, do not restart the engine.
- Mitsubishi Motors recommends that your vehicle be inspected by an authorized Mitsubishi Motors dealer after any collision.

8

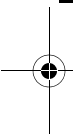

In the event of a collision causing frontal air-bag deployment, the fuel pump shut-off system will activate to stop fuel supply to the engine.

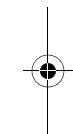

8-14 For emergencies

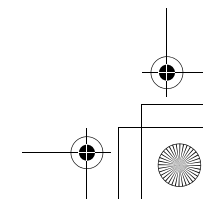
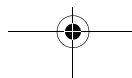
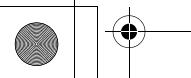



Vehicle care and maintenance

Service precautions	9-2
Catalytic converter	9-2
Engine hood	9-3
View of the engine compartment	9-5
Engine oil and oil filter	9-5
Engine coolant	9-7
Air cleaner filter	9-8
Manual transaxle oil (if so equipped)	9-9
Continuously variable transmission (CVT) fluid (if so equipped)	9-10
Washer fluid	9-10
Brake fluid/Clutch fluid (if so equipped).....	9-10
Battery	9-11
Tires	9-13
Clutch pedal free play (if so equipped).....	9-20
Brake pedal free play	9-20
Parking brake lever stroke	9-20
Parking brake break-in	9-20
Wiper blades	9-21
Emission-control system maintenance	9-21
General maintenance	9-22
For cold and snowy weather	9-23
Fusible links	9-24
Fuses	9-24
Replacement of light bulbs	9-29
Vehicle care precautions	9-39
Cleaning the inside of your vehicle	9-40
Cleaning the outside of your vehicle	9-41

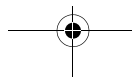
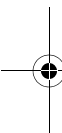

Service precautions

Service precautions

N00937301443

Taking regular care of your vehicle will preserve its value and appearance as long as possible.

You can do some of the maintenance work yourself, and the rest should only be performed by an authorized Mitsubishi Motors dealer or a repair facility of your choice.

If you discover a malfunction or other problem, have it corrected by an authorized Mitsubishi Motors dealer or a repair facility of your choice.

9

This section describes the maintenance inspections that you can do yourself, if you so desire. Follow the instructions and precautions for each procedure.

WARNING

- When checking or servicing the inside of the engine compartment, be sure the engine is stopped and has had a chance to cool down.
- If you need to work in the engine compartment with the engine running, be especially careful that your clothing, hair, etc. does not get caught in the fan, drive belts, or other moving parts.

WARNING

- After performing the maintenance work, make sure that no tools or cloths are left behind in the engine compartment. If they are left behind, a fire or damage to the vehicle may occur.
- The fan can turn on automatically even if the engine is not running. Turn the ignition switch to the "LOCK" position to be safe while you work in the engine compartment.
- Do not smoke or allow open flames around fuel or the battery. The fumes are flammable.
- Be extremely careful when working around the battery. It contains poisonous and corrosive sulfuric acid.
- Do not get under your vehicle while it is on a jack.
Always use properly rated automotive jack stands.
- Handling your vehicle's parts and materials in the wrong way can injure you. Ask an authorized Mitsubishi Motors dealer or a repair facility of your choice if you have questions.



DIAMOND CARE PROTECTION PLAN

Have you purchased the Mitsubishi Motors Diamond Care Protection Plan? The Plan supplements your new vehicle warranties. See your authorized Mitsubishi Motors dealer for details.

Catalytic converter

N00937400405

The catalytic converter requires you to use unleaded fuel only. Leaded gasoline will destroy the emission-control effectiveness of the converter.

Normally, the catalytic converter does not require maintenance. However, it is important to keep the engine properly tuned for the converter to continue to work properly.

Engine hood

⚠ CAUTION

- Damage to the catalytic converter can result if your vehicle is not kept in proper operating condition. If the engine malfunctions or misfires, or if your vehicle performance suffers, have it serviced promptly. Running your vehicle when it is overheated may result in damage to the converter and vehicle.

⚠ WARNING

- **Do not park or run your vehicle in areas where combustible materials such as dry grass or leaves can come in contact with a hot exhaust, since a fire could occur.**
- **Do not put undercoat paint on the catalytic converter.**

To reduce the possibility of catalytic converter damage:

- Use **UNLEADED GASOLINE ONLY** of the type of recommended in “Fuel selection”.
- Do not drive with an extremely low fuel level. Running out of gas could damage the catalytic converter.
- Do not try to start the engine by pushing or towing the vehicle. If the battery is weak or run down, use jumper cables to properly start the engine.

- Do not idle the engine with any spark plug wires disconnected or removed, such as when performing diagnostic tests.
- Do not idle the engine for a long time if it is idling roughly or otherwise obviously malfunctioning.
- To prevent the catalytic converter from being damaged from unburned gas, do not race the engine when turning off the ignition switch.
- Stop driving the vehicle if you think the performance is noticeably low, or the engine has a malfunction. If you are not able to stop driving immediately, slow down and drive for only a short time. Have an inspection made by an authorized Mitsubishi Motors dealer or a repair facility of your choice as soon as possible.
- In unusual situations involving major engine problems, a burning odor may indicate severe and abnormal catalytic converter overheating. If this occurs, stop in a safe place, shut the engine off and let the vehicle cool. Once the engine is cool, immediately take your vehicle to an authorized Mitsubishi Motors dealer or a repair facility of your choice for service.

Engine hood

N00937501605

To open

Use the engine hood release lever (located under the instrument panel near the driver's door) to unlock the engine hood.

Pull the lever toward you to release the engine hood latch.

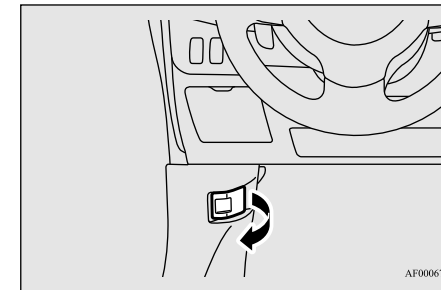

AF0006715

⚠ WARNING

- **Never use the release lever to unlatch the engine hood while the vehicle is in motion.**
- **Do not drive your vehicle unless the engine hood is locked.**

Engine hood

Release the safety lever and lift the engine hood.

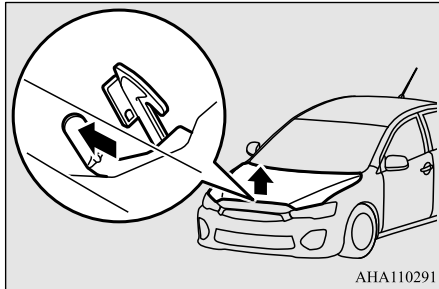

Support the engine hood with the hood prop. Insert the hood prop securely in the opening under the hood marked with an arrow.

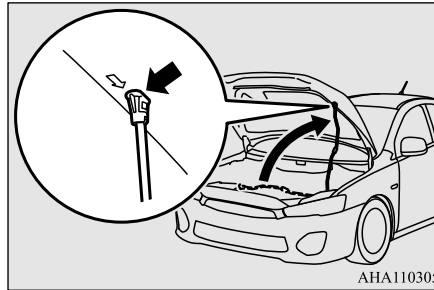

9

NOTE

- To prevent damage to the engine hood and wipers, make sure the wipers are at resting position when you open the engine hood.

CAUTION

- Always insert the support prop into the hole specially made for it. Propping the engine hood at any other place could cause the prop to slip out and lead to an accident.
- The hood prop can fall out if the hood is lifted by a strong wind.

To close

Unlatch the prop from the engine hood and put it back in its retainer.

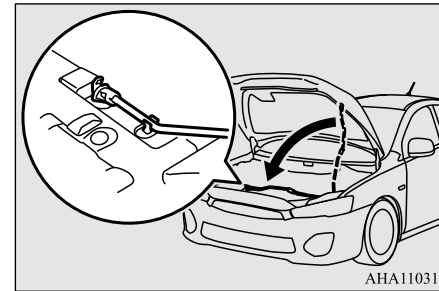

Slowly lower the engine hood about 8 inches (20 cm), then let it drop from its own weight.

CAUTION

- Be careful not to trap your hands or fingers when closing the engine hood.
- Make sure the engine hood is firmly closed before driving.
If you drive without the engine hood completely closed, it could open up while driving.

NOTE

- If this does not close the engine hood properly, drop it again from a slightly higher position.

NOTE

- Do not push down strongly on the engine hood. Depending on how strongly or where you push down, you could create a dent in the vehicle body.
- If you drive with the engine hood left open, warning display is displayed on the information screen in the multi-information display.

Type 1



Type 2



View of the engine compartment

N00937601765

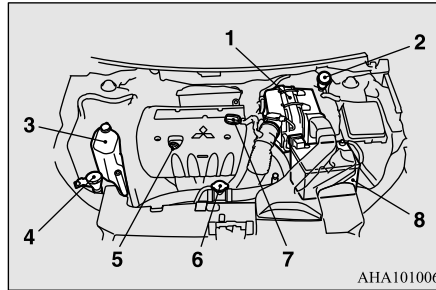

AHA101006

- 1- Air cleaner filter
- 2- Brake fluid/Clutch fluid reservoir (if so equipped)
- 3- Engine coolant reservoir
- 4- Windshield washer fluid reservoir
- 5- Engine oil level dipstick
- 6- Radiator cap
- 7- Engine oil filler cap
- 8- Battery

View of the engine compartment

Engine oil and oil filter

N00937702008

To check and refill engine oil

It is normal for an engine to use oil. You may need to add oil between the recommended oil change intervals. Before starting the engine, check the engine oil level. Refill if necessary.

To check the oil level, remove the dipstick, wipe it off, and gently insert it all the way into the crankcase. Slowly remove it again. The oil level must not go above the line on the dipstick.

If the level does not reach the line, which shows the smallest amount of oil required, remove the oil filler cap on the engine valve cover, and fill to within the "Good" range.

9

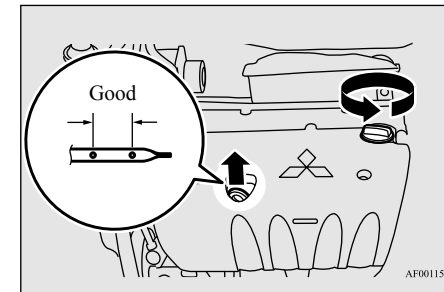

AF0011566

Engine oil and oil filter

⚠ CAUTION

- Overfilling the crankcase will cause oil aeration and loss of oil pressure, which could damage the engine.

⚠ WARNING

- Used engine oil is poisonous, and can damage your skin. Prolonged and repeated contact may cause serious skin disorders, including dermatitis and cancer. Don't let used oil touch your skin. Wash thoroughly after working with it.
- Keep used oil out of the reach of children.

9

📖 NOTE

- Engine oil consumption is greatly influenced by payload, engine speed, etc.
- The engine oil will deteriorate rapidly if the vehicle is subjected to severe conditions (for example, repeated operation on rough roads, in mountainous regions, on roads with many uphill and downhill gradients, or over short distances). Consequently, the oil will require earlier replacement in accordance with the schedule in the "WARRANTY AND MAINTENANCE MANUAL".

Engine oil identification mark

Mitsubishi Motors recommends using only engine oils with the ILSAC certification symbol on the front of the container.

ILSAC certification symbol



AHA100692

If you cannot find oils with the ILSAC certification symbol, use an API classification SN or higher oil with the following label.

This mark appears on the top of the oil container and tells you two important things about the oil.

API service symbol

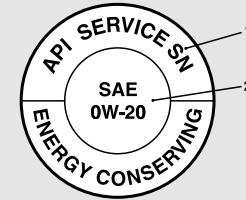

AH0000849

- 1- The top portion shows the quality of the oil.
- 2- The center portion shows the SAE grade of the oil viscosity.

Recommended engine oil viscosity

N00955001110

Use engine oil with the proper thickness for the outdoor temperatures where you will be driving.

Engine coolant

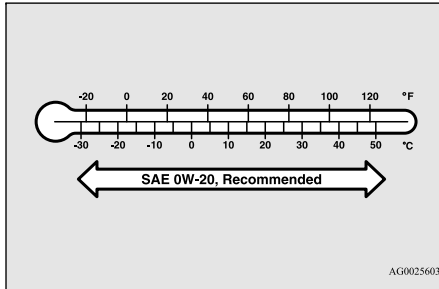

Mitsubishi Motors Genuine 0W-20 Synthetic Engine Oil is recommended for optimum fuel economy and cold weather starting.

If Mitsubishi Motors Genuine 0W-20 Synthetic Engine Oil is not available, 5W-20 grade oils displaying the ILSAC certification can be used. However, Mitsubishi Motors Genuine 0W-20 Synthetic Engine Oil should be used at the next oil change to maintain optimum fuel economy and cold weather starting.

To replace the oil filter

N00955100055

The oil filter should be replaced at the time or mileage specified in the “WARRANTY AND MAINTENANCE MANUAL”.

Only use high quality replacement filters on this vehicle. The manufacturer’s specifications for Genuine Mitsubishi oil filters

require that the filter can withstand a pressure of 256 psi (1.8 MPa). A Genuine Mitsubishi oil filter is the best replacement filter.

Follow the installation instructions printed on the filter.

Engine coolant

N00937801608

To check the coolant level

The coolant reserve tank (A) lets you quickly see when you need to add coolant. When the engine is cold, the level in the reserve tank should be between the “FULL” and “LOW” marks. The radiator usually stays full so there is no reason to remove the radiator cap (B) except when you check the coolant freeze point or replace the antifreeze coolant.

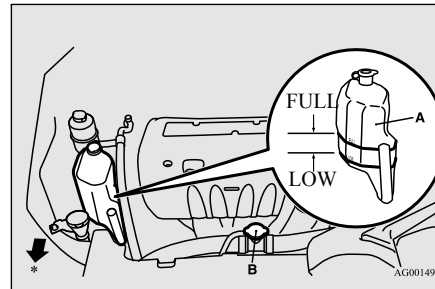

*- Front of the vehicle

To add coolant

Use “Mitsubishi Motors Genuine Super Long Life Coolant Premium” or an equivalent*.

*: similar high quality ethylene glycol based non-silicate, non-amine, non-nitrate and non-borate coolant with long life hybrid organic acid technology

Mitsubishi Motors Genuine Coolant provides excellent protection against corrosion and rust formation on all metals, including aluminum, and prevents blockages in some parts of engine.

If you need to add coolant often, or if the level in the reserve tank does not drop when the engine cools, the cooling system should be pressure-tested for leaks. Take your vehicle to an authorized Mitsubishi Motors dealer or a repair facility of your choice for testing.

CAUTION

- Do not use alcohol or methanol antifreeze or any engine coolants that contain them. Using the wrong antifreeze can corrode aluminum parts.

Air cleaner filter

CAUTION

- The required concentration of anti-freeze differs depending on the expected ambient temperature.
Above -31 °F (-35 °C) : 50 %concentration of anti-freeze
Below -31 °F (-35 °C) : 60 %concentration of anti-freeze
You can check the concentration level with a gauge from an automotive supply store, or your authorized Mitsubishi Motors dealer or service station can check it for you.
- Do not use water to adjust the concentration of coolant.
- Do not top off the tank with plain water only. Water by itself boils at a lower temperature and does not stop rust or freezing. If the water freezes, it will damage your cooling system. Do not use tapwater. It can cause corrosion and rust.

9

Radiator cap

The radiator cap must be tight sealed to prevent losing coolant which may result in engine damage. Only use a Genuine Mitsubishi Parts radiator cap, or an approved equivalent.

WARNING

- **Wait for the engine to cool down before opening the radiator cap. Otherwise hot steam or boiling coolant could spray up from the radiator and scald you.**

Points to remember

- Do not overfill the reserve tank.
- Your vehicle uses a special radiator cap that stays sealed and lets the coolant flow from the reserve tank back to the radiator when the engine cools down. If you need to change the cap, use the exact same kind.
- Check the coolant freeze point in the radiator with the proper gauge, and only when it is safe. If you add antifreeze, the contents of the reserve tank must be protected against freezing.
- Keep the front of the radiator and condenser clean.
- If the temperature of the engine coolant does not rise after the engine is warmed-up, take your vehicle to an authorized Mitsubishi Motors dealer or a repair facility of your choice to have the thermostat checked, and replaced if necessary.

Air cleaner filter

N00937901511

The air cleaner filter will get dirty and dusty from use and not filter properly. Replace it with a new filter using the schedule in the “WARRANTY AND MAINTENANCE MANUAL”.

1. Remove the two clips (A), then remove the duct (B).

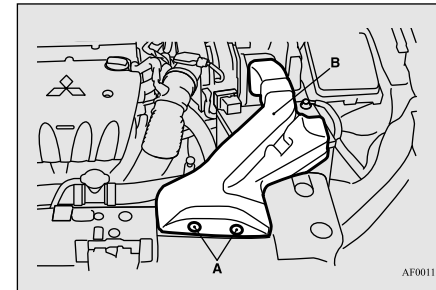

2. While holding down the tab (C), pull out the connector (D).

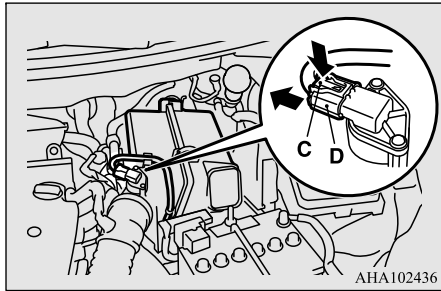

3. Remove the harness from the air cleaner hook (E).

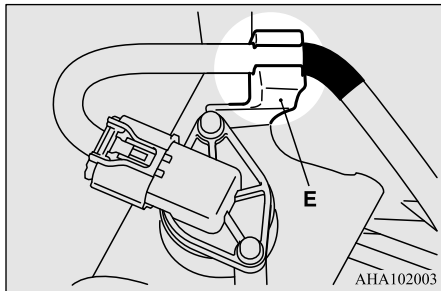

4. Unclamp and take out the air cleaner filter.

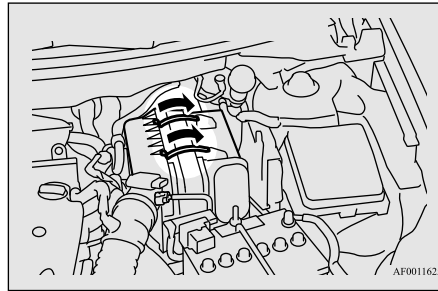

5. Install the air cleaner filter and put the cover back on in its original position.

NOTE

- Genuine Mitsubishi Motors Parts are recommended when replacing the air cleaner filter.
- After replacing the air cleaner filter, make sure that the hinges at the bottom of cover are firmly set.

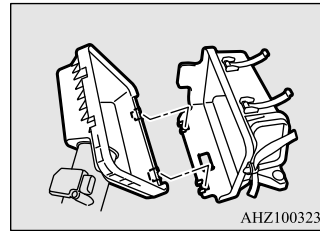

Manual transaxle oil (if so equipped)

NOTE

- After replacing the air cleaner filter, make sure the harness is firmly set so that the air cleaner hook (E) and the marking tape (F) on the harness are located as shown in the illustration.

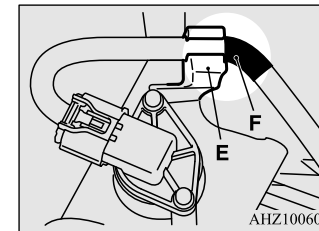

- Make sure that the connector is properly reconnected.

6. Put the duct back on in its original position.

Manual transaxle oil (if so equipped)

N00938200165

Whenever the manual transaxle oil level is checked, add oil to maintain the proper level, if necessary.

Refill or change the oil according to the table.

Continuously variable transmission (CVT) fluid (if so equipped)

Oil type

Lubricant	Mitsubishi Motors Genuine NEW MULTI GEAR OIL API Classification GL-3
Viscosity range	SAE 75W-80

Continuously variable transmission (CVT) fluid (if so equipped)

9

N00938101116

The continuously variable transmission (CVT) should be maintained and serviced by an authorized Mitsubishi Motors dealer or a repair facility of your choice to obtain the best performance and longest life. It is important that the transmission fluid is kept at the correct level.

Fluid type

Use only “Mitsubishi Motors Genuine CVTF-J4” transmission fluid to ensure optimum transmission performance.

CAUTION

- Using the improper transmission fluid may damage the transaxle.

Special additives

Mitsubishi Motors Corporation does not recommend the addition of any fluid additives to the transmission.

Washer fluid

N00938600273

The windshield washer fluid reservoir is in the engine compartment. Check the washer fluid level at regular intervals and add washer fluid to reservoir if necessary. Open the reservoir cap and check the fluid level with the dipstick.

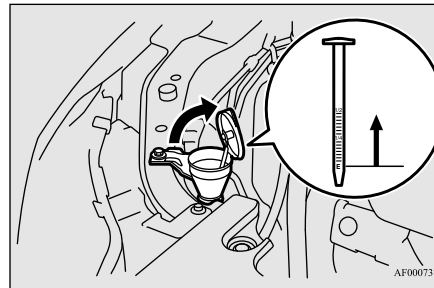

During cold weather

When freezing weather is anticipated, flush out the water in the reservoir by operating the pump. Fill the reservoir with windshield anti-freeze (not radiator antifreeze), and operate the system for a few seconds to flush out the residual water.

Brake fluid/Clutch fluid (if so equipped)

N00938700216

The brake fluid and the clutch fluid share the reservoir tank.

To check the fluid level

The fluid level must be between the “MAX” and “MIN” marks on the reservoir.

Battery

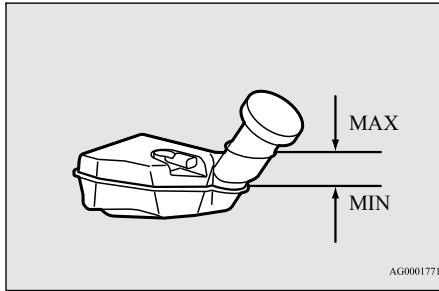

The fluid level falls slightly with wear of the brake pads, but this does not indicate any abnormality.

The fluid in the master cylinder should be checked when doing other work under the engine hood. The brake system should also be checked for leaks at the same time.

If the fluid level falls markedly in a short length of time, it indicates leaks from the brake system.

If this occurs, have the vehicle checked by an authorized Mitsubishi Motors dealer or a repair facility of your choice.

Fluid type

Use brake fluid conforming to DOT 3 or DOT 4. The reservoir cap must be tightly sealed to keep dirt and water out.

CAUTION

- Do not let any petroleum-based fluid touch, mix with, or get into the brake fluid. This will damage the seals.
- Be careful when handling brake fluid. It can damage painted surfaces.
- Use only the listed brake fluid. Different brands of brake fluid have different additives, and these can cause a chemical reaction. Do not mix brands of brake fluid.
- Keep the reservoir tank cap closed to keep the brake fluid from evaporating.

Battery

N00939100826

The condition of the battery is very important for quick starting and to keep the vehicle's electrical system working properly. Check the battery regularly.

WARNING

- An SRS airbag sensor is located in the front of the engine compartment near the battery. When checking or replacing the battery, or when working around this area, do not strike or damage this sensor.

Checking battery electrolyte level

N00901501079

The electrolyte level must be between the limits shown on the outside of the battery. Fill it with distilled water as needed. The inside of the battery is divided into several compartments. Take the cap off of each compartment and fill to the mark.

Do not fill above the top line because a spill during driving could cause damage.

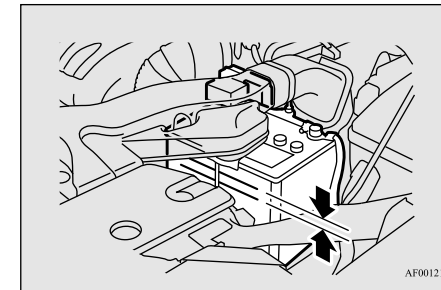

9

WARNING

- If the battery goes flat, be sure to check the battery electrolyte level before connecting booster cables.
- After checking the battery electrolyte level, make sure the caps are fitted securely.

Battery

⚠ WARNING

- If any of the caps has a loose fit, replace the battery.

During cold weather

N0090160028

The battery is weaker in cold temperatures. This has to do with its chemical and physical properties and is why a very cold battery, especially one with a low charge, will have a hard time starting your vehicle.

It is recommended that you have your battery and charging system checked by an authorized Mitsubishi Motors dealer or a repair facility of your choice before the start of cold weather. If necessary, have it charged. This will guarantee more reliable starting, and longer battery life.

9

Disconnection and connection

N00901701127

To disconnect the battery cable, stop the engine. Disconnect the negative (-) terminal first, then the positive (+) terminal. To reconnect the battery, first connect the positive (+) terminal and then the negative (-) terminal, before starting the vehicle.

📖 NOTE

- Open the terminal cover (A) before disconnecting or connecting the positive (+) terminal of the battery.

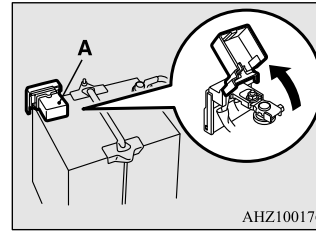

AHZ100176

⚠ WARNING

- Never disconnect the battery while the engine is running, or you could damage the vehicle's electrical parts.
- Never short-circuit the battery. This could cause it to overheat and be damaged.
- Keep sparks, cigarettes, and flames away from the battery because the battery could explode.
- Electrolyte (battery acid) is made of corrosive diluted sulfuric acid. If it spills on nearby parts, it can crack, stain, or discolor them. And if gets on your skin or in your eyes, it can cause burns or blindness. Please observe the following handling instructions:

⚠ WARNING

- If electrolyte gets on plastic parts or other nearby parts, wipe it off with a soft cloth or chamois soaked in a solution of water and neutral detergent then immediately rinse the affected parts with plenty of water.
- If electrolyte gets on your hands or clothes, rinse thoroughly with water. If electrolyte gets in your eyes, flush them with water immediately and get immediate medical attention.
- Open doors and windows in any closed space where you may be charging or working with the battery.
- Always wear protective clothing and goggles when working with the battery, or have a skilled automobile technician do it.
- If you are quick-charging your battery, first disconnect the battery cables.
- In order to prevent a short circuit, be sure to disconnect the negative (-) terminal first, and reconnect it last.
- If the electrolyte level is very low, have the battery checked at an authorized Mitsubishi Motors dealer or a repair facility of your choice.
- Battery terminals and related accessories contain lead and lead compounds. Wash hands after handling.

Tires

 NOTE

- Check each battery terminal for corrosion. You can stop more corrosion by washing with a solution of baking soda and water. Grease the posts and clamps after cleaning or tightening them.
- Check to see that the battery is securely installed and cannot be moved. Also check each terminal for tightness.
- If you will not be driving your vehicle for a long period of time, remove the battery and store it in a place where the battery fluid will not freeze. Memory data for settings made by the user may be erased when the battery is removed. If this happens, reset the settings again using the relevant procedures. The battery only should be stored with a full charge.
- Before cleaning the battery, tighten all the filler port caps to keep dirt and moisture out.

Tires

N00939201563

 WARNING

- **Driving with tires that are worn, damaged or improperly inflated is dangerous. These type tire conditions will adversely affect vehicle performance. These type tire conditions can also cause a tread separation or blowout which may result in an accident causing serious injury or death.**

 WARNING

- **Tires, including spare tire, degrade over time with age even when they are not being used. It is recommended that tires over 6 years generally be replaced even if damage is not obvious.**

It is important to familiarize yourself with the following terms:

- Cold tire pressure:
 - The measured pressure after the vehicle has been parked for at least three hours, or
 - The measured pressure when the vehicle is driven less than 1 mile (1.6 km) after having been parked for three hours.
- Maximum inflation pressure: the maximum permissible cold tire inflation pressure for this tire.
- Recommended inflation pressure: the inflation pressure for optimum tire performance.
- Intended outboard sidewall:
 - The sidewall that contains a whitewall, bears white lettering or bears manufacturer, brand, and/or model name molding that is higher or deeper than the same molding on the other sidewall of the tire, or
- The outward facing sidewall of an asymmetrical tire that has a particular side that must always face outward when mounted on a vehicle.
- Passenger car tire: a tire intended for use on passenger cars, multipurpose passenger vehicles, and trucks, that have a gross vehicle weight rating (GVWR) of 10,000 pounds or less.
- Light truck (LT) tire: a tire designated by its manufacturer as primarily intended for use on lightweight trucks or multipurpose passenger vehicles.
- Tread: portion of a tire that comes into contact with the road.
- Tread rib: a tread section running circumferentially around a tire.
- Tread separation: pulling away of the tread from the tire carcass.
- Carcass: the tire structure, except tread and sidewall rubber which, when inflated, bears the load.
- Sidewall: portion of a tire between the tread and bead.
- Section width: the linear distance between the exteriors of the sidewalls of an inflated tire, excluding elevations due to labeling, decoration, or protective bands.
- Bead: the part of the tire that is made of steel wires, wrapped or reinforced by ply cords and that is shaped to fit the rim.

Tires

- Ply: a layer of rubber-coated parallel cords.
- Cord: the strands forming the plies in the tire.
- Rim: a metal support for a tire or a tire and tube assembly upon which the tire beads are seated.
- Rim diameter: nominal diameter of the bead seat.
- Groove: the space between two adjacent tread ribs.

Tire Markings

9

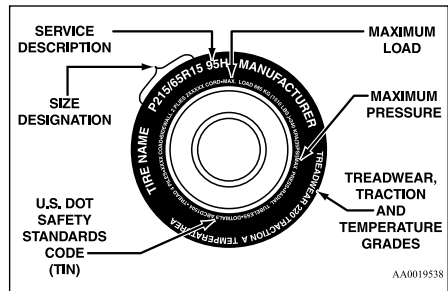

Size Designation

EXAMPLE: P215/65R15

P	Passenger car tire size based on U.S.A. design standards
215	Section width in millimeters (mm.)
65	Aspect ratio in percent (%) Ratio of section height to section width of tire.
R	Construction code •“R” means radial construction. •“D” means diagonal or bias construction.
15	Rim diameter in inches (in)

NOTE

- European/Japanese metric tire sizing is based on European/Japanese design standards. Tires designed to these standards have the tire size molded into the sidewall beginning with the section width. The letter “P” is absent from this tire size designation. Example: 215/65R15 96H.
- LT (Light Truck) -metric tire sizing is based on U.S.A. design standards. The size designation for LT-metric tires is the same as for P-metric tires except for the letters “LT” that are molded into the sidewall preceding the size designation. Example: LT235/85R16.

NOTE

- Temporary spare tires are high pressure compact spares designed for temporary emergency use only. Tires designed to this standard have the letter “T” molded into the sidewall preceding the size designation. Example: T145/80D18 103M.

Service Description

EXAMPLE: 95H

95	<p>Load index A numerical code associated with the maximum load a tire can carry.</p>
----	---

H	<p>Speed symbol A symbol indicating the range of speeds at which a tire can carry a load corresponding to its load index under certain operating conditions. The maximum speed corresponding to the speed symbol should only be achieved under specified operating conditions. (i.e. tire pressure, vehicle loading, road conditions and posted speed limits)</p>
---	---

Maximum Load

Maximum load indicates the maximum load this tire is designed to carry.

WARNING

- **Overloading of your tire is dangerous. Overloading can cause tire failure, affect vehicle handling, and increase your stopping distance. Use tires of the recommended load capacity for your vehicle. Never overload them.**

Maximum Pressure

Maximum Pressure indicates the maximum permissible cold tire inflation pressure for this tire.

Tire Identification Number (TIN)

The TIN may be found on one or both sides of the tire but the date code may only be on one side. Look for the TIN on the outboard side of tires as mounted on the vehicle. If the TIN is not found on the outboard side then you will find it on the inboard side of the tire.

Tires

EXAMPLE: DOT MA L9 ABCD 1504

DOT	Department of Transportation This symbol certifies that the tire is in compliance with the U.S. Department of Transportation tire safety standards, and is approved for highway use.
MA	Code representing the tire manufacturing location. (2 digits)
L9 ABCD	Code representing the tire size. (2 digits) Code used by tire manufacturer. (1 to 4 digits)
15	Number representing the week in which the tire was manufactured. (2 digits)
04	Number representing the year in which the tire was manufactured. (2 digits)

9

Treadwear, Traction and Temperature Grades

Treadwear

The treadwear grade is a comparative rating based on the wear rate of the tire when tested under controlled conditions on a specified government test course. For example, a tire graded 150 would wear one and one-half (1¹/₂) times as well on the government course as a tire graded 100. The relative performance of tires depends upon the actual conditions of their use, however, and may depart significantly from the norm due to variations in driving habits, service practices and differences in road characteristics and climate.

Traction

The traction grades, from highest to lowest, are AA, A, B and C. Those grades represent the tire's ability to stop on wet pavement as measured

under controlled conditions on specified government test surfaces of asphalt and concrete. A tire marked C may have poor traction performance.

Temperature

The temperature grades are A (the highest), B and C, representing the tire's resistance to the generation of heat and its ability to dissipate heat when tested under controlled conditions on a specified indoor laboratory test wheel. Sustained high temperature can cause the material of the tire to degenerate and reduce tire life, and excessive temperature can lead to sudden tire failure. The grade C corresponds to a level of performance which all passenger car tires must meet under the Federal Motor Vehicle Safety Standard No. 109. Grades B and A represent higher levels of performance on the laboratory test wheel than the minimum required by law.

Tire inflation pressures

N00939301942

Proper tire inflation pressure is essential for the safe and satisfactory operation of your vehicle. The wrong tire pressure will cause problems in three major areas:

- Safety

Too little pressure increases flexing in the tire and can cause tire failure. Too much pressure can cause a tire to lose its ability to cushion shock. Objects on the road and potholes could then cause tire damage that may result in tire failure.

- Economy

The wrong tire pressure can cause uneven wear patterns in the tire tread. These abnormal wear patterns will reduce the tread life, and the tire will have to be replaced sooner.

Too little pressure also makes it harder for the tire to roll, and this uses up more fuel.

- Ride comfort and vehicle stability

The superior riding experience built into your vehicle partly depends on the correct tire pressure. Too much pressure gives an uncomfortable and jarring ride. Too little pressure feels as if your vehicle is slow to respond.

Unequal tire pressures can make steering your vehicle uneven and unpredictable.

The correct tire pressure for your vehicle is listed on the placard attached to the driver's door sill.

(Refer to "Tire and loading information placard" on page 11-3.)

The recommended inflation pressures should be used for the tires listed below.

Item	Tire size	Front	Rear
Normal tire	P205/60 R16	250 KPA, 36 PSI	250 KPA, 36 PSI
Compact spare tire	T125/70 D16	420 KPA, 60 PSI	

Tire pressures should be checked, and adjusted if necessary, at least once a month.

Pressures should be checked more often whenever weather temperatures change severely, because tire pressures change with outdoor temperatures. The pressures listed on the placard are always "cold inflation pressure".

Cold inflation pressure is measured after the vehicle has been parked for at least three hours or is driven less than 1 mile (1.6 km) after having been parked for three hours.

Cold inflation pressure must not go above the maximum values molded into the tire sidewall. After driving several miles, your tire inflation pressure may increase 14 to 41 KPA, 2 to 6 PSI from the cold inflation pressure.

Tires

Do not let air out of the tires to get back to the specified cold pressure, or your tire pressure will be too low.

Check your tires each time you refuel. If one tire looks lower than the others, check the pressure for all of them.

You should also take the following safety precautions:

- Keep your tires inflated to the recommended pressures. (See the tire and loading information placard attached to the driver's door sill.)
- Stay within the recommended load limits.
- Make sure that the weight of any load in your vehicle is evenly distributed.
- Drive at safe speeds.
- After filling your tires to the correct pressure, check them for damage and air leaks. Be sure to reinstall the caps on the valve stems.

9

Replacing tires and wheels

N00939601437

⚠ CAUTION

- Avoid using different size tires and wheels from the ones listed, and avoid the combined use of different types of tires and wheels. Using different size or type tires and wheels may affect driving safety. Refer to "Tires and wheels" on page 11-5.

Tires

CAUTION

- Even if a wheel has the same rim size and offset as the specified type of wheel, its shape may prevent it from being fitted correctly. Consult an authorized Mitsubishi Motors dealer or a repair facility of your choice before using wheels that you have.
- Only Mitsubishi Motors genuine wheels should be used, because your vehicle is equipped with a tire pressure monitoring system. Use of another type of wheel risks air leaks and sensor damage, as it will not be possible to install the tire pressure sensor properly.

9

Tire maintenance

The following maintenance steps are recommended:

- Check tire pressures regularly.
- Have regular maintenance done on the wheel balance and front and rear suspension alignment.
- Rotate your tires regularly as described in the “Tire rotation” section on page 9-18.

Tread wear indicators

N00939800227

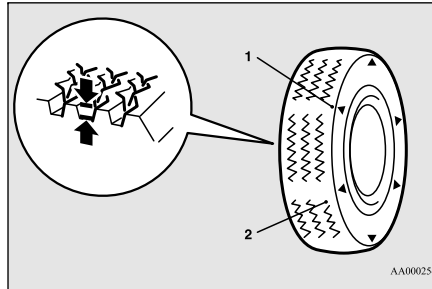

- 1- Location of the tread wear indicator
- 2- Tread wear indicator

Tread wear indicators are built into the original equipment tires on your vehicle to help you know when your tires should be replaced. Many states have laws requiring that you replace your tires at this point. These indicators are molded into the bottom of the tread grooves and will appear when the tire tread is worn down to 1/16 inch (1.6 mm). When the bands appear next to one another in two or more places, replace your tires.

NOTE

- Tire wear indicators can have different marks and locations depending on the tire manufacturer.

Tire rotation

N00939900491

To even out the wear on your tires and make them last longer, Mitsubishi Motors Corporation recommends that you rotate your tires at the mileage listed in the “WARRANTY AND MAINTENANCE MANUAL”.

However, the timing for tire rotation may vary according to your vehicle condition, road surface conditions, and your own personal driving habits. Any time you notice unusual wear, rotate your tires as soon as possible.

When rotating tires, check for uneven wear, damage, and wheel alignment. Abnormal wear is usually caused by a wrong tire pressure, wheels that are not aligned properly, wheels that are out-of-balance, or severe braking.

Check with an authorized Mitsubishi Motors dealer or a repair facility of your choice to find out the reason for uneven tread wear.

The first tire rotation is the most important one. It will allow all your tires to wear evenly.

Tires

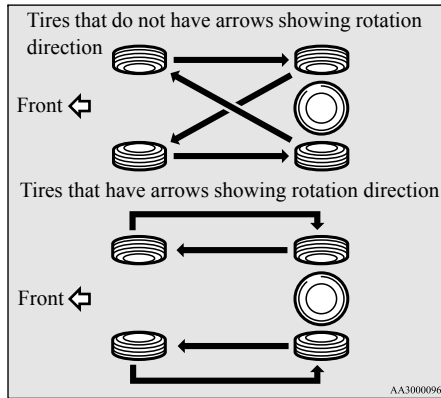

CAUTION

- If the tires have arrows (A) indicating the correct direction of rotation, swap the front and rear tires on the left-hand side of the vehicle and the front and rear tires on the right-hand side of the vehicle separately. Keep each tire on its original side of the vehicle. When installing the tires, make sure the arrows point in the direction in which the wheels will turn when the vehicle moves forward. Any tire whose arrow points in the wrong direction will not perform to its full potential.

Snow tires

N00940000359

In some areas of the country, snow tires are required for winter driving. If snow tires are required in your area, you must choose snow tires of the same size and type as the original tires provided with your vehicle. Snow tires should also be installed on all four wheels. Otherwise your safety and vehicle handling can be reduced.

Even where laws may permit it, snow tires should not be operated at sustained speeds over 75 mph (120 km/h).

CAUTION

- A compact spare tire can be installed temporarily in place of a tire that has been removed during the tire rotation. However, it must not be included in the regular tire rotation sequence.

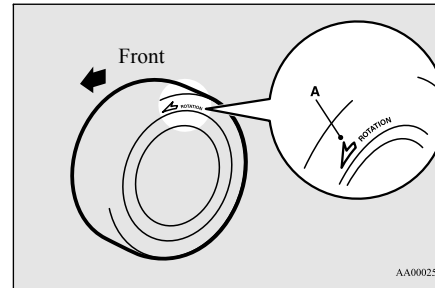

CAUTION

- If flange nuts are used on your vehicle, change to tapered nuts when using snow tires with steel wheels.
- Only Mitsubishi Motors genuine wheels should be used, because your vehicle is equipped with a tire pressure monitoring system. Use of another type of wheel risks air leaks and sensor damage, as it will not be possible to install the tire pressure sensor properly.

CAUTION

- Avoid the combined use of different types of tires. Using different types of tires can affect vehicle performance and safety.

Clutch pedal free play (if so equipped)

Tire chains

N00940100129

CAUTION

- Tire chains cannot be used on your vehicle. The clearance between the chains and the body is not sufficient to allow proper clearance, and the vehicle body might be damaged.

Clutch pedal free play (if so equipped)

N00940201097

9

To check the clutch pedal free play (A), turn off the engine and press the pedal until you feel resistance.

Clutch pedal free play:
.2 to .4 inch (4 to 9 mm)

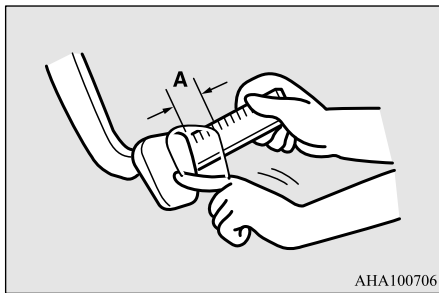

AHA100706

Brake pedal free play

N00940301333

To check the brake pedal free play (A), turn off the engine and press the brake pedal several times with your foot. Then press the pedal down with your fingers until you first feel resistance.

Brake pedal free play:
.1 to .3 inch (3 to 8 mm)

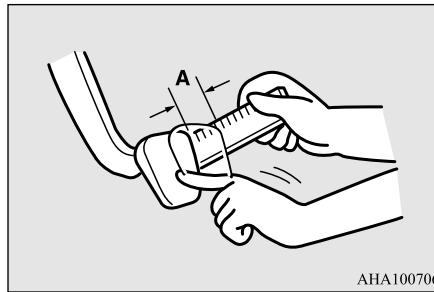

AHA100706

If the free play is not within these limits, take your vehicle to an authorized Mitsubishi Motors dealer or a repair facility of your choice for adjustment.

Parking brake lever stroke

N00940400180

Check the parking brake lever travel occasionally. To check this, pull the lever up slowly and count the number of clicks of the ratchet.

Parking brake lever stroke:
3 to 5 notches

Also check to see if the lever stays gripped by the ratchet after pulling.

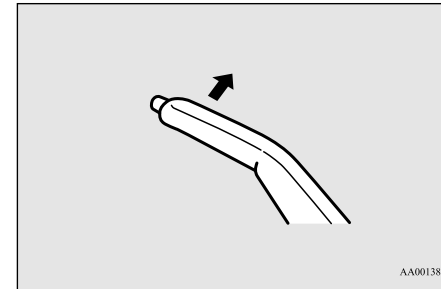

AA0013839

Parking brake break-in

N00936200057

Break-in the parking brake linings whenever the brake performance of the parking brake is insufficient or whenever the parking brake linings and/or discs are replaced, in order to assure the best brake performance.

This procedure is described in the vehicle service manual and can be carried out by an authorized Mitsubishi Motors dealer.

Wiper blades

N00940700170

Check the wiper blades occasionally. Clean them regularly to remove deposits of salt and road film. Use a sponge or cloth and a mild detergent or non-abrasive cleaner to clean the blades and glass areas.

Replace the blades if they continue to streak or smear.

NOTE

- Do not run the wipers on dry glass for a long time. This wears out the rubber and can scratch the glass.

During cold weather

If the blades are frozen to the windshield or rear window, do not operate the wipers until the ice has melted and the blades are freed, otherwise the wiper motor may be damaged.

Emission-control system maintenance

N00940800201

Your vehicle is equipped with an emission-control system that meets all the requirements of the U.S. Environmental Protection Agency and Environment Canada. The emission-control system is made of:

- a positive crankcase ventilation system
- an evaporative emission-control system
- an exhaust emission-control system

The maintenance services listed in the “WARRANTY AND MAINTENANCE MANUAL” must be performed at the times or mileages listed to keep the emission-control system working properly. These, and all the other “general” maintenance services listed in this manual, need to be performed to keep your vehicle running properly and reliably.

You may need more frequent maintenance if you drive your vehicle in harsh conditions such as dusty areas or do a lot of start-and-stop driving.

To be sure the emission-control system works properly, have your vehicle inspected and maintained by an authorized Mitsubishi Motors dealer or a repair facility of your

Wiper blades

choice following the schedule in the “WARRANTY AND MAINTENANCE MANUAL”.

You should also have an inspection and service any time you suspect a malfunction.

NOTE

- To meet government regulations and promote cleaner air, your vehicle is equipped with an onboard diagnostic system (OBD). The engine electronic control module that controls OBD functions stores various data (especially about the exhaust emissions). This data will be erased if the battery cable is disconnected, which could make a rapid diagnosis difficult. Do not disconnect the battery cable when the engine malfunction indicator (“SERVICE ENGINE SOON” or “Check engine light”) is on.

9

Spark plugs

N00940900257

Spark plugs must fire properly for good engine performance and emission-control.

Do not reuse them by cleaning or regapping. Change them at the mileage listed in the “WARRANTY AND MAINTENANCE MANUAL”.

General maintenance

NOTE

- Use the spark plugs listed under “Engine specifications” on page 11-5 or plugs that are exactly the same. Other plugs could cause engine damage, performance problems or radio noise.

Fuel hoses

N0094100037

Check the hose surfaces for any heat and mechanical damage, hard and brittle rubber, cracking, tears, cuts and abrasions. Pay special attention to the hoses closest to high heat sources such as the exhaust manifold. Check all the hose connections, such as clamps and couplings, to make sure they are secure and that there are no leaks. If you see any wear or damage, replace the hoses immediately.

9

Intake valve clearance

N00950100050

Have the valve clearance checked at an authorized Mitsubishi Motors dealer at the mileage specified in the “WARRANTY AND MAINTENANCE MANUAL”.

If the engine sounds abnormally loud, have adjustments made by an authorized Mitsubishi Motors dealer.

Fuel system (tank, pipe line and connection, and fuel tank filler cap)

N00941300186

Check these regularly for damage or leaks in the fuel lines and connections. Check the fuel tank filler cap for damage or looseness. Pay special attention to the fuel lines closest to high heat sources such as the exhaust manifold.

WARNING

- **If you see a fuel leak or if you smell fuel, do not run the engine. Any spark (including from the ignition), flame or smoking material could cause an explosion or fire. Call an authorized Mitsubishi Motors dealer or a repair facility of your choice for assistance.**

Evaporative emission control system (except evaporative emission canister)

N00941400116

If the fuel-vapor vent line is clogged or damaged, the fuel-vapor mixture will escape, polluting the air.

Have the system checked at an authorized Mitsubishi Motors dealer at the mileage spec-

ified in the “WARRANTY AND MAINTENANCE MANUAL”.

General maintenance

N00941500159

The next pages list the maintenance service recommended by Mitsubishi Motors Corporation. In addition to the general maintenance that needs to be performed at the times listed, there are other parts which do not usually need regular maintenance.

But, if any of these parts stops working properly, your vehicle performance could suffer. Have these items checked if you notice a problem with them.

See your authorized Mitsubishi Motors dealer for assistance, if you have any questions.

Disc brake pads

N00941600075

Good brakes are essential to safe driving. Check the brake pads for wear. For good braking performance, replace the brake pads with the same type pads as the originals.

Brake hoses

N00941700047

Brake hoses and tubing should be checked for:



- Severe surface cracking, scuffing or worn spots. If the fabric casing of the hose is showing through any cracks or worn spots in the rubber hose cover, the hose should be replaced. The brakes can fail if the hose wears through.
- Improper installation may cause twisting, or wheel, tire or chassis interference.

Ball joint, steering linkage seals and drive shaft boots

N0094180077

Check the following parts for damage and grease leaks:

- Ball joint boots of the front suspension and steering linkage
- Bellows on both ends of the drive shaft

Exhaust system

N00942200108

⚠ WARNING

- Carbon monoxide gas from your vehicle's exhaust is poisonous. Breathing these fumes can cause unconsciousness or death.

The best way to keep carbon monoxide gas from entering inside your vehicle is to have the engine exhaust system properly serviced.

Have a competent mechanic inspect the complete exhaust system and nearby body areas for broken, damaged, deteriorated, or mispositioned parts if you notice any of the following:

- A change in the sound of the exhaust system
- The smell of exhaust fumes inside the vehicle
- The underside or rear of the vehicle is damaged

Also check the exhaust system each time the vehicle is raised for lubrication, oil changes, or required service. Any open seams or loose connections could let dangerous exhaust fumes seep into the luggage compartment and passenger compartments.

Check for any of the following conditions:

- Check for holes or exhaust gas leaks caused by corrosion or damage.
- Check the joints and connections for looseness or exhaust gas leaks.
- Check the rubber hangers and brackets for damage.

For cold and snowy weather

Hood lock release mechanism and safety catch

N00942500114

The hood lock release mechanism and hood safety catch should be checked, cleaned, and oiled when needed for easy movement and to stop rust and wear. Use Multipurpose Grease NLGI Grade 2 sparingly for all sliding parts of the hood latch and release lever. Work the grease into the hood lock mechanism until all the movable surfaces are covered.

Also, put a light coat of the same grease on the safety catch wherever moving parts touch.

9

For cold and snowy weather

N00942600102

Ventilation slots

The ventilation slots in front of the windshield should be brushed clear after a heavy snowfall so that the operation of the heating and ventilation systems will not be impaired.

Weatherstripping

To prevent freezing of the weatherstripping on the doors, engine hood, etc., they should be treated with silicone grease.

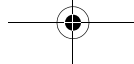

Fusible links

Additional equipment (For regions where snow is encountered)

It is a good idea to carry a shovel or a short-handled spade in the vehicle during the winter so that you can clear away snow if you get stranded. A small hand-brush for sweeping snow off the vehicle and a plastic scraper for the windshield, side and rear window are also useful.

9

Fusible links

N00942700259

The fusible links will melt to prevent a fire if a large current attempts to flow through certain electrical systems.

In case of a melted fusible link, see your authorized Mitsubishi Motors dealer or a repair facility of your choice for inspection and replacement.

For the fusible links, please refer to “Fuse load capacities” on page 9-25.

! WARNING

- Fusible links must not be replaced by any other device. Failing to fit the correct fusible link may result in fire in the vehicle, property destruction and serious or fatal injuries at any time.

9-24 Vehicle care and maintenance

Fuses

N00942800898

Fuse block location

To prevent damage to the electrical system from short-circuiting or overloading, each individual circuit is equipped with a fuse. The fuse blocks are located in the passenger compartment and in the engine compartment.

Passenger compartment

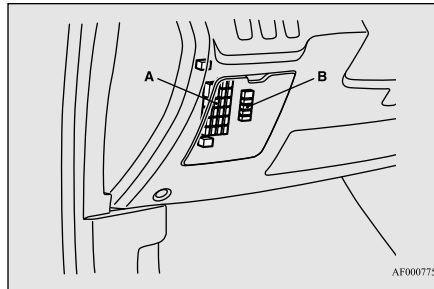

- A- Main fuse block
- B- Sub fuse block

The fuse blocks in the passenger compartment are located behind the fuse lid on the driver's side as shown.

1. Open the fuse lid and pull to remove it.

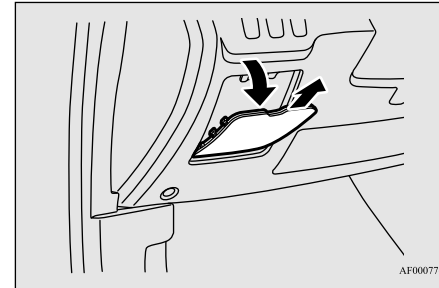

2. For vehicles equipped with the bottom cover, use the puller to loosen the 2 clips (A) and push down the bottom cover. The puller is in the fuse block in the engine compartment. Refer to “Fuse replacement” on page 9-28.

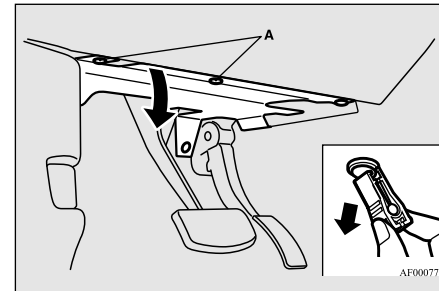

WARNING

● When changing fuses, do not damage the driver's knee airbag harness or accidentally strike the airbag area with hard objects. Improper work methods could result in an accidental driver's knee airbag deployment or could make the driver's knee airbag inoperable. Either of these situations could result in serious injury or death.

NOTE

● When finished, be sure to return the puller to the fuse block in the engine compartment.

3. To put back the fuse lid, line up the fuse lid hook (B) with the clamp (C) on the instrument panel and push the lid back in.

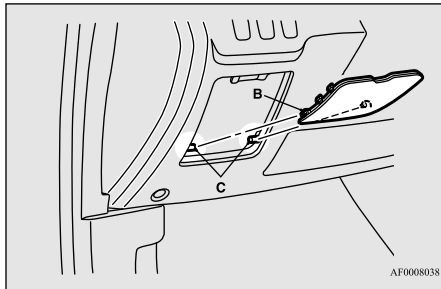

Engine compartment

In the engine compartment, the fuse block is located as shown in the illustration.

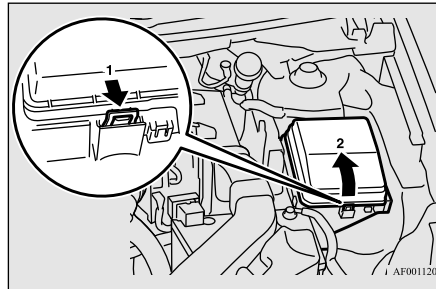

1. Push the lock lever.
2. Remove the fuse block cover.

Fuse load capacities

N00954801371

This fuse list shows the names of the electrical systems and their fuse capacities. There are spare fuses in the cover of the fuse block in the engine compartment. Always replace a blown fuse with one of the same capacity as the original.

Passenger compartment fuse location table

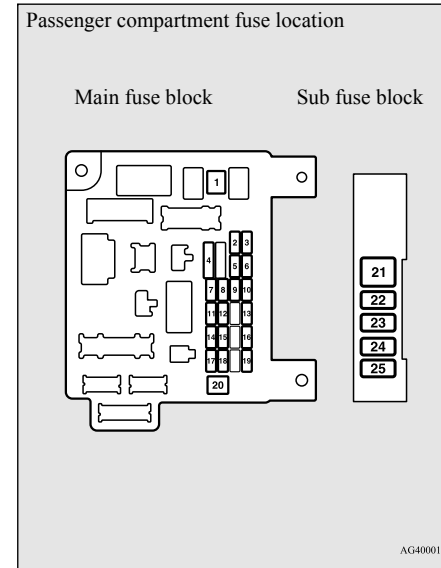

No.	Sym- bol	Electrical system	Capac- ity
1		Heater	30 A*
2	STOP	Stop lights (Brake lights)	15 A
3		Rear fog light	10 A

Fuses

No.	Symbol	Electrical system	Capacity
4		Windshield wiper	30 A
5		Optional	10 A
6		Door locks	20 A
7		Radio	15 A
8		Control unit relay	7.5 A
9		Interior lights (Dome lights)	15 A
10		Hazard warning flasher	15 A
11		Rear window wiper	15 A
12		Gauges	7.5 A
13		Cigarette lighter/Accessory socket	15 A
14		Ignition switch	10 A
15		Sunroof	20 A
16		Outside rearview mirrors	10 A
17		All-wheel drive system	10 A
18		Back-up lights	7.5 A
19		Accessory socket	15 A

9

No.	Symbol	Electrical system	Capacity
20		Power window control	30 A*
21		Defogger	30 A*
22		Heated outside rearview mirrors	7.5 A
23		115V Power outlet	15 A
24		Power seats	25 (20) A
25		Heated seats	30 A

*- Fusible link

- Some fuses may not be installed on your vehicle, depending on the vehicle model or specifications.
- The table above shows the main equipment corresponding to each fuse.



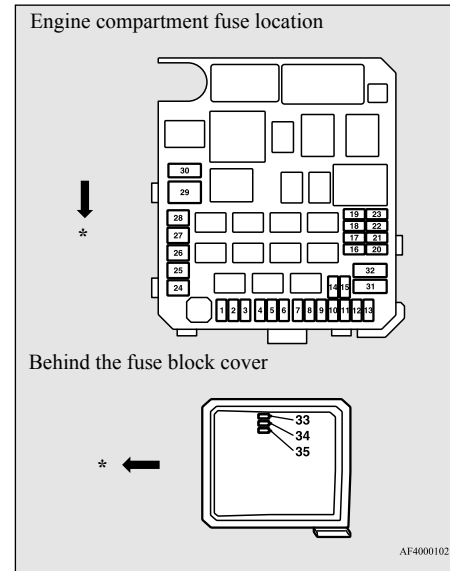











Engine compartment fuse location table



















*- Front of the vehicle

No.	Symbol	Electrical system	Capacity
1		Front fog lights	15 A
2		Engine	7.5 A

Fuses

No.	Symbol	Electrical system	Capacity
3		Automatic transaxle	20 A
4		Horn	10 A
5		Alternator	7.5 A
6		Headlight washer	20 A
7		Air conditioning	10 A
8		ETV/Oil cooler fan (Twin Clutch SST)	15 A
9		Security horn	20 A
10		Wiper deicer	15 A
11	—	—	—
12		Power gate	30 A
13		Daytime running lights	10 A
14		Headlight (high beam) (left)	10 A
15		Headlight (high beam) (right)	10 A
16		Headlight (low/high beam) (left)	20 A ^{*1}
17		Headlight (low/high beam) (right)	20 A ^{*1}

No.	Symbol	Electrical system	Capacity
18		Headlight (low beam) (left)	10 A ^{*2}
19		Headlight (low beam) (right)	10 A ^{*2}
20		ENG/POWER	10 A
21		Ignition coil	10 A
22		ENG/POWER	20 A
		Fuel line heater	25 A
23		Fuel pump	15 A
24		Starter	30 A ^{*3}
25		Valve lift control	40 A ^{*3}
26		Anti-lock braking system	40 A ^{*3}
27		Anti-lock braking system	30 A ^{*3}
28		Air conditioning condenser fan motor	30 A ^{*3}
29		Radiator fan motor	40 A ^{*3}
30		IOD	30 A
31		Audio amplifier	30 A
32		Diesel	30 A
33	—	Spare fuse	10 A

No.	Symbol	Electrical system	Capacity
34	—	Spare fuse	15 A
35	—	Spare fuse	20 A

*1- For vehicles equipped with high intensity discharge headlights

*2- For vehicles without high intensity discharge headlights

*3- Fusible link

● Some fuses may not be installed on your vehicle, depending on the vehicle model or specifications.

● The table above shows the main equipment corresponding to each fuse.

There are no 7.5 A, 25 A or 30 A spare fuses. If a fuse of one of these capacities blows, replace it temporarily by borrowing one of the fuses indicated below.

7.5 A: 10 A spare fuse

25 A: 20 A spare fuse

30 A: 30 A audio amplifier fuse

Replace the borrowed fuse with a fuse that has the correct capacity as soon as possible.

Fuses

Identification of fuse

Capacity	Color
7.5 A	Brown
10 A	Red
15 A	Blue
20 A	Yellow
25 A	Natural (White)
30 A	Green (fuse type)/Pink (fusible link type)
40 A	Green

9

Fuse replacement

N00954900085

1. Before replacing a fuse, always turn off the electrical item connected to the fuse and turn the ignition switch to the "LOCK" position.
2. There is a fuse puller (A) in the engine compartment fuse block.

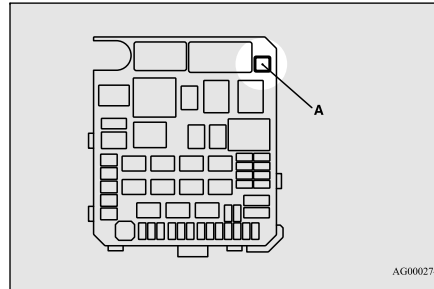

AG0002749

3. Clamp it on the fuse you wish to remove, and pull the fuse straight out from the fuse block.

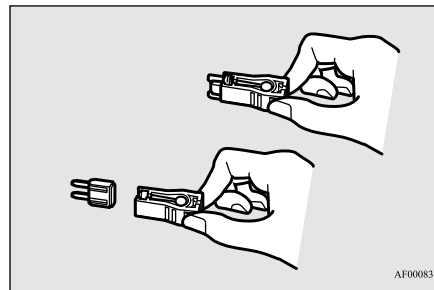

AF0008315

4. Use the fuse location diagrams and the matching tables, to check the fuse that is related to the problem. If the fuse is not blown, something else must be causing the problem. Contact an authorized Mitsubishi Motors dealer or a repair facility of your choice to have the problem checked.

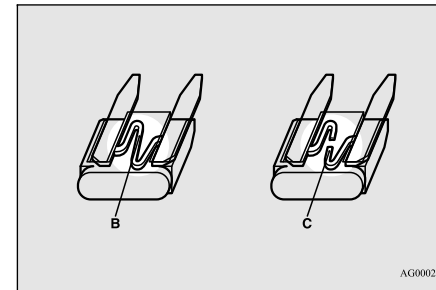

AG0002765

- B- Fuse is OK
- C- Blown fuse

5. Insert a new fuse of the same capacity securely into the appropriate slot.

CAUTION

- Never use a fuse with a capacity greater than the one listed or any substitute, such as wire, foil etc. This would cause the circuit wiring to heat up and could cause a fire.

Replacement of light bulbs

⚠ CAUTION

- If the replacement fuse blows again after a short time, have the electrical system checked by an authorized Mitsubishi Motors dealer or a repair facility of your choice to find and correct the cause.

Replacement of light bulbs

N00942900219

Before replacing a bulb, be sure the light is off. Do not touch the glass part of the new bulb with your bare fingers; the oil from your skin will stay on the glass and dim or destroy the bulb when it gets hot.

⚠ CAUTION

- Bulbs are extremely hot immediately after being turned off. When replacing a bulb, wait for it to cool sufficiently before touching it. You could otherwise be burned.

📖 NOTE

- If you are unsure of how to carry out the work as required, it is recommended that these procedures be carried out by an authorized Mitsubishi Motors dealer or a repair facility of your choice.
- Be careful not to scratch the vehicle body when removing a light and lens.

📖 NOTE

- When it rains, or when the vehicle has been washed, the inside of the lens sometimes becomes temporarily foggy. This is the same phenomenon as when window glass mists up on a humid day, and does not indicate a functional problem. When the light is switched on, the heat will remove the fog. However, if water gathers inside the light, please have it checked by an authorized Mitsubishi Motors dealer or a repair facility of your choice.

Bulb capacity

N00943000158

The bulb should only be replaced with a new bulb with the same rating and type. The type and rating are listed on the base of the bulb.

Outside

N00950302001

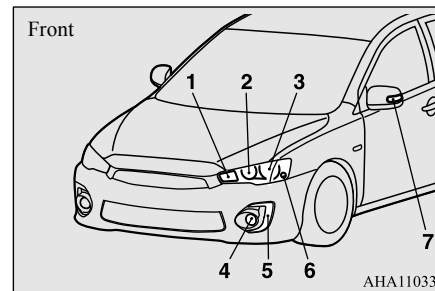

Description	Wattage	ANSI Trade No. or Bulb type
1- Front turn signal light	21 W	WY21W
2- Headlight, high beam	60 W	9005 HB3
3- Headlight, low beam (Halogen bulb)/ Daytime running light (Type 2)	51 W	9006 HB4
4- Front fog light (if so equipped)	19 W	H16
5- Parking light (Type 1)/ Daytime running light (Type 1) (if so equipped)	—	—
6- Front side-marker light/ Parking light (Type 2) (if so equipped)	5 W	WY5W
7- Side turn signal light	—	—

Replacement of light bulbs

⚠ WARNING

● Check with an authorized Mitsubishi Motors dealer or a repair facility of your choice when it is necessary to repair a discharge headlight or to replace the bulb. The power circuit, bulb and electrodes generate high voltages that may cause a severe electrical shock.

📖 NOTE

● The side turn signal light, front side-marker and parking light (Type 1) and daytime running light (Type 1) uses LEDs rather than bulbs.
For repair and replacement, contact an authorized Mitsubishi Motors dealer or a repair facility of your choice.

9

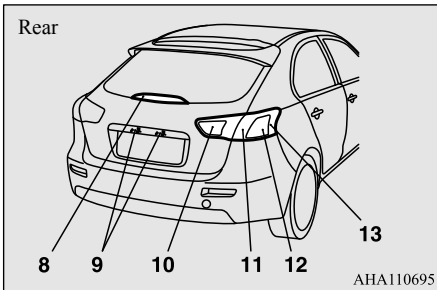

Description	Wattage	ANSI Trade No. or Bulb type
8- High-mounted stop light	—	—
9- License plate light	5 W	W5W
10- Back-up light	18 W	W16W
11- Tail and stop light	21/5 W	W21/5W
12- Rear turn signal light	21 W	WY21W
13- Rear side-marker light	5 W	W5W

📖 NOTE

● The high-mounted stop light uses LEDs rather than bulbs. For repair and replacement, contact an authorized Mitsubishi Motors dealer or a repair facility of your choice.

Inside

N00950401698

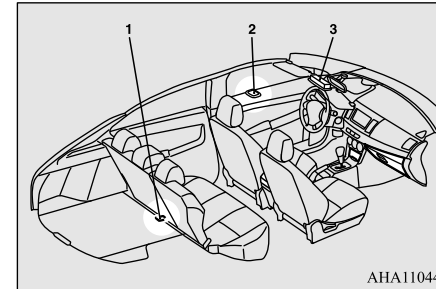

Description	Wattage
1- Cargo room light	8 W
2- Dome light (rear) (if so equipped)	8 W
3- Dome light (front)/Reading light	8 W

Headlights (low beam)

N00901801160

1. Turn the bulb (A) counterclockwise, and then remove the headlight bulb with holder.

Replacement of light bulbs

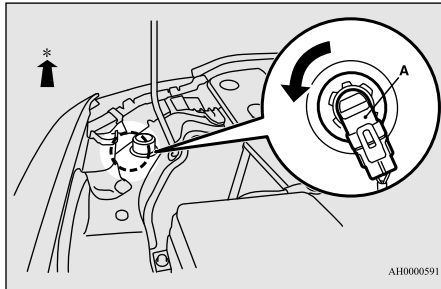

*- Front of the vehicle

2. While holding down the tab (B), pull out the bulb (C).

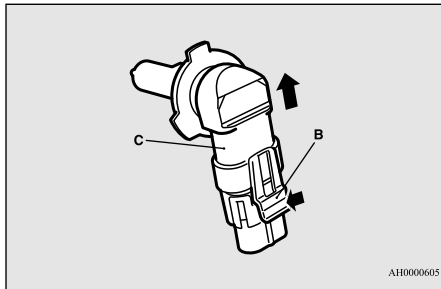

3. To install the bulb, perform the removal steps in reverse.

CAUTION

- Handle halogen light bulb with care. The gas inside a halogen light bulb is highly pressurized, so dropping, knocking, or scratching a halogen light bulb can cause it to shatter.
- Never hold the halogen light bulb with a bare hand, dirty glove, etc. The oil from your hand could cause the bulb to break the next time the headlights are used. If the glass surface is dirty, clean it with alcohol and let it dry completely before installing the bulb.

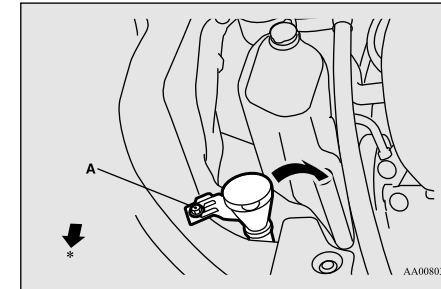
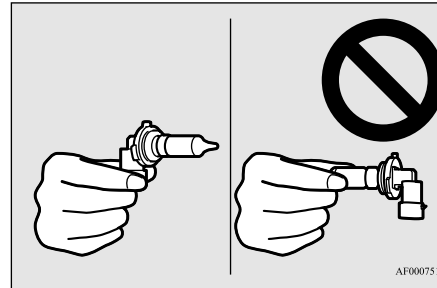

*- Front of the vehicle

2. Turn the cap (B) counterclockwise to remove it.

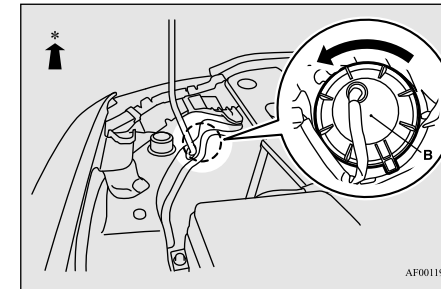

*- Front of the vehicle

3. Turn the bulb (C) counterclockwise to remove it.

Headlights (high beam)

N00901901129

1. When replacing the bulb on the front passenger's side, remove the bolt (A) holding down the washer tank spout and move the spout toward the rear of the vehicle.

Replacement of light bulbs

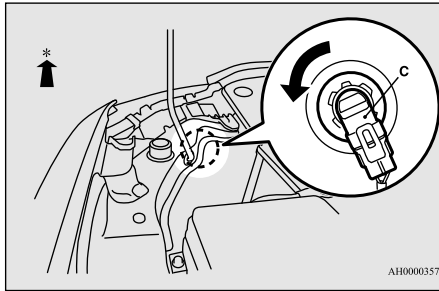

*- Front of the vehicle

9

4. While holding down the tab (D), pull out the bulb (E).

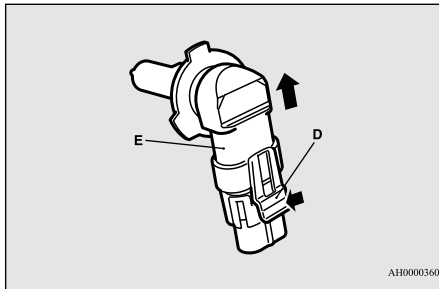

5. To install the bulb, perform the removal steps in reverse.

CAUTION

- Handle halogen light bulb with care. The gas inside a halogen light bulb is highly pressurized, so dropping, knocking, or scratching a halogen light bulb can cause it to shatter.
- Never hold the halogen light bulb with a bare hand, dirty glove, etc. The oil from your hand could cause the bulb to break the next time the headlights are used. If the glass surface is dirty, clean it with alcohol and let it dry completely before installing the bulb.

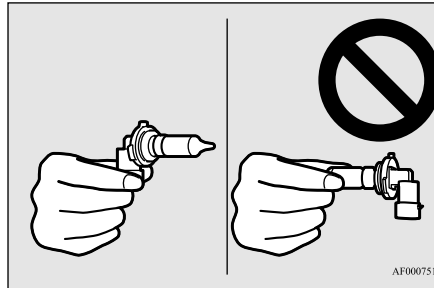

Adjustment of headlight aim

N00943200121

The alignment of the headlights should be checked by an authorized Mitsubishi Motors dealer or a repair facility of your choice.

Front side-marker lights/parking lights (Type 2) (if so equipped)

N00917301636

1. Turn the socket (A) counterclockwise to remove it.

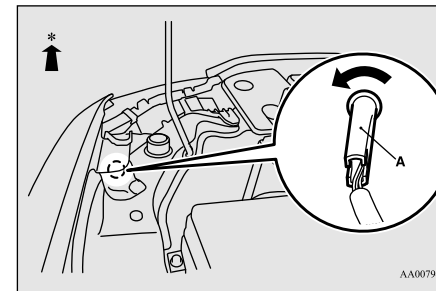

*- Front of the vehicle

2. Pull the bulb out of the socket.

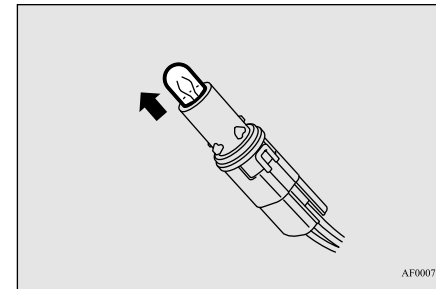

3. To install the bulb, perform the removal steps in reverse.

Front turn signal lights

N00943401410

1. Remove the clips (A) and clips (B), then remove the duct (C) and the upper cover (D).

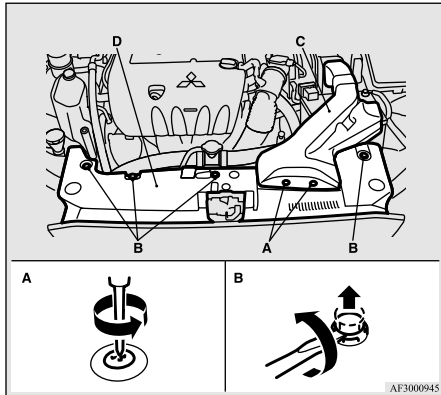

2. Remove the entire socket and bulb assembly (E) by turning it counterclockwise.

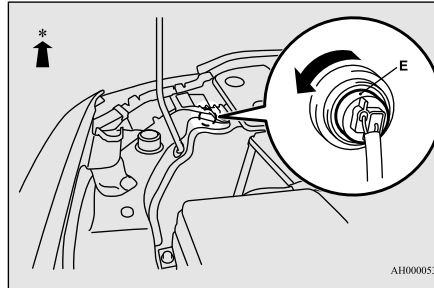

*- Front of the vehicle

3. Remove the bulb by pulling it out.

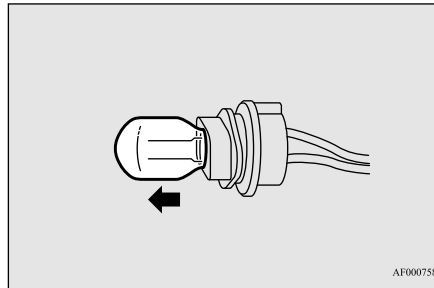

4. To install the bulb, perform the removal steps in reverse.

Replacement of light bulbs

Front fog lights (if so equipped)

N00943601861

1. On vehicles with the parking lights on bumper/daytime running lights on bumper, pull the light cover (A) out in the direction of the arrow shown in the illustration to disconnect the hooks (B).

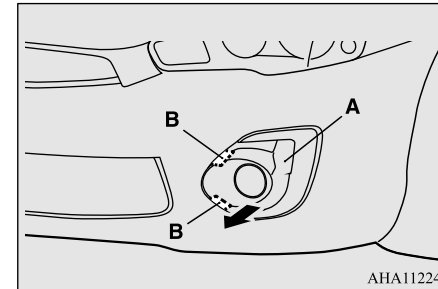

9

Replacement of light bulbs

2. Insert a straight blade (or minus) screwdriver with a cloth over its tip into the light cover (A) and pry gently to remove it.

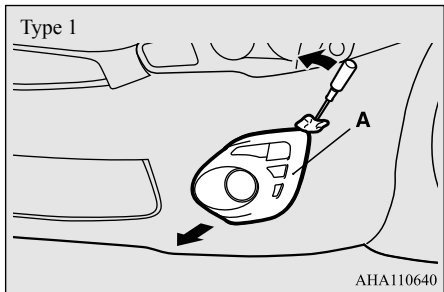

9

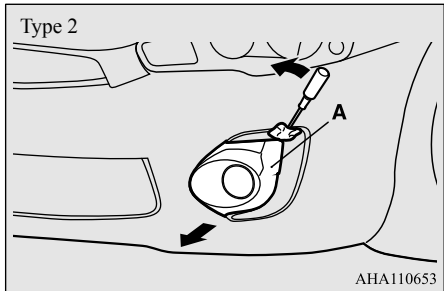

3. Remove the screws (C) and remove the light unit.

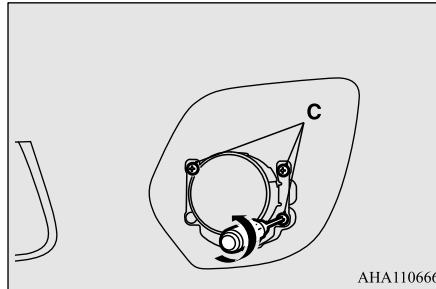

NOTE

- When unfastening the screws, be careful not to move the beam position adjustment screw (D).

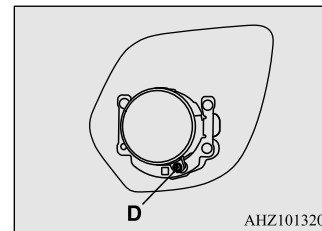

4. While holding down the tab (E), pull out the socket (F).

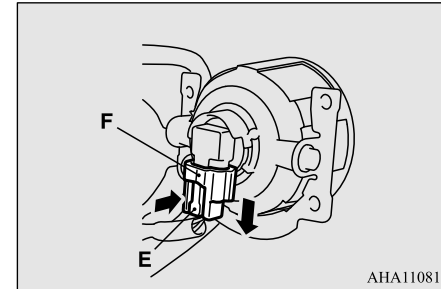

5. Turn the bulb (G) counterclockwise to remove it.

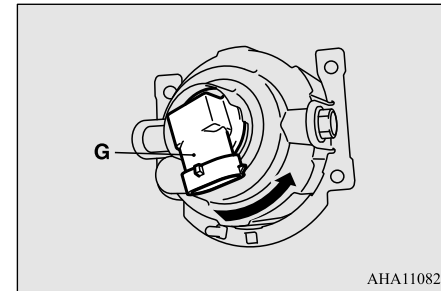

6. To install the bulb, perform the removal steps in reverse.

CAUTION

- Handle halogen light bulb with care. The gas inside a halogen light bulb is highly pressurized, so dropping, knocking, or scratching a halogen light bulb can cause it to shatter.
- Never hold the halogen light bulb with a bare hand, dirty glove, etc. The oil from your hand could cause the bulb to break the next time the fog lights are used. If the glass surface is dirty, clean it with alcohol and let it dry completely before installing the bulb.

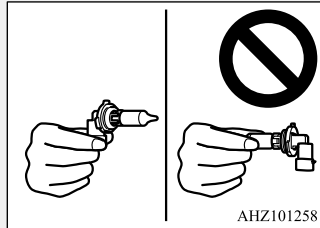

Rear combination lights

N00943701527

Tail and stop lights, rear turn signal lights and rear side-marker lights

1. Insert a screwdriver at the edge of the cover and pry gently to remove the cover.

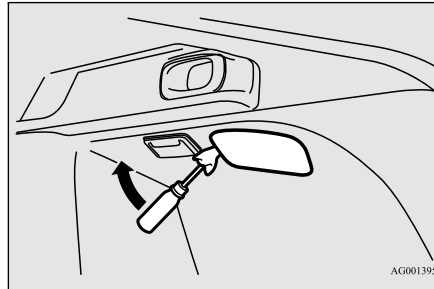

NOTE

- Wrap a cloth around the tip of the screwdriver to keep from scratching the cover.

2. Remove the socket and bulb assemblies by turning them counterclockwise.

Replacement of light bulbs

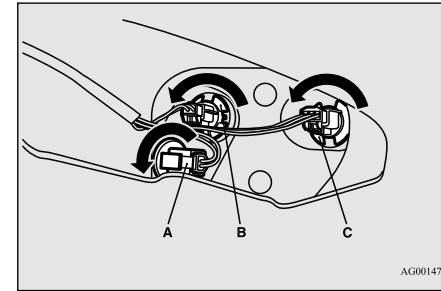

- A- Rear side-marker light
- B- Rear turn signal light
- C- Tail and stop light

3. Remove the bulb by pulling it out.

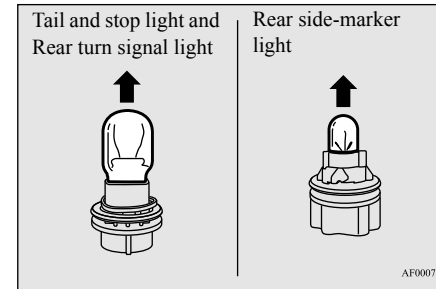

4. To install the bulb, perform the removal steps in reverse.

Replacement of light bulbs

NOTE

- When installing the cover, make sure the arrow on the cover is pointing in the direction of the front of the vehicle.

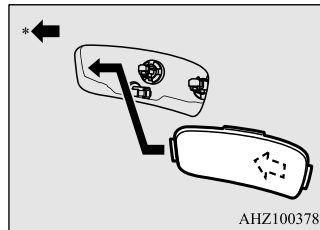

*- Front of the vehicle

9

Back-up lights

N0090120066

1. Insert a screwdriver into the notch of the cover and pry gently to remove the cover.

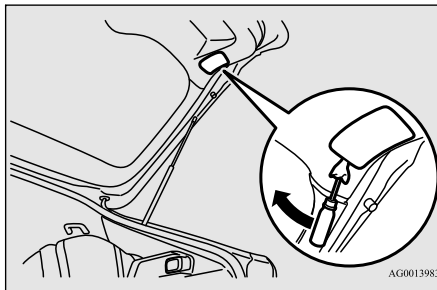

NOTE

- Wrap a cloth around the tip of the screwdriver to keep from scratching the cover.

2. Remove the socket and bulb assembly by turning it counterclockwise.

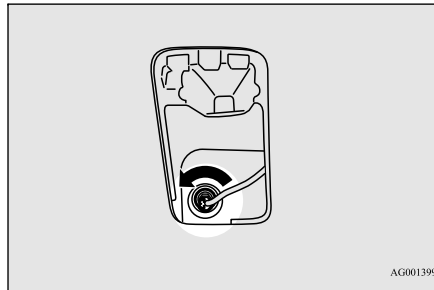

3. Remove the bulb by pulling it out.

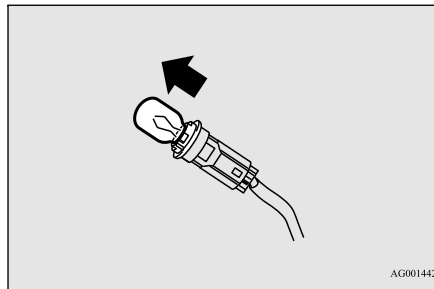

4. To install the bulb, perform the removal steps in reverse.

NOTE

- When installing the lid, align the tab on the lid with the hole on the vehicle side.

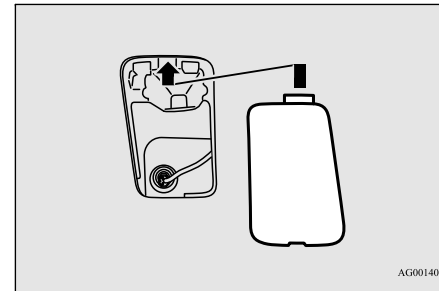

License plate lights

N0094400357

1. When removing the light unit (A), push it toward the left side of the vehicle body.

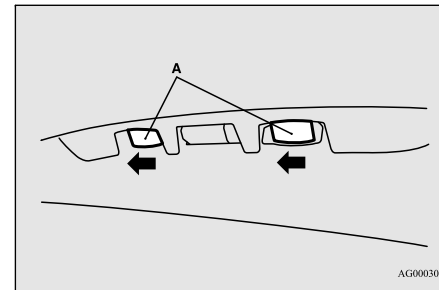

2. Use a screwdriver to gently pry up the tab (B) and remove the lens.

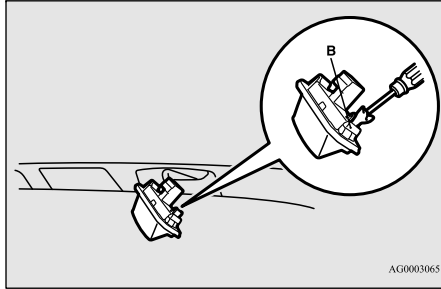

NOTE

- Wrap a piece of cloth around the tip of the screwdriver to keep from scratching the lens.

3. Pull the bulb out of the socket.

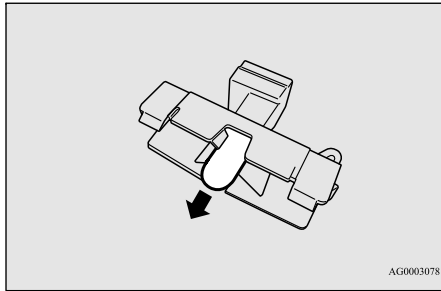

4. To install the bulb, perform the removal steps in reverse.

NOTE

- When installing the light, insert tab (C) first then align and insert tab (D).

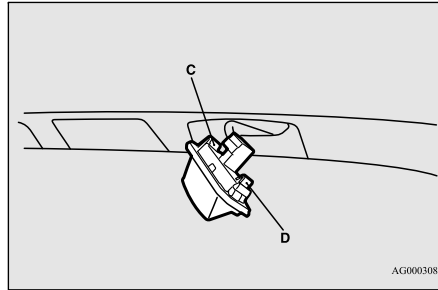

Replacement of light bulbs

Dome light (front)/Reading lights

N00944500235

1. Insert a screwdriver into the notch of the light assembly. Gently pry to remove the lens.

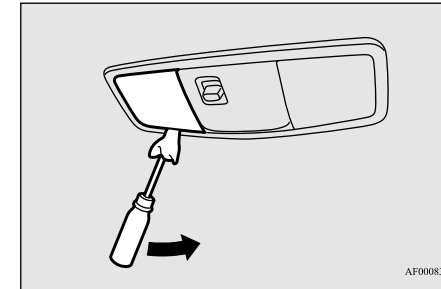

NOTE

- Wrap a cloth around the tip of the screwdriver to keep from scratching the lens.

Replacement of light bulbs

2. While holding down the tab (A), pull out the bulb.

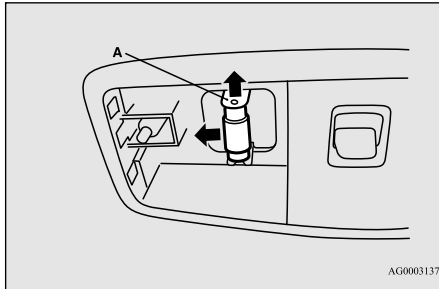

3. To install the bulb, perform the removal steps in reverse.

NOTE

- Before replacing the bulb, put the dome light (front)/reading lights switch into the “OFF” position.
- When mounting the lens, align the tab (B) with the hole on the vehicle body.

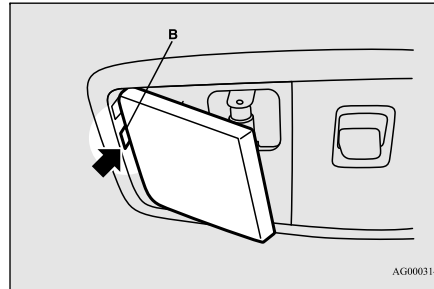

9

Dome light (rear) (if so equipped)

N00944100329

1. Insert a screwdriver into the notch of the light assembly and pry gently to remove the lens.

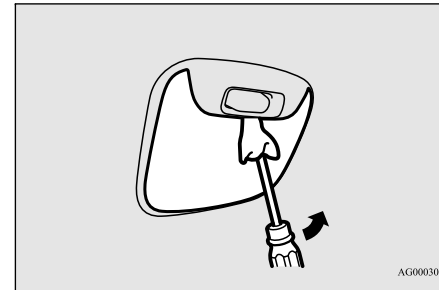

NOTE

- Wrap a cloth around the tip of the screwdriver to keep from scratching the lens.

2. While holding down the tab (A), pull out the bulb.

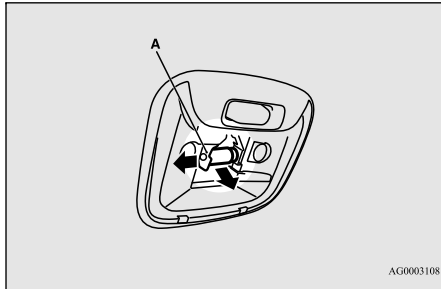

3. To install the bulb, perform the removal steps in reverse.

NOTE

- Before replacing the bulb, put the dome light (rear) switch into the "OFF" position.
- When mounting the lens, align the tabs (B) with the holes on the vehicle body.

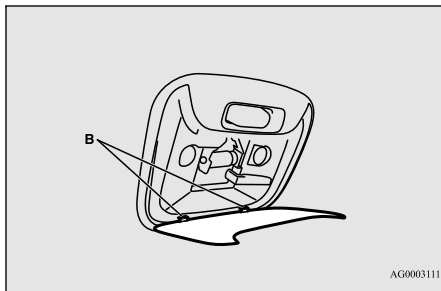

Cargo room light

N0095000075

1. Insert a screwdriver into the notch of the light assembly and pry gently to remove the lens.

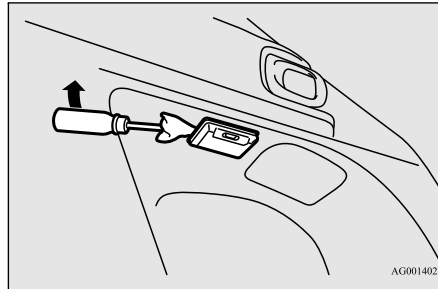

NOTE

- Wrap a cloth around the tip of the screwdriver to keep from scratching the lens.

2. Remove the bulb by pulling it out.

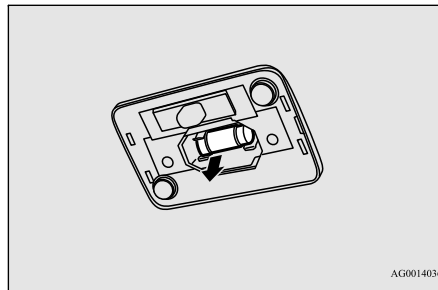

Vehicle care precautions

3. To install the bulb, perform the removal steps in reverse.

NOTE

- Before replacing the bulb, put the cargo room light switch into the "OFF" position.

Vehicle care precautions

N00945100179

In order to maintain the value of your vehicle, perform regular maintenance using the proper materials and procedures. Be sure to use only those materials and procedures that meet your local environmental pollution control regulations. Choose the materials you will use carefully, to be sure that they do not contain corrosives. If you are not sure, contact an authorized Mitsubishi Motors dealer for help in choosing these materials.

CAUTION

- Cleaning products can be dangerous. Some are poisonous. Others are highly flammable. Some are dangerous if you breathe their fumes in a closed space. When you use anything in a container to clean your vehicle, be sure to follow the instructions. Always open your vehicle doors or windows when you're cleaning the inside. Never use the following chemicals to clean your vehicle:
 - Gasoline

Cleaning the inside of your vehicle

CAUTION

- Carbon Tetrachloride
- Benzine
- Kerosene
- Naphtha
- Acetone
- Turpentine
- Paint Thinner
- Lacquer Thinner
- Nail Polish Remover

These can all be dangerous, and they all can damage your vehicle.

9

Cleaning the inside of your vehicle

N00945200109

After washing the inside of your vehicle with any cleaner, wipe it dry in a shady, well ventilated area.

CAUTION

- Do not use organic substances (solvents, benzine, kerosene, alcohol, gasoline, etc.) or alkaline or acidic solutions. These chemicals can cause discoloring, staining or cracking of the surface. If you use cleaners or polishing agents, make sure their ingredients do not include the substances mentioned above.

NOTE

- Always read the instructions on the cleaner label.

Plastic, vinyl leather, fabric and flocked parts

N00945300168

1. Lightly wipe these off with a soft cloth soaked in a 3 % solution of gentle soap and water.
2. Dip cloth in fresh water and wring out well. Using this cloth, wipe off the detergent thoroughly.

NOTE

- Do not use cleaners, conditioners, and protectants containing silicones or wax. Such products, when applied to the instrument panels or other parts, may cause reflections on the windshield and obscure vision. Also, if such products get on the switches of the electrical accessories, it may lead to failure of these accessories.

Upholstery

N00945500131

1. To maintain the value of your new vehicle, maintain the upholstery carefully and keep the interior clean.

Use a vacuum cleaner and brush to clean the seats. If stained, vinyl and synthetic leather should be cleaned with an appropriate cleaner. Cloth fabrics can be cleaned with either upholstery cleaner or a 3 % solution of gentle soap in lukewarm water.

2. Clean the carpeting with a vacuum cleaner and remove any stains with carpet cleaner. Oil and grease can be removed by lightly dabbing with a clean white cloth and spot remover.

NOTE

- If fuzzing is difficult to remove from the seat upholstery, draw a suitable defuzzing brush over the surface in one direction.

Genuine leather (if so equipped)

N00945600233

1. To clean, lightly wipe the leather with a soft cloth soaked in a 5 % solution of gentle soap and water.
2. To rinse, dip the cloth in fresh water, wring it out well, and wipe off all the soap.
3. To preserve and protect, use a leather protecting agent on the genuine leather surface.

NOTE

- If genuine leather is wet with water, wipe it with a dry, soft cloth. If left damp, mildew may grow.
- The genuine leather surface can be damaged if brushed with a nylon or synthetic fiber brush.
- Organic solvents such as benzine, kerosene, alcohol, gasoline, acid or alkaline solvents can discolor the genuine leather surface and should not be used.
- Genuine leather can mildew if not kept clean. Clean up any oil stains immediately.
- The genuine leather surface may harden and shrink if it is exposed to the direct sunlight for long hours. When your vehicle is parked, place it in the shade as much as possible.
- When the temperature of the vehicle interior rises in summer, vinyl products left on the genuine leather seat may deteriorate and stick to the seat.

Cleaning the outside of your vehicle

N00945700061

To protect your vehicle's finish, wash it often and thoroughly. If desired, you may wax your vehicle using a nonabrasive automobile wax.

Foreign material

N00945800046

Industrial pollution, road tar, bird droppings, tree sap, insect remains, sea water and other foreign matters can damage the finish on your vehicle.

Generally, the longer any foreign material stays on the finish, the worse the damage. Wash your vehicle as soon as possible whenever the finish gets soiled.

Washing

N00945901640

Chemicals contained in the dirt and dust picked up from air, rain, snow or road surfaces can damage the paint and body of your vehicle if left on.

Frequent washing and waxing is the best way to protect your vehicle from this damage.

Do not wash the vehicle in direct sunlight. Park the vehicle in the shade and spray it with water to remove dust. Next, using plenty of clean water and a car washing mitt or sponge, wash the vehicle from top to bottom.

Use a mild car washing soap if necessary. Rinse thoroughly and wipe dry with a cham-
ois or soft cloth. After washing the vehicle, carefully clean the joints and flanges of the doors, hood, etc., where dirt is likely to remain.

Cleaning the outside of your vehicle**CAUTION**

- When washing the underside of your vehicle or the wheels, wear a pair of gloves to protect your hands.
- Never spray or splash water on the electrical parts in the engine compartment. This may damage them. Be careful also when washing the underbody. Do not spray water into the engine compartment.
- Avoid automatic car washers that use rotating brushes. These brushes may scratch the paint surface and make it dull. Scratches are more noticeable on darker colored vehicles.
- Some hot water washing equipment uses high pressure and heat to clean your vehicle. This heated water may damage your vehicle's resin parts. It can flood the interior of the vehicle. Therefore, be sure of the following:
 - Keep the washing nozzle at least 20 inches (50 cm) away from the vehicle body.
 - When washing around the door glass, hold the nozzle at a distance of more than 20 inches (50 cm) and at right angles to the glass surface.
- When using high-pressure water to wash a vehicle equipped with the F.A.S.T.-key system, keep the water from spraying on the open button on the rear hatch. This could cause the rear hatch to open and flood the inside of the rear hatch.

Cleaning the outside of your vehicle

⚠ CAUTION

- Make sure to do the following when using an automatic car wash, with help from either this manual or the car wash operator, to avoid damaging your vehicle:
 - Fold the outside rear-view mirrors.
 - Put down (except for vehicles equipped with SIRIUS satellite radio antenna only) or remove the antenna.
 - If your vehicle is equipped with rear spoiler, check with the car wash operator before using the car wash.

📖 NOTE

- When the door is frozen, opening it by force may tear off or crack the rubber gasket installed around the door. Pour warm water to melt the ice. Be sure to thoroughly wipe off the water after opening the door. To prevent freezing of the weatherstripping on the doors, hood, etc., treat with silicone lubricant.

⚠ CAUTION

- Do not use gasoline, kerosene, benzine or paint thinners to remove road tar or other dirt from the vehicle surface.
- Do not put wax on the areas having black matte coating because it can cause uneven discoloration, patches, blurs, etc. If these get wax on them, wipe the wax off right away with a soft cloth and warm water.
- On vehicles equipped with sunroof, be careful not to apply any wax on the weatherstrip (black rubber) when waxing the area around the sunroof opening.
If stained with wax, the weatherstrip cannot maintain a weatherproof seal with the sunroof.

9

During cold weather

Salt and other chemicals spread on winter roads in some geographical areas can have a detrimental effect on the vehicle underbody. You should flush the underbody with a high pressure hose every time you wash the outside of your vehicle.

Take special care to remove mud or other debris which could trap and hold salt and moisture.

After washing your vehicle, wipe off all waterdrops from the rubber parts around the doors to prevent the doors from freezing.

Waxing

N00946000218

Wax your vehicle once or twice a year, or when water does not bead up on the paint.

Use a soft cloth to put a small amount of wax on the painted surfaces. After the wax has dried, polish with a dry soft cloth.

Do not wax your vehicle in direct sunlight.

You should wax when the painted surfaces are cool.

⚠ CAUTION

- Waxes containing high abrasive compounds should not be used. These waxes remove rust and stain effectively from the paintwork, but are harmful to the finish on the paint and the plate, because they also remove clearcoat. They are also harmful to other glossy surfaces such as the grille, trim, moldings, etc.

Polishing

N00946100059

If painted surfaces have been severely damaged and lost their original luster and color tone, polish the surface lightly with a fine polishing compound. Avoid limiting your polishing to the damaged surface only; polish a somewhat wider area, moving the polishing cloth in one direction. After polishing, flush the compound from the surface and apply a coat of wax to regain a beautiful luster.

Cleaning the outside of your vehicle

Damaged paint

N00946200063

Small cracks and scratches in the paint coat should be touched up as soon as possible with touch-up paint to prevent corrosion. Check body areas facing the road or the tires carefully for damage to the paint caused by flying stones, etc. The paint code number for your vehicle can be found on the vehicle information code plate in the engine compartment.

Cleaning plastic parts

N00946300178

Use a sponge or chamois to clean these parts. If a vehicle wax sticks to a gray or black rough surface of the bumper, molding or lights, the surface may appear white in color. In this case, wipe it off using lukewarm water and a soft cloth or chamois.

CAUTION

- Do not use a scrubbing brush or other rough scrubber as these may damage the plastic surface.
- Do not use wax containing compounds (polishing powder) which may damage the plastic surface.

CAUTION

- Do not let the plastic parts get soiled with gasoline, oil, brake fluids, engine oils, greases, paint thinner, and sulfuric acid (battery electrolyte). These fluids, etc., may crack, stain or discolor the plastic parts. If any of these get on the plastic parts, wipe them up with a soft cloth or chamois and a mild solution of soap and water. Then rinse them immediately with water.

Chrome parts

N00946400065

To prevent spots and corrosion of chrome parts, wash with water, dry thoroughly, and apply a nonabrasive automotive wax. If the chrome is severely damaged or pitted, use a commercially available chrome polish.

Aluminum wheels

N00946500109

1. Remove dirt using a wet sponge.
2. Use a mild detergent on any dirt that cannot be removed easily with water. Rinse off the detergent after washing the wheel.
3. Dry the wheel thoroughly using a chamois leather or a soft cloth.

CAUTION

- Do not use a brush or other hard implement on the wheels. Doing so could scratch the wheels.
- Do not use any cleaner that contains an abrasive substance or is acidic or alkaline. Doing so could cause the coating on the wheels to peel or become discolored or stained.
- Do not directly apply hot water using a steam cleaner or by any other means.
- Contact with seawater or road salt used for de-icing can cause corrosion. Rinse off such substances as soon as possible.

Window glass

N00946600067

The window glass can usually be cleaned using only a sponge and water. Glass cleaner can be used to remove wax, oil, grease, dead insects, etc. After washing the glass, wipe it dry with a clean, dry, soft cloth.

Wiper blades

N00946700097

Use a soft cloth and glass cleaner to remove grease, dead insects, etc., from the wiper blades.

Replace the wiper blades when they no longer clean the windshield and rear window properly.

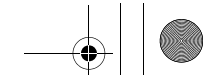

Cleaning the outside of your vehicle

Cleaning the sunroof (if so equipped)

N0094680072

Clean the inside of the sunroof with a soft cloth. Hard deposits should be wiped away with a cloth dipped in warm, neutral detergent solution. Wipe away the solution with a sponge dipped in fresh water.

NOTE

- The surface treatment on the inside of the glass may be removed if a hard cloth or organic solvent is used.

9

Engine compartment

N0094700042

Never spray or splash water on the electrical components in the engine compartment, as this may cause damage.

Do not allow any nearby parts (such as plastic parts) come into contact with sulphuric acid (battery electrolyte), which may crack, stain, or discolour them.

If this occurs, wipe the parts with a soft cloth saturated with a mild detergent and water solution.

Then immediately rinse the affected parts with plenty of water.

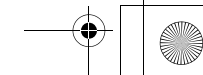
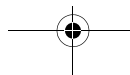

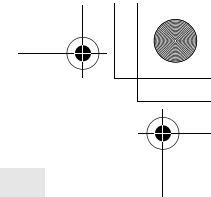

Customer assistance/Reporting Safety Defects

Consumer information (For vehicles sold in U.S.A.)	10-2
Reporting Safety Defects	10-2
Important facts to know in case of an accident	10-4

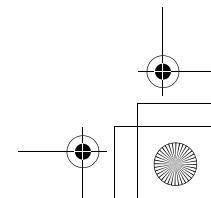
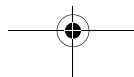
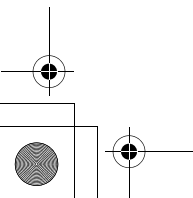
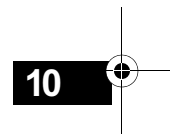
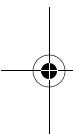



Consumer information (For vehicles sold in U.S.A.)

Consumer information (For vehicles sold in U.S.A.)

N01047100100

This information is provided in compliance with the requirements of the National Highway Traffic Safety Administration, Department of Transportation. It provides the purchasers and/or prospective purchasers with information on reporting safety defects.

Uniform tire quality grading

DOT quality grades - All passenger vehicle tires must conform to Federal Safety Requirements in addition to these grades. The specific grade rating in each grade category is shown on the side wall of the tires on your vehicle.

10

Treadwear

The treadwear grade is a comparative rating based on the wear rate of the tire when tested under controlled conditions on a specified government test course. For example, a tire graded 150 would wear one and one-half (1¹/₂) times as well on the government course as a tire graded 100. The relative performance of tires depends upon the actual conditions of

their use, however, and may depart significantly from the norm due to variations in driving habits, service practices and differences in road characteristics and climate.

Traction AA, A, B, C

The traction grades, from highest to lowest, are AA, A, B and C. Those grades represent the tire's ability to stop on wet pavement as measured under controlled conditions on specified government test surfaces of asphalt and concrete. A tire marked C may have poor traction performance.

WARNING

- The traction grade assigned to this tire is based on straight-ahead braking traction tests, and does not include acceleration, cornering, hydroplaning, or peak traction characteristics.

Temperature A, B, C

The temperature grades are A (the highest), B and C, representing the tire's resistance to the generation of heat and its ability to dissipate heat when tested under controlled conditions on a specified indoor laboratory test wheel. Sustained high temperature can cause the

material of the tire to degenerate and reduce tire life, and excessive temperature can lead to sudden tire failure. The grade C corresponds to a level of performance which all passenger car tires must meet under the Federal Motor Vehicle Safety Standard No. 109. Grades B and A represent higher levels of performance on the laboratory test wheel than the minimum required by law.

WARNING

- The temperature grade for this tire is established for a tire that is properly inflated and not overloaded. Excessive speed, underinflation, or excessive loading, either separately or in combination, can cause heat buildup and possible tire failure.

Reporting Safety Defects

N01047201485

If you believe that your vehicle has a defect which could cause a crash or could cause injury or death, you should immediately inform the National Highway Traffic Safety Administration (NHTSA) in addition to notifying Mitsubishi Motors Corporation.

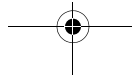

Reporting Safety Defects

If NHTSA receives similar complaints, it may open an investigation, and if it finds that a safety defect exists in a group of vehicles, it may order a recall and remedy campaign. However, NHTSA cannot become involved in individual problems between you, your dealer, or Mitsubishi Motors Corporation.

To contact NHTSA, you may call the Vehicle Safety Hotline toll-free at 1-888-327-4236 (TTY: 1-800-424-9153); go to <http://www.safercar.gov>; or write to:

NHTSA Headquarters
1200 New Jersey Avenue, SE
West Building
Washington, DC 20590

You can also obtain other information about motor vehicle safety from <http://www.safercar.gov>.

For vehicles sold in U.S.A.

To contact Mitsubishi Motors North America, Inc. call 1-888-648-7820 or write to:

Mitsubishi Motors North America, Inc.
Customer Relations Department
P.O. Box 6400
Cypress, CA 90630-0064

For vehicles sold in Canada

If you live in Canada, and you believe that your vehicle has a safety defect, you should immediately notify Transport Canada, in addition to notifying Mitsubishi Motor Sales of Canada, Inc. You may write to:

Transport Canada
330 Sparks Street
Tower C
Ottawa, Ontario K1A 0N5

To contact Mitsubishi Motor Sales of Canada, Inc. call 1-888-576-4878 or write to:

Mitsubishi Motor Sales of Canada, Inc.
Customer Relations Department
P.O. Box 41009
4141 Dixie Road
Mississauga, ON L4W 5C9

For vehicles sold in Puerto Rico

To contact Mitsubishi Motor Sales of Caribbean, Inc. call 1-787-251-8715 or write to:

Mitsubishi Motor Sales of Caribbean, Inc.
Customer Service Department
P.O. Box 192216
SAN JUAN PR 00919-2216

For vehicles sold in Guam

To contact Triple J Enterprises Inc.

Important facts to know in case of an accident

call (671)649-3673 or write to:

Triple J Enterprises, Inc.
P.O. Box 6066
TAMUNING
GUAM 96931

Pacific Marketing, Inc.
P.O. Box 698
PAGO PAGO,
AMERICAN SAMOA AS,
96799

Key information to discuss with your insurance company

- Understand your repair estimate before approving repairs.
- Choosing the repair shop and the brands of parts that they use on your vehicle is your decision.
- Ask for genuine Mitsubishi Motors parts. Many times, to save money, your insurance company will recommend imitation parts that do not meet the original specifications of fit, finish, corrosion resistance or workmanship.

For vehicles sold in Saipan

To contact Triple J Motors
call (670)234-7133 or write to:

Triple J Motors
P.O. Box 500487
SAIPAN, MP96950-0487

Important facts to know in case of an accident

N01047300229

We hope you will never be involved in an accident, but there is always that potential danger. So, please be sure to buckle up and drive safely.

In the event of an accident

- Remain calm.
- Check for injuries. Report all injuries to the police, and, if necessary, call for an ambulance.
- Record all the details of the accident. This will provide you with accurate records of the accident for discussions with your insurance company and other persons who may be acting on your behalf.

Mitsubishi Motors built-in protection

The strength and integrity built into your Mitsubishi vehicle is the result of a specific design referred to as "Energy Management". Individual body parts are designed to act as one unit in the event of an accident. Shock waves are absorbed by protective panels or are channeled around the passenger compartment. This important feature is possible because high tensile steel is used in Mitsubishi Motors panels and structural parts, something that cannot be guaranteed by the manufacturers of imitation parts. All Genuine Mitsubishi Motors body panels and support

For vehicles sold in American Samoa

To contact Pacific Marketing Inc.
call 684(699)9140 or write to:

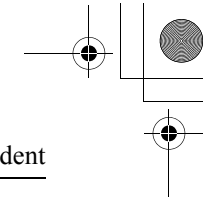

Important facts to know in case of an accident

brackets are designed and constructed as important protection features in the event of an accident. By replacing body parts with imitations, your vehicle may no longer meet original equipment specifications.

you expect. Genuine Mitsubishi Motors replacements parts are your guarantee that your vehicle will have all the technological advantages and maintain the style and protection of a brand new Mitsubishi Motors. Remember to ask for genuine Mitsubishi Motors parts.

Consumer rights (For vehicles sold in U.S.A.)

As a consumer requesting repair on your vehicle, you have consumer rights. Across the country, State Insurance Commissioners have begun considering rules on the use of non-OEM parts. This could mean that repair shops will have to disclose to the consumer, when they intend to use non-OEM parts. Since regulations are not consistent on this point, remember you have a choice. So, if you want genuine Mitsubishi Motors parts, you may have to specifically request them. Make certain your insurance company understands imitations are not to be used in the repair of your vehicle. You deserve the best genuine Mitsubishi Motors parts.

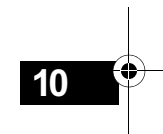
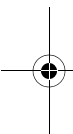

Genuine Mitsubishi Motors parts

Genuine Mitsubishi Motors parts are built with the high quality and durability standards

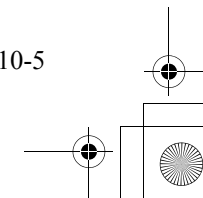
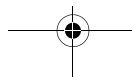
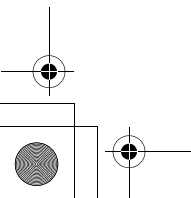

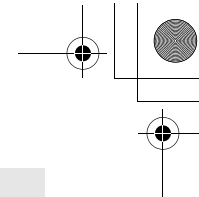

Specifications

Vehicle labeling	11-2
Vehicle dimensions	11-4
Vehicle weights	11-4
Engine specifications	11-5
Battery	11-5
Tires and wheels	11-5
Refill capacities	11-6

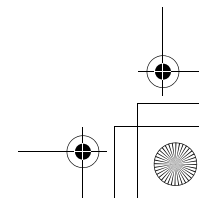
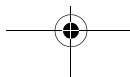
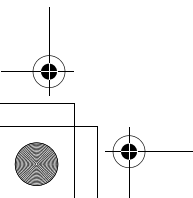
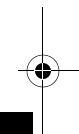
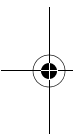

Vehicle labeling

Vehicle labeling

N01147401778

Keep a record of the chassis number and vehicle identification number. Such information will assist the police if your vehicle is stolen.

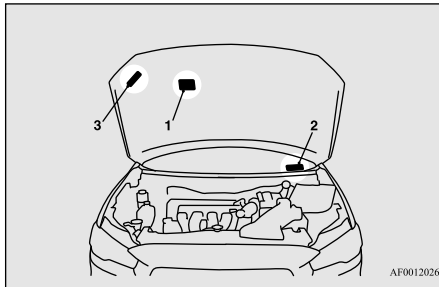

11

1 - Vehicle emission control information label

The vehicle emission control information label is affixed on the inside panel of the engine hood.

2 - Vehicle identification number plate

The vehicle identification number is stamped on the plate riveted to the left front corner of the vehicle body. It is visible from outside of the vehicle through the windshield.

3 - Air conditioning label

The air conditioning label is affixed on the inside panel of the engine compartment.

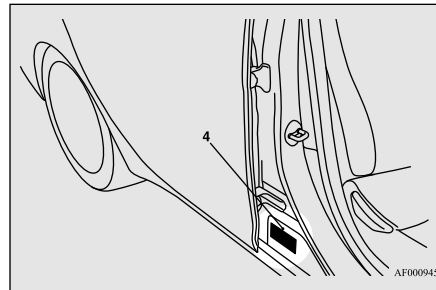

4 - Vehicle information code plate

The vehicle information code plate is located on the front passenger door sill.

Chassis number

The chassis number is stamped on the floor under the front passenger seat. It is visible by pulling back the carpet flap as shown in the illustration.

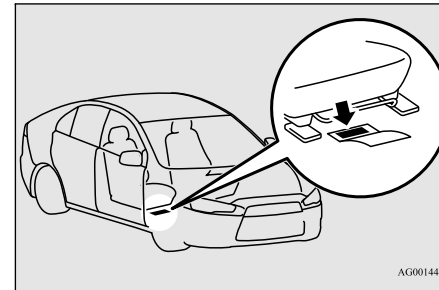

Engine serial number

The engine serial number is stamped on the cylinder block as shown in the illustration.

Vehicle labeling

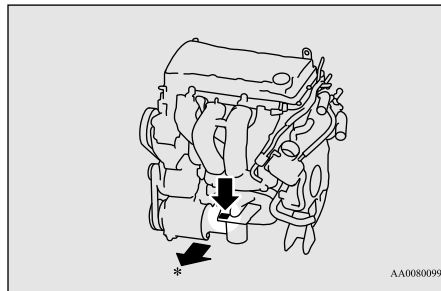

*- Front of the vehicle

Type 1

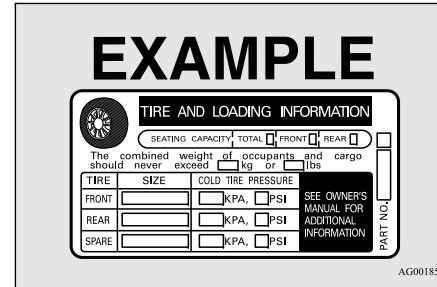

Certification label

N01148200226

The certification label (A) is located on the driver's door sill.

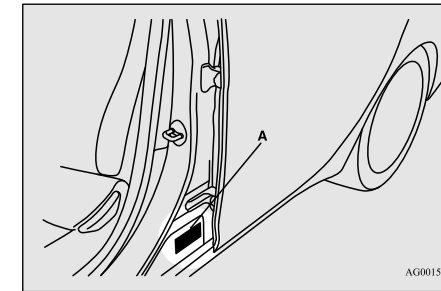

Tire and loading information placard

N01148100557

The tire and loading information placard is located on the driver's door sill.

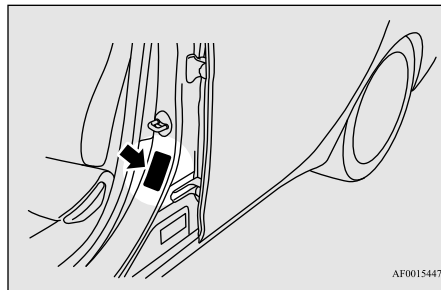

Type 2

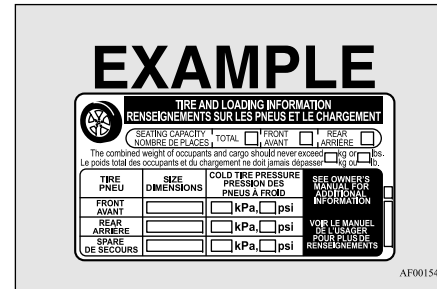

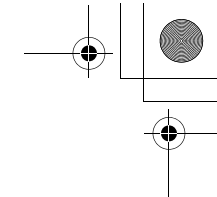
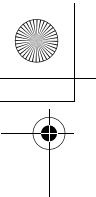

Vehicle dimensions

Vehicle dimensions

N01147501610

Overall length	182.7 in (4,640 mm)
Overall width	69.4 in (1,760 mm)
Overall height	59.3 in (1,505 mm)
Wheel base	103.7 in (2,635 mm)

Vehicle weights

N01147601930

Gross vehicle weight rating (GVWR)	4,013 lb (1,820 kg)	
Gross axle weight rating (GAWR)	Front	2,227 lb (1,010 kg)
	Rear	2,117 lb (960 kg)
Vehicle capacity weight	827 lb (375 kg)	
Maximum roof load	110 lb (50 kg)	
Seating capacity	5 persons	

11

NOTE

- Roof load is important because it affects the vehicle capacity weight. Refer to “Loading cargo on the roof” on page 6-10.

GVWR: maximum total weight (load) limit specified for the vehicle
 GAWR: maximum weight (load) limit specified for the front or rear axle
 Seating capacity: the number of maximum occupants

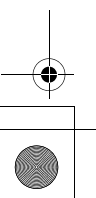

11-4 Specifications

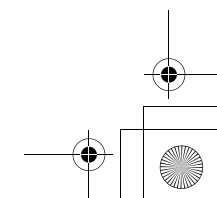
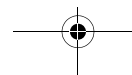

Engine specifications

Engine specifications

N01147701524

Engine model	4B11	
Engine displacement	121.9 CID (1,998 cm ³)	
No. of cylinders and cylinder arrangement	4 in-line	
Bore	3.39 in (86.0 mm)	
Stroke	3.39 in (86.0 mm)	
Compression ratio	10.0	
Thermostat valve opening temperature	189 °F (87.0 °C)	
Spark plugs	NGK	DIFR6C11
Spark plug gap	.040 to .043 in (1.0 to 1.1 mm)	
Firing order	1-3-4-2	

Battery

N01147800182

75D23L

Battery is a 12 volt type.

Tires and wheels

N01147901803

Tire	P205/60R16 91H
------	----------------

Wheel	Size	16 x 6 1/2J
	PCD	4.5 in (114.3 mm)
	Offset	1.81 in (46 mm)

PCD: Pitch Circle Diameter (installation holes)

NOTE

- Contact an authorized Mitsubishi Motors dealer for details on the combination used on your vehicle.
- These tires satisfy vehicle loading conditions described in this owner's manual.

Refill capacities

Refill capacities

N01148002185

Item		Capacity	Lubricants
Fuel (approximate)		15.5 gal (59.0 L)	Refer to "Fuel selection" on page 3-2.
Engine oil	Oil pan	4.2 qt (4.0 L)	Engine oils displaying the ILSAC certification mark ("starburst" symbol) on the container. If these oils are not available, an API classification SN or higher can be used.
	Oil filter	.32 qt (0.3 L)	
Manual transaxle		2.6 qt (2.5 L)	Mitsubishi Motors Genuine NEW MULTI GEAR OIL API classification GL-3 SAE 75W-80
Continuously variable transmission (CVT)		7.3 qt (6.9 L)	Refer to "Continuously variable transmission (CVT) fluid" on page 9-10.
Brake/Clutch (if so equipped)		As required	Conforming to Brake fluid DOT3 or DOT4
Hood lock release mechanism and safety catch		As required	Multipurpose type grease NLGI Grade 2
Engine coolant {includes .63 qt (0.65 L) in reserve tank}	Manual transaxle	7.4 qt (7.0 L)	Mitsubishi Motors Genuine Super Long Life Coolant Premium or equivalent*
	CVT	7.4 qt (7.0 L)	
Washer fluid		4.3 qt (4.0 L)	—
Refrigerant (air conditioning)		Refer to "Air conditioning label" on page 11-2.	HFC-134a

11

*: similar high quality ethylene glycol based non-silicate, non-amine, non-nitrate and non-borate coolant with long life hybrid organic acid technology

11-6 Specifications

Alphabetical index

A

Accessory (installation)	3-5
Active stability control (ASC)	5-69
Air cleaner filter	9-8
Air conditioning	
Automatic air conditioning	7-4
Important air conditioning operating tips..	7-9
Air purifier	7-9
Aluminum wheels	9-43
AM/FM radio	7-10
Antenna	
Roof antenna	7-46
Anti-lock braking system	5-66
Warning light / display	5-67
Arm rest	4-5
Assist grip	5-163
Audio	
AM/FM radio	7-10
CD player	7-10
Troubleshooting	7-44
Automatic air conditioning	7-4

B

Back-up lights	
Bulb capacity	9-29
replacement	9-36

Ball joint, steering linkage seals and drive shaft boots	9-23
Battery	9-11
Charging system warning light	5-118
Disconnection and connection	9-12
During cold weather	9-12
Specification	11-5
Bluetooth 2.0 interface	5-129
Bottle holder	5-161
Brake	
Anti-lock braking system	5-66
Braking	6-5
Fluid	9-10, 11-6
Hose	9-22
Parking brake	5-48
Parking brake lever stroke	9-20
Pedal	5-65
Pedal free play	9-20
Power brakes	5-65
Service brake	5-65
Brake assist	5-66
Break-in recommendations	5-3
Bulb capacity	9-29

C

California Perchlorate Materials Requirements	3-6
Capacities	11-6
Card holder	5-155, 5-159

Cargo floor boxes	5-160
Cargo loads	6-10
Cargo room light	
Bulb capacity	9-30
Replacement	9-39
Switch	5-158
Catalytic converter	9-2
CD player	7-10
Certification label	11-3
Charging system warning light	5-118
Chassis number	11-2
Child restraint	4-14
Child safety locks for rear door	5-38
Cleaning	
Inside of your vehicle	9-40
Outside of your vehicle	9-41
Clock	7-46
Clutch	
Fluid	9-10, 11-6
Pedal free play	9-20
Coat hooks	5-163
Combination headlights and dimmer switch .	5-120
Consumer information	10-2
Continuously variable transmission (CVT)...	5-58
Fluid	9-10, 11-6
Selector lever operation	5-58

Alphabetical index

Sports mode 5-62
 Coolant (engine)..... 9-7, 11-6
 Cruise control..... 5-72
 Cup holder 5-160

D

Daytime running lights
 Bulb capacity 9-29
 Defogger (rear window) 5-128
 Defrosting or defogging (windshield, door windows)..... 7-8
 Digital clock
 Time setting 7-42
 Dimensions 11-4
 Dimmer (high/low beam change) 5-122
 Disc brake pads 9-22
 Dome light (rear)
 Bulb capacity 9-30
 Replacement 9-38
 Switch 5-157
 Dome light/Reading lights
 Bulb capacity 9-30
 Replacement 9-37
 Switch 5-156
 Doors
 Lock..... 5-34
 Power door locks 5-37
 Driving during cold weather 6-4

Driving, alcohol and drugs 6-2
 Dual height adjustable cargo floor board 5-162

E

Electric power steering system (EPS) 5-69
 Electric rear window defogger switch.. 5-128
 Electronic immobilizer (Anti-theft starting system) 5-4, 5-27
 Electronic power steering system warning display 5-69
 Emission-control system maintenance ... 9-21
 Engine
 Compartment..... 9-5
 Coolant 9-7, 11-6
 Hood..... 9-3
 Oil and oil filter 9-5, 11-6
 Overheating..... 8-4
 Serial number 11-2
 Specifications 11-5
 Engine coolant temperature display..... 5-90
 EPS 5-69
 Exhaust system 9-23

F

Filling the fuel tank 3-3
 Floor console box..... 5-159
 Floor mat..... 6-2

Fluid..... 11-6
 Brake fluid..... 9-10, 11-6
 Clutch fluid..... 9-10, 11-6
 Continuously variable transmission (CVT) fluid 9-10, 11-6
 Engine coolant 9-7, 11-6
 Washer fluid 11-6
 Fluid capacities and lubricants 11-6
 Fog lights
 Bulb capacity 9-29
 Indicator 5-116
 Switch 5-125
 Free-hand advanced security transmitter (F.A.S.T.-key) 5-12
 Front console tray 5-159
 Front fog lights
 Replacement 9-33
 Front seats..... 4-3
 Front side-marker and parking light
 Bulb capacity 9-29
 Replacement 9-32
 Front turn signal lights
 Bulb capacity 9-29
 Replacement 9-33
 Fuel
 Fuel economy..... 6-2
 Fuel hoses..... 9-22
 Modification/alterations to the electrical or fuel systems 3-6
 Tank capacity 3-4, 11-6

Fuel Pump Shut-off System	8-14
Fuel selection	3-2
Fuses	9-24
Fusible links	9-24

G

General maintenance	9-22
General vehicle data	11-4
Genuine parts	3-6
Glove compartment	5-159

H

Hazard warning flasher switch	5-124
Hazard warning lights	5-116
Head restraints	4-5
Headlights	
Bulb capacity	9-29
Dimmer	5-122
Headlight flasher	5-122
Replacement	9-30, 9-31
Switch	5-120
High beam indicator	5-116
High-mounted stop light	9-29
Hood lock release mechanism and safety catch	9-23
Horn switch	5-129

I

If the vehicle breaks down	8-2
Ignition switch	5-16, 5-52
Important facts to know in case of an accident	
10-4	
Indicators	5-116
Information screen display	5-118
Inside day/night rearview mirror	5-49
Instrument cluster	5-82
Interior lights	5-156

J

Jack	8-5
Storage	8-5
Jump-starting the engine	8-2

K

Key reminder buzzer	5-36
Keyless entry system	5-7, 5-30
Keys	5-3

L

Labeling	11-2
License plate light	
Bulb capacity	9-29
Replacement	9-36

Alphabetical index

Link System	5-129
Loading information	6-6
Lubricants	11-6

M

Malfunction indicator	5-117
Manual transaxle	5-56
Oil	9-9, 11-6
Shift points (recommended speed)	5-57
Mirror	
Inside day/night rearview mirror	5-49
Outside rearview mirrors	5-50
Modification of your vehicle	3-5
Multi-information display	5-84

O

Oil	
Engine oil	9-5, 11-6
Manual transaxle oil	9-9, 11-6
Operation under adverse driving conditions ..	
8-12	
Outside rearview mirrors	5-50
Overheating	8-4

P

Parking	6-5
Parking brake	5-48

Alphabetical index

Parking brake break-in 9-20
 Parking brake lever stroke 9-20
 Polishing..... 9-42
 Power brakes..... 5-65
 Power door locks 5-37
 Power outlet..... 5-155
 Power windows 5-43
 Puncture (Tire changing)..... 8-6

R

Radiator cap 9-8
 Radio
 General information about your radio 7-47
 Rear hatch..... 5-38
 Inside rear hatch release 5-40
 Rear shelf panel..... 5-161
 Rear side-marker lights
 Bulb capacity 9-29
 Replacement 9-35
 Rear turn signal lights
 Bulb capacity 9-29
 Replacement 9-35
 Rear window defogger switch 5-128
 Rear-view camera 5-80
 Rearview mirror
 Inside 5-49
 Outside..... 5-50

12-4

Refrigerant (air conditioning) 11-6
 Replacement of light bulbs..... 9-29
 Replacing tires and wheels 9-17
 Reporting Safety Defects 10-2

S

Safe driving techniques..... 6-4
 Seat 4-2
 Arm rest 4-5
 Front seats 4-3
 Heated seats..... 4-4
 Rear seats 4-5
 Seats and restraint systems 4-2
 Seat belt 4-9
 Adjustable seat belt shoulder anchor . 4-12
 Child restraint 4-14
 Driver's seat belt reminder/warning... 4-11
 Force limiter..... 4-14
 Front passenger seat belt warning light..... 4-12
 Maintenance and inspection 4-21
 Pre-tensioner 4-13
 Seat belt extender..... 4-13
 Seat belt instructions 4-9
 Seat belt use during pregnancy 4-13
 Service brake 5-65
 Service precautions 9-2
 Snow tires 9-19
 Spark plugs..... 9-21

Steering
 Tilt lock lever..... 5-49
 Wheel lock..... 5-20, 5-53
 Storage spaces 5-158
 Sun roof..... 5-45
 Sun visors 5-154
 Supplemental Restraint System 4-21
 How the Supplement Restraint System works 4-24
 Servicing 4-36
 Warning light/display..... 4-27

T

Tail and stop lights
 Bulb capacity 9-29
 Replacement 9-35
 Tank capacity 3-4, 11-6
 Theft-alarm system
 System..... 5-40
 Time Setting..... 7-42
 Tire pressure monitoring system..... 5-76
 Warning light/display..... 5-77
 Tires 9-13
 How to change a tire 8-6
 Inflation pressure..... 9-17
 Maintenance..... 9-18
 Quality grading 10-2
 Replacing tires and wheels 9-17
 Rotation..... 9-18

