

Introduction

N09200102068

Thank you for buying a Mitsubishi i-MiEV powered by MiEV (Mitsubishi innovative Electric Vehicle) technology.

We are confident you will enjoy your vehicle. It has been engineered for optimum performance, durability and comfort. By thoroughly reading this Owner's Manual, you will gain an understanding of the many features that are included in the i-MiEV. The Owner's Manual contains descriptions and illustrations that will assist in the operation and maintenance of your vehicle.

A Certified i-MiEV Dealer will be happy to assist you with any further questions you may have regarding the operation of your vehicle. Please note that this manual applies to all i-MiEV models and explains all features including options. Some features explained in this manual may not be installed on your vehicle.

Please leave this Owner's Manual in the vehicle at the time of resale. The next owner will appreciate having access to the information contained here.

This manual includes instructions for standard and optional equipment available at the time of printing. Mitsubishi Motors Corporation reserves the right to make changes in design and specifications and to make additions or improvements in its product without assuming any obligation to install these on previously manufactured products.



Throughout this manual the words **WARNING** and **CAUTION** appear.

These are reminders to be especially careful. Failure to follow the instructions could result in personal injury or damage to your vehicle.

WARNING

Indicates a strong possibility of severe personal injury or death if instructions are not followed.

CAUTION

Points out hazards or unsafe practices that could cause minor personal injury or damage to your vehicle.

You will see another important symbol:
NOTE Gives helpful information.

WARNING

- **Certain fluids contained in vehicles and certain products of component wear contain or emit chemicals known to the State of California to cause cancer and birth defects or other reproductive harm.**



N09348201045

NOTE

Name of Owner	Date of Purchase
Address of Owner	Model of Vehicle
Name and Address of Dealer	Vehicle Identification Number

Maintenance record

Service Performed	Date	Kilometers Miles	Inspection and Maintenance Item

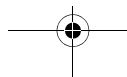
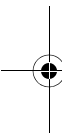

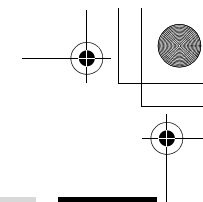
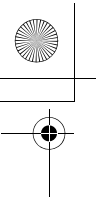
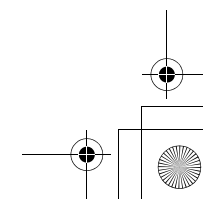
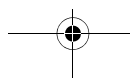
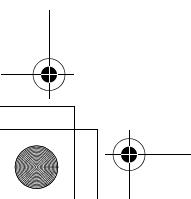
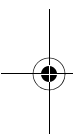

Table of contents

Overview	1
Quick index	2
General information/Charging	3
Seat and restraint systems	4
Features and controls	5
Driving safety	6
Comfort controls	7
For emergencies	8
Vehicle care and maintenance	9
Customer assistance/Reporting Safety Defects	10
Specifications	11
Alphabetical index	12



Instruments and controls (Driver's area)

1 Instruments and controls (Driver's area)

N00100202632

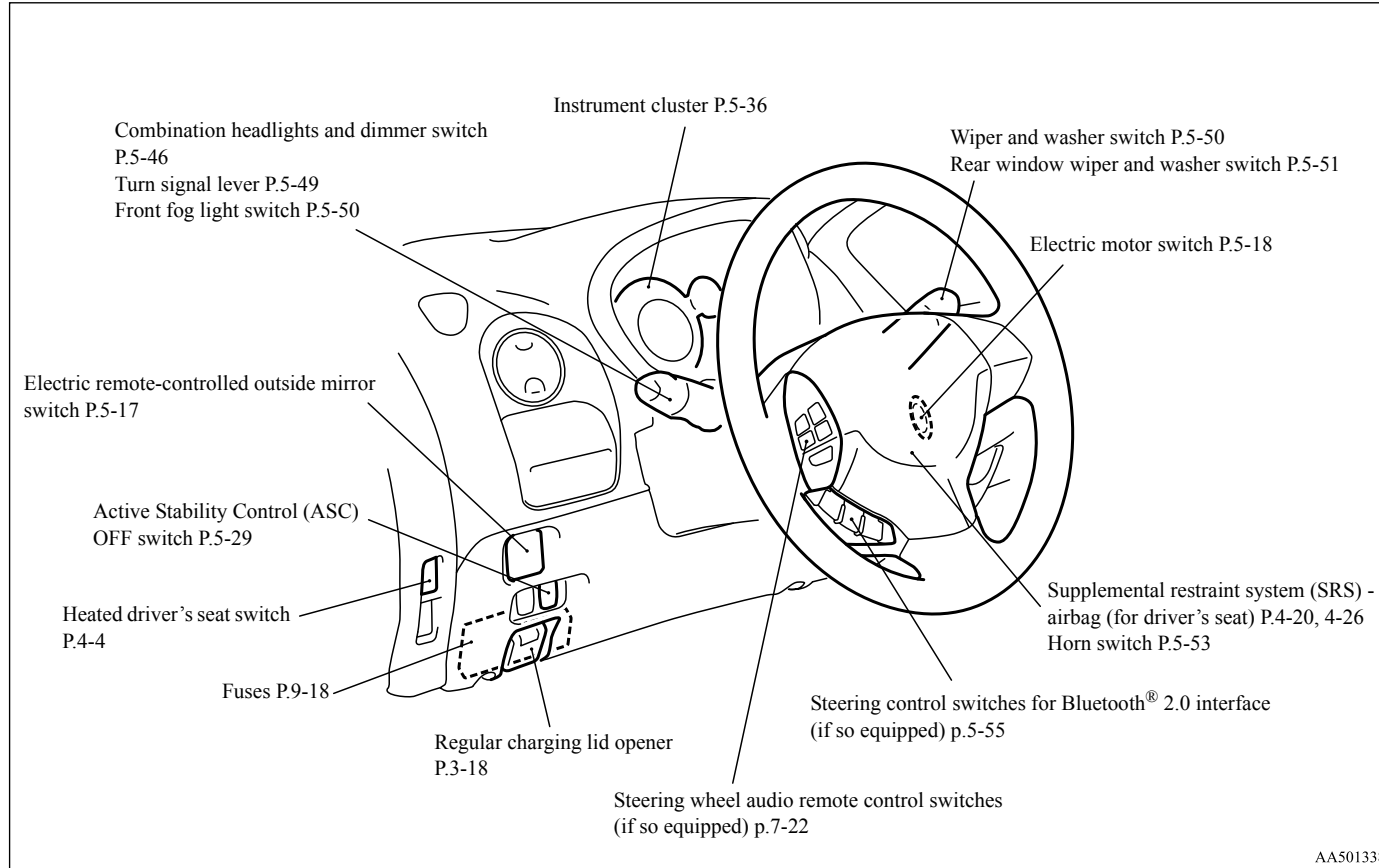

AA5013384

1-1 Overview

Instruments and controls (Instrument panel)

Instruments and controls (Instrument panel)

1

N00100202645

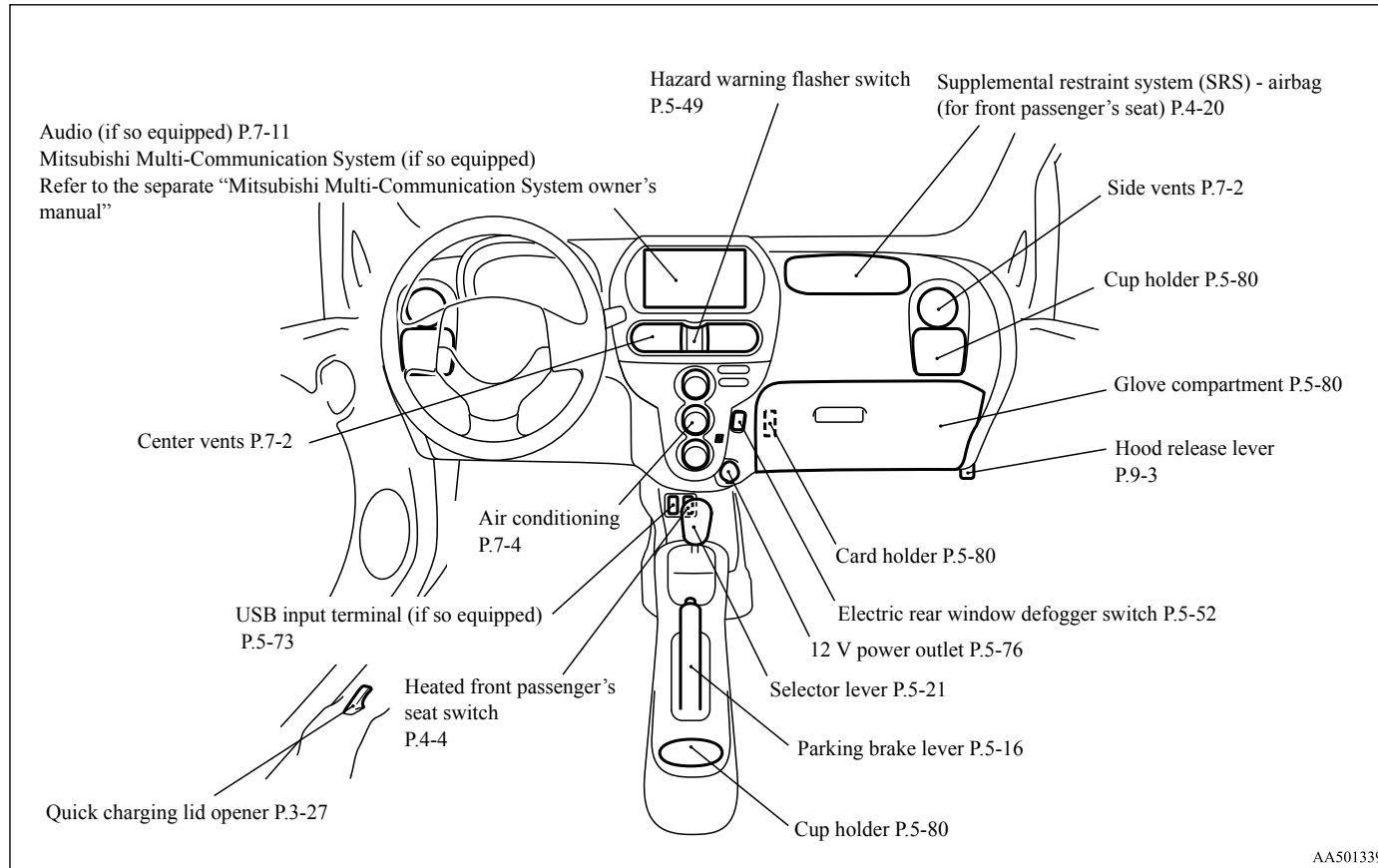

AA5013397

Overview 1-2

Interior

1 Interior

N00100302369

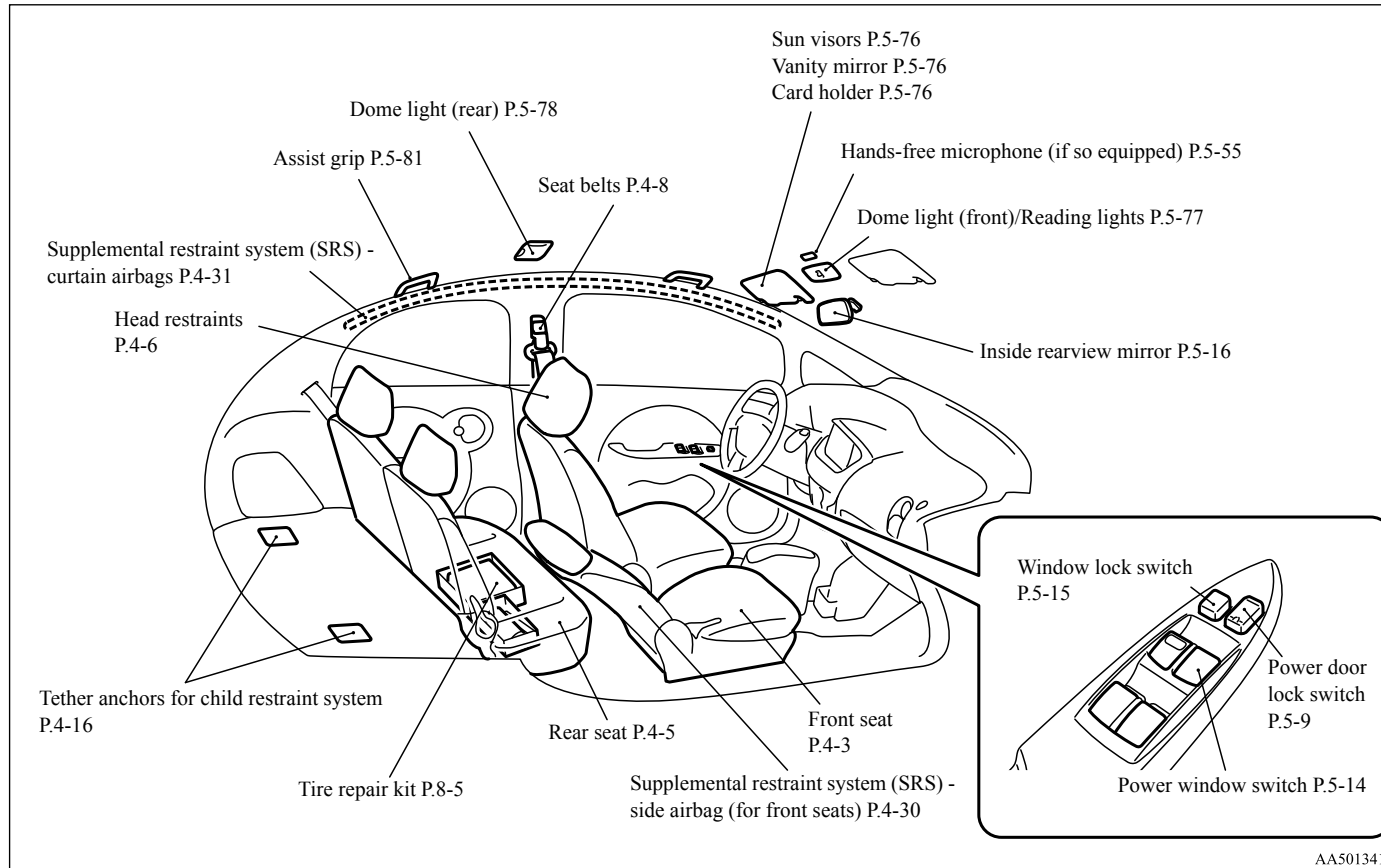

1-3 Overview

Under the hood/Electric motor unit room

Under the hood/Electric motor unit room

1

N0010080041

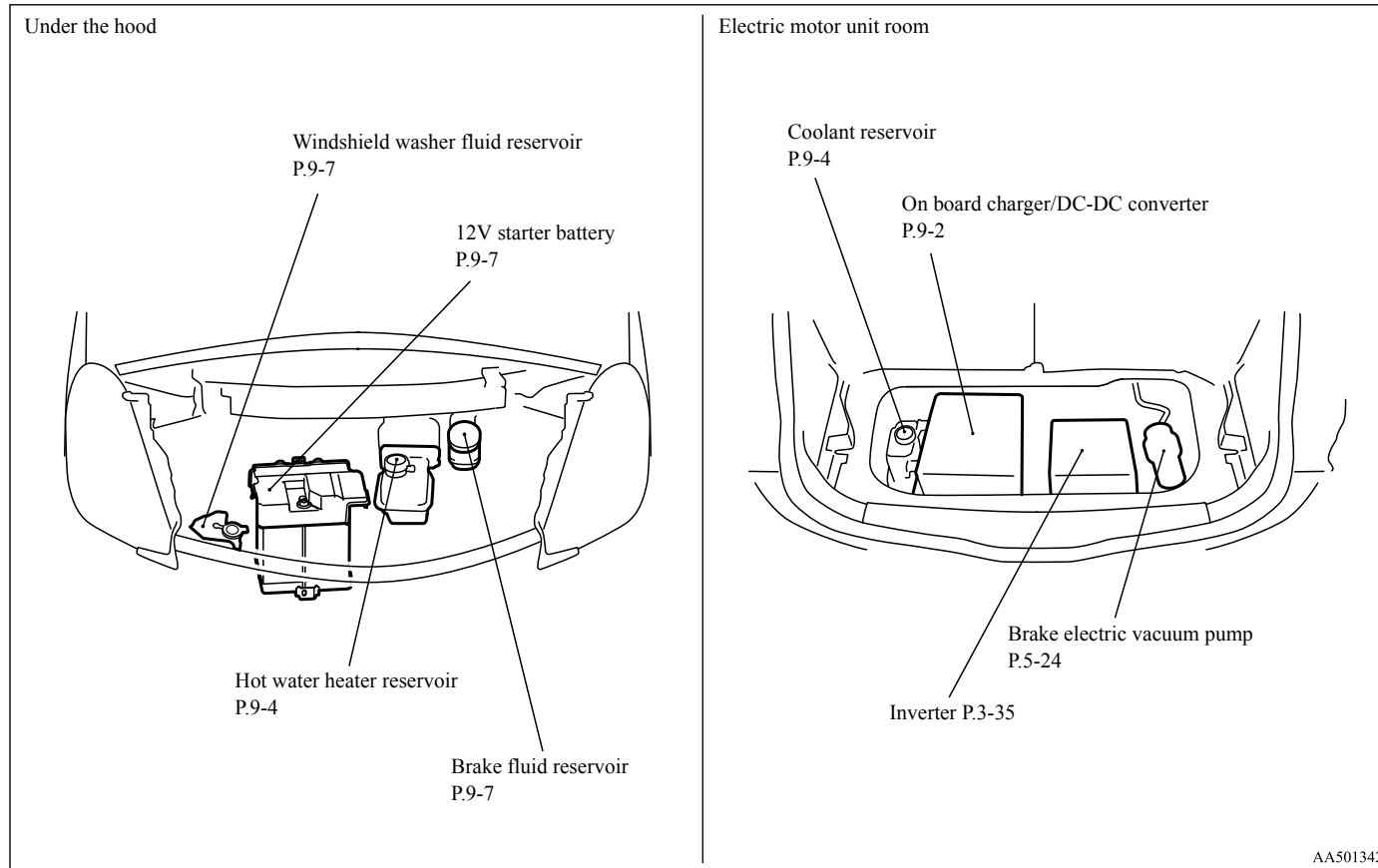

AA5013427

Overview 1-4

Outside (Front)

1 Outside (Front)

N00100602450

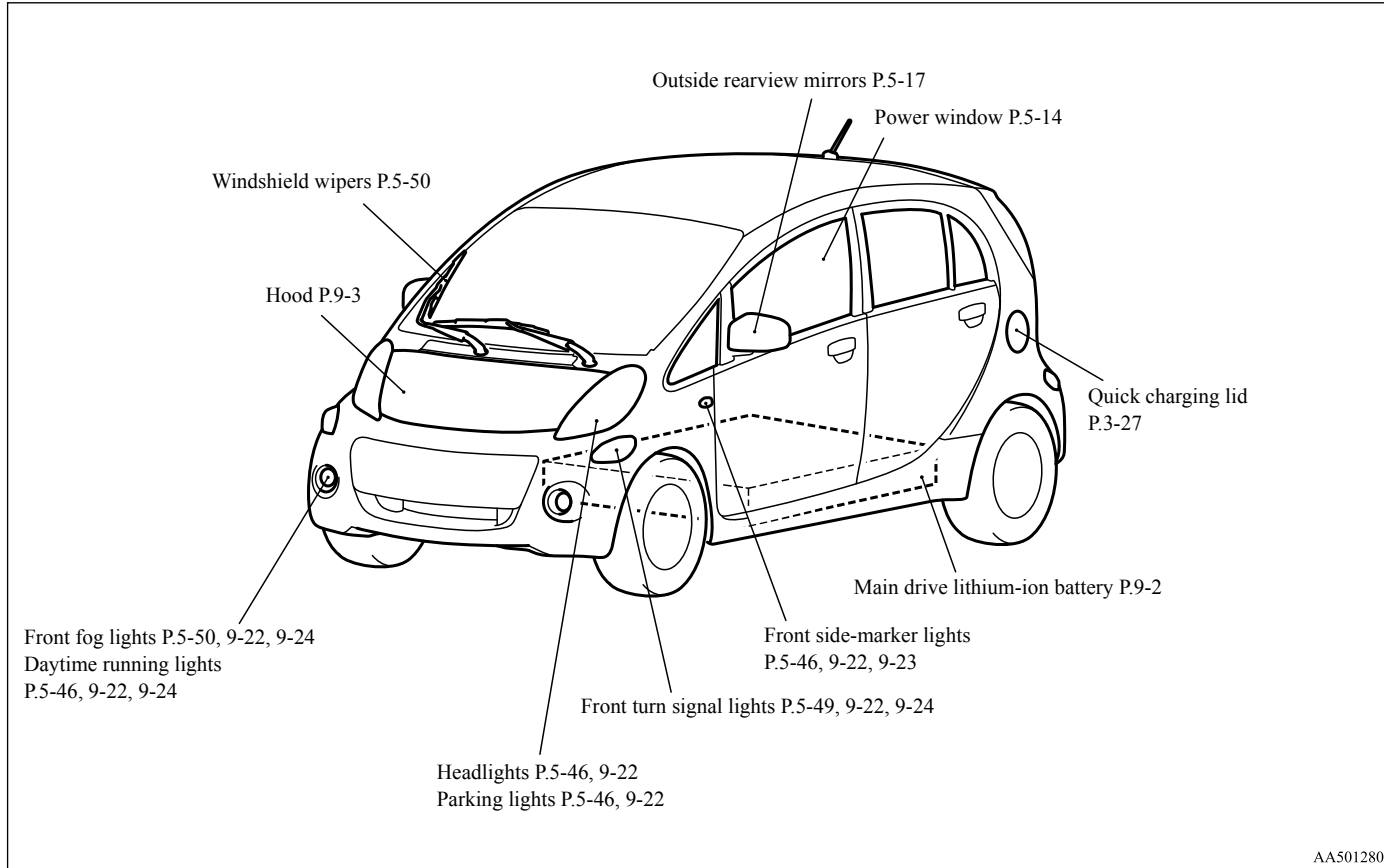

AA5012808

1-5 Overview

Outside (Rear)

1

N00100601352

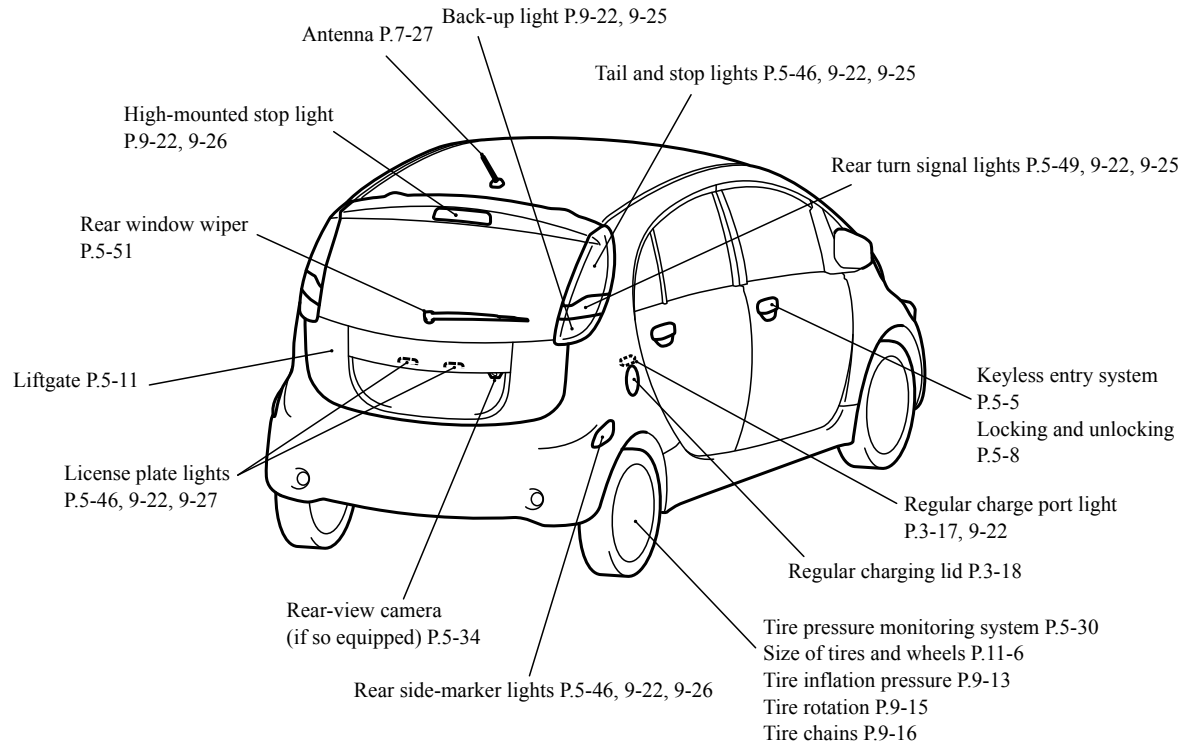

AA5013401

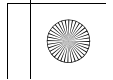
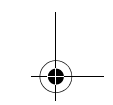
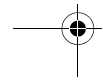
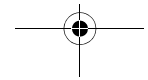
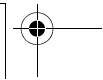
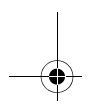
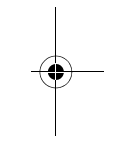
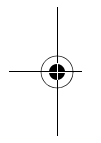
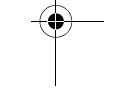
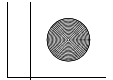
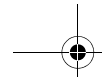
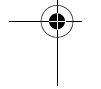
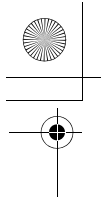

If this warning light comes on or flashes while you're driving...



If this warning light comes on or flashes while you're driving...

N0020070221

2



NOTE

- These warning lights will come on for a few seconds for a bulb check when the electric motor switch is first turned to "ON".



Warning light	Do this	Ref. page
 12V starter battery charging system warning light	<ul style="list-style-type: none"> ● Park your vehicle in a safe place and turn off the electric motor unit. Contact a certified i-MiEV dealer for assistance. 	P.5-45
BRAKE or  Brake warning light	<ul style="list-style-type: none"> ● If this light comes on while driving, check to see that the parking brake is fully released. ● If this light stays on after releasing the parking brake, stop and check the brake fluid level. ● If the brake fluid level is correct, there may be a system malfunction. Avoid hard braking and high speeds, and contact a certified i-MiEV dealer for assistance. 	P.5-44
 Electric motor unit warning light	<ul style="list-style-type: none"> ● Park your vehicle in a safe place and contact a certified i-MiEV dealer for assistance. 	P.5-45

If this warning light comes on or flashes while you're driving...

2

Warning light	Do this	Ref. page
<p style="text-align: center;">EPS</p> <p>Electric power steering system (EPS) warning light</p>	<ul style="list-style-type: none"> ● If this light comes on while the electric motor unit is running, it may become harder to turn the steering wheel. Have your vehicle inspected at a certified i-MiEV dealer as soon as possible. 	<p>P.5-28</p>
<p style="text-align: center;"></p> <p>Anti-lock braking system warning light</p>	<ul style="list-style-type: none"> ● When this light comes on, the anti-lock braking system is not functioning and only the ordinary braking system is functioning. ● Park your vehicle in a safe place and stop the electric motor unit. Test the system as described on page 5-27. ● If the light does not go out after the test, or if it comes on again, we recommend that you have the system checked at a certified i-MiEV dealer as soon as possible. 	<p>P.5-26, 5-27</p>
<p style="text-align: center;"></p> <p>SRS warning light</p>	<ul style="list-style-type: none"> ● Immediately have the airbag and the seat belt pre-tensioner system checked at a certified i-MiEV dealer. 	<p>P.4-13, 4-26</p>
<p style="text-align: center;"></p> <p>Power down warning light</p>	<ul style="list-style-type: none"> ● If this light comes on while driving, avoid sudden acceleration and sudden starting. ● When the remaining power in the main drive lithium-ion battery is low, recharge the main drive lithium-ion battery as soon as possible. 	<p>P.5-46</p>

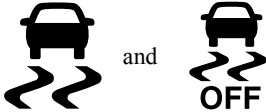
If this warning light comes on or flashes while you're driving...





Warning light	Do this	Ref. page
 <p>Selector lever position indicator in the instrument cluster flashes slowly</p>	<ul style="list-style-type: none"> ● Have the transmission checked at a certified i-MiEV dealer as soon as possible. 	<p>P.5-21</p>
 <p>ASC indicator and ASC OFF indicator</p>	<ul style="list-style-type: none"> ● Park your vehicle in a safe place and turn off the electric motor unit. Restart the electric motor unit and check to see if the indicator comes on again. ● If the indicator does not go out, or if it comes on again, have your vehicle inspected at a certified i-MiEV dealer as soon as possible. ● When this indicator comes on, the active stability control is not functioning and normal operation of the vehicle will not be affected. 	<p>P.5-30</p>
 <p>Tire pressure monitoring system warning light</p>	<ul style="list-style-type: none"> ● If the warning light comes on, you should stop and adjust the tires to the proper inflation pressure as soon as possible. (See “Tire inflation pressures” on page 9-13.) Once adjustments have been made, the warning light will go off after a few minutes of driving. ● If the warning light blinks for approximately 1 minute and then remains continuously illuminated, the system is not operating properly. If the system returns to normal, the warning light will go off. If the warning light does not go off, have the vehicle inspected at a certified i-MiEV dealer. 	<p>P.5-31, 5-32</p>

If this problem occurs...

If this problem occurs...

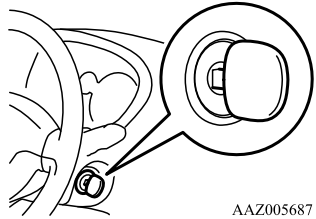
N00200901923

2

Problem	Do this	Ref. Page
<p>Cannot turn the key.</p>  <p>AAZ005687</p>	<p>From “LOCK” to “ACC”. Turn the key while turning the steering wheel in either direction.</p> <p>From “ACC” to “LOCK”. Check the position of the selector lever. The key cannot be removed unless the selector lever is set to the “P” (PARK) position.</p>	<p>P.5-19, 5-20</p>
<p>Cannot shift the selector lever from the “P” (PARK) position.</p>	<p>Shift the selector lever while pressing the brake pedal. Check that the electric motor switch is in the “ON” position.</p>	<p>P.5-21</p>
<p>The windows are fogged up.</p> 	<ol style="list-style-type: none"> 1. Set the mode selection dial to the “” or “” position. 2. Turn on the blower. 	<p>P.7-9</p>
<p>The electric motor unit does not start. The lights do not come on. The lights are dim. The horn does not honk. The horn sound is weak. Cannot charge the main drive lithium-ion battery.</p>	<p>Have the 12V starter battery checked. Recharge or replace as needed.</p>	<p>P.8-2, 9-7</p>

If this problem occurs...

Problem	Do this	Ref. Page
The vehicle is stuck in sand, mud, or snow.	Rock your vehicle back and forth to free it.	P.8-13

2

⚠ WARNING

- When attempting to rock your vehicle out of a stuck position, be sure that no one is near the vehicle. The rocking motion may cause the vehicle to suddenly lurch forward or backward, possibly injuring bystanders.
- Avoid spinning the wheels. Prolonged efforts to free a stuck vehicle may result in transmission failure.

If the vehicle remains stuck after several rocking attempts, have a towing service pull the vehicle out.

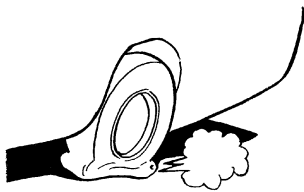
Problem	Do this	Ref. page
The brakes are not functioning properly after driving through water.	Dry out the brakes by driving slowly while lightly pressing the brake pedal.	P.6-5
A tire is punctured. 	<ol style="list-style-type: none"> 1. Park the vehicle in a safe place where the surface is flat and level. 2. Repair the flat tire with tire repair kit. 	P.8-5

Quick index 2-5

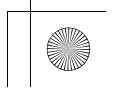
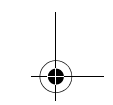
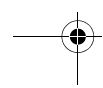
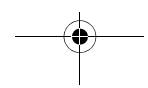
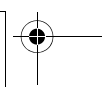
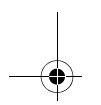
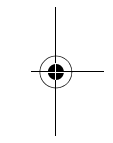
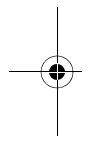
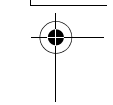
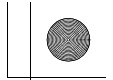
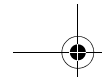
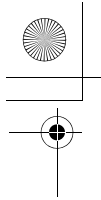

Handwriting practice area consisting of ten horizontal dashed lines.

General information/Charging

3

Familiarizing yourself with i-MiEV	3-2
Modifications to and racing of your vehicle	3-6
Mitsubishi Motors genuine parts	3-8
California Perchlorate Materials Requirements	3-8
Cautions and actions to deal with intense heat	3-8
Cautions and actions to deal with intense cold	3-10
Charging	3-13
Precautions during Charging the Main Drive Lithium-ion Battery	3-15
Regular charging (charging method with rated AC 120 V outlet)	3-16
EV charging cable	3-23
Regular charging (using 240 V Electric Vehicle Supply Equipment)	3-26
Quick charging (charging method with quick charger)	3-27
Charging troubleshooting guide	3-31
High-Voltage components	3-34
MiEV Remote System	3-36

Familiarizing yourself with i-MiEV

Familiarizing yourself with i-MiEV

N01200100013

3

i-MiEV is a pure electric vehicle. Some of the vehicle systems operate differently from and have different characteristics than ordinary vehicles equipped with an internal combustion engine. For this reason, it is very important to read carefully this entire owner's manual.

Main features

N01200200027

- i-MiEV is powered only by electricity. This vehicle does not emit exhaust gases, such as carbon dioxide and nitrogen oxide.
- The i-MiEV uses electricity stored in the lithium ion battery. The lithium-ion battery is called the main drive lithium-ion battery. This vehicle does not have an internal combustion engine and does not require gasoline or diesel fuel.

- The main drive lithium-ion battery must be charged with electricity to drive the vehicle. As the vehicle operates, the main drive lithium-ion battery gradually discharges. If the main drive lithium-ion battery becomes completely discharged, the vehicle will not operate until it is recharged. The charging process can take up to 23 hours as described more precisely in this manual.
- This vehicle uses two types of batteries. One is 12V starter battery that is the same type of the battery used in ordinary vehicles. It is called the 12V starter battery. The other battery which propels the vehicle is called the main drive lithium-ion battery.
- The 12V starter battery provides power to the vehicle systems and features such as the audio system, supplemental restraint systems, headlights and windshield wiper.
- The main drive lithium-ion battery provides power to the electric motor that propels the vehicle and charges the 12V starter battery.
- Through a process called regenerative braking, the main drive lithium-ion battery is automatically charged, while the vehicle is decelerating or being driven downhill.

NOTE

- If the 12V starter battery is discharge, the electric motor unit cannot be started. And also the main drive lithium-ion battery cannot be charged.

WARNING

- Pay special attention to pedestrians. Because there is no engine noise, pedestrians may not know the vehicle is approaching and may step into the path of vehicle travel. Refer to "Acoustic vehicle alerting system (AVAS)" on page 5-23.
- When leaving the vehicle, always turn off the electric motor switch. Refer to "Electric motor switch" on page 5-18.
- When parking, to avoid unintended vehicle movement, always move the selector lever to "P" (PARK) position and apply the parking brake because the vehicle can move when the ready indicator light is ON. When the ready indicator light is ON, do not leave the selector lever in a position other than the "P" (PARK) position. For the ready indicator, refer to "Indicator and warning light package" on page 5-43.

WARNING

- **Keep the brake pedal depressed until you are ready to drive. When the vehicle is in the “D” (DRIVE), “ECO” (ECO MODE), “B” (REGENERATIVE BRAKE MODE) or “R” (REVERSE) position, if you release the brake pedal and even if you do not depress accelerator, the vehicle will creep and may move slowly.**

Regenerative braking

N01205601036

Motion energy is converted into electric energy using the motor as a power generator. While decelerating, electric energy will be created and used to charge to the main drive lithium-ion battery.

- If you lift your foot off the accelerator pedal while driving, a braking force that equivalent to the engine braking of a gasoline or diesel powered vehicle engine will be generate.
For increased regenerative braking, set the selector lever to “B” (REGENERATIVE BRAKE MODE) or “ECO” (ECO MODE) as follows:
 - “B”: Strong regenerative braking (For downhill driving)
 - “ECO”: Moderate regenerative braking (For economical driving or gentle downhill driving)

- As greater brake force is applied by depressing the brake pedal, increased regenerative braking occurs.
- When regenerative braking produces strong brake force, the stop lights will illuminate, even if the brake pedal is not depressed.

NOTE

- When the main drive lithium-ion battery level is full or nearly full, or the main drive lithium-ion battery temperature is too high or too low, the regenerative braking force may be reduced and stronger service brake effort may be required to operate the brakes. When the main drive lithium-ion battery level is no longer full or near full, or the main drive lithium-ion battery temperature has returned to a normal range, the regenerative brake force will resume.
- If a problem occurs in the electric motor unit, or if the ABS and/or the ASC have been activated, the regenerative braking will be restricted. The service brakes will still operate.

Familiarizing yourself with i-MiEV

Main drive lithium-ion battery

N01200300015

WARNING

- **The main drive lithium-ion battery is a sealed high voltage battery and has no user serviceable parts.**
- **To avoid severe burns and/or electrical shock that may result in serious injury or death, never attempt to detach the main drive lithium-ion battery from the vehicle or try to disassemble it.**
- **Never attempt to dispose or recycle the main drive lithium-ion battery by yourself. Consult with a certified i-MiEV dealer, when the main drive lithium-ion battery is disposed or recycled.**
- **Never attempt to use the main drive lithium-ion battery for any other purpose.**

3**CAUTION**

- To help prevent damage to the main drive lithium-ion battery, follow the instructions described below. Failure to do so can result in damage to the main drive lithium-ion battery that will not be covered by the main drive lithium-ion battery warranty.
- Do not leave your vehicle with the energy level gauge (Refer to “Energy level gauge” on page 5-41) showing 0 bars.

Familiarizing yourself with i-MiEV

CAUTION

- Repeatedly performing quick charging can reduce battery capacity. Regular charging is recommended unless quick charging is necessary.
- Do not store your vehicle at ambient temperatures above 131 °F (55 °C) for over 24 hours, or below -13 °F (-25 °C) for over 7 days. The temperatures may damage the main drive lithium-ion battery.

NOTE

- It is recommended that your vehicle be stored at temperatures below 77 °F (25 °C) to help maximize the life of the main drive lithium-ion battery.

Decrease of battery capacity

N01205500012

- The capacity of the lithium-ion battery used as the main drive lithium-ion battery on your i-MiEV, like other commonly used lithium ion batteries, will decrease according to time and usage. This type of decrease in battery capacity is normal, and is not indicative of any defect or failure in your main drive lithium-ion battery. As the main drive lithium-ion battery capacity decreases, the initial cruising range of the vehicle will similarly decrease.

NOTE

- To help maintain the capacity of the main drive lithium-ion battery, the following are recommended:

- Mitsubishi Motors estimates that after 5 years, the capacity of the main drive lithium-ion battery provided with your vehicle will be approximately 80% of the original capacity. After 10 years, the capacity should be approximately 70% of the original capacity. These are only estimates, and the actual capacity of your vehicle battery over time will depend on a variety of factors including how your vehicle is used, stored and charged. Factors that can adversely affect battery capacity over time include frequent driving using aggressive acceleration/deceleration, repeated frequent use of the quick charger, and operation/storage in extreme temperature environments.
- The main drive lithium-ion battery has a limited service life, and when its charging capacity falls, owners should bring their vehicle to a certified i-MiEV dealer for inspection and possible battery replacement.
- For details regarding the warranty coverage for the main drive lithium-ion battery, refer to the Warranty and Maintenance Manual.

NOTE

- Fully charge the vehicle by regular charging every 2 weeks.
- Do not repeat charging when the main drive lithium-ion battery is at or near full charge.

Cruising range

N01200400016

The distance you can drive the vehicle (cruising range) depends on a number of factors including available charge, weather, temperature, usage, battery age, topography, and driving style. When the main drive lithium-ion battery is new, the estimated cruising range with a fully charged main drive lithium-ion battery is 62 miles (100 km) based on the EPA laboratory test commonly called the combined range. Your actual range can vary, either initially or as the battery ages and with use over time.

As the main drive lithium-ion battery capacity decreases, the cruising range of the vehicle will similarly decrease. Refer to “Decrease of battery capacity” on page 3-4.

NOTE

- Since cooling or heating consumes power from the main drive lithium-ion battery, operation of these functions will reduce the cruising range.

NOTE

- Put the selector lever in the “B” (REGENERATIVE BRAKE MODE) or “Eco” (ECO MODE) position according to the road condition. Using appropriate regenerative braking can help increase the cruising range. Refer to “Regenerative braking” on page 3-3.

Range-Driving conditions

N01205900016

Shorten driving range	Driving range	Lengthen driving range
Range Reducing	Condition	Range Extending
High acceleration, speed	Driving style	Low acceleration, speed
Heater on	Heater usage	Heater off (or use seat heater)
A/C on	A/C usage	A/C off
Highway	City/Highway	City
Heavy payload	Payload	Light payload
Windy, wet	Weather	Calm, dry
Uphill, rough	Road conditions	Flat/Downhill, smooth
D-mode	Drive mode	(Eco or B mode)

Modifications to and racing of your vehicle

Operating sound under charging or Remote Climate Control

N01206300020

3

While charging, even if the electric motor switch is in the “LOCK” position, you may hear operating sounds such as sounds from the cooling fan and air conditioning compressor when operating the main drive lithium-ion battery cooling system or Remote Climate Control.

This is normal.

Refer to “Remote Climate Control” on page 3-36, 3-47.

For persons with electro-medical apparatus such as implantable cardiac pacemaker or implantable cardiovascular defibrillator

N01206400021

WARNING

- Before charging, read the instructions described below carefully and follow them. Also read and follow the instructions for “Regular charging (charging method with rated AC 120 V outlet)” on page 3-16, “Regular charging (using 240 V Electric Vehicle Supply Equipment)” on page 3-26, and “Quick charging (charging method with quick charger)” on page 3-27.
- Before charging, individuals using an electro-medical apparatus such as implantable pacemakers and implantable cardiovascular-defibrillators should check with the manufacturer of the apparatus to confirm the effect of the electromagnetic waves from charging. The electromagnetic waves may affect the operations of the electro-medical apparatus.

WARNING

- When performing regular charging, keep your electro-medical apparatus, such as implantable cardiac pacemaker or implantable cardiovascular defibrillator, away from the charge connector, EV charging cable, control box or regular charging station.
- Do not perform quick charging and keep away from a quick charger. Electromagnetic waves produced by a quick charger may affect the operation of your electro-medical apparatus. If you have accidentally approached a quick charger, walk away from the quick charger immediately. If quick charging is necessary, ask someone for help.
- While charging;
 - Do not stay inside the vehicle.
 - Do not go inside the vehicle, for example to remove or place an item in the passenger compartment.
 - Do not open the liftgate, for example to remove or place an item in the cargo area.

Modifications to and racing of your vehicle

N01200500017

This vehicle should not be modified with non-Mitsubishi Motors genuine parts. Mitsubishi Motors designs and manufactures

high quality vehicles with an emphasis on safety and durability. Modifications using non-Mitsubishi Motors genuine parts may affect the performance, safety and/or durability of your vehicle, and may violate applicable state and/or federal regulations.

DAMAGE OR PERFORMANCE PROBLEMS RESULTING FROM MODIFICATIONS TO OR RACING OF YOUR VEHICLE ARE NOT COVERED UNDER WARRANTY.

Examples of modifications to your vehicle that can cause damage or performance problems include the following:

- Failure to use Mitsubishi Motors genuine parts
- Failure to use required fluids (refer to “Refill capacities” on page 11-7)
- Failure to use proper size tires and wheels
- Modification of the suspension, electric motor, drive train, batteries (main drive lithium-ion battery and 12V starter battery), charging systems or electrical wiring systems
- Modification of any onboard computer/control module, including reprogramming, or replacing/adding chips to any onboard computer/control module

Review the Warranty and Maintenance Manual for further details regarding warranty coverage.

Installation of accessories

N0120060018

CAUTION

- Before any electrical or electronic accessories are installed, consult a certified i-MiEV dealer.

- The installation of accessories, optional parts, etc., should only be carried out within the limits prescribed by law in the driving area and in accordance with the guidelines and warnings contained within the documents accompanying this vehicle. Only Mitsubishi Motors approved accessories should be fitted to your vehicle.
- Improper installation of electrical parts could cause fire. Refer to the “Modification/alterations to the electrical systems” section within this owner’s manual.
- Tires and wheels which do not meet specifications must not be used. Refer to the “Specifications” section for information regarding wheel and tire sizes.

Modifications to and racing of your vehicle

WARNING

- If you choose to use a cellular phone while driving, you must not allow that usage to distract you in the safe operation of your vehicle. Anything, including cellular phone usage, that distracts you from the safe operation of your vehicle increases your risk of an accident. Refer to and follow all local laws in your area regarding cellular phone usage while driving.

3

Important point!

Due to the large number of accessory and replacement parts provided by different manufacturers in the market, it is not always possible for a certified i-MiEV dealer to check whether the attachment or installation of non-Mitsubishi Motors genuine parts will affect the driving safety of your Mitsubishi-vehicle.

Modification/alterations to the electrical systems

N01200700019

Mitsubishi Motors manufactures high quality vehicles with an emphasis on safety. It is important to consult a certified i-MiEV dealer before installation of any accessory which

General information/Charging 3-7

Mitsubishi Motors genuine parts

may involve modification of the electrical systems.

3

CAUTION

- Please consult a certified i-MiEV dealer concerning any such accessory fitment or modification.
If the wires interfere with the vehicle body or improper installation methods are used (protective fuses not included, etc.), electronic devices may be adversely affected, resulting in a fire, vehicle damage, or other accident.

Mitsubishi Motors genuine parts

N0120080010

Mitsubishi Motors Genuine Parts are designed and manufactured to meet high standards of performance, and are recommended for all of your maintenance needs. Also available from a certified i-MiEV dealer are a wide variety of accessories to personalize your new vehicle. Each Mitsubishi vehicle has a selection of Mitsubishi Motors authorized accessories to choose from to tailor your new vehicle to your own personal preference. A certified i-MiEV dealer's Parts Manager has information on various audio systems,

protection items, as well as interior and exterior accessories available for your specific model.

California Perchlorate Materials Requirements

N0120090011

Certain components of this vehicle, such as airbag modules, seat belt pretensioners, and button cell batteries, may contain perchlorate materials.

Special handling may apply. For additional information, see www.dtsc.ca.gov/hazardous-waste/perchlorate.

Cautions and actions to deal with intense heat

N0120100145

- When the vehicle is driven in a high ambient temperature, its air-conditioner performance can be insufficient. Also, using the air conditioner will reduce the vehicle's cruising range.
- When the ambient temperature is approximately 104 °F (40 °C) or higher, the phenomena described below may occur. Please take the described actions.
- Even if the ambient temperature is approximately 104 °F (40 °C) or lower, when performing quick charging, driving at high-speed and uphill repeatedly, the phenomena described below may occur. Please take the described actions.

Cautions and actions to deal with intense heat

Approx. ambient temperature	Phenomena		Corrective action
Approx. 104 °F (40 °C) or higher	Startup and driving	<ul style="list-style-type: none"> • During quick charging, repeated high-speed driving, or repeated uphill driving, the power down warning light* comes on and the motor output is restricted to protect the main drive lithium-ion battery or motor (electric motor unit). • Regenerative braking performance may decrease. When braking, depress the brake pedal more strongly. • If you continue driving after the power down warning light* comes on, the vehicle may stop after you have driven a few miles/kilometres. 	<ul style="list-style-type: none"> • Stop the vehicle in a safe place for a while, avoid quick charging, and wait for the power down warning light* to go off.
	Charging and battery	<ul style="list-style-type: none"> • During quick charging, charging times get longer. 	
	Approx. 113 °F (45 °C) or higher	Startup and driving	
Charging and battery		<ul style="list-style-type: none"> • The EV charging cable (regular charging cable) cannot be used. • During quick charging, charging times get longer. • The main drive lithium-ion battery capacity is decreased more quickly, and the cruising range is decreased. 	<ul style="list-style-type: none"> • Park in a safe, well-ventilated and shady place.

3

Cautions and actions to deal with intense cold

3

Approx. ambient temperature	Phenomena		Corrective action
Approx. 140 °F (60 °C) or higher	Startup and driving	<ul style="list-style-type: none"> The power down warning light* comes on, and the vehicle may stop. 	<ul style="list-style-type: none"> Park in a safe, well-ventilated and shady place, avoid quick charging, and wait for the power down warning light* to go off.
	Charging and battery	<ul style="list-style-type: none"> The EV charging cable (regular charging cable) cannot be used. Quick charging may become impossible. 	<ul style="list-style-type: none"> Park in a safe, well-ventilated and shady place.

NOTE

- *: Refer to “Power down warning light” on page 5-46. Illumination of the power down warning light does not indicate a malfunction.

Cautions and actions to deal with intense cold

N01201101033

- When the vehicle is driven in a low ambient temperatures, its heater performance can be insufficient. Also, using the heater can reduce the vehicle’s cruising range.
- When the ambient temperature is approximately 5 °F (-15 °C) or lower, the phenomena described below may occur. Please take the corrective actions described below.

Cautions and actions to deal with intense cold

Approx. ambient temperature	Phenomena		Corrective action
Approx. 5 °F (-15 °C) or lower	Startup and driving	<ul style="list-style-type: none"> Motor output is restricted, and the power down warning light*¹ may come on. <Reference: When the main drive lithium-ion battery temperature is 5 °F (-15 °C) or lower and the main drive lithium-ion battery's remaining power is 50 %, the driving performance may decrease by approximately 30 %> Regenerative braking performance may decrease. 	<ul style="list-style-type: none"> Keep driving if you can drive at a safe speed. If you cannot drive at a safe speed, stop the vehicle in a safe place and charge the main drive lithium-ion battery. When braking, depress the brake pedal more strongly.
	Charging and battery	<ul style="list-style-type: none"> Charging times get longer. Complete charging may not be possible. 	<ul style="list-style-type: none"> When you have finished driving, charge the main drive lithium-ion battery before battery temperature falls.
Approx. -13 °F (-25 °C) or lower	Startup and driving	<ul style="list-style-type: none"> Motor output is restricted, and the power down warning light*¹ may come on. <Reference: When the main drive lithium-ion battery temperature is -13 °F (-25 °C) or lower and the main drive lithium-ion battery's remaining power is 50 %, the driving performance may decrease by approximately 50 %> Regenerative braking performance may decrease or be eliminated. 	<ul style="list-style-type: none"> Keep driving if you can drive at the same speed as surrounding vehicles. If you cannot drive the same speed as surrounding vehicles, stop the vehicle in a safe place and charge the main drive lithium-ion battery. When braking, depress the brake pedal more strongly.
	Charging and battery	<ul style="list-style-type: none"> Charging may become impossible. 	<ul style="list-style-type: none"> When you have finished driving, charge the main drive lithium-ion battery before battery temperature falls.

3

Cautions and actions to deal with intense cold

3

Approx. ambient temperature	Phenomena		Corrective action
Approx. -22 °F (-30 °C) or lower	Startup and driving	<ul style="list-style-type: none"> • The ready indicator*² does not come on, and startup may not be possible. • In the worst-case scenario, the vehicle may become undrivable (with the energy level gauge and cruising range indications still shown). • Regenerative braking performance may decrease or be eliminated. 	<ul style="list-style-type: none"> • In the daytime, wait for the temperature to rise. When the temperature in the vicinity of the main drive lithium-ion battery has risen, start up.
	Charging and battery	<ul style="list-style-type: none"> • Charging may become impossible 	<ul style="list-style-type: none"> • When braking, depress the brake pedal more strongly • In the daytime, wait for the temperature to rise. When the temperature in the vicinity of the main drive lithium-ion battery has risen, begin charging.

 **NOTE**



- *¹: Refer to “Power down warning light” on page 5-46. Illumination of the power down warning light does not indicate a malfunction.
- *²: Refer to “Ready indicator” on page 5-44.

Charging

N01201201047

Your vehicle comes standard with a charge port and charging cable (EV charging cable) that uses a household outlet (AC 110-120V) as a charging source. You may also charge your vehicle using an i-MiEV compatible 220-240V charging device (EVSE*¹ - available separately). Your vehicle comes equipped with an additional quick charge port to be used with a CHAdeMO*² quick charger.

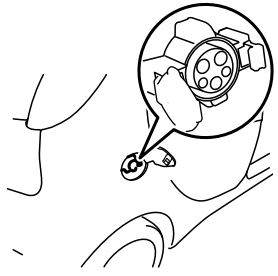
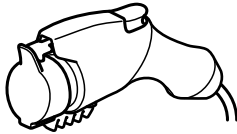
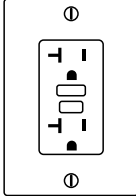
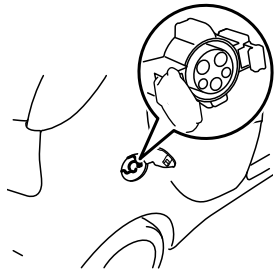
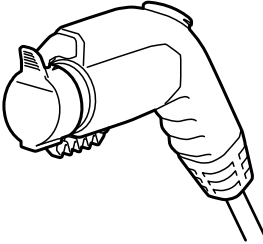
3

Category	Charge port	Charge connector	Charging Source	Charging time	Reference
Level 1 Regular charging 110-120V (Attached EV charging cable)	 passenger side of vehicle		 110-120V household outlet (15 amp dedicated circuit required)	120V/8A: Approximately 22-25 hours 120V/12A: Approximately 14-16 hours	P.3-16
Level 2 Regular charging 220-240V (Primary Home EVSE* ¹ Dock-Available separately)	 passenger side of vehicle		 Home or public charging device	Approximately 6-7 hours	P.3-16, 3-26

Charging

3

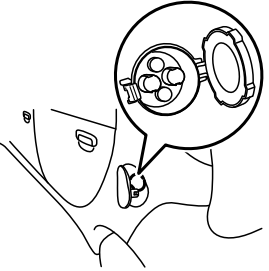
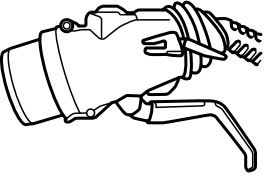
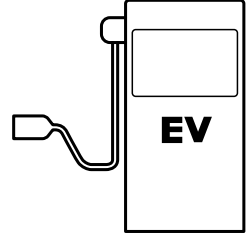
Category	Charge port	Charge connector	Charging Source	Charging time	Reference
Quick charging (charging method with quick charger)	 driver side of vehicle		 Public charging stations where available	Approximately 30 minutes for 80 % charge	P.3-27

*1: EVSE = Electric Vehicle Supply Equipment

*2: CHAdeMO is a standard for quick charging of electric vehicle originally started in Japan, and the contents have also become international standard.

Charging time will vary depending on battery condition, air temperature and condition of power source (such as specification of the quick charger).

A vehicle equipped with a quick charge port is compatible with most CHAdeMO connectors on charging stations. Charging stations using the CHAdeMO standard are UL certified and safe to use in the US.

NOTE

- The 12V starter battery will be automatically charged during charging and also while the ready indicator is illuminated. Refer to “Ready indicator” on page 5-44.
- Repeatedly performing only quick charging can reduce battery capacity. Regular charging is recommended unless quick charging is necessary.
- If the 12V starter battery is discharged, the main drive lithium-ion battery cannot be charged. Refer to “Jump-starting” on page 8-2.

Precautions during Charging the Main Drive Lithium-ion Battery

Precautions during Charging the Main Drive Lithium-ion Battery

N01202601051

⚠ WARNING

- Improper charging can result in a fire, property damage, and serious injury or death.

Read the instructions described below carefully and follow them. Also read and follow the instructions for “Regular charging (charging method with rated AC 120V outlet)” on page 3-16, Regular charging (using 240V Electric Vehicle Supply Equipment) on page 3-26 and “Quick charging (charging method with quick charger)” on page 3-27 before using the charging device.

- Do not touch regular charge port, regular charge connector, plug and outlet with wet hands.
- Keep away from water when connecting the regular charge port, regular charge connector, plug and outlet.
- Do not perform charging outdoors in adverse weather, such as heavy rain, heavy snow or strong winds, or when adverse weather is expected.

⚠ WARNING

- Never charge or touch the vehicle when lightning or thunder is observed or expected. A lightning strike may back feed into the regular charger causing damage and possible personal injury or death. If lightning or thunder begins during regular charging, do not touch the vehicle or the EV charging cable and turn off the breaker.
- Make sure there is no water or foreign materials in the charge port, charge connector or plug, and that they are not damaged or affected by rust or corrosion. If any of these conditions are noticeable, do not charge the main drive lithium-ion battery.
- Never touch the metal contacts of the charge port, charge connector or plug.
- Never disassemble or modify the charge port or charging cable.
- If you notice unusual odor or smoke coming from the vehicle, charging cable or plug, or if the charging cable or plug becomes hot to the touch, stop charging immediately.
- Keep away from the cooling fan under the hood during charging. During charging, the cooling fan may automatically be operated even if the electric motor switch is in the “LOCK” position.

⚠ WARNING

- Some public regular chargers may not be compatible with your vehicle. If necessary, consult an administrator or the maker of the regular charger to determine whether the charger is compatible with your vehicle before using it. Also be sure to use the regular charger according to operating procedures indicated on the body of the regular charger.

3

⚠ CAUTION

- Do not place the selector lever in any position other than the “P” (PARK) position while the regular charger is connected. If the selector lever is placed in a position other than the “P” position, the vehicle could accidentally move resulting in damage to the regular charge connector. If the selector lever is placed in any position other than “P” position while the regular charge connector is still connected and the electric motor switch is the “ON” position, a warning buzzer will sound.
- To prevent damage to the charging equipment:
 - Do not close the charge port lid without closing the cap.
 - Do not subject the charging equipment to impact.
 - Do not pull or twist the charge cable.
 - Do not drag the charge cable.

Regular charging (charging method with rated AC 120 V outlet)

3

CAUTION

- Do not store charging equipment in locations where the temperature is above 185 °F (85 °C) or below -40 °F (-40 °C).
- Do not place the charging equipment close to a heater or other heat source.
- Make sure the inner cap is closed on the charge port when charging is finished. If the charge port lid is closed when the cap is opened, water or foreign materials may enter the charge port.
- Do not charge when a vehicle body cover is in use.
This may cause damage to the charge connector.
- Do not attempt to perform a jump start on the 12V starter battery at the same time that the main drive lithium-ion battery is being charged. Doing so may damage the vehicle or charging cable and could cause an injury. See “Jump-starting” in the “6. For emergency” section.
- Forcing the charge connector to connect may cause damage to the charging equipment and vehicle.

NOTE

- Repeatedly performing only quick charging can reduce the battery capacity. Regular charging is recommended unless quick charging is necessary.

NOTE

- To help maintain the capacity of the main drive lithium-ion battery, the following is recommended:
 - If you repeatedly perform only the quick charging, fully charge the vehicle by regular charging every 2 weeks.
 - Do not repeat charging when the main drive lithium-ion battery is at or near the full charge.
- Both of the regular charging and quick charge cannot be performed at the same time. The quick charging is given priority.
- While charging, even if the electric motor switch is in the “LOCK” position, you may hear operating sounds such as sounds from the cooling fan and air conditioning compressor when operating the main drive lithium-ion battery cooling system or Remote Climate Control. This is normal. Refer to “Remote Climate Control” on page 3-36, 3-47.
- It is recommended that you perform regular charging from 2 bars or less on the energy level gauge to full at least once every three months. This allows the energy level gauge to adjust to decreased battery capacity and correctly display the remaining energy in the main drive lithium-ion battery. A certified i-MiEV dealer can also adjust the energy level gauge for you when requested.

Regular charging (charging method with rated AC 120 V outlet)

N01203101040

Carefully read instructions regarding “Precautions during charging the main drive lithium-ion battery” on page 3-15 and described in this section and also instructions on “EV charging cable” on page 3-23 or instructions for a charging device you use, and follow them.

WARNING

- **Improper charging can result in a fire, property damage, and serious injury or death.**
- **Always use a grounded outlet protected by a ground-fault circuit interrupter, rated AC 120V and rated for 15A or more connected to a dedicated branch circuit. If the outlet is not grounded, the risk of electrical shock will increase in the event of an insulation failure in the EV charging cable.**
If the circuit is shared, and another electrical device is being used at the same time the vehicle is charging, the circuit may heat abnormally, the breaker may trip and the circuit may cause adverse interference on household electrical appliances such as televisions and audio systems.

Regular charging (charging method with rated AC 120 V outlet)

⚠ WARNING

- Individuals using an electro-medical apparatus such as implantable pacemakers and implantable cardiovascular-defibrillators should check with the manufacturer of the apparatus to confirm the effect of the electromagnetic waves from charging. The electromagnetic waves may affect the operations of the electro-medical apparatus.
- If you use an electro-medical apparatus, such as an implantable cardiac pacemaker or an implantable cardiovascular defibrillator, observe the following precautions before charging:
 - Keep your electro-medical apparatus away from the charge connector, EV charging cable, control box and regular charging station.
 - While regular charging;
 - Do not stay inside the vehicle.
 - Do not go inside the vehicle, for example to remove or place an item in the passenger compartment.
 - Do not open the liftgate, for example to remove or place an item in the cargo area.
- To reduce the risk of electric shock, connect only to a properly grounded and waterproofed outlet.
- Never use an extension cable, multi-plug adapter or conversion adapter. Using them may cause overheating resulting in fire.

⚠ WARNING

- Never force the connection if the charging cable or plug shows damage or is not easily connected due to foreign material entering the plug or the outlet.
- Never use an outlet that is worn, damaged, or will not hold the plug firmly.
- Make sure that the plug is inserted all the way into the outlet before use.
- While it is normal for the plug and charging cable to become warm during charging, discontinue use immediately if the plug or charging cable becomes too hot to touch.
- Never pull the cable to remove the plug.
- Never connect or disconnect the plug with a wet hand.

📖 NOTE

- Your vehicle is equipped with an EV charging cable for regular charging. Refer to “EV charging cable” on page 3-23.
- When connecting or disconnecting the regular charge connector, insert/pull out the connector straight. Also, do not incline or twist the connector. Doing so could cause a bad connection or malfunction.
- Make sure to lock the doors to prevent theft, etc. during charging.

Regular charge port light

N01216200019

3

Regular charge port light (A) comes on when the UNLOCK button on the remote control transmitter is pressed, or when any door or the liftgate is opened. The regular charge port light and the dome lights (with the dome light switch in the “DOOR” position) will come on simultaneously. However, the regular charge port light will not come on when you press the dome light (front) lens or slide the dome light (rear) switch to the “ON” position.

For details, refer to “Keyless entry system” on page 5-5, “Dome light (Front)/Reading lights” on page 5-77 and “Dome light (Rear)” on page 5-78.

To turn on the charge port light again, press the UNLOCK button on the remote control transmitter, or open any door or the liftgate.

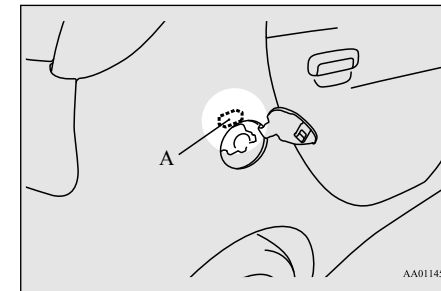

Regular charging (charging method with rated AC 120 V outlet)

NOTE

- The time until the light goes off can be adjusted. See a certified i-MiEV dealer for details.

3

Charging from rated AC 120 V outlet

N01203201041

1. Fully apply the parking brake and place the selector lever to the “P” (PARK) position.
2. Stop the electric devices such as lamps and turn the electric motor switch to the “LOCK” position.
3. Pull the regular charging opener (B) at the bottom left of the instrument panel to open the regular charging lid (C) at the right rear side of the vehicle.

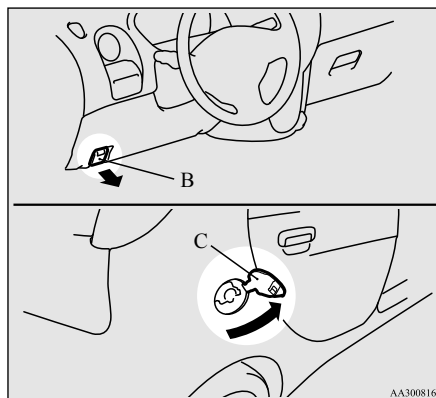

4. Remove key and lock the vehicle.
5. Press the tab (D) to open the inner lid (E).

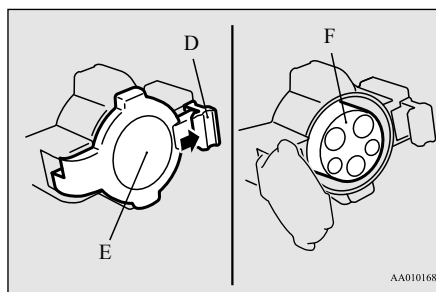

WARNING

- Do not touch the metal terminal of the charge port (F) and the regular charge connector. Doing so could cause an electric shock and/or malfunction.

CAUTION

- To help keeping foreign material out of the charge port, do not leave the inner lid open without connecting the charge connector.

NOTE

- There is a hole on the charge port for water drainage. If this hole is blocked and water gets trapped in the charge port, do not charge. Contact a certified i-MiEV dealer.
- If the charge port becomes frozen, use a hair dryer to defrost and dry the regular charge port before charging. Forcing the charging connector to connect with the regular charge port while it is frozen can damage the regular charge port and/or prevent charging.

6. Insert the charging cable plug into an outlet.

Regular charging (charging method with rated AC 120 V outlet)

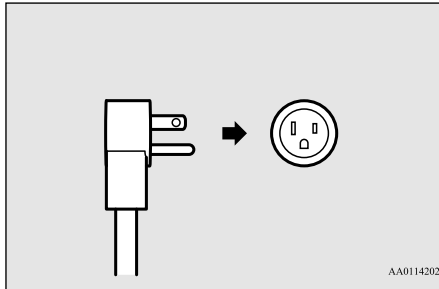

WARNING

- Make sure that the plug is inserted all the way into the outlet before use.
- To reduce the risk of electric shock or fire due to electric leak, always use a grounded outlet protected by a ground-fault circuit interrupter, rated AC 120V and rated for 15A or more, that is connected to a dedicated branch circuit. If the outlet is not grounded, the risk of electrical shock will increase in the event of an insulation failure in the EV charging cable. If the circuit is shared, and another electrical device is being used at the same time the vehicle is charging, the circuit may heat abnormally, the breaker may trip and the circuit may cause adverse interference on the household electrical appliances such as televisions and audio systems.

WARNING

- Never use an extension cable, multi-plug adapter or conversion adapter. Using them may cause overheating resulting in fire.
- To prevent an electrical shock or fire, do not use a multi type outlet. The grounded line may not work properly and it is not a dedicated type outlet.
- To reduce the risk of electric shock, connect only to a properly grounded and waterproofed outlet.
- Always use an AC 120V outlet rated for 15A or more.

7. Press the 8A/12A manual selection button (G) on the control box to charge quickly when needed. If selected, the 12A indicator (H) will illuminate.

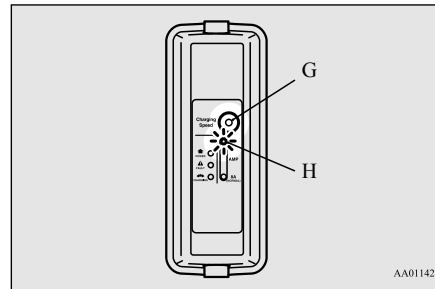

WARNING

- If the selected electrical current level exceeds the electrical current capacity of the electrical circuit or outlet being used for charging, the circuit and outlet can overheat resulting in fire. If the capacity of an outlet and its electrical circuit are unknown, do not use the outlet for charging the vehicle.

3

8. Open the cap (I) on the regular charge connector (J) and make sure that there is no foreign matter such as dust at the end of the regular charge connector and the regular charge port.

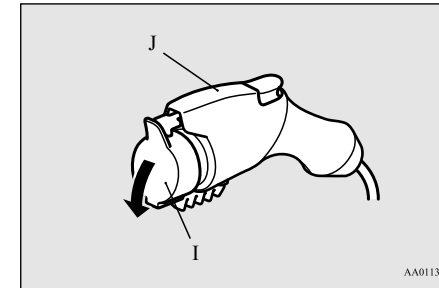

9. Connect the regular charge connector until a click is heard without pressing the button (K).

Regular charging (charging method with rated AC 120 V outlet)

3

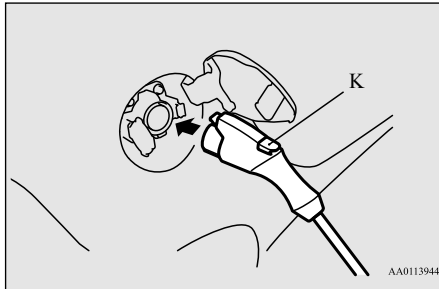

CAUTION

- Do not clasp the top of regular charge connector. It could cause injury to from the protrusion on the lid.

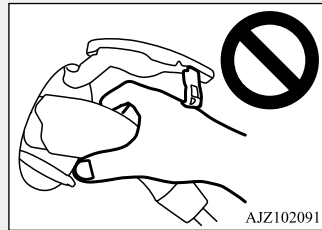

NOTE

- If the electric motor switch is turned to the "START" position with the regular charge connector connected to the regular charge port, the electric motor unit cannot be started.

NOTE

- Do not connect or disconnect the regular charge connector repeatedly in a short time period. You may experience difficulty charging your vehicle.

10. Make sure that the charging indicator on the instrument cluster is illuminated.

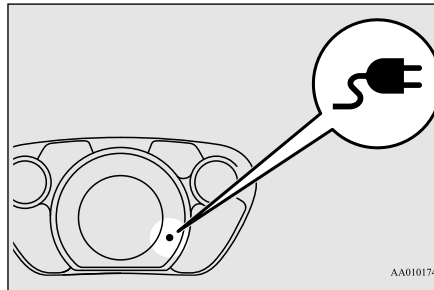

If the charging indicator is not illuminated, charging will not start. Make sure that the regular charge port, the plug and the connector are correctly connected, and perform charging from Step 5 again.

NOTE

- When the regular charge connector is connected to the regular charge port, the charging indicator is blinking. When charging is started, the charging indicator is illuminated.

NOTE

- The charge level for main drive lithium-ion battery can be checked with the energy level gauge (L) on the instrument cluster. Refer to "Energy level gauge" on page 5-41.

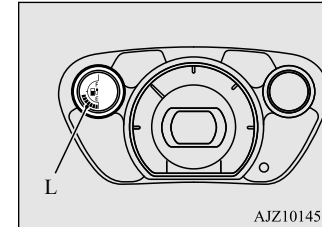

- You may hear operating sounds from the main drive lithium-ion battery cooling system, such as sounds from the cooling fan and air conditioning compressor, during regular charging. This is normal.

11. Charging is complete when the charging indicator turns off. Pull out the regular charge connector while pressing the button (M).

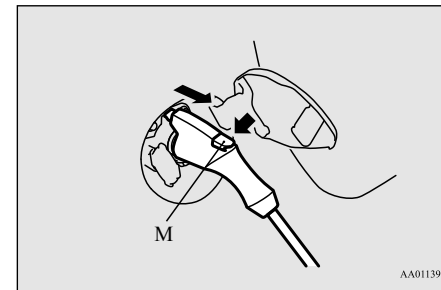

Regular charging (charging method with rated AC 120 V outlet)

WARNING

- After charging, disconnect the charge connector completely from the regular charge port. If the charge connector remains partially engaged with the latch unlocked, the electric motor switch can be turned to the "START" position and the vehicle can be moved.

NOTE

- Charging can be stopped half way. In this case, pull out the regular charge connector while pressing the button.

12. Close the inner lid and close the regular charging lid.

WARNING

- After charging, be sure to close the inner lid and the regular charging lid completely. Be careful that water or dust does not enter in the regular charge port inner lid and regular charge connector. Entry of water or dust could cause electric leakage, resulting in a fire or electric shock.

NOTE

- Make sure that the inner lid is completely closed before closing the regular charging lid. If the regular charging lid is forcibly closed without completely closing the inner lid, the hinge on the inner lid may be broken.

13. Remove the charging cable plug from the outlet.
14. Install the cap on the regular charge connector.

Main drive lithium-ion battery warming system

N01202501047

You cannot charge the main drive lithium-ion battery when the main drive lithium-ion battery temperature is -13°F (-25°C) or lower. The air conditioning will automatically operate and the main drive lithium-ion battery will be heated when all the following conditions are met.

- The main drive lithium-ion battery temperature is between -22°F (-30°C) and -13°F (-25°C).
- The energy level gauge shows 4 bars or more of full charge.
- The electric motor switch is in the "LOCK" position.

- The regular charge connector is connected to the regular charge port. The energy level gauge (A) in the instrument cluster and charging indicator (B) illuminate while the main drive lithium-ion battery warming system is operating. The main drive lithium-ion battery warming system will automatically stop when the main drive lithium-ion battery temperature is -4°F (-20°C) or higher.

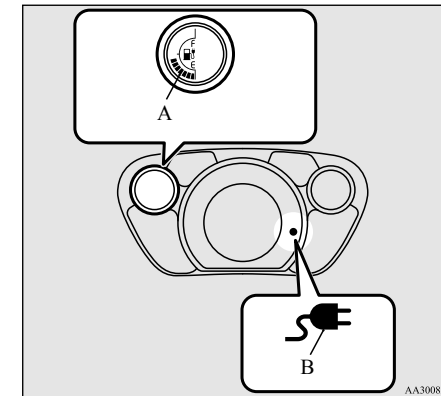
3

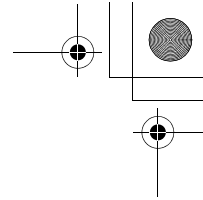
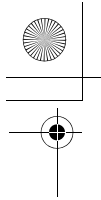

Regular charging (charging method with rated AC 120 V outlet)

3

NOTE

- When the main drive lithium-ion battery warming system operates while the remote climate control is operating, the remote climate control stops. When the main drive lithium-ion battery warming system stops, the remote climate control operates again.

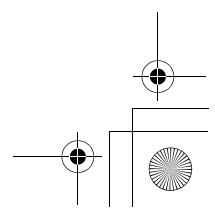
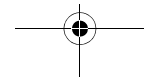
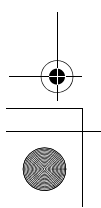
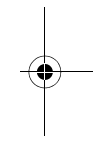
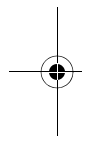

EV charging cable

N01202801053

Your vehicle is equipped with an EV charging cable that consists of a cable (A), control box (B), plug (C), and regular charge connector (D).

3

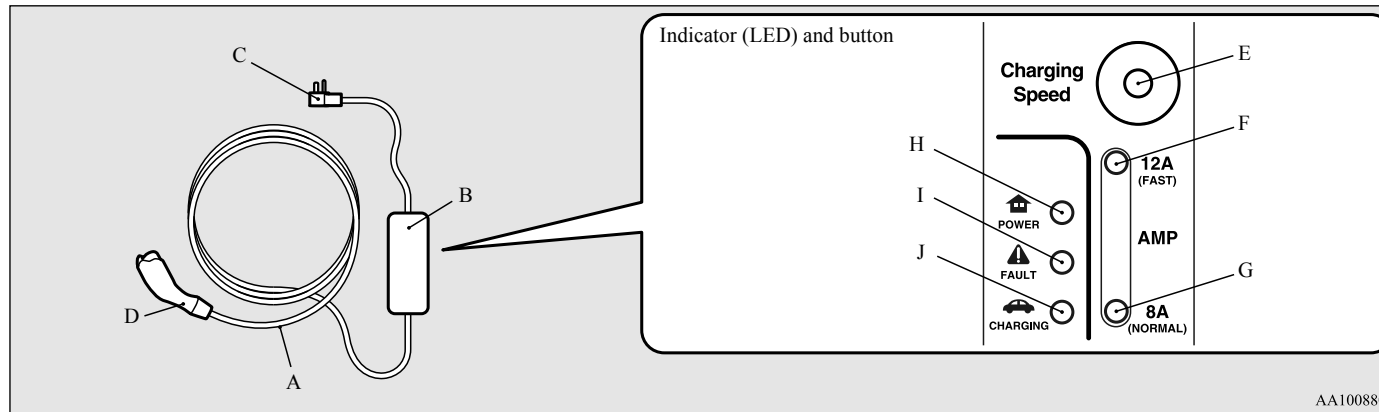

E- 8A/12A manual selection button
F- 12A indicator
G- 8A indicator

H (🏠)- POWER indicator
I (⚠️)- FAULT indicator
J (🚗)- CHARGING indicator

For a quicker charge, press the 8A/12A manual selection button (E) and confirm that the 12A indicator (F) is illuminated. Each time you press the button, either the 12A indicator or the 8A indicator (G) will illuminate.

POWER (H), FAULT (I) and CHARGING (J) indicators located on the control box will illuminate/blink in response to the following conditions:

EV charging cable

○: Illuminates ◎: Blinking ●: Not illuminated

3

POWER 🏠	FAULT ⚠️	CHARGING 🚗	Operating condition
○	○	○	Every time the charging cable plug (C) is connected to an outlet, all indicator lights illuminate for 1/2 second, then go out.
○	●	●	After initial processing is completed, when the regular charge connector is not connected to the regular charge port, or the regular charge connector is connected to the regular charge port but charging is not being performed.
○	●	○	While the main drive lithium-ion battery is being charged
◎	◎	●	When the ground cable is disconnected Check the grounding of the outlet being used. If the outlet is properly grounded, contact a certified i-MiEV dealer.
○	●	◎	When charging is completed.

POWER 🏠	FAULT ⚠️	CHARGING 🚗	Abnormal operating condition and corrective action
○	◎	●	When an electric leakage occurs or the EV charging cable malfunctions. Stop use immediately and contact a certified i-MiEV dealer.
○	○	●	When the EV charging cable malfunctions. Stop use immediately and contact a certified i-MiEV dealer.
●	●	●	If the control box indicator light does not illuminate after connecting the charging cable plug to the outlet, check the circuit breaker for the outlet. If the breaker has tripped, the circuit may not be suitable for use with EV charging cable. You should have a licensed electrician inspect and repair the electrical circuit. If the breaker is not tripped, stop using the EV charging cable and contact a certified i-MiEV dealer.

EV charging cable

WARNING

- **Improper use of the EV charging cable can result in a fire, property damage, and serious injury or death.**

Carefully read instructions regarding “Precautions during charging the main drive lithium-ion battery” on page 3-15 and on “Regular charging (charging method with rated AC 120 V outlet)” on page 3-16 and described in this section and follow them.

- Always use an outlet protected by a ground-fault circuit interrupter, rated for 15A or more, and that is connected to a dedicated branch circuit.
- Never use an extension cable or conversion adapter.
- When using a non-waterproof outlet, take care to avoid contact with rainwater during charging.
- Never connect or disconnect the plug with a wet hand.
- Make sure that the plug is inserted all the way into the socket before use. Continued charging with a plug not completely inserted or pulled halfway out of the socket may result in a risk of overheating or fire.
- If the indicators show the EV charging cable malfunctions as described below, stop using the EV charging cable and contact a certified i-MiEV dealer.
- Never disassemble the EV charging cable or attempt to open the control box.

NOTE

- All indicators are illuminated momentarily for confirming operation when the charging cable plug is inserted into an outlet. After that, the POWER indicator is continuously illuminated and the CHARGING indicator is continuously blinking.
- The CHARGING indicator will start to blink when charging is completed. The POWER indicator is continuously illuminated while charging cable plug is inserted into an outlet.

Handling and storing the control box

N01202901041

CAUTION

- Use the method shown below to help secure the control box and to prevent the plug from being pulled halfway out of the socket during charging.

NOTE

- Use hook (A) and a rope (B) that can support the weight of the EV charging cable, 8.8 lbs (4 kg) as shown in the figure below.

NOTE

- Make sure that the rope has no damage before use.

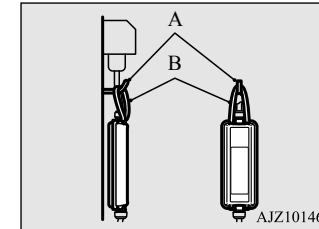
**3**

FCC Notice: This equipment has been tested and found to comply with the limits for a Class B digital device, pursuant to part 15 of the FCC Rules. These limits are designed to provide reasonable protection against harmful interference in a residential installation.

This equipment generates, uses and can radiate radio frequency energy and, if not installed and used in accordance with the instructions, may cause harmful interference to radio communications.

However, there is no guarantee that interference will not occur in a particular installation. If this equipment does cause harmful interference to radio or television reception, which can be determined by turning the equipment off and on, the user is encouraged to try to correct the interference by one or more of the following measures:

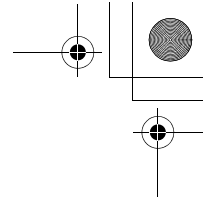
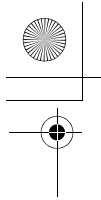

3

Regular charging (using 240 V Electric Vehicle Supply Equipment)

- Reorient or relocate the receiving antenna.
- Increase the separation between the equipment and receiver.
- Connect the equipment into an outlet on a circuit different from that to which the receiver is connected.
- Consult the dealer or an experienced radio/TV technician for help.

ICES Notice: This Class B digital apparatus complies with Canadian ICES-003.

Cleaning the EV charging cable

N01203000013

1. Gently wipe outside surface of the EV charging cable with gauze or a similar soft cloth soaked with a mild soap and water solution.
2. Wipe off all detergent with a soft cloth dipped in fresh water and thoroughly wrung out.
3. Wipe all moisture off and dry in a shaded, well-ventilated area.

! WARNING

- Before cleaning, be sure to remove the charging cable plug from the socket and the regular charging plug from the vehicle. Do not connect or disconnect the plug with a wet hand. Doing so can cause an electric shock.

! WARNING

- Never expose the metal terminal of the regular charge connector or the charging cable plug to water or neutral detergent. Water or detergent entering into the plugs can cause a fire or an electric shock.

! CAUTION

- Never use benzine, petrol, organic solvents, acid, or alkaline solvents to clean the charging cable. Doing so could cause deformation, discolour, or malfunction. Also, these substances may be present in various cleaners, so check carefully before use.

Regular charging (using 240 V Electric Vehicle Supply Equipment)

N01216101028

You can charge your vehicle through the regular charge port using 240V Electric Vehicle Supply Equipment (EVSE) compatible with i-MiEV.

Carefully read instructions on “Precautions during charging the main drive lithium-ion battery” on page 3-15, described in this section.

For connecting/disconnecting the charging connector to/from the vehicle, follow instruc-

tions for the regular charging (charging method with rated AC 120V outlet) on page 3-16. Also follow instructions provided with the 240V EVSE.

! WARNING

- Individuals using an electro-medical apparatus such as implantable pacemakers and implantable cardiovascular-defibrillators should check with the manufacturer of the apparatus to confirm the effect of the electromagnetic waves from charging. The electromagnetic waves may affect the operations of the electro-medical apparatus.
- If you use an electro-medical apparatus, such as an implantable cardiac pacemaker or an implantable cardiovascular defibrillator, observe the following precautions before charging;
 - Keep your electro-medical apparatus away from the charge connector, EV charging cable, control box and regular charging station.
 - While regular charging;
 - Do not stay inside the vehicle.
 - Do not go inside the vehicle, for example to remove or place an item in the passenger compartment.
 - Do not open the liftgate, for example to remove or place an item in the cargo area.

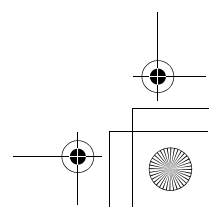
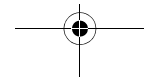
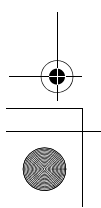
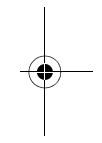
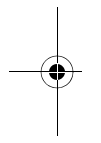

Quick charging (charging method with quick charger)

CAUTION

- Be sure to use a 240V EVSE compatible with i-MiEV. Use of a non-compatible 240V EVSE may not charge the main drive lithium-ion battery correctly or may damage the main drive lithium-ion battery.

NOTE

- The 240V EVSE compatible with i-MiEV is available separately. Contact a certified i-MiEV dealer.

Quick charging (charging method with quick charger)

N01203301039

Your vehicle is equipped with a quick charge port. The quick charge port is compatible with most CHAdeMO* connectors on charging stations.

*: CHAdeMO is a standard for quick charging of electric vehicle originally started in Japan, and the contents have become an international standard. Charging stations using this standard are UL certified and safe to use in the US.

Improper charging can result in a fire, property damage, and serious injury or death.

Carefully read and follow instructions on "Precautions during charging the main drive

lithium-ion battery" on page 3-15, instructions described in this section and also instructions for the quick charger you use.

WARNING

- Be sure to use a quick charger compatible with i-MiEV. Use of a non-compatible quick charger may cause a fire or malfunction.
- For the quick charger compatible with i-MiEV, consult an certified i-MiEV dealer.
- For operation of a quick charger, follow instructions for each quick charger.
- If you use an electro-medical apparatus, such as implantable cardiac pacemaker or an implantable cardiovascular defibrillator, follow the precautions described below. Quick charging may affect the operation of electric medical devices.
 - Do not perform quick charging and keep away from a quick charger. Electromagnetic waves produced by a quick charger may affect the operation of your electric-medical apparatus.
- If you have accidentally approached a quick charger, walk away from the quick charger immediately.
- If quick charging is necessary, ask someone for help.
- While quick charging;

WARNING

- Do not stay inside the vehicle.
- Do not go inside the vehicle, for example to remove or place an item in the passenger compartment.
- Do not open the liftgate, for example to remove or place an item in the cargo area.
- Never connect or disconnect the charger with a wet hand.
- Never pull the cable to disconnect the charger.
- During charging, the cooling fans under the hood may automatically be operated even if the electric motor switch is in the "LOCK" position. Keep your hands away from the cooling fan during charging.
- As the quick charge connector is heavier in comparison to the regular charge connector, allowing it to drop could cause damage to the vehicle or charge connector or personal injury.

3**CAUTION**

- If the charge connector cannot easily be connected to the quick charge port, do not force the connection. Foreign material may be in the charge connector or quick charge port, or the charging device may not be compatible with your vehicle. Contact a certified i-MiEV dealer.

Quick charging (charging method with quick charger)

3

NOTE

- Repeatedly performing only quick charging can reduce the battery capacity. Regular charging is recommended unless quick charging is necessary.
- Before using a publicly available quick charger, confirm that the charger is suitable for your vehicle.
- Make sure to lock the doors to prevent theft, etc. during charging.
- Do not turn the electric motor switch to the “ON” position during quick charging; doing so will stop quick charging.
- When using a quick charger, make sure that the time available is enough so that the quick charging can be finished in the time available.
If the power supply of the quick charger is shut off during quick charging, it could lead to a vehicle failure.

1. Fully apply the parking brake and move the selector lever to the “P” (PARK) position.
2. Stop the electric devices such as lamps, air conditioning, etc. and turn the electric motor switch to the “LOCK” position.
3. Pull the quick charging lid opener (A) at the bottom left of the driver’s seat to open the quick charging lid (B) at the left rear side of the vehicle.

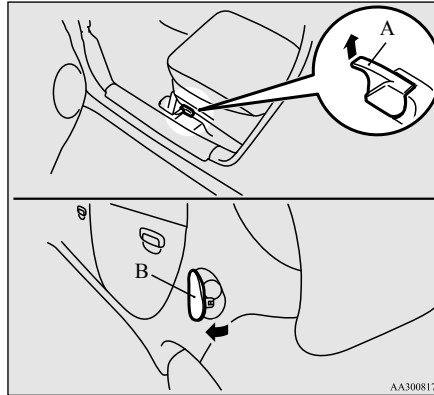

4. Remove key and lock the vehicle.
5. Press the tab (C) to open the inner lid (D).

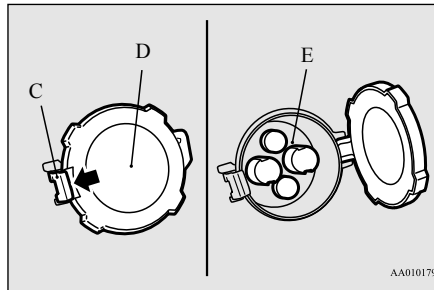

WARNING

- Do not touch the metal terminal of the quick charge port (E) and the quick charge connector. Doing so could cause an electric shock and/or malfunction.

CAUTION

- Be sure to insert the quick charge connector straight into the quick charge port all the way to the base. Failure to do so may result in the main drive lithium-ion battery not charging or cause damage to the charging equipment.
- Do not leave the inner lid open for any significant period of time without the charge connector inserted. Foreign material, if allowed to enter the quick charge port, can damage the quick charge port and/or prevent charging.

NOTE

- There is a hole on the quick charge port for water drainage. If this hole is blocked and water gets trapped in the quick charge port, do not charge. Contact a certified i-MiEV dealer.

Quick charging (charging method with quick charger)

NOTE

- If the quick charge port becomes frozen, use a hair dryer to defrost and dry it before charging. Forcing the charging connector into the quick charge port while it is frozen can damage the quick charge port, and it may prevent charging.

6. Insert the quick charge connector completely into the quick charge port to begin charging.

For connecting and disconnecting, follow the instruction manual for each quick charger.

WARNING

- **Be sure to insert the charge connector completely into the quick charge port. If the charge connector is only partially inserted and the connector latch is not locked, the electric motor switch could be turned to the “START” position and the vehicle could start moving**

7. Make sure that the charging indicator on the instrument cluster is illuminated.

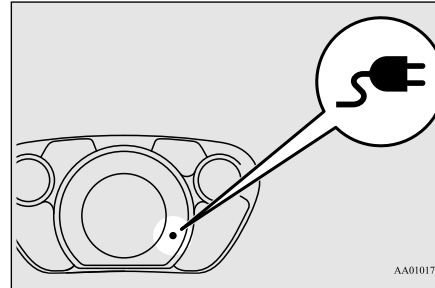

If the charging indicator is not illuminated, charging has not started. Refer to the quick charger user manual.

NOTE

- When the quick charging plug is connected to the charging connection, the charging indicator will blink. Once charging has started, the charging indicator will illuminate.

NOTE

- The charge level for the main drive lithium-ion battery can be checked with the energy level gauge (F) on the instrument cluster. Refer to “Energy level gauge” on page 5-41.

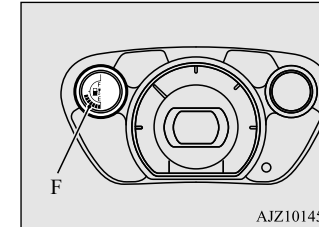

- You may hear operating sounds from the main drive lithium-ion battery cooling system, such as sounds from the cooling fan and air conditioning compressor, during quick charging. This is normal.
- Since the main drive lithium-ion battery cooling system uses cool air from the air conditioning system, the air conditioning will automatically be operated. After quick charging, you may find dehumidified water from the air conditioning system under the vehicle. This is normal.

8. Charging is complete when the charging indicator turns off.

Disconnect the quick charge connector according to the manual of the quick charger.

Quick charging (charging method with quick charger)

3

CAUTION

- Do not leave the quick charge connected to the quick charge port after charging. Someone might stumble on the charger or the quick charge port might get damaged.

NOTE

- Although it is possible to start the electric motor unit if quick charging has not finished normally, the charging indicator is continuously blinking. In such a situation, perform quick charging again and finish it normally or contact a certified i-MiEV dealer.

9. Close the inner lid and close the quick charging lid.

WARNING

- After charging, be sure to close the inner lid and the quick charging lid completely. Be careful that water or dust does not enter in the quick charge port, inner lid and quick charge connector. Entry of water or dust could cause a fire, electric shock or short circuit.

NOTE

- If the electric motor switch is turned to the “START” position with the quick charge connector connected to the quick charge port, the electric motor unit cannot be started.
Be sure to disconnect the quick charge connector before starting the electric motor unit.
- Charging may stop before full charge. This is a control for efficient charge and not a malfunction.
To achieve full charge, repeat charging from Step 5 again.
- Make sure that the inner lid is completely closed before closing the quick charging lid. If the quick charging lid is forcibly closed without first completely closing inner lid, the hinge on the inner lid may be broken.

Charging troubleshooting guide

N01202301032

3

Symptom	Possible cause	Possible solution
Charging cannot be started.	The electric motor switch is in the ON position.	Before charging, place the electric motor switch in the “LOCK” position.
	The main drive lithium-ion battery is already fully charged.	Charging cannot be performed if the main drive lithium-ion battery is already fully charged. Charging automatically turns off if the main drive lithium-ion battery is fully charged.
	The temperature of the main drive lithium-ion battery is too high or too low to charge.	Confirm the main drive lithium-ion battery temperature. Refer to “Cautions and actions to deal with intense heat” on page 3-8 and “Cautions and actions to deal with intense cold” on page 3-10.
	The 12V starter battery is discharged.	The main drive lithium-ion battery can be charged if the vehicle electrical systems cannot be turned on. If the battery is discharged, charge or jump start the 12V starter battery. Refer to “Jump-starting” on page 8-2.
	The vehicle or the charging cable has a malfunction.	The vehicle or the charging cable may have a malfunction. Confirm if the warning light on the meter is illuminated. Confirm if the indicator on the charger is indicating a malfunction. If a warning is displayed, stop charging and contact a certified i-MiEV dealer.
	The fuse has blown.	Confirm if the fuse of the interior lights (dome lights) in the fuse block in the passenger compartment located in front of the driver’s seat has blown. Refer to “Fuses” on page 9-18.

Charging troubleshooting guide

3

Symptom	Possible cause	Possible solution
Regular charging cannot be started.	There is no electrical power coming from the outlet.	Confirm that there has not been a power failure. Make sure the breaker is on. If an outlet with a timer device installed is used, power will only be available at the time set by the timer. Confirm if the POWER indicator on the control box is illuminated.
	The charge connector is not connected correctly.	Confirm the charge connector is connected correctly.
	The charge connector was connected and disconnected repeatedly in a short time.	Disconnect the charge connector, wait for a while, then start charging procedure again from the beginning.
	A charging cable for other vehicle is used.	Use the EV charging cable only for your vehicle.
	The regular charger may not be compatible with your vehicle.	Ask an administrator or the manufacturer of the regular charger whether the charger is compatible with your vehicle. Always follow the instructions shown on the regular charger.
Charging Timer by MiEV remote cannot be started.	Refer to “Action to be taken when the MiEV Remote system does not operate correctly” on page 3-52.	

Charging troubleshooting guide

Symptom	Possible cause	Possible solution
Regular charging is discontinued.	There is no power coming from the outlet.	There may have been a electrical power failure, or the breaker may have failed.Charging will resume when the power source is reset.
	The EV charging cable has been disconnected.	Check that the EV charging cable has not been disconnected.
	The button on the regular charge connector has been pressed.	If the charge connector button is pressed for a long period of time, charging will be stopped. Start the charging procedure again.
	The temperature of the main drive lithium-ion battery is too hot or too cold to charge.	Confirm the main drive lithium-ion battery temperature. Refer to “Cautions and actions to deal with intense heat” on page 3-8 and “Cautions and actions to deal with intense cold” on page 3-10.
	Charging is stopped by the regular charge timer.	Charging will stop depending on the timer function setting of the regular charge device. If you need to charge the main drive lithium-ion battery more, start the charging procedure again.
Quick charging cannot be started.	The charge connector is not connected correctly and/or not locked.	Check that the charge connector is connected correctly and that it is locked.
	The self-diagnostic function of the quick charge device returns a negative result.	There is a possibility that the vehicle has a malfunction. Stop charging and contact a certified i-MiEV dealer.
	The power switch of the quick charger is off.	Check the power switch of the quick charger. Consult an administrator or a maker of the quick charger.
Quick charge is discontinued.	Charging is stopped by the quick charge timer.	Charging will stop depending on the timer function setting of the quick charge device.If you need to charge the main drive lithium-ion battery more, start the charging procedure again.
	Charging stops at 80% capacity.	Charging is designed to stop when the main drive lithium-ion battery capacity reaches 80%. If you need to charge the main drive lithium-ion battery more than 80%, start the charging procedure again.
	The power supply for the quick charger is off.	Check whether the power supply for the quick charger is off. Consult an administrator or a maker of the quick charger.

3

High-Voltage components

3

Symptom	Possible cause	Possible solution
The charging indicator is continuously blinking even if the quick charge connector is not connected into the quick charge port when you start the electric motor unit after quick charging.	Quick charging has not finished normally.	Perform quick charging again and finish it normally or contact a certified i-MiEV dealer.
EV (Electric Vehicle) system does not start after quick charging.	The vehicle has a malfunction.	Contact a certified i-MiEV dealer. If you need to push the vehicle, turn the electric motor switch to the “ON” position and move the selector lever to the “N”(NEUTRAL) position.

High-Voltage components

N01205700027

⚠ WARNING

● The EV (Electric Vehicle) system uses high voltage up to DC 330 volt. The system can be hot during and after starting and when the vehicle is shut off. Be careful of both the high voltage and the high temperature. Follow the warning labels that are attached to the vehicle.

⚠ WARNING

- Never touch, disassemble, remove or replace high-voltage parts, exposed electrical components, cables or connectors. Failure to follow this instruction can result in severe burns or electric shock causing serious injury or death. High-voltage cables are colored orange. The vehicle high voltage system has no user serviceable parts. Take your vehicle to a Certified i-MiEV dealer for any necessary maintenance.
- Always assume the high voltage battery and associated components are energized and fully charged.

High voltage components and wiring cables are located as shown in the figure below.

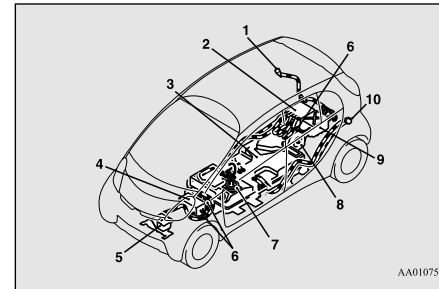

AA0107574

- 1- Regular charge port
- 2- MCU
- 3- Main drive lithium-ion battery
- 4- Heater
- 5- Air conditioner compressor
- 6- High voltage connector
- 7- Service plug
- 8- Electric motor (Electric motor unit)
- 9- On board charger/DC-DC converter

10- Quick charge port

In case of a collision

N01205800031

A crash or impact significant enough to require an emergency response for conventional vehicles would also require the same response for electric vehicles.

Also follow the instructions described below to avoid severe burns and electrical shock that may result in serious injury or death.

WARNING

- If your vehicle is drivable, pull your vehicle off the road to a safe, nearby location and remain on the scene.
- Also, if possible, do the following operations and stay out of the way of any oncoming traffic while awaiting the arrival of emergency responders.
 - Apply chocks to the wheels.
 - Move the selector lever to the “P” (PARK) position.
 - Apply the parking brake.
 - Open the windows, doors and liftgate.
 - Turn the electric motor switch to the “LOCK” position.
 - Turn on the hazard warning flashers.
 - Move the key away from the vehicle to prevent unintended start-up of the system by inadvertent contact with a switch or impact from the crash.

WARNING

- Never touch high-voltage wiring, connectors, and other high-voltage parts, such as the inverter unit and main drive lithium-ion battery. An electric shock may occur if exposed electric wires are visible when viewed from inside or outside of your vehicle. For their locations, see “High-voltage components” on page 3-34.
- If the vehicle receives a strong impact to the floor while driving, stop the vehicle in a safe place and check the floor.
- Leaks or damage to the main drive lithium-ion battery may result in a fire. If you discover them, contact emergency services immediately. Since the fluid leak may be lithium manganite from the Lithium-ion battery, never touch any fluid leaking from the inside or outside of the vehicle. If the fluid contacts your skin or eyes, wash it off immediately with a large amount of water and receive immediate medical attention to help avoid serious injury.
- If you are unable to safely assess the vehicle due to vehicle damage, do not touch the vehicle. Leave the vehicle and contact emergency services. Advise emergency responders that this is an electric vehicle.

WARNING

- If a fire occurs in this vehicle, leave the vehicle as soon as possible and contact emergency services. Do not attempt to extinguish a fire by yourself. If the fire involves a lithium-ion battery, it will require large, sustained volumes of water for extinguishment. Using a small amount of water or the incorrect fire extinguisher can result in serious injury or death from electrical shock.
- When you leave the vehicle, if possible, open the windows, doors and liftgate to prevent accumulation of poisonous/combustible gasses. This will also assist in the rescue and fire fighting process.
- As with any vehicle fire, the byproducts of combustion can be toxic. Do not inhale smoke, vapors, or gas from the vehicle. Move to a safe distance upwind and uphill from the vehicle fire and out of the way of any oncoming traffic while awaiting the arrival of emergency responders.
- If you detect leaking fluids, sparks, smoke, flames, gurgling, popping or hissing noises originating from the high voltage battery compartment, contact emergency services immediately. This may result in a fire.
- Physical damage to the vehicle or high voltage battery may result in immediate or delayed release of toxic and/or flammable gases and fire.

3

MiEV Remote System

3

WARNING

- If your vehicle needs to be towed, transport the vehicle on a flatbed truck or tow the vehicle either with all wheels or the rear wheels (drive wheels) off the ground. If the rear wheels are on the ground when towing, this may cause damage to the electric motors. This may also cause a fire, if wiring in the electric motor unit room becomes damaged. Refer to “Towing” on page 8-11.
- Do not attempt to repair a damaged electric vehicle yourself. Please contact a certified i-MiEV dealer for service.
- In the event of an accident that requires body repair and painting, the vehicle should be delivered to a Certified i-MiEV dealer to have the main drive lithium-ion battery and high voltage parts such as the inverter, including the attached wiring harness, removed prior to painting. If exposed to heat in the paint booth, the main drive lithium-ion battery will experience battery capacity loss. A damaged main drive lithium-ion battery can also pose safety risks to untrained mechanics and repair personnel.

NOTE

- The emergency shut-off system will be activated and the high-voltage system will automatically turn off under the following conditions:

NOTE

- Certain front, side or rear collisions.
- Certain EV (Electric Vehicle) system malfunctions.
- When the emergency shut-off system is activated, the ready indicator is turned off. Refer to “Indicator and warning light package” on page 5-43.
- If the emergency shut-off system activates, contact a Certified i-MiEV dealer.

MiEV Remote System

N01203401056

The MiEV Remote System has the following three functions.

- Charging Timer → P.3-41
When the EV charging cable (regular charger) (Level 1 or Level 2) is connected, the batteries will only charge during the pre-set time period selected using the MiEV Remote.
- Remote Climate Control → P.3-47
When the EV charging cable (regular charger) (Level 1 or Level 2) is connected, the air-conditioner or heater can be activated for up to 30 minutes prior to vehicle usage. This feature can be used to cool or heat the car and to activate the front and rear window defroster.

COOL: Operates in cooling mode intended for exclusive use with Remote Climate Control (Pre-Cooling Mode).

HEAT: Operates in heating mode intended for exclusive use with Remote Climate Control (Pre-Heating Mode). The heated seats can be used while the Remote Climate Control is activated.

: Operates in defroster mode intended for exclusive use with Remote Climate Control (Pre-Defroster Mode). The electric rear window defogger is activated automatically when the Remote Climate Control is activated in Pre-Defroster Mode.

- Main Drive Lithium-ion Battery Level Indicator → P.3-50
The charge remaining in the Main Drive Lithium-ion Battery can be confirmed through the MiEV Remote.

For your quick reference, refer to “Basic operation of the MiEV Remote” on page 3-40.

MiEV Remote System

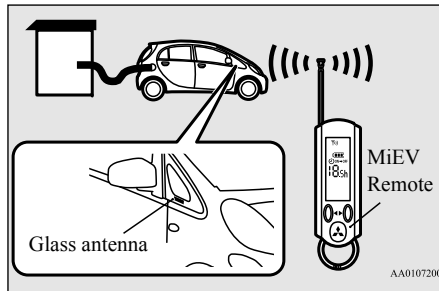

AA0107200

WARNING

- Individuals who use implantable pacemakers or implantable cardiovascular-defibrillators should keep away from the external and internal transmitters. The electromagnetic waves used in the MiEV Remote System may affect the operation of implantable pacemakers and implantable cardiovascular-defibrillators.
- Individuals using other electro-medical apparatus besides implantable pacemakers and implantable cardiovascular-defibrillators should check with the manufacturer of the apparatus to confirm the effect of the electromagnetic waves used by the MiEV Remote System. The electromagnetic waves may affect the operations of the electro-medical apparatus.
- Never use the MiEV Remote near medical equipment. Electromagnetic waves could adversely affect the medical equipment.

WARNING

- Keep the MiEV Remote in the place where children will not touch or play with the remote.
- When bringing the MiEV Remote on flights, do not press any switches on the MiEV Remote while on the plane. If a switch is pressed on the plane, the MiEV Remote emits electromagnetic waves which like cell phones and other wireless devices, could interfere with systems on the airplane.
When carrying the MiEV Remote in a bag, be careful that no switches on the MiEV Remote can be pressed by mistake.

CAUTION

- Never disassemble or modify the MiEV Remote. No user serviceable parts are inside except batteries.
- Disassembling or modifying the MiEV Remote or removing a label from the MiEV Remote may violate regulations.

NOTE

- The MiEV Remote system uses radio waves. The MiEV Remote can operate within approximately 328 feet (100 m) from the vehicle.
- In the following environments or situations, the MiEV Remote may not transmit and receive radio waves correctly. As a result, the remote may not operate properly.
- When the vehicle and the MiEV Remote are separated by a concrete wall.
 - When there is a metal wall between the vehicle and the MiEV Remote.
 - When the vehicle is surrounded by other tall vehicles.
 - When the vehicle and/or the MiEV Remote is near a facility emitting strong radio waves, such as a television tower, a transformer substation, a broadcasting station or an airport.
 - When other electrical equipment such as computers or cell-phones are placed near the MiEV Remote.
 - When the MiEV Remote touches something metallic, or is covered by a metal object.
 - When batteries for the MiEV Remote are weak.
 - Melody and buzzer from the MiEV Remote can be turned on or off. Refer to "To turn on/off melody and buzzer" on page 3-49.

3

MiEV Remote System

3

NOTE

- The transmitter signal will reach further when the antenna of the MiEV Remote is fully extended and held upright.
- The onboard antenna is printed on the right side delta glass of the vehicle.
- When the MiEV Remote is not used for more than 30 seconds, the MiEV Remote will automatically turn off.
- Some charge facilities have a timer function which turns the power supply on and off automatically. When using a charge facility with this timer function, please adjust the charging time set by the MiEV Remote to be consistent with the timer used by the charging facility.
- When you need additional MiEV Remotes, please contact a certified i-MiEV dealer. Up to four MiEV Remotes can be used per vehicle.
- You may hear operating sounds such as sounds from the cooling fan and air conditioning compressor when the Remote Climate Control is activated even if the electric motor switch is in "LOCK" position during timer charging. This is normal. Refer to "Remote Climate Control" on page 3-47.

MiEV Remote

N01203501044

Switches

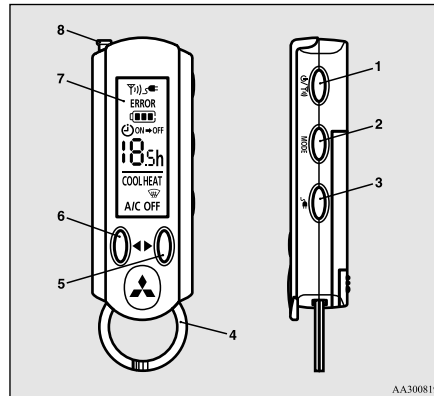

AA3008193

- 1- Power/communication switch - Press and hold to turn remote on. Press quickly to transmit command to vehicle.
- 2- MODE switch - The display of the MiEV Remote is changed in order of "ON timer", "OFF timer" and "Remote Climate Control" by pressing this switch.
- 3- Manual charge switch (this can also cancel the timers and Remote Climate Control).
- 4- Ring

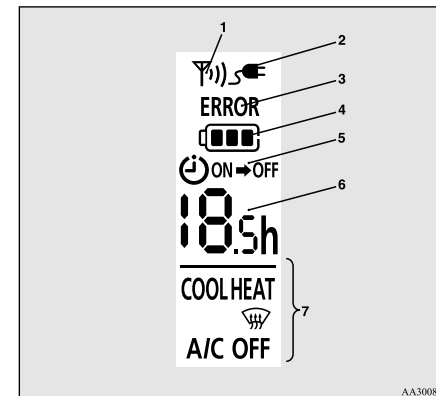

- 5- UP switch - scrolls up the display items
- 6- DOWN switch - scrolls down the display items
- 7- Display
- 8- Antenna

Display (LCD monitor)



AA3008207

- 1- Blinks when communicating with vehicle, and when error occurs.
- 2- The indicator lights up during charging. The indicator blinks when the manual charging button is pressed. The indicator will rapidly blink, if EV charging cable (regular charger) is not connected when the timer charging or Remote Climate Control is set.

- 3- Blinks if there is an operation or communication error.
- 4- Shows remaining charge of the Main Drive Lithium-ion Battery. Blinks if battery has less than 20% charge.
- 5-  ON: Indicates ON timer is set
 ON → OFF: Indicates OFF timer is set
- 6- Indicates amount of time until Charging Timer is complete.
- 7- When Remote Climate Control is set, displays mode set to operate:
COOL: Pre-Cooling Mode
HEAT: Pre-Heating Mode
: Pre-Defroster Mode
A/C OFF: Remote Climate Control OFF

 **CAUTION**

- Never leave the MiEV Remote in a place where it will be subject to high temperatures, such as in direct sunlight, or subject to extreme low temperatures.
The MiEV Remote can be damaged and may not properly operate.
- Never drop or hit the MiEV Remote. Do not apply force to bend the antenna. These can cause damage to or failure of the remote.
- If the MiEV Remote gets wet, please wipe water off immediately. Water entering the MiEV Remote can cause a failure.

MiEV Remote System

Basic operation of the MiEV Remote

N01206100015

3

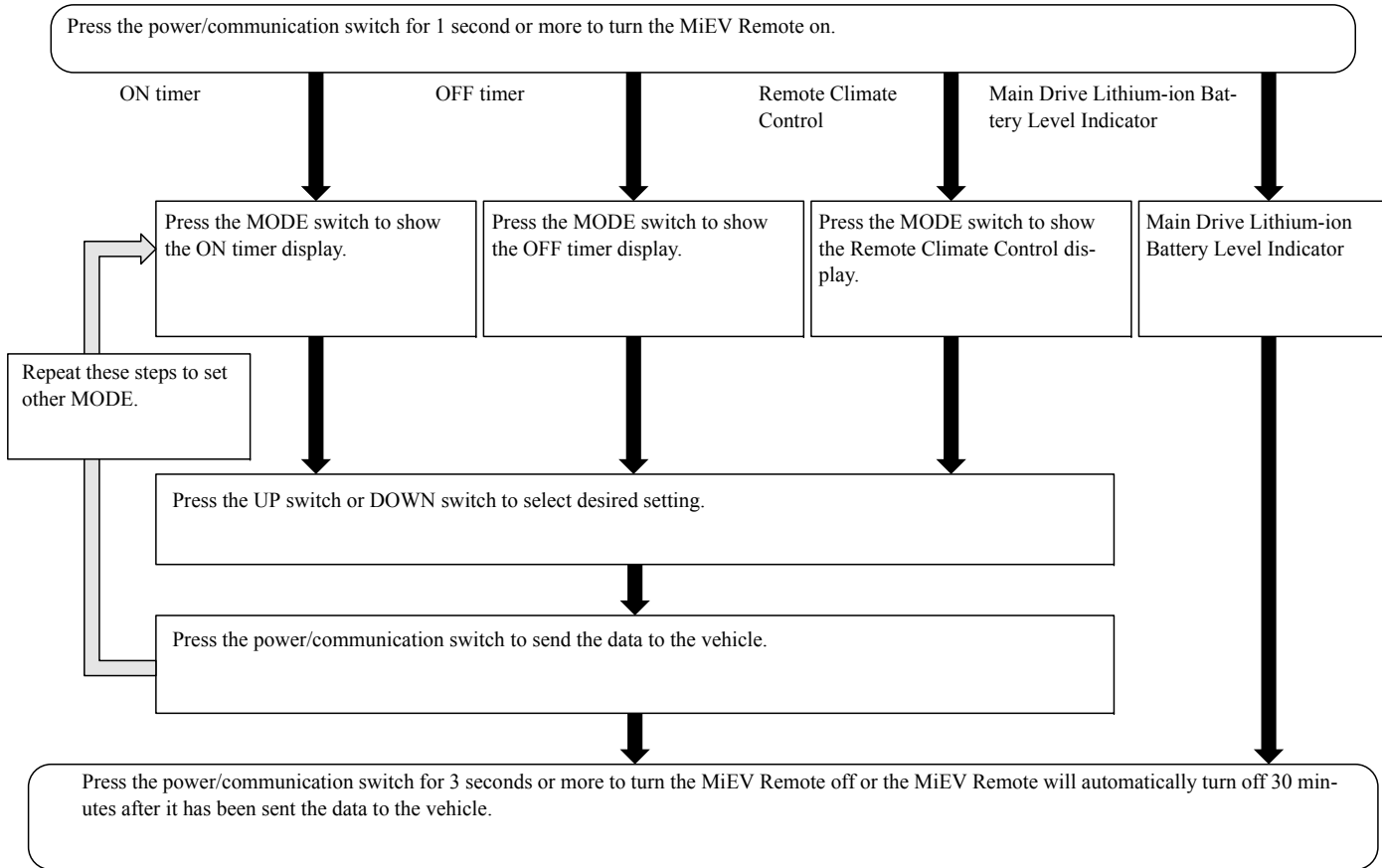

Charging Timer

N01203701020

The Charging Timer can be set as follows.

- ON timer: Time from the present to when charging will begin.
- OFF timer: Time from the start of charging to the end of charging

To set the timer, the following conditions must be met.

- Selector lever: "P" (PARK) position
- Electric motor switch: "LOCK" position
- EV charging cable (regular charger): Connected

WARNING

- Improper charging can result in a fire, property damage, and serious injury or death.

Before Charging Timer, carefully read and follow the instructions in "Precaution on Charging the Main Drive Lithium-ion Battery" on page 3-15 and "Regular charging (charging method with rated AC 120 V outlet)" on page 3-16.

NOTE

- Charging Timer cannot be used with a quick charging system.

MiEV Remote System

Example of Charging Timer

N01205001030

3

1. In case you set the timer at 9:00 PM so that charging starts at 11:00 PM and stops at 7:00 AM of the following day (for 8 hours).
2. In case you set the timer at 7:00 PM so that charging starts and stops at the same time the last time.

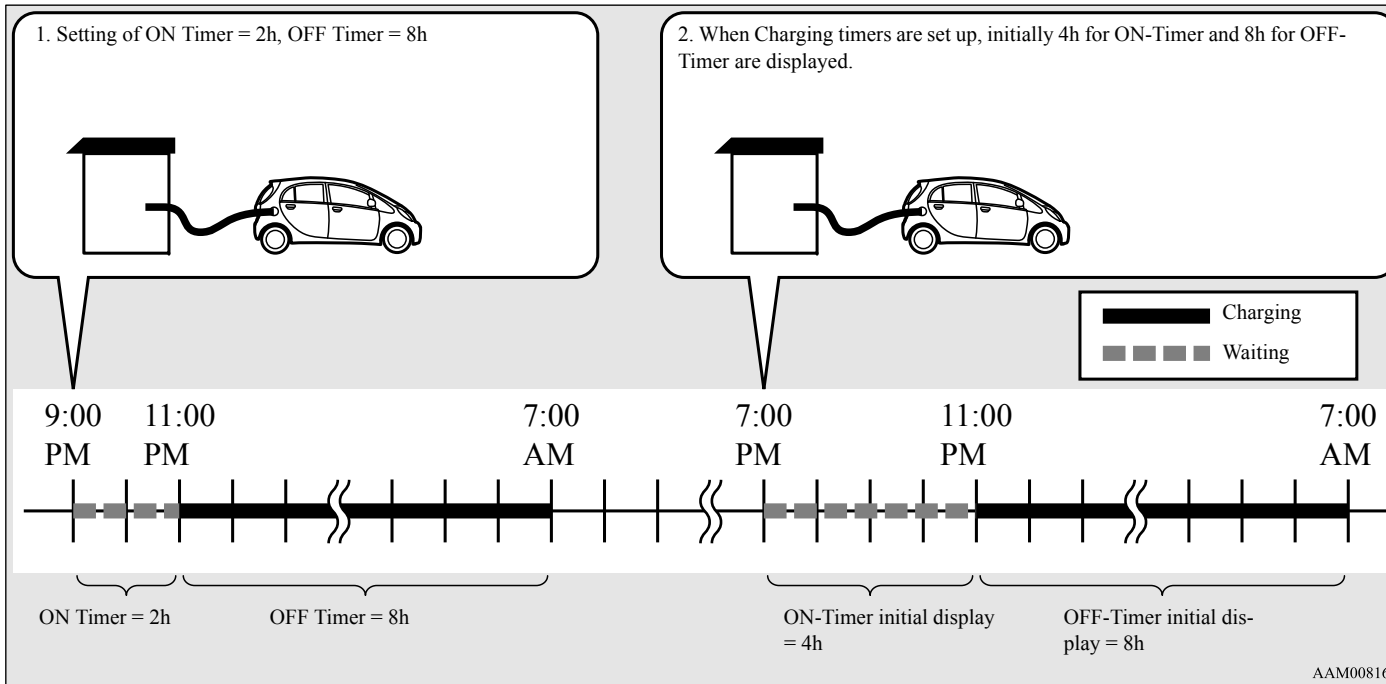

MiEV Remote System

To turn the MiEV Remote ON/OFF

N01205100018

1. Extend the antenna (A) and press the power/communication switch (B) for 1 second or more to turn the MiEV Remote on. When it communicates with the vehicle properly, the vehicle information will be displayed on the screen.

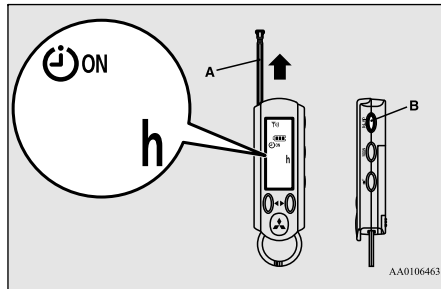

2. To turn the MiEV Remote off, press the power/communication switch (B) for 3 seconds or more and store the antenna (A).

To set the ON timer

N01205201029

1. Start the regular charging. Refer to “Regular charging (charging method with rated AC 120 V outlet)” on page 3-16.

2. Turn on the MiEV Remote. Refer to “To turn the MiEV Remote ON/OFF” on page 3-43.
3. Press the UP switch (C) or the DOWN switch (D) once. The time remaining from the present to the time that was previously set for the ON timer will be displayed and blink.

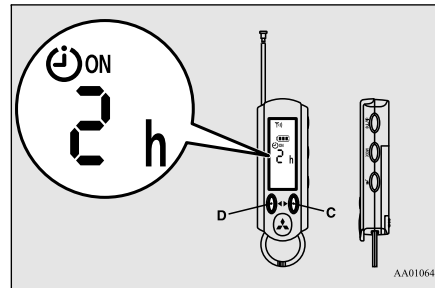

NOTE

- The remaining time for the last charging is displayed with blinking as follows.
Example: If you set the charging starting time to 11:00 PM of the day before:

Present time	Remaining time	Display
9:00 PM	2:00	2h
9:10 PM	1:50	2h
9:40 PM	1:20	1.5h

NOTE

- If the MiEV Remote cannot communicate with the vehicle, the remaining time will not be displayed.

3

4. If you need to change the remaining time for the ON timer, press the UP switch (C) or the DOWN switch (D) to change the remaining time.
The remaining time can be changed within the range from 0 to 19.5 hours in half hour increments.

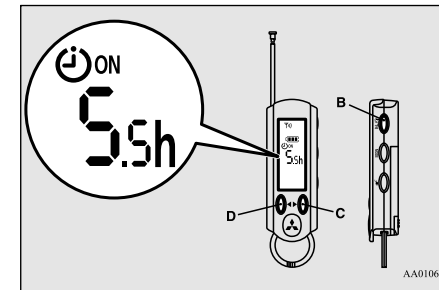

NOTE

- When you want to start the charging at the same time as the last time, changing the remaining time is unnecessary.
- When the remaining time is set to 0h, the charging starts immediately after step 5.

MiEV Remote System

3

- Press the power/communication switch (B) for less than 1 second to send the setting data to the vehicle.
The MiEV Remote will sound melodies on transmission and reception.

NOTE

- The melodies can be turned off. Refer to “To turn on/off melody and buzzer” on page 3-49.
- If a communication error occurs or the MiEV Remote System is not functioning properly, the buzzer will sound. Refer to “Display of MiEV Remote during communicating with vehicle” on page 3-46.
- If the OFF Timer is unset when setting the ON timer, the OFF timer will be automatically set with “fully charged”.
- To set OFF Timer, refer to “To set OFF Timer” on page 3-45.

- To turn off the MiEV Remote, refer to “To turn the MiEV Remote ON/OFF” on page 3-43.

NOTE

- The energy level gauge (E) in the instrument panel on the vehicle will illuminate and the charging indicator (F) will blink approximately 30 seconds after the vehicle has received the setting for the ON timer. After approximately 30 seconds, the energy level gauge and the charging indicator will go off, and the vehicle will be prepared for the Charging Timer.

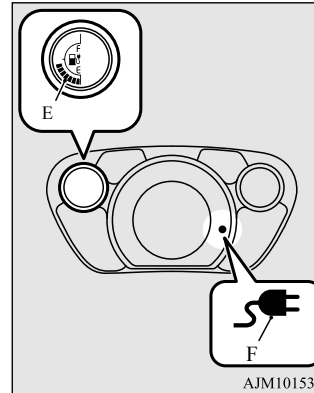

- Turning the electric motor switch to the “ON” position or the “ACC” position will cancel the Charging Timer.
- If the MODE switch is pressed while changing the ON timer setting, the change will be canceled.
- The  symbol on the MiEV Remote will be illuminated while the vehicle is charging.

NOTE

- If the charge connector is disconnected before the time set by the ON timer, the Charging Timer is not canceled. If the charge connector is re-connected again before starting the charge or setting the charge timers, the Charging Timer will resume.

To start the charging immediately after the ON timer has been set

N0120600014

- Turn on the MiEV Remote. Refer to “To turn the MiEV Remote ON/OFF” on page 3-43.
- Press the UP switch (C) or the DOWN switch (D) once, and the remaining time from the present to the time set for the ON timer will be displayed and blink.

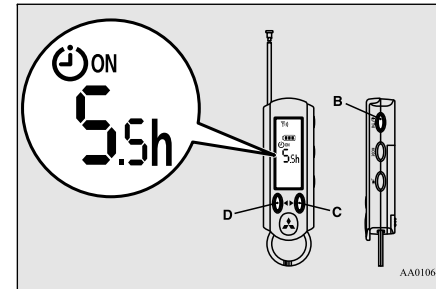

- Change the remaining time to 0h by pressing the UP switch (C) or the DOWN switch (D).

MiEV Remote System

4. Press the power/communication switch (B) for less than 1 second to send the setting data to the vehicle. The MiEV Remote will sound melodies on transmission and reception. The charging will start.

Refer to “Regular charging (charging method with rated AC 120 V outlet)” on page 3-16.

5. Turn off the MiEV Remote. Refer to “To turn the MiEV Remote ON/OFF” on page 3-43.

To set OFF Timer

N01205301033

The OFF timer can be set during the regular charging or after setting the ON timer.

1. When the power of MiEV Remote is off, turn the power on. Refer to “To turn the MiEV Remote ON/OFF” on page 3-43.
2. Press the MODE switch (G) to change the display to the OFF timer (2).

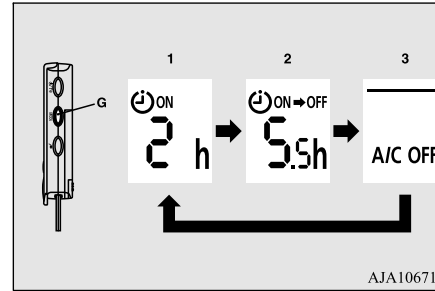

- 1_ Shown the ON timer
- 2_ Shown the OFF timer
- 3_ Shown the Remote Climate Control

3. Press the UP switch (C) or the DOWN switch (D) once. The time set last time for the OFF timer will be displayed and blink.

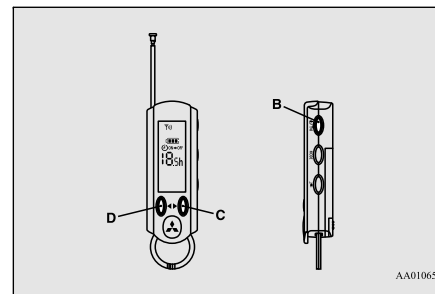

4. If you need to change the time for the OFF timer, press the UP switch (C) or the DOWN switch (D) to change the time.

- The time can be changed within the range from 0.5h to 19.5h by half hour and can be changed to “-h”.
- When “-h” is displayed, the charging will end when Main Drive Lithium-ion Battery is fully charged.

3

NOTE

- To display “-h”, press the UP switch (C) when 19.5h is displayed or press DOWN switch (D) when 0.5h is displayed.

5. Press the power/communication switch (B) for less than 1 second to send the setting data to the vehicle. The MiEV Remote will sound melodies on transmission and reception.

NOTE

- The melodies can be turned off. Refer to “To turn on/off melody and buzzer” on page 3-49.
- If a communication error occurs or the MiEV Remote System is not functioning properly, the buzzer will sound. Refer to “Display of MiEV Remote during communicating with vehicle” on page 3-46.
- If the ON timer is unset when setting the OFF timer, the ON timer will be automatically set with “0h”.

MiEV Remote System

6. Turn off the MiEV Remote. Refer to “To turn the MiEV Remote ON/OFF” on page 3-43.

3

NOTE

- The energy level gauge (E) in the instrument panel will illuminate and the charging indicator (F) will blink approximately 30 seconds after the vehicle has received the setting for the OFF timer.

After approximately 30 seconds, the energy level gauge and the charging indicator will then go off, and the vehicle will be prepared for Charging Timer in accordance with the ON/OFF setting.

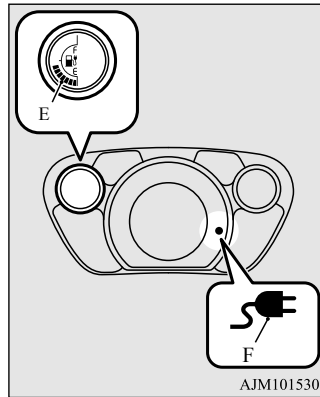

- The  symbol on the MiEV Remote illuminates while the Main Drive Lithium-ion Battery is charging.

NOTE

- The Charging Timer will be cancelled if the electric motor switch is turned to the “ON” or “ACC” position.
- Once the Main Drive Lithium-ion Battery is fully charged, the charging will end even if before the time set by the OFF timer.
- If the charge connector is disconnected during charging, the OFF charging timer will be canceled.

Display of MiEV Remote during communicating with vehicle

N01203801021

It communicates with the vehicle when the power of the MiEV Remote is turned on with pressing the power supply/communication switch (B) for 1 second or more and if the power supply/communication switch (B) is pressed for less than 1 second while the power of the MiEV Remote is on.

If the normal reception melody sounds after the transmitting melody, it is set completion. Communication symbol (H) blinks while communicating with the vehicle.

If the buzzer sounds with ERROR symbol (I) blinks, a problem is detected. Refer to “Actions to be taken when the MiEV Remote system does not operate correctly” on page 3-52.

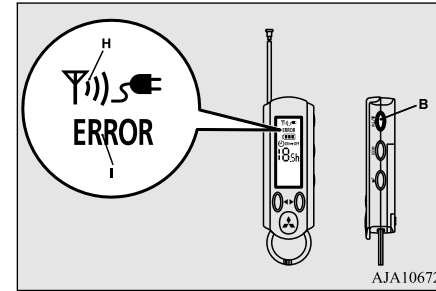

To cancel Charging Timer

N01203901022

There are two methods to cancel Charging Timer.

- By using the MiEV Remote
- By operating the electric motor switch on the vehicle

NOTE

- If the Charging Timer is canceled during charging, the charging will continue until the Main Drive Lithium-ion Battery is fully charged.
- If the Charging Timer is canceled before charging starts, charging will start immediately and continue until the Main Drive Lithium-ion Battery is fully charged.

MiEV Remote System

NOTE

- Charging Timer cannot be canceled by disconnecting the charge connector before the time set by the ON timer. The Charging Timer will resume when the charging connector is again connected to the vehicle.

A. By using the MiEV Remote

1. When the power of MiEV Remote is off, turn the power ON. Refer to “To turn the MiEV Remote ON/OFF” on page 3-43.
2. Press the manual charging switch (J), then press the power/communication switch (B) for less than 1 second.

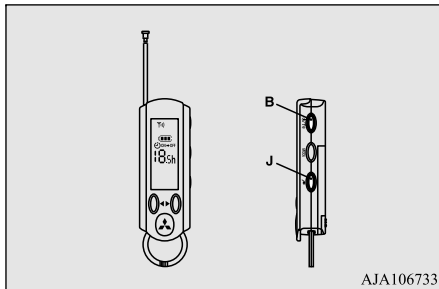

NOTE

- If the manual charging switch (J) is pressed, the  symbol of MiEV Remote will blink. Remote Climate Control is also stopped.

3. Canceling Charging Timer is complete, and the MiEV Remote will sound two different melodies.

4. Turn off the MiEV Remote. Refer to “To turn the MiEV Remote ON/OFF” on page 3-43.

B. By operating the electric motor switch on the vehicle

Turn the electric motor switch to the “ACC” or “ON” position, then turn back to the “LOCK” position.

Canceling the Charging Timer is now complete.

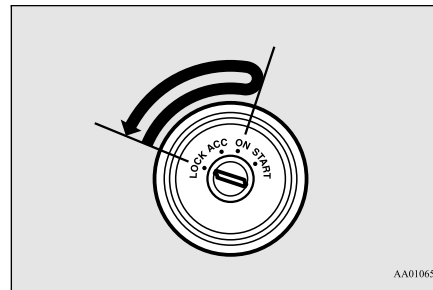

Remote Climate Control

N01204201035

WARNING

- **The Remote Climate Control, even when set, cannot be relied upon to maintain safe vehicle cabin temperatures while the vehicle is stopped or parked. Never leave children or persons requiring supervision/nursing unattended inside the vehicle. Temperature inside the vehicle could become extremely high or low resulting in a risk of heat stroke or hyperthermia that could result in death. In addition, children can activate switches and controls, resulting in an injury or fatal accident.**
- **While the Remote Climate Control is activated, keep away from the cooling fan under the front hood, since the cooling fan may automatically operate even if the electric motor switch is in the “LOCK” position.**

3

NOTE

- The Remote Climate Control works regardless the position of the air conditioning switch or dial on the vehicle. While the Remote Climate Control is activated, the air conditioning switch or dial on the vehicle will not affect operation of the cooler, heater or defroster.

MiEV Remote System

3

NOTE

- The Remote Climate Control will automatically stop 30 minutes after the Remote Climate Control has been set.
- The Remote Climate Control is operated by electric power supplied through the EV charging cable (regular charger).
- Under the following conditions, the effect of the Remote Climate Control can be decreased.
 - When the outside temperature is very high.
 - When the sunlight is strong.
 - When the outside temperature is very low.
- When Remote Climate Control is activated while charging the Main Drive Lithium-ion Battery, the time required to fully charge the Main Drive Lithium-ion Battery will become longer or the amount of charge may decrease if the OFF timer has been set.
- If the Main Drive Lithium-ion Battery Warming System is operated while the Remote Climate Control is activated, the Remote Climate Control will stop. When the Main Drive Lithium-ion Battery Warming System stops, the Remote Climate Control will resume. Refer to “Main Drive Lithium-ion Battery Warming System” on page 3-21.
- While the Remote Climate Control is activated, if a heated seat switch is ON, the heated seat will operate.

To operate the Remote Climate Control

N01204301036

The following conditions must be met to operate the Remote Climate Control.

- Selector lever: P (PARK) position.
- Electric motor switch: LOCK position.
- EV charging cable (regular charger): Connected.
- Quick charging: Not used.
- Main Drive Lithium-ion Battery Level Indicator: Shows one bar or more. Refer to “Main Drive Lithium-ion Battery Level Indicator” on page 3-50.
- All doors and the liftgate: Closed.

WARNING

- **Improper charging can result in a fire, property damage, and serious injury or death.**
Carefully read and follow instructions in “Precaution during Charging the Main Drive Lithium-ion Battery” on page 3-15 and “Regular charging (charging method with rated AC 120 V outlet)” on page 3-16.

1. Start charging. Refer to “Regular charging (charging method with rated AC 120 V outlet)” on page 3-16.

2. Turn on the MiEV Remote. Refer to “To turn the MiEV Remote ON/OFF” on page 3-43.
3. Press the MODE switch (G) to change the mode to Remote Climate Control (3).

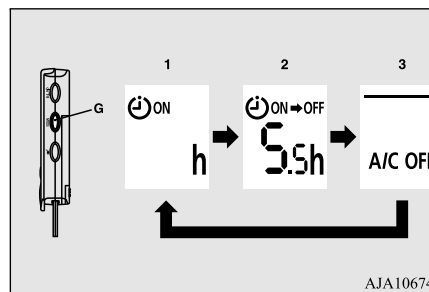

- 1_ Shown the ON timer
- 2_ Shown the OFF timer
- 3_ Shown the Remote Climate Control

4. Select a desired mode by pressing UP switch (C) or DOWN switch (D).

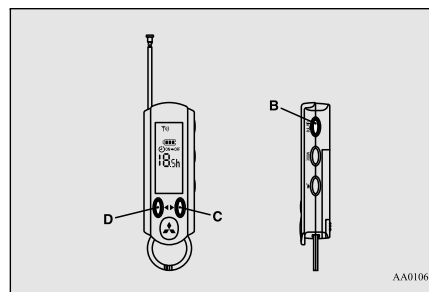

MiEV Remote System

The modes will be changed in the order from 1 to 4 by pushing the UP switch.

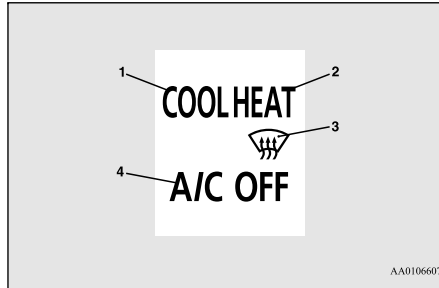

- 1_ COOL: Pre-Cooling Mode
- 2_ HEAT: Pre-Heating Mode
- 3_ : Pre-Defroster Mode
- 4_ A/C OFF: Remote Climate Control OFF

5. Press the power/communication switch (B) for less than 1 second to send the setting to the vehicle. The MiEV Remote will sound melodies on transmission and reception.

NOTE

- The melodies can be turned off. Refer to “To turn on/off melody and buzzer” on page 3-49.

NOTE

- If a communication error occurs or the MiEV Remote System is not functioning properly, the buzzer will sound. Refer to “Display of MiEV Remote during communicating with vehicle” on page 3-46.

6. Turn off the MiEV Remote. Refer to “To turn the MiEV Remote ON/OFF” on page 3-43.

To stop the Remote Climate Control

N01204401024

The Remote Climate Control can be stopped by either of the following methods.

A. By using the MiEV Remote, after pressing the manual charging switch (J), press the power/communication switch (B) for less than 1 second.

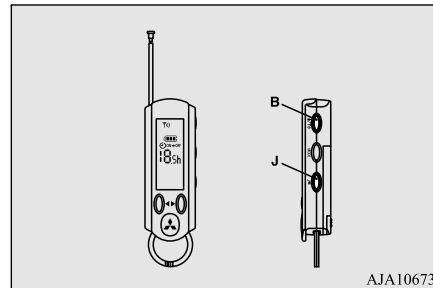

AJA106733

- B. By using the MiEV Remote, select the A/C OFF mode and send the setting. Refer to “To operate the Remote Climate Control” on page 3-48.
- C. Turn the electric motor switch to the “ACC” or the “ON” position.
- D. Disconnect the regular charge connector from the vehicle.

3

NOTE

- The Remote Climate Control will not stop if the doors or liftgate are opened after the Remote Climate Control has started.

To turn on/off melody and buzzer

N01204100024

1. Turn on the MiEV Remote. Refer to “To turn the MiEV Remote ON/OFF” on page 3-43.
 - To turn off the sounds, press the UP switch (C) while pressing MODE switch (G).
 - To turn on the sounds, press the DOWN switch (D) while pressing MODE switch (G).

MiEV Remote System

3

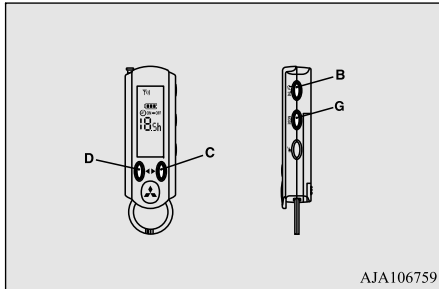

2. Turn off the MiEV Remote. Refer to “To turn the MiEV Remote ON/OFF” on page 3-43.

Main Drive Lithium-ion Battery Level Indicator

N01204500015

The remaining energy in the Main Drive Lithium-ion Battery can be checked using the MiEV Remote.

1. If the MiEV Remote has been turned off, turn on the MiEV Remote. Refer to “To turn the MiEV Remote ON/OFF” on page 3-43.
2. Current remaining energy in the Main Drive Lithium-ion Battery is shown on the display while the MiEV Remote is ON.

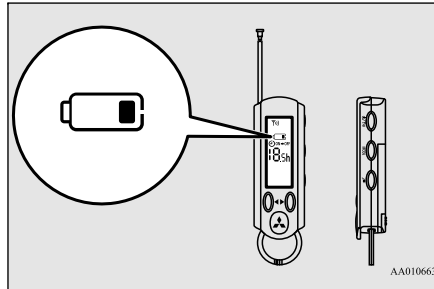

The remaining energy is shown by the number of segments displayed.

- : 3 segments: Full or near full
- : 2 segments: Moderate
- : 1 segment: Low
- : 0 segments: Empty or near empty

NOTE

- More than remained quantity in the Main Drive Lithium-ion Battery is necessary to operate the Remote Climate Control.

3. Turn off the MiEV Remote. Refer to “To turn the MiEV Remote ON/OFF” on page 3-43.

General information

N01205400011

Your MiEV Remote System operates on a radio frequency subject to Federal Communications Commission (FCC) Rules (For vehicles sold in U.S.A.) and Industry Canada Rules (For vehicles sold in Canada). This device complies with Part 15 of the FCC Rules and RSS-Gen of the Industry Canada Rules.

Operation is subject to the following two conditions.

- This device may not cause harmful interference.
- This device must accept any interference received, including interference that may cause undesired operation.

CAUTION

- Changes or modifications not expressly approved by the manufacturer for compliance could void the user’s authority to operate the equipment.

Replacement of batteries for the MiEV Remote

N0120460016

CAUTION

- MiEV Remote is a precision electronic device with a built-in signal transmitter. Do not disassemble or touch an internal parts. Keep away from water or dust.
- Be careful not to break the tab on the battery cover when removing or installing the battery cover.

About battery

N0120470017

Two coin type batteries are used. Replace as necessary to assure proper operation.

NOTE

- Standard battery life on the MiEV Remote is about 1 year. Battery life can vary depending on environmental and usage conditions.

To replace the batteries

N0120480021

1. Before replacing the batteries, remove static electricity from your body by touching a metal grounded object.
2. Battery cover (B) lifts when the slide portion (A) is moved to the arrow direction.

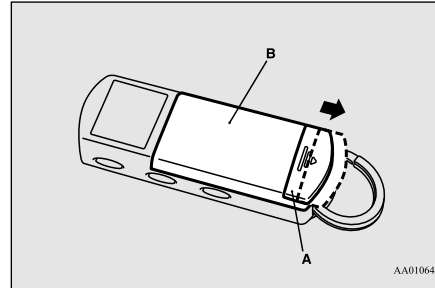

3. By moving the battery cover (B) in the arrow direction, tabs (C) on the battery cover will come out and the battery cover can be removed.

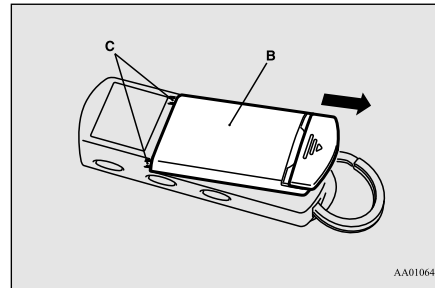

4. Remove the old batteries.
5. Install two new coin type CR2032 batteries (D) with the “+” side up.

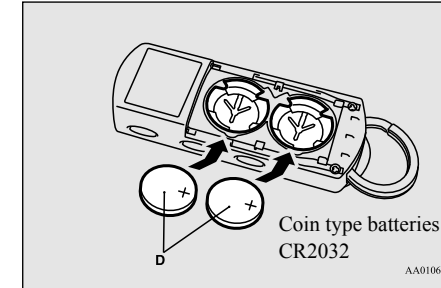

6. Attach the battery cover (A) in the reverse order from the way you have detached it.
7. Confirm the MiEV Remote can be turned ON. Refer to “To turn the MiEV Remote ON/OFF” on page 3-43.

NOTE

- Replace both batteries with new ones at the same time.
- A certified i-MiEV dealer can replace the batteries for you if you prefer.

3

MiEV Remote System

Actions to be taken when the MiEV Remote system does not operate correctly

N01204901032

3

Take the following actions when the system does not operate correctly. If the system still does not operate correctly after the action(s) have been taken, a system component may not be working properly. Please consult with a certified i-MiEV dealer to check it.

Phenomena		Cause	Remedy
Charging does not start when regular charge connector is inserted.		“ON” timer has been set.	Cancel the “ON” timer.
		The regular charge connector is not locked completely.	Lock the regular charge connector securely.
		A household electrical outlet, which the EV charging cable is connected to, is shut down.(e.g. disconnected plug)	Turn on the household electrical outlet and make sure the plug is securely connected.
MiEV Remote does not operate normally.	MiEV Remote is not powered on.	Batteries in the MiEV Remote are defective or the batteries are discharged.	Replace the batteries in the MiEV Remote. Refer to “Replacement of batteries for the MiEV Remote” on page 3-51.
	No indicator lights come on when the remote is turned on.		
	Melody or buzzer does not sound.	Melody or buzzer has been disabled.	Enable the melody or buzzer. Refer to “To turn on/off melody and buzzer” on page 3-49.



MiEV Remote System

3

Phenomena		Cause	Remedy
The following symbol blinks when the power supply/communication switch on the MiEV Remote is pressed. ● ERROR symbol ●  symbol	Blinks after about 1 second.	<ul style="list-style-type: none"> ● Electrical noise source is present in the vicinity of the MiEV Remote. (e.g. personal computer) ● Electrical noise source is present between the vehicle and the MiEV Remote. 	Move away from the noise source.
	Blinks after about 10 seconds.	The MiEV Remote antenna is not extended.	Extend the MiEV Remote antenna to communicate.
		Out of effective communication range. (e.g. too far away from the vehicle, or radio signal is interfered)	Move to the location where the system reaches the effective communication range.
		The electric motor switch is at the position other than “LOCK” position.	Turn the electric motor switch to the “LOCK” position.
		<ul style="list-style-type: none"> ● Electrical noise source is present in the vicinity of the vehicle. ● Electrical noise source is present between the vehicle and the MiEV Remote. 	Move away from the noise source.
12V starter battery is discharged.	Charge or replace the 12V starter battery. Refer to “Jump-starting” on page 8-2, “12V starter battery” on page 11-6.		
The below symbol blinks about 10 seconds after the power/communication switch on the MiEV Remote is pressed. ● ERROR symbol	Some errors occur while the system is in processing.	Press the power/communication switch again.	

MiEV Remote System

3

Phenomena	Cause	Remedy	
Charging Timer is not possible.	After the power/communication switch is pressed, the following symbol blinks in several seconds.	Regular charge connector is not inserted or not locked completely.	Lock the regular charge connector securely.
	<ul style="list-style-type: none"> ● ERROR symbol ●  symbol 	A household electrical outlet, which the EV charging cable (regular charger) is connected to, is shut down.(e.g. disconnected plug)	Turn on the household electrical outlet which the EV charging cable (regular charger) is connected to.
		Ground fault at the household electrical outlet. Otherwise, the power supply at the household electrical outlet is cut off.	Check the ground fault and confirm the plug is connected.
		If the charging unit is equipped with the timer function, the power supply to the unit has been cut off.	Preset the Charging Timer while the charging unit with timer function is powered on.
	After the power/communication switch is pressed, the following symbol blinks in several seconds.	The selector lever is at a position other than P (PARK).	Place the selector lever to P (PARK) position.
		Quick charging is in progress. (The  symbol illuminates.)	Terminate the quick charging, or wait until the quick charging completes.
<ul style="list-style-type: none"> ● ERROR symbol 		The temperature of the Main Drive Lithium-ion Battery has exceeded about 140 °F (60 °C).	Allow the temperature of the Main Drive Lithium-ion Battery to reach normal operating temperature. Refer to “Cautions and action to deal with intense heat” on page 3-8.



MiEV Remote System

Phenomena		Cause	Remedy
Charging Timer is not possible.	The system is charged although the ON timer is being set.	Backup charging for the Main Drive Lithium-ion Battery Warming System has been operated.	This is not a malfunction. Charging will be terminated when the system has been charged enough for the Main Drive Lithium-ion Battery Warming System.
	Charging is preset, but the specified charging level is not satisfied. ● The charging level is not expected amount. ● Is not charged. ● Is not charged at the preset time.	The timer is cancelled or the preset time is changed by using another MiEV Remote.	Check whether another person has operated his or her MiEV Remote.
		The electric motor switch has been operated before the system is charged.	Check whether the electric motor switch has been operated before the system is charged.
		The temperature of the Main Drive Lithium-ion Battery has exceeded about 140 °F (60 °C).	Allow the temperature of the Main Drive Lithium-ion Battery to reach normal operating temperature. Refer to “Cautions and action to deal with intense heat” on page 3-8.
	Although the charging is preset, too much time is needed to charge the system fully.	Charging Timer is not preset correctly.	Preset the timed charging again.
		The Remote Climate Control has been activated.	Check whether the Remote Climate Control has been activated.
The Main Drive Lithium-ion Battery Warming System has been operated.		Move the vehicle to a warmer location.	
	Temperature of the Main Drive Lithium-ion Battery is low.	Refer to “Cautions and action to deal with intense cold” on page 3-10.	
Charging Timer is not possible.	It is not fully charged.	If the charging unit is equipped with the timer function, the power supply to the unit has been cut off.	Preset the Charging Timer while the charging unit with timer function is powered on.

3

MiEV Remote System

3

Phenomena		Cause	Remedy
The Remote Climate Control cannot be activated.	After the power/communication switch is pressed, the following symbol blinks in several seconds. <ul style="list-style-type: none"> ● ERROR symbol ●  symbol 	The regular charge connector is not inserted or it is not locked completely.	Lock the regular charge connector securely.
		A household electrical outlet, which the EV charging cable (regular charge) is connected to, is shut down.(e.g. disconnected plug)	Turn on the household electrical outlet which the EV charging cable (regular charge) is connected to.
		Ground fault at the household electrical outlet. Otherwise, the power supply at the household electrical outlet is cut off.	Check the ground fault and confirm the plug is connected.
		If the charging unit is equipped with the timer function, the power supply to the unit has been cut off.	Preset the Charging Timer while the charging unit with timer function is powered on.
	After the power/communication switch is pressed, the following symbol blinks in several seconds. <ul style="list-style-type: none"> ● ERROR symbol ●  symbol 	The Main Drive Lithium-ion Battery charging level is low.	Charge the Main Drive Lithium-ion Battery until the MiEV Remote illuminates the battery charging level by at least 1 segment.

MiEV Remote System

Phenomena		Cause	Remedy
The Remote Climate Control cannot be activated.	After the power/communication switch is pressed, the following symbol blinks in several seconds. ● ERROR symbol	Any of the door or liftgate is open.	Close all the doors and liftgate.
		The selector lever is at the position other than P (PARK).	Place the selector lever to P (PARK) position.
		Quick charging is in progress. (The  symbol will illuminate.)	Terminate the quick charging, or wait until the quick charging completes.
		The temperature of the Main Drive Lithium-ion Battery has exceeded about 140 °F (60 °C).	Allow the temperature of the Main Drive Lithium-ion Battery to reach normal operating temperature. Refer to “Cautions and action to deal with intense heat” on page 3-8.
	The Remote Climate Control is not activated.	The electric motor switch has been operated before the system is charged.	Check whether the electric motor switch has been operated before the system is charged.
		The temperature of the Main Drive Lithium-ion Battery has exceeded about 140 °F (60 °C).	Allow the temperature of the Main Drive Lithium-ion Battery to reach normal operating temperature. Refer to “Cautions and action to deal with intense heat” on page 3-8.
The Remote Climate Control cannot be activated.	The heated seat is not powered on.	The heated seat switch is turned off.	Turn on the heated seat switch.
	The heated seat becomes hot while the air conditioning (cooling) is activated.	The heated seat switch is turned on.	Turn off the heated seat switch.

3

Cleaning the MiEV Remote

N01203600019

1. Gently wipe with gauze or another soft cloth soaked with a mild soap and water solution.
2. Wipe off all the detergent with a soft cloth dipped in fresh water and thoroughly wrung out.
3. Wipe all moisture off and dry in a shaded, well-ventilated area.

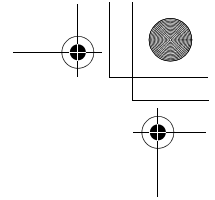
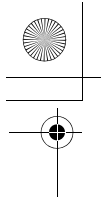

MiEV Remote System

CAUTION

- Never use benzine, petrol, or other organic solvents, or acid or alkaline solvents. Doing so could cause deformation, discolor, or malfunction. Also, these substances may be present in various cleaners, so check carefully before use.

3

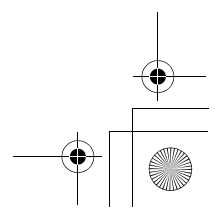
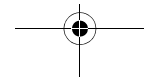
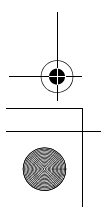
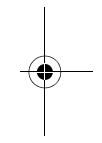
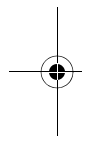

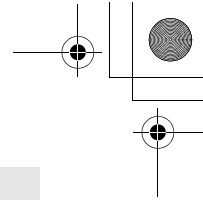
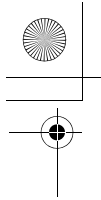

Seat and restraint systems

Seats	4-2
Seats and restraint systems	4-2
Front seats	4-3
Rear seats	4-5
Head restraints	4-6
Seat belts	4-8
Seat belt use during pregnancy	4-12
Seat belt pre-tensioner and force limiter systems	4-12
Child restraint systems	4-13
Maintenance and inspection of seat belts	4-20
Supplemental Restraint System (SRS) - airbag	4-20

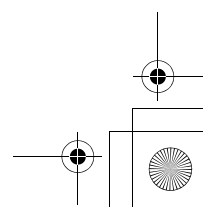
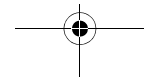
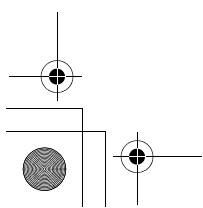
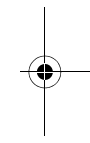
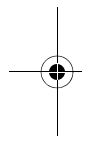

Seats

Seats

N00408400495

4

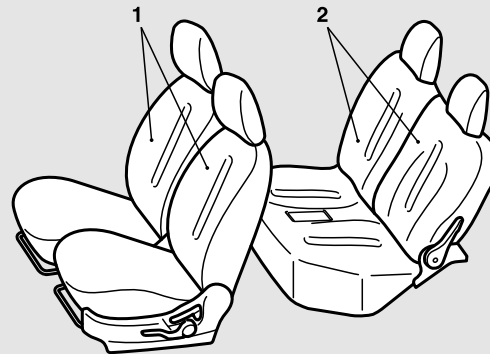

AA1008418

1 - Front seats

- To adjust the seat forward or backward → P.4-3
- To adjust the seatback → P.4-3
- To adjust the seat height (Driver's side only) → P.4-4
- Heated seats → P.4-4

2 - Rear seats

- To adjust the seatback → P.4-5
- Folding the seatbacks forward → P.4-6

Seats and restraint systems

N00401600209

Your vehicle has seat belts and other features that help protect you and your passengers in an accident.

Seat belts are the most important safety device. When worn properly, seat belts can reduce the chance of serious injury or death in various types of crashes. For added protection during a severe frontal collision, your vehicle has a Supplemental Restraint System (SRS) with airbags for the driver and passengers. The seats, head restraints, and door

locks are also safety equipment, which must be used correctly.

Always check the following before you drive:

- That everyone in your vehicle is properly wearing their seat belt.
- That infants and small children are properly secured in appropriate child restraint systems in the rear seat.
- That all doors are fully closed and locked.
- That seatbacks are upright, with head restraints properly adjusted.

Safety equipment cannot prevent injury or death in all motor vehicle accidents. You can help reduce the risk of injury or death, however, by following the instructions in this manual.

Front seats

N00401800386

Position the driver's seat as far back as possible while maintaining a position that still enables you to fully apply the pedals, easily control the steering wheel and safely operate the vehicle.

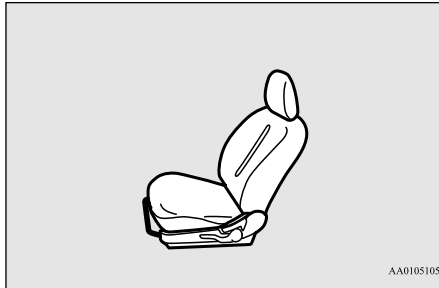

⚠ WARNING

- Do not attempt to adjust the seat while driving. This can cause loss of vehicle control and result in an accident.
- After adjusting the seat, make sure that the seat is securely locked into position.

⚠ WARNING

- To reduce the risk to the driver of serious injury or death during deployment of the driver's airbag, always properly wear the seat belt and adjust the driver's seat as far back as possible while maintaining a position that still enables you to fully apply the pedals, easily control the steering wheel, and safely operate the vehicle.
- To reduce the risk to the front passenger of serious injury or death during deployment of the passenger's airbag, always properly wear the seat belt and adjust the front passenger's seat as far back as possible.
- Always place children 12 years old and under in the rear seat and use appropriate child restraint systems.

⚠ CAUTION

- Make sure that the seat is adjusted by an adult. If it is adjusted by a child, an unexpected accident might occur.
- Do not place a cushion or the like between your back and the seatback while driving. The effectiveness of the head restraints will be reduced in the event of an accident.
- When sliding the seats, be careful not to catch your hand or leg.
- When sliding or reclining the seat rearward, pay careful attention to the rear seat passengers.

Front seats

To adjust the seat forward or backward

N00401900303

Pull the seat adjusting lever up and slide the seat forward or backward to the desired position. Release the adjusting lever to lock the seat in place.

4

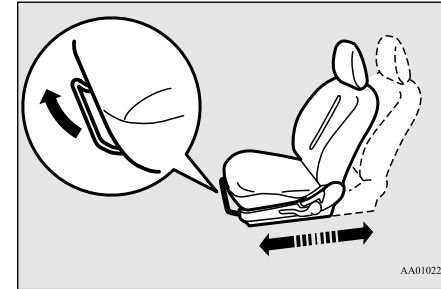

⚠ WARNING

- To make sure that the seat is securely locked, try to move it forward or backward without using the adjusting lever.

To adjust the seatback

N00402000356

To adjust the seatback, lean forward slightly, gently pull the seatback lock lever up, then lean backward to a comfortable position and

Front seats

release the lever. The seatback will lock in place.

4

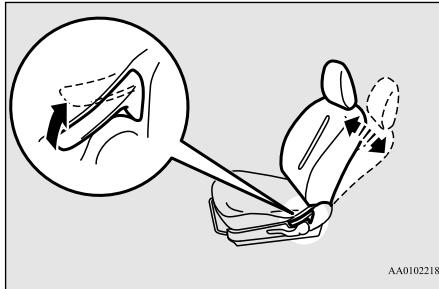

CAUTION

- The reclining mechanism used in the seatback is spring loaded, and will cause the seatback to return quickly to the vertical position when the lock lever is operated. When pulling the lever, sit close to the seatback or hold the seatback with your hand to control its return motion.

WARNING

- To reduce the risk of serious injury or death in the event of an accident or sudden stop, all seatbacks should be kept in the upright position while the vehicle is in motion. Seat belt performance during an accident can be adversely affected if the seatbacks are reclined. The more a seatback is reclined, the more likely seat belt performance will be adversely affected. If the seat belt is not properly positioned against the body during an accident, there is increased risk you will slide under the belt and receive serious injury or death.

To adjust the seat height (Driver's side only)

N00402100230

Operate the lever repeatedly to raise or lower the seat.

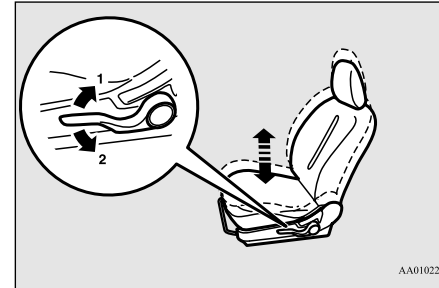

- 1- Raise
- 2- Lower

Heated seats

N00435601434

The heated seats can be operated when the electric motor switch is in the "ON" position.

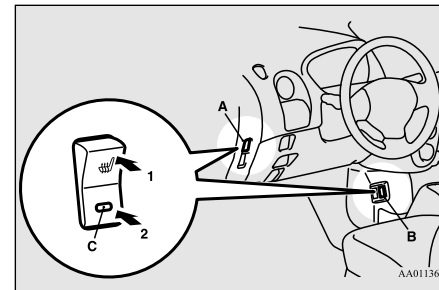

- A- For the driver's seat
- B- For the front passenger's seat

Rear seats

- 1- Heater on.
- 2- Heater off

The indicator light (C) will illuminate while the heater is on.

WARNING

● Persons who are unable to feel temperature change or skin pain due to age, illness, injury, medication, alcohol use, fatigue or other physical conditions or who have sensitive skin may suffer burns when using the heated seat even at low temperatures. To reduce the risk of burns, people with such conditions must use care when using the heated seat.

CAUTION

- Switch off the seat heater when not in use.
- Do not place heavy objects on the seat or stick pins, needles, or other pointed objects into the seat.
- Do not place a blanket, cushion, or other insulating material on the seat while using the heater; doing so can cause the heater element to overheat.
- When cleaning the seat, do not use benzine, kerosene, gasoline, alcohol, or other organic solvents; doing so can cause damage not only to the surface of the seat, but also to the heater.

CAUTION

- If water or any other liquid is spilled on the seat, allow it to dry thoroughly before attempting to use the heater.
- Turn the heater off immediately if it appears to be malfunctioning during use.

NOTE

- Do not turn the electric motor switch to the “ON” position; doing so will stop quick charging.
- You can use the heated seats while the Remote Climate Control is activated. Refer to “Remote Climate Control” on page 3-36, 3-47 and “For persons with electro-medical apparatus such as implantable cardiac pacemaker or implantable cardiovascular defibrillator” on page 3-6.

Rear seats

N00402500218

CAUTION

- Child restraint lower anchorages (A) are provided between the seat cushion and the seatback. Be careful that the lower anchorages may be hot due to heat of the electric motor unit room.

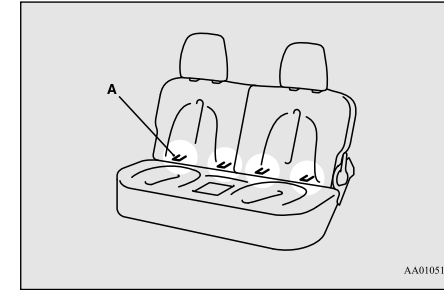

4

To adjust the seatback

N00402800022

To adjust the seatback, lean forward slightly, gently pull the seatback lock lever, then lean backward to a comfortable position and release the lever. The seatback will lock in place.

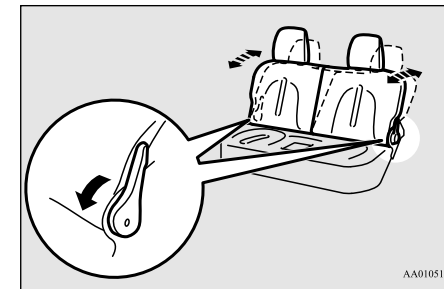

Head restraints

NOTE

- It is possible to adjust the seatback angle independently on each side.

4 Folding the seatbacks forward

N00402901219

The rear seatbacks can be folded forward to provide additional luggage compartment space.

Pull the lever, and fold the rear seatbacks forward. Confirm that the seatback locks securely when it is returned.

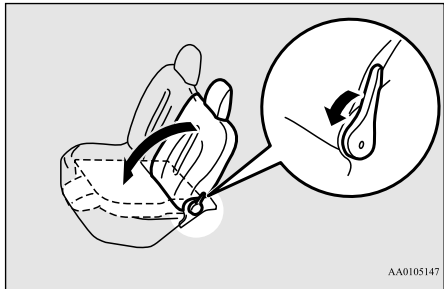

WARNING

- Do not allow anyone to ride in the center of rear seat or in the luggage compartment vehicle is in motion. People who are not properly seated and restrained can be seriously injured or killed in an accident.

WARNING

- To avoid reducing rearward vision, do not load cargo or luggage higher than the top of the seatback.
- Firmly secure cargo and luggage. Unsecured cargo and luggage can move during braking or in an accident, causing serious injury or death.

NOTE

- Do not push the lever toward the rear of the vehicle. Doing so could damage the lever and make it impossible to operate the seatback.



Head restraints

N00404300571

Padded head restraints for the seats can reduce the risk of a whiplash injury if your vehicle is hit from the rear.

The head restraints are equipped in the illustrated position.

To maximize the effectiveness of your head restraint, seatback to the upright position, and the head restraint to the proper position. Sit back against the seatback with your head close to the head restraint.

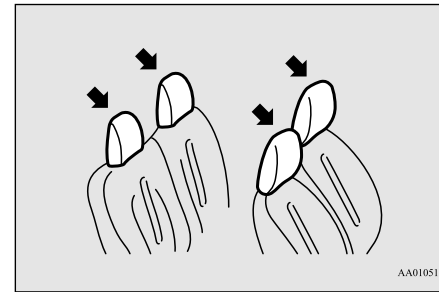

WARNING

- In order to minimize the risk of a neck injury due to a rear impact, the head restraint must be adjusted to the proper position before vehicle operation. For the driver and front passenger, the seatbacks must be adjusted to the upright position before adjusting the head restraints. The driver should never adjust the seat while the vehicle is in motion.

WARNING

- Driving without the head restraints in place can cause you and your passengers serious injury or death in an accident. To reduce the risk of injury in an accident, always make sure the head restraints are installed and properly positioned when the seat is occupied.
- Never place a cushion or similar device on the seatback. This can adversely affect head restraint performance by increasing the distance between your head and the restraint.

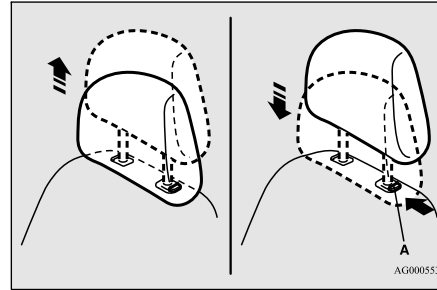

To remove

Press the lock knob (A) in the direction shown by the arrows. Then pull the head restraint up and out of the seatback.

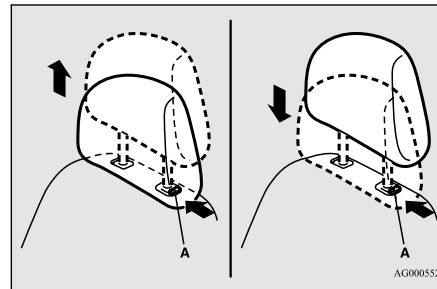

WARNING

- To help minimize the risk of neck injury in the event of an accident, the head restraints must be properly installed and positioned to proper height before vehicle operation.

To install

First check that the head restraint is facing in the right direction as shown in the previous illustration, and then insert it into the seatback. Push the head restraint down while pressing the lock knob (A) until the restraint locks into place.

CAUTION

- Check that the lock knob (A) is extended out as shown in the illustration. Then pull the head restraint up to make sure that it is locked in place and will not come out of the seatback.

Adjustment of the head restraint height

To reduce the risk of injury in an accident, adjust the head restraint height so that the center of the restraint is at your eye level when seated. Any person too tall for the restraint to reach their eye level when seated should raise the restraint to the highest locked position.

- To raise the restraint, pull it straight up.
- To lower the restraint, push down on it while pressing the lock knob (A) in the direction shown by the arrow.
- After adjusting the height, push down on the restraint to make sure it is locked in position.

Seat belts

4

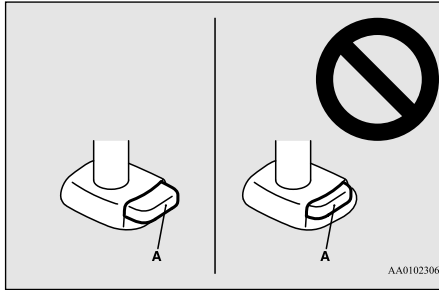

CAUTION

- The shape and size of the head restraint differs according to the seat. Always use the correct head restraint provided for the seat and do not install the head restraint in the wrong direction.

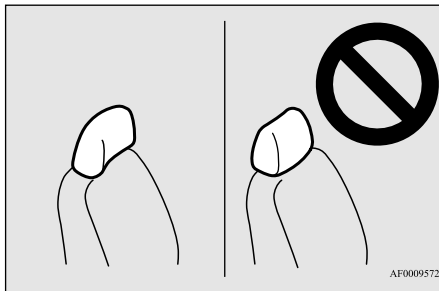

Seat belts

N00406001494

Seat belts are installed in your vehicle to help reduce the risk of injury to the driver and passenger in the event of an accident. Always use the provided seat belts. Carefully review the following information for proper seat belt usage.

WARNING

- To help reduce the risk of injury or death in an accident, seat belts and child restraint systems must always be used. Refer to “Child restraint systems” on page 4-13 for additional information.
- Never use one seat belt for more than one person.
- Never carry more people in your vehicle than there are seat belts.
- Always adjust the seat belt for a snug fit.
- Always place the shoulder belt over your shoulder and across your chest. Never put it behind you or under your arm.
- Always wear the lap belt as low as possible across your hips, not around your waist.
- Never modify or alter the seat belts in your vehicle.

WARNING

- To reduce the risk to the driver of serious injury or death during deployment of the driver’s airbag, always properly wear the seat belt and adjust the driver’s seat as far back as possible while maintaining a position that still enables you to fully apply the pedals, easily control the steering wheel, and safely operate the vehicle.
- To reduce the risk to a front seat passenger of serious injury or death from a deploying airbag, make sure the passenger always wears the seat belt properly, remains seated all the way back and upright in their seat, and moves the seat as far back as possible. Refer to “Supplemental Restraint System (SRS) - airbag” on page 4-20 for additional information.
- Never hold an infant or child in your arms or on your lap when riding in this vehicle even when you are wearing your seat belt. Never place any part of the seat belt you are wearing around an infant or child. Failure to follow these simple instructions creates a risk of serious injury or death to your child in the event of an accident or sudden stop.

⚠ WARNING

- Children 12 years old and under should always ride in the rear seat and be properly restrained. This reduces their risk of serious injury or death in an accident, especially due to a deploying front passenger's airbag. Refer to "Child restraint systems" on page 4-13 for additional information.
- Any child who is too small to properly wear a seat belt must be properly restrained in an appropriate child restraint system.
- Infants **MUST** be placed in a rear-facing child safety seat and positioned in the rear seat.
- In the event of an accident, all seat belt assemblies, including retractors and attachment hardware, should be inspected by a certified i-MiEV dealer to determine whether replacement is necessary.

retractor in the event of a sudden change in the vehicle's motion.

📖 NOTE

- For instructions on installing a child restraint system using a seat belt, refer to "Installing a child restraint system using the seat belt" on page 4-18.



4

1. Occupants should always sit back in their seats with their backs against the upright seatback. To reduce the risk of serious injury or death during deployment of the airbag, adjust the driver's seat as far back as possible while maintaining a position that still enables you to fully apply the pedals, easily control the steering wheel, and safely operate the vehicle. The front passenger seat should also be moved as far back as possible. Refer to "Supplemental Restraint System (SRS) - airbag" on page 4-20. Also refer to "To adjust the seat forward or backward" on page 4-3.

⚠ WARNING

- To reduce the risk of serious injury or death in the event of an accident or sudden stop, all seatbacks should be kept in the upright position while the vehicle is in motion. Seat belt performance during an accident can be adversely affected if the seatbacks are reclined. The more a seatback is reclined, the more likely seat belt performance will be adversely affected. If the seat belt is not properly positioned against the body during an accident, there is increased risk you will slide under the belt and receive serious injury or death.

Seat belt instructions

N00406200457

All seats are equipped with a seat belt which uses one combined lap-and-shoulder belt with an emergency locking retractor.

This system is designed to provide both comfort and safety. It permits full extension and automatic retraction of the belts during normal vehicle operation. A sensing device inside the belt retractor is designed to lock the

2. Grasp the latch plate and slide it up the webbing so that it easily pulls across your body.

Seat belts

4

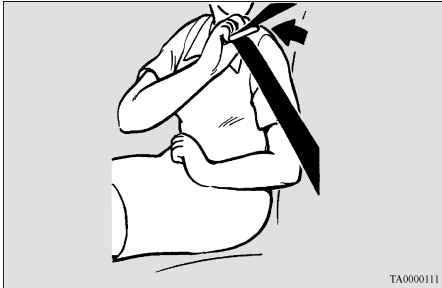

3. Pull the seat belt out slowly while holding the latch plate. Push the latch plate into the buckle until you hear a “click”. Pull up on the belt to be sure the latch plate is locked securely in the buckle.



NOTE

- If the seat belt locks up and cannot be pulled out, pull it once with force and let it retract all the way. Then, pull the belt out slowly once again.

4. The lap part of the belt must always be worn low and snug across the hips. Pull up on the shoulder portion of the belt to take up any slack in the lap belt.



NOTE

- With the exception of the seat belt for the driver, the seat belts in all other seating positions are equipped with an Automatic Locking Retractor (ALR) function. If you pull the seat belt fully out of the retractor, the retractor will switch to its ALR child restraint installation function (see page 4-18). When the ALR function has been activated, the seat belt will only retract. If this happens, let the belt fully retract, then pull the seat belt back out, repeating steps 1 through 4.

WARNING

- Be sure the lap belt portion fits snugly and is worn as low as possible across the hips, not around the waist. Failure to follow this instruction will increase the risk of serious injury or death in the event of an accident.
- Be sure the seat belt webbing is not twisted when worn. Twisted webbing may adversely affect seat belt performance.

5. To release the belt, press the button on the buckle and allow the belt to retract. If the belt does not retract smoothly, pull it out and check for kinks or twists in the webbing. Then make sure it remains untwisted as it retracts.

Driver's seat belt reminder/warning light

N00418400371

A tone and warning light are used to remind the driver to fasten the seat belt.

Seat belts

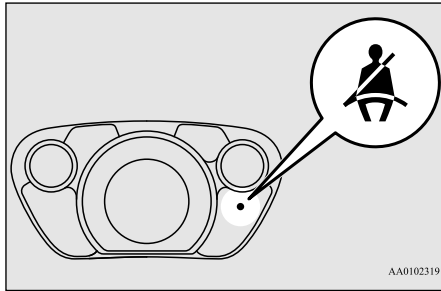

AA0102319

If the electric motor switch is turned to the “ON” position without the driver’s seat belt being fastened, a warning light will come on, and a tone will sound for approximately 6 seconds to remind you to fasten your seat belt.

If the seat belt remains unfastened approximately 1 minute later, the warning light will flash and the tone will sound intermittently for approximately 90 seconds when the vehicle is driven.

If the seat belt subsequently remains unfastened, the warning light and tone will issue further warnings each time the vehicle starts moving from a stop. And if the driver unfastens the seat belt while driving, the warning will operate in the same way. When the seat belt is fastened, the warnings will stop.

WARNING

- In order to reduce the risk of serious injury or death in an accident, always wear your own seat belt. Do not allow anyone to ride in your vehicle unless he or she is also seated and wearing a seat belt. Children should additionally be restrained in a secure child restraint system.

Front passenger seat belt warning light

N00418300224

The front passenger seat belt warning light is located in the instrument panel.

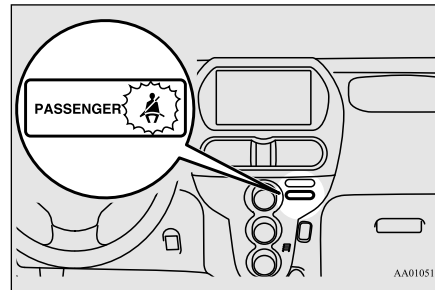

AA0105189

When the electric motor switch is turned to the “ON” position, this indicator normally comes on and goes off a few seconds later.

The light comes on when a person sits on the front passenger seat but does not fasten the seat belt.

It goes off when the seat belt is subsequently fastened.

WARNING

- When a child booster seat is used on the front passenger seat, the front passenger seat belt warning light will not come on, if the seat belt is not fastened when the booster seat is used. Confirm that the child is wearing the seat belt properly.
- Do not install any accessory or sticker that makes the light difficult to see.

4

Adjustable seat belt shoulder anchor (front seats)

N00406300328

The seat belt anchor height can be adjusted. To move the anchor, pull the lock knob (A) and slide the anchor to the desired position. Release the lock knob to lock the anchor into position.

Seat belt use during pregnancy

4

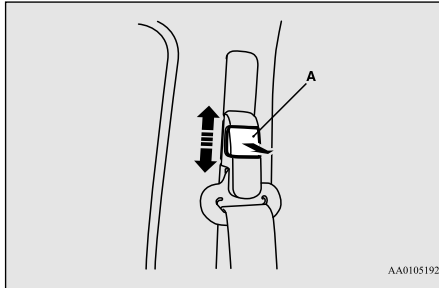

WARNING

- Always adjust the shoulder belt anchor so that the shoulder belt is positioned across the center of your shoulder without touching your neck. The shoulder belt should not be able to fall off your shoulder. Failure to follow this instruction can adversely affect seat belt performance and increase the risk of serious injury or death in the event of an accident.
- Adjust the shoulder belt anchor only when the vehicle is not in motion.
- Make sure the anchor is securely locked in position after adjusting it.

Seat belt extender

N0040670087

When your seat belt, even fully extended, is not long enough, a seat belt extender must be

obtained. The extender may be used for either of the front seats.

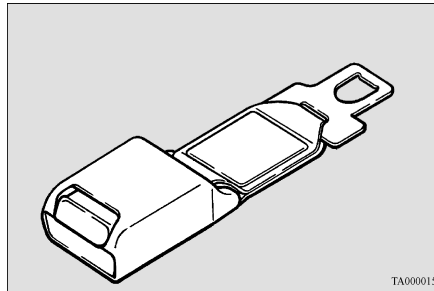

WARNING

- The extender should only be used if the existing belt is not long enough. Anyone who can use the standard seat belt should not use an extender. Unnecessary use of an extender can adversely affect seat belt performance in an accident.
- When not required, the extender must be removed and stowed.

Seat belt use during pregnancy

N00406800121

Seat belts work for everyone, including pregnant women. Like all occupants, pregnant women are more likely to be seriously injured

or killed in an accident if they do not wear seat belts.

WARNING

- To reduce the risk of serious injury or death to pregnant women and unborn children in an accident, pregnant women should always wear a seat belt. The lap portion of the seat belt should be worn snug and low across the hips and below the rounding. Consult your doctor if you have any additional questions or concerns.

Seat belt pre-tensioner and force limiter systems

N00417701736

The driver's and front passenger's seats each have a seat belt equipped with a pre-tensioner system and force limiter system.

Pre-tensioner system

The driver and front passenger seat belts are equipped with a seat belt pre-tensioner system. In moderate-to-severe front or side collisions, this system operates simultaneously with the deployment of the front airbags, side airbags or curtain airbags.

The seat belt pre-tensioners are located within the seat belt retractors (A). When activated,

the pre-tensioners quickly draw back seat belt webbing and increase seat belt performance.

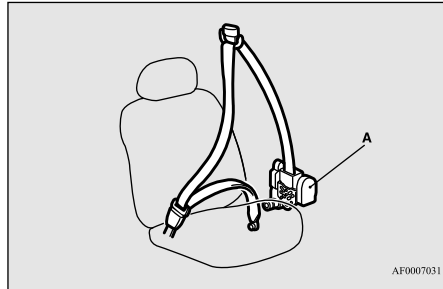

The seat belt pre-tensioner system includes the following components:

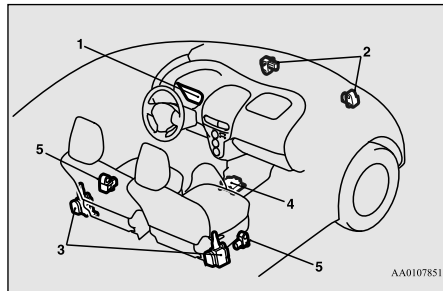

- 1- SRS warning light
- 2- Front impact sensors
- 3- Seat belt pre-tensioners
- 4- Airbag control unit
- 5- Side impact sensors

The airbag control unit monitors the readiness of the electronic parts of the system whenever the electric motor switch is in the “ON” or “START” position. These include all of the items listed above and all related wiring.

The pre-tensioner seat belt system will operate only when the electric motor switch is in the “ON” or “START” position.

When the seat belt pre-tensioners activate, some smoke is released and a loud noise will be heard. The smoke is not harmful, but care should be taken not to intentionally inhale it, as it may cause some temporary irritation to people with respiratory problems.

The pre-tensioners activate in the event of a moderate-to-severe front or side impact, even if the seat belt is not being worn. The seat belt pre-tensioners may not activate in certain frontal collisions, even though the vehicle may appear to be severely damaged. Such non-activation does not mean something is wrong with the seat belt pre-tensioner system, but rather that the collision forces were not severe enough or not of the type to activate the system.

Child restraint systems

WARNING

- The seat belt pre-tensioner system is designed to work only once. After the seat belt pre-tensioners have been activated, they will not work again. They must promptly be replaced and the entire seat belt pre-tensioner system inspected by a certified i-MiEV dealer.

4

SRS warning light

N00408700124

This warning light tells you if there is a problem involving the SRS airbags and/or the pre-tensioner seat belts. Refer to “SRS warning light” on page 4-26.

Force limiter system

N00408900113

In the event of an accident, the seat belt force limiter system will help reduce the force applied to the driver and front seat passenger.

Child restraint systems

N00407101795

When transporting infants or small children in your vehicle, an appropriate child restraint system must always be used. This is required by law in the U.S. and Canada.



Child restraint systems

4

Child restraint systems specifically designed for infants and small children are offered by several manufacturers. Choose only a child restraint system with a label certifying that it complies with Federal Motor Vehicle Safety Standard 213 (FMVSS 213) or Motor Vehicle Restraint Systems and Booster Seats Safety Regulations (RSSR). Look for the manufacturer's statement of compliance on the box and child restraint system itself.

The child restraint system should be appropriate for your child's weight and height, and should properly fit your vehicle's seat.

For detail information, refer to the instruction manual accompanying the child restraint system.

Guidelines for child restraint system selection

All children should be properly restrained in a restraint device that offers the maximum protection for their size and age.

Be sure to check local, state, or provincial requirements for child size and age that may vary from the recommendations listed below.

- Children less than 1 year old and who weigh 22 pounds (10 kg) or less **MUST** ride in a rear-facing child safety seat that **MUST ONLY** be used in the rear seat.

4-14 Seat and restraint systems



- Children older than 1 year of age and who weigh less than 40 pounds (18 kg) or who are less than 40 inches (100 cm) tall must be in a forward-facing restraint used only in the rear seat.
- Children who weigh more than 40 pounds (18 kg) or who are more than 40 inches (100 cm) tall, regardless of age, should use a suitable child seat or a booster seat in the rear seat until the vehicle's lap/shoulder belt fits them properly.

WARNING

- **All children must be seated in the rear seat, and properly restrained. Accident statistics show that children of all sizes and ages are safer when properly restrained in the rear seat, rather than in the front seat.**

WARNING

- **Any child who is too large to use a child restraint system should ride in the rear seat and wear the lap and shoulder belt properly. The shoulder belt must be positioned over the shoulder and across the chest, not across their neck, and with the lap belt positioned low on the child's hips, not across their stomach. If necessary, a booster seat should be used to help achieve a proper seat belt fit. Follow the booster seat manufacturer's instructions. Only use a booster seat that is certified as complying with Federal Motor Vehicle Safety Standards or Motor Vehicle Restraint Systems and Booster Seats Safety Regulations.**
- **Never hold an infant or child in your arms or on your lap when riding in this vehicle, even when you are wearing your seat belt. Never place any part of the seat belt you are wearing around an infant or child. Failure to follow these simple instructions creates a risk of serious injury or death to your child in the event of an accident or sudden stop.**

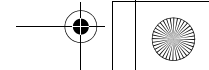
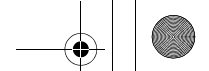

Child restraint systems

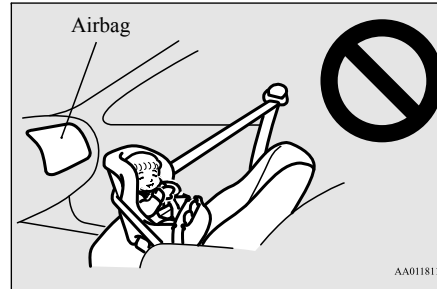

⚠ WARNING

- Your vehicle is also equipped with a front passenger's airbag. Never put REAR-FACING CHILD RESTRAINT SYSTEMS or INFANT RESTRAINT SYSTEMS in the front passenger seat. This places the infant too close to the passenger's airbag. During deployment of the airbag, the infant can be seriously injured or killed. Rear-facing child restraint systems or infant restraint systems must only be used in the rear seat.

⚠ WARNING

- FRONT-FACING CHILD RESTRAINT SYSTEMS should be used in the rear seat whenever possible. If they must be used in the front passenger seat, move the seat to the most rearward position and make sure the child stays in the child restraint system, properly restrained. Failure to follow these instructions could result in serious injury or death to the child.



⚠ WARNING

- It is important to use an approved rear-facing infant restraint until the infant is one year old (unless the infant outgrows the seat sooner). This allows the infant's neck and spine to develop enough to support the weight of their head in the event of an accident.
- When installing a child restraint system, follow the instructions provided by the manufacturer and follow the directions in this manual. Failure to do so can result in serious injury or death to your child in an accident or sudden stop.
- After installation, push and pull the child restraint system back and forth, and side to side, to see that it is firmly secured. If the child restraint system is not installed securely, it may cause injury to the child or other occupants in the event of an accident or sudden stop.
- When not in use, keep your child restraint system secured with the seat belt, or remove it from the vehicle, in order to prevent it from being thrown around inside the vehicle during an accident.

Child restraint systems

4

NOTE

- Before purchasing a child restraint system, try installing it in the rear seat to make sure there is a good fit. Because of the location of the seat belt buckles and the shape of the seat cushion, it may be difficult to securely install some manufacturer's child restraint systems. If the child restraint system can be pulled forward or to either side easily on the seat cushion after the seat belt has been tightened, choose another manufacturer's child restraint system.
- Depending on the seating position in the vehicle and the child restraint system that you have, the child restraint system can be attached using one of the following two methods:
 - To the lower anchorage in the rear seat ONLY if the child restraint system is compatible with the LATCH system (See page 4-16).
 - To the seat belt (See page 4-18).

Installing a child restraint system using the LATCH (Lower Anchors and Tethers for children) system

N00418800144

Lower anchor locations

The seating positions in the rear seat of your vehicle are equipped with lower anchors for attaching child restraint systems compatible with the LATCH system.

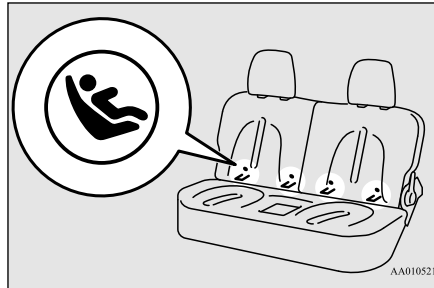

NOTE

- The symbols on the seatback show the location of the lower anchor points.

Tether anchor locations

N00418900187

Your vehicle has 2 attachment points on the floor of the luggage compartment. These are for securing a child restraint system tether strap to each of the 2 rear seating positions in your vehicle.

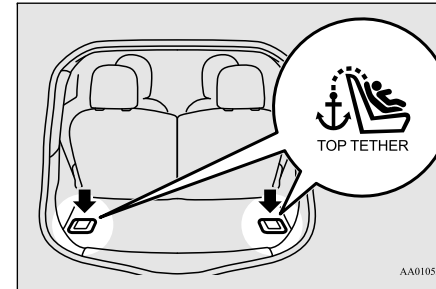

Examples of child restraint systems compatible with the LATCH system

N00419000185

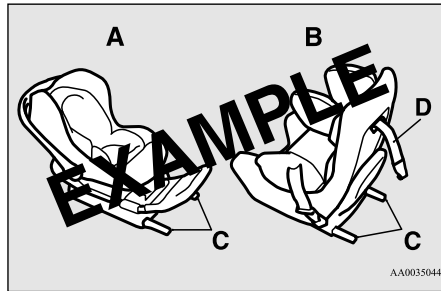

- A- Rear-facing child restraint system
- B- Front-facing child restraint system
- C- Child restraint system lower anchor connectors
- D- Tether strap (These are only examples.)

Using the LATCH system

N00419100229

1. In order to securely fasten the tether strap, remove the head restraint from the location where you wish to install the child restraint system.
2. Open the gap a little between the seat cushion (A) and the seatback (B) with your hand to locate the lower anchorages (C).

3. Push the anchor connectors (D) on the child restraint system into the lower anchors (C) in accordance with the instructions provided by the child restraint system manufacturer. Remember, the lower anchors provided with your vehicle are designed to secure suitable child restraint systems compatible with the LATCH system in the outboard positions of the rear seat only.

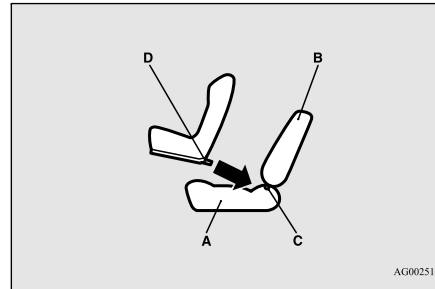

- A- Vehicle seat cushion
- B- Vehicle seatback
- C- Lower anchor
- D- Connector

NOTE

- In order to secure a child restraint system compatible with the LATCH system, use the lower anchor points in the rear seat. It is not necessary to use the vehicle's seat belt.

WARNING

- If there is any foreign material in or around the lower anchors, remove it before installing the child restraint system. Also, make sure the seat belt is away from, not looped through or otherwise interfering with, the child restraint system. If foreign matter is not removed and/or the seat belt interferes with the child restraint system, the child restraint system will not be secured properly, could detach and move forward in the event of sudden braking or an accident, and could result in injury to the child or other vehicle occupants.
- When the vehicle is moving, do not adjust the seat where the child restraint system is installed.

4

4. Open the cover (E) for the tether anchor by pulling it back with your hand as illustrated below (4).
5. Latch the tether strap hook (F) of the child restraint system to the anchor (G) as illustrated below (5) and tighten the top tether strap so it is securely fastened.

Child restraint systems

4

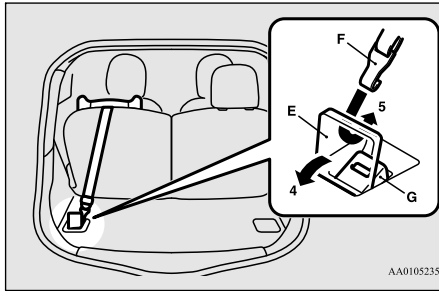

6. Push and pull the child restraint system in all directions to be sure it is firmly secured.

⚠ WARNING

- Child restraint system tether anchors are designed only to withstand loads from correctly fitted child restraint systems. Under no circumstances are they to be used for adult seat belts, harnesses, for attaching other items, or equipment to the vehicle.

Installing a child restraint system using the seat belt (with emergency/automatic locking mechanism)

N00407301481

With the exception of the driver, the seat belt in all other seating positions can be converted

4-18 Seat and restraint systems

from normal Emergency Locking Retractor (ELR) mode to Automatic Locking Retractor (ALR) mode. This means that when you pull the seat belt fully out of the retractor, the retractor will switch to its ALR child restraint installation function. Always use the ALR child restraint installation function when you install a child restraint system using the seat belt.

Children 12 years old and under should always be restrained in the rear seat, whenever possible, although the front passenger seat belt can also be converted to ALR mode.

⚠ WARNING

- When you install a child restraint system using the seat belt, always make sure the retractor has been switched to the ALR child restraint installation function. The ALR function will keep the child restraint system tightly secured to the seat. Failure to convert the retractor to the ALR function may allow the child restraint system to move forward during sudden braking or an accident, resulting in serious injury or death to the child or other occupants.

Installation

1. Place the child restraint system on the seat where you wish to install it.
To help assure proper fitting of the child restraint system, always remove the head restraint.
2. Route the seat belt through the child restraint system according to the instructions provided by the child restraint system manufacturer. Then insert the seat belt latch plate into the buckle. Make sure you hear a “click” when you insert the latch plate into the buckle.

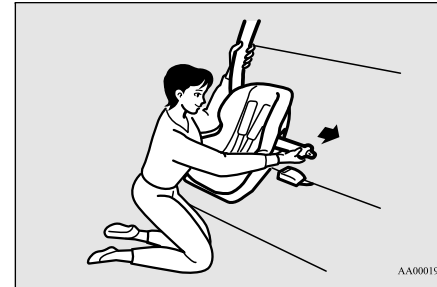

3. To activate the ALR child restraint installation function, slowly pull the shoulder part of the belt all the way out of the retractor until it stops. Then let the belt feed back into the retractor.

Child restraint systems

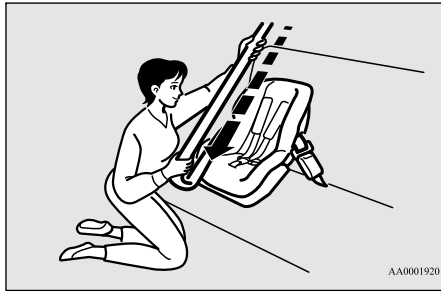

4. After the belt has retracted, tug on it. If the belt is in the ALR function, you will not be able to pull it out. If the webbing can be pulled out from retractor, the ALR function has not been activated and you will need to repeat steps 3 and 4.
5. After confirming that the belt is locked, grab the shoulder part of the belt near the buckle and pull up to remove any slack from the lap part of the belt allowing the slack to feed into the retractor. Remember, if the lap belt portion is not tight, the child restraint system will not be secure. It may help to put your weight on the child restraint system and/or push on its seat-back while pulling up on the belt (see illustration).

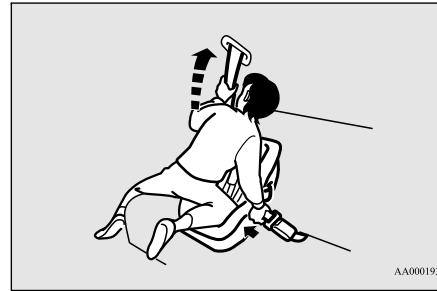

If your child restraint system requires the use of a tether strap, fasten the tether strap in accordance with the following procedures.

6. Open the cover from the tether anchor installation point by pulling it back with your hand as illustrated below (6).
7. Latch the tether strap hook (A) of the child restraint system to the tether anchor (B) as illustrated below (7) and tighten the top tether strap so it is securely fastened.

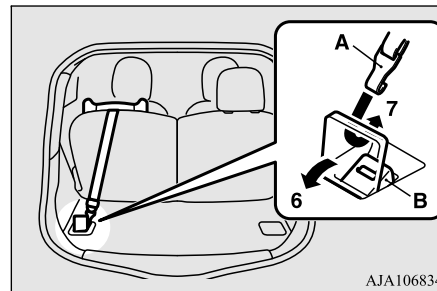

WARNING

- Child restraint system tether anchors are designed only to withstand loads from correctly fitted child restraint systems. Under no circumstances are they to be used for adult seat belts, harnesses, for attaching other items, or equipment to the vehicle.

4

8. Before putting your child in the restraint, push and pull the restraint in all directions to be sure it is firmly secured. Do this before each use. If the child restraint system is not firmly secure, repeat steps 1 through 7.
9. To remove a child restraint system from the vehicle and deactivate the ALR mode, remove the child from the restraint. Unlatch the buckle. Then remove the belt from the restraint and let the belt fully retract.
10. Reinstall the head restraint.
Refer to "Head restraints" on page 4-6.

Children who have outgrown child restraint systems

N00407601615

Children who have outgrown a child restraint system should be seated in the rear seat and wear the seat belt. If the shoulder belt crosses their face or neck, and/or the lap belt crosses their stomach, a commercially available

Maintenance and inspection of seat belts

booster seat must be used, to raise the child so that the shoulder belt crosses their shoulder and the lap belt remains positioned low across their hips. The booster seat should fit the vehicle seat and have a label certifying compliance with Federal Motor Vehicle Safety Standards or Motor Vehicle Restraint Systems and Booster Seats Safety Regulations.

4

WARNING

- Any child who is too small to properly wear a seat belt must be properly restrained in an appropriate child restraint system, to reduce their risk of serious injury or death in an accident.
- A child should never be left unattended in, or unsupervised, around your vehicle. When you leave the vehicle always take the child out as well.
- Children can die from heat stroke if left or trapped inside the vehicle, especially on hot days.
- Keep your vehicle locked when not in use. Keep your vehicle keys away from children.

Maintenance and inspection of seat belts

N00407000351

The seat belt webbing may be cleaned with mild soap or detergent solution. Do not use an organic solvent. Allow the belts to dry in the shade. Do not allow them to retract until completely dry. Do not attempt to bleach or re-dye the belts. The color may rub off and the webbing strength may be affected.

Regularly check your seat belt buckles and their release mechanisms for positive engagement and release of the latch plate. Check the retractors for automatic locking when in the Automatic Locking Retractor function.

The entire seat belt assembly should be replaced if the webbing shows any obvious cuts, tears, increase in thickness in any section of the webbing from broken fibers, or severe fading from sunlight. All of these conditions indicate a weakening of the belt, which may adversely affect seat belt performance in an accident.

WARNING

- Do not attempt to repair or replace any part of the seat belt assemblies. This work should be done by a certified i-MiEV dealer. Failure to have a certified i-MiEV dealer perform the work could reduce the effectiveness of the belts and could result in a serious injury or death in an accident.

Supplemental Restraint System (SRS) - airbag

N00407701834

This vehicle is equipped with a Supplemental Restraint System (SRS), which includes airbags for the driver and passengers.

The SRS front airbags are designed to supplement the primary protection of the driver and front passenger seat belt systems by providing those occupants with protection against head and chest injuries in certain moderate to severe frontal collisions.

The SRS front airbags, together with sensors at the front of the vehicle and sensors attached to the front seats, form an advanced airbag system.

The SRS side airbags and the curtain airbags are also designed to supplement the seat belts. The SRS side airbags provide the driver and front passenger with protection against chest,

Supplemental Restraint System (SRS) - airbag

abdomen and hip injuries by deploying the bag on the side impacted in moderate to severe side impact collisions. The SRS curtain airbags provide the driver and passengers on the front seat and rear seat with protection against head injuries by deploying a bag on the side impacted in moderate to severe side impact collisions.

The SRS airbags are NOT a substitute for use of the seat belts. For maximum protection in all types of accidents, seat belts must ALWAYS be worn by everyone who drives or rides in this vehicle (with infants and small children in an appropriate child restraint system in the rear seat, and older children buckled in the rear seat). Refer to “Child restraint systems” on page 4-13.

WARNING

- IT IS VERY IMPORTANT TO ALWAYS WEAR YOUR SEAT BELT PROPERLY EVEN WITH AN AIRBAG.

WARNING

- Seat belts help keep the driver and passengers properly positioned. This reduces the risk of injury in all collisions, and reduces the risk of serious injuries or death when the airbags inflate. During sudden braking just before a collision, an unrestrained or improperly restrained driver or passengers can move forward into direct contact with, or within close proximity to, the airbag when it begins to inflate.

The beginning stage of airbag inflation is the most forceful and can cause serious injuries or death if the occupant comes in contact with the airbag at this time.

- Seat belts reduce the risk of injury in rollovers, rear impact collisions, and in lower-speed frontal collisions, because the airbags are not designed to inflate in those situations.
- Seat belts reduce the risk of being thrown from your vehicle in a collision or rollover.
- IT IS VERY IMPORTANT TO BE PROPERLY SEATED.
 - A driver or front passenger sitting too close to the steering wheel or instrument panel during airbag deployment can be seriously injured or killed.

WARNING

- Airbags inflate very quickly and with great force. If the driver and front passenger are not properly seated and restrained, the airbag may not provide the proper protection and can cause serious injuries or death when it inflates.
- To reduce the risk to the driver of serious injury or death due to a deploying driver's airbag, always properly wear your seat belt and adjust the driver's seat as far back as possible, maintaining a position that still allows the driver to have good control of the steering wheel, brake, accelerator, and other vehicle controls.
- To reduce the risk to the front passenger of serious injury or death from a deploying passenger's airbag, make sure the passenger always wears the seat belt properly, remains seated upright and all the way back in the seat, and positions the seat as far back as possible.
- Seat all infants and children in the rear seat, properly restrained in an appropriate child restraint system.
- Airbags inflate very quickly and with great force. Do not sit on the edge of the seat or lean your head or chest close to the steering wheel or the instrument panel.
- Do not put your feet or legs on or against the instrument panel.

Supplemental Restraint System (SRS) - airbag

4

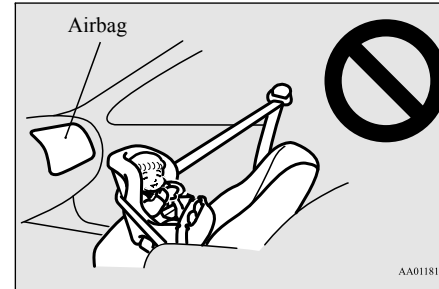
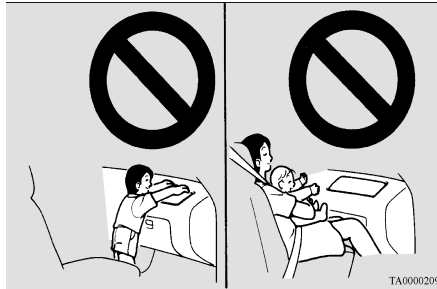
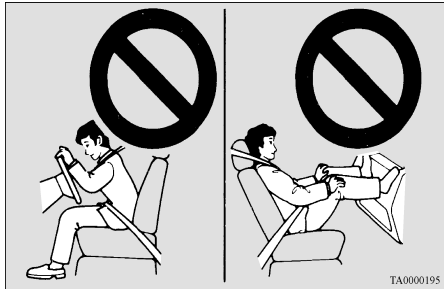

⚠ WARNING

- Infants and small children should never ride unrestrained, or lean against the instrument panel. They should never ride held in your arms or on your lap. They can be seriously injured or killed in an accident, especially when the airbags inflate. Infants and children should be properly seated in the rear seat in an appropriate child restraint system. Refer to “Child restraint systems” on page 4-13.

⚠ WARNING

- NEVER put REAR-FACING CHILD RESTRAINT SYSTEMS or INFANT RESTRAINT SYSTEMS in the front passenger seat. This places the infant too close to the passenger's airbag. During deployment of the airbag, the infant can be seriously injured or killed. Rear-facing child restraint systems or infant restraint systems must only be used in the rear seat.

⚠ WARNING

- FRONT-FACING CHILD RESTRAINT SYSTEMS should be used in the rear seat whenever possible. If they must be used in the front passenger seat, move the seat to the most rearward position and make sure the child stays in the child restraint system, properly restrained. Failure to follow these instructions could result in serious injury or death to the child.



Supplemental Restraint System (SRS) - airbag

WARNING

- Older children should be seated in the rear seat with their seat belt properly worn, and with an appropriate booster seat if needed. Refer to “Children who have outgrown child restraint systems” on page 4-19.

How the Supplemental Restraint System works

N00407800489

The SRS includes the following components:

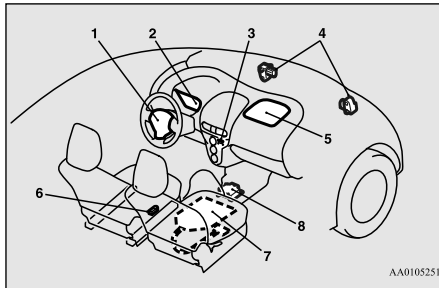

- 1- Driver's airbag
- 2- SRS warning light
- 3- Passenger's airbag off indicator
- 4- Front impact sensors
- 5- Passenger's front airbag
- 6- Driver's seat position sensor

- 7- Passenger's seat occupant classification sensor system
- 8- Airbag control unit

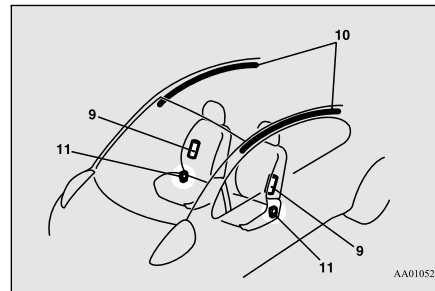

- 9- Side airbag modules
- 10- Curtain airbag modules
- 11- Side impact sensors

The airbag control unit monitors the readiness of the electronic parts of the system whenever the electric motor switch is in the “ON” or “START” position. These include all of the items listed above and all related wiring.

The airbags will operate only when the electric motor switch is in the “ON” or “START” position.

When the impact sensors detect a sufficient front or side impact to deploy the airbag(s), the appropriate airbag(s) will be deployed.

When airbags deploy, some smoke is released accompanied by a loud noise. The smoke is not harmful, but do not intentionally inhale the smoke as it may cause temporary irritation to people with respiratory problems.

After deployment, the airbags will quickly deflate, so quickly that some people may not even realize the airbags inflated.

Airbag inflation does not prevent the driver from seeing or being able to steer the vehicle, and does not prevent people from leaving the vehicle.

4

CAUTION

- Airbags inflate very quickly and with great force. In certain situations, contact with an inflating airbag may cause small cuts, abrasions, and bruises.

Event Data Recording

N00418600227

This vehicle is equipped with an event data recorder (EDR).

The main purpose of an EDR is to record, in certain crash or near crash-like situations, such as an airbag deployment or hitting a road obstacle, data that will assist in understanding how a vehicle's systems performed. The EDR is designed to record data related to vehicle dynamics and safety systems for a

Supplemental Restraint System (SRS) - airbag

short period of time, typically 30 seconds or less.

The EDR in this vehicle is designed to record such data as:

4

- How various systems in your vehicle were operating;
- Whether or not the driver safety belt was buckled/fastened;
- How far (if at all) the driver was depressing the accelerator and/or brake pedal; and,
- How fast the vehicle was traveling.

These data can help provide a better understanding of the circumstances in which crashes and injuries occur.

NOTE

- EDR data are recorded by your vehicle only if a non-trivial crash situation occurs; no data are recorded by the EDR under normal driving conditions and no personal data (e.g., name, gender, age, and crash location) are recorded. However, other parties, such as law enforcement, could combine the EDR data with the type of personally identifying data routinely acquired during a crash investigation.

To read data recorded by an EDR, special equipment is required, and access to the vehi-

4-24 Seat and restraint systems

cle or the EDR is needed. In addition to the vehicle manufacturer, other parties, such as law enforcement, that have the special equipment, can read the information if they have access to the vehicle or the EDR.

Driver's seat position sensor

N00417900210

The driver's seat position sensor is attached to the seat rail and provides the airbag control unit with information on the seat's fore-aft position. The airbag control unit controls deployment of the driver's front airbag in accordance with the information it receives from this sensor.

If there is a problem involving the driver's seat position sensor, the SRS warning light in the instrument panel will come on. Refer to "SRS warning light" on page 4-26.

WARNING

- If the SRS warning light comes on, have the vehicle inspected by a certified i-MiEV dealer as soon as possible.
- Please observe the following instructions to ensure that the driver's seat position sensor can operate correctly.
 - Adjust the seat to the correct position, and sit well back against the seatback. Refer to "Front seats" on page 4-3.
 - Do not recline the seatback more than necessary when driving.

WARNING

- Do not place metallic objects or luggage under the front seat.
- If the vehicle is involved in a severe impact, have the SRS sensor inspected by a certified i-MiEV dealer as soon as possible.

Passenger's seat occupant classification sensor system

N00418000351

The passenger's seat occupant classification sensor system is attached to the front passenger seat cushion and provides the airbag control unit with information regarding the occupant on the front passenger seat. The airbag control unit controls deployment of the passenger's front airbag in accordance with the information it receives from this system.

The passenger's front airbag will not deploy in an impact when the system senses no occupant on the front passenger's seat or a child in a child restraint system. In this case, the passenger's airbag off indicator will come on.

Refer to "Passenger's airbag off indicator" on page 4-25.

If there is a problem involving the passenger's seat occupant classification sensor system, the SRS warning light in the instrument panel will come on. Refer to "SRS warning light" page 4-26.

Supplemental Restraint System (SRS) - airbag

WARNING

- If any of the following conditions occur, you should immediately have your vehicle inspected by a certified i-MiEV dealer as soon as possible:
 - The SRS warning light does not initially come on when the electric motor switch is turned to the “ON” or “START” position.
 - The SRS warning light does not go out after several seconds.
 - The SRS warning light comes on while you are driving.
- To ensure that the passenger’s seat occupant classification sensor system can sense correctly, observe the following instructions. Failure to follow these instructions can adversely affect the performance of the passenger’s airbag system.
 - Adjust the seat to the correct position, and sit well back against the seatback. Refer to “Front seats” on page 4-3.
 - Do not recline the seatback more than necessary.
 - Never have more than one person (adult or child) sitting on the seat.
 - Do not place anything between the seat and the floor console.
 - When attaching a child restraint system, secure it firmly.
 - Do not place luggage or other objects on the seat.
 - Do not use a seat cover or a cushion.

WARNING

- Do not modify or replace the seat and seat belt.
- Do not place luggage or other objects under the seat.
- Do not place and use an electronic device such as a computer on the seat.
- Do not place heavy objects on the seat or stick pins, needles, or other objects into it.
- Do not remove the seat cushion skin.
- If any liquid is spilled on the seat, wipe it and dry the seat immediately.
- If the vehicle is involved in a severe impact, have the SRS sensors inspected by a certified i-MiEV dealer as soon as possible.

Passenger’s airbag off indicator

N00418100310

The passenger’s airbag off indicator is located in the instrument panel.

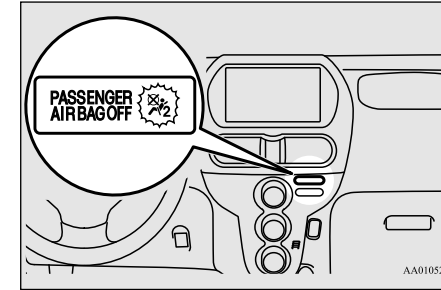
**4**

The indicator normally comes on when the electric motor switch is turned to the “ON” position and goes out a few seconds later. In the following situations, the indicator will stay on to show that the passenger’s front airbag is not operational.

- The front passenger’s seat is not occupied.
- The system senses that a child is in the child restraint system on the front passenger’s seat.

When the passenger’s seat occupant classification sensor system senses there is a person seated in the front passenger’s seat, the indicator goes out to show that the passenger’s front airbag is operational.

Supplemental Restraint System (SRS) - airbag

4

⚠ WARNING

- If any of the following conditions occur, you should immediately have the airbag system in your vehicle inspected by a certified i-MiEV dealer as soon as possible:
 - The passenger's airbag off indicator comes on when an adult is sitting on the front passenger seat.
 - The passenger's airbag off indicator does not come on when the front passenger's seat is not occupied.
 - The passenger's airbag off indicator does not come on when the electric motor switch is turned to the "ON" position.
 - The passenger's airbag off indicator comes on and goes out repeatedly.
- Do not attach any accessory to your vehicle that makes the passenger's airbag off indicator difficult or impossible to see. You must be able to see the passenger's airbag off indicator and verify the status of the passenger's airbag system.

SRS warning light

N00408301606

There is a Supplemental Restraint System (SRS) warning light on the instrument panel. The system checks itself every time the electric motor switch is turned on. The SRS warning light will come on for several seconds and then go out. This is normal and means the system is working properly. If there is a prob-

4-26 Seat and restraint systems

lem involving one or more of the SRS components, the warning light will come on and stay on. The SRS warning light is shared by the SRS airbag and the seat belt pre-tensioner system.

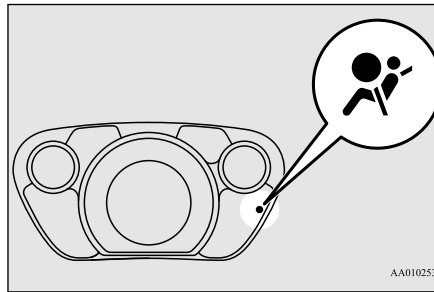

AA0102537

⚠ WARNING

- If any of the following conditions occur, there may be a problem with the SRS airbags and/or seat belt pre-tensioners, and they may not function properly in a collision or may suddenly activate without a collision:
 - Even when the electric motor switch is in "ON" position, the SRS warning light does not come on or it remains on.
 - The SRS warning light comes on while driving.

⚠ WARNING

The SRS airbags and seat belt pre-tensioners are designed to help reduce the risk of serious injury or death in certain collisions. If either of the above conditions occurs, immediately have your vehicle checked by a certified i-MiEV dealer.

Driver's and passenger's front airbag system

N00407900321

The driver's airbag is located under the padded cover in the middle of the steering wheel. The front passenger's airbag is contained in the instrument panel above the glove compartment. The driver's airbag and the front passenger's airbag are designed to deploy at the same time. However, the front passenger's airbag does not deploy when the front passenger seat is not occupied or when the system senses that a child is in the child restraint system.

Supplemental Restraint System (SRS) - airbag

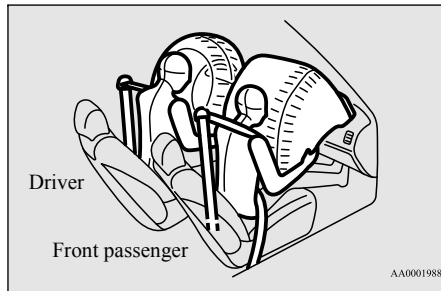

4

Deployment of front airbags

N0040800589

The front airbags ARE DESIGNED TO DEPLOY when...

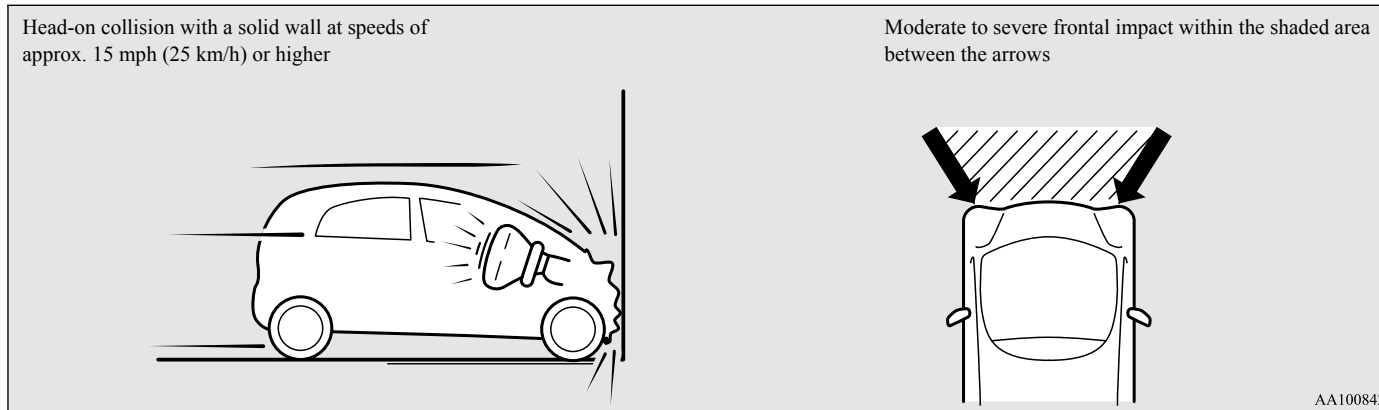

Supplemental Restraint System (SRS) - airbag

The front airbags are designed to deploy when the vehicle suffers a moderate to severe frontal impact. A typical condition is shown in the illustration to the left.

4

The front airbags are designed to deploy only in certain moderate to severe frontal collisions within the shaded area between the arrows in the illustration to the right.

The front airbags will deploy if the impact to the vehicle's main structure is above a specific threshold level. The threshold level is approximately 15 mph (25 km/h) for a frontal collision straight into a solid flat wall that does not bend or deform. If the impact to the vehicle's main structure is below this threshold level, the front airbags may not deploy. This threshold level may also be higher if the vehicle hits something that absorbs the impact, either by bending or moving (for example, another stationary vehicle, a pole or a guard rail).

The beginning stage of airbag inflation is the most forceful, and can cause serious injuries or death if you are too close to the deploying airbag. Accordingly, it is important that you always wear the available seat belt.

The front airbags MAY NOT DEPLOY when ...

In certain types of front collisions, the front airbags may not deploy, even if the deformation of the body seems to be large, because the vehicle's body structure is designed to absorb the impact and deform in order to help protect the occupants. Some typical situations where the front airbags may not deploy are shown in the illustrations.

Because the front airbags do not protect the occupant in all types of frontal collisions, be sure to always wear your seat belts properly.

Collision with a utility pole, tree or other narrow objects

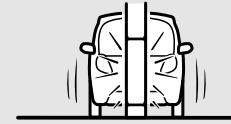

Collision where the vehicle slides under the rear body of a truck

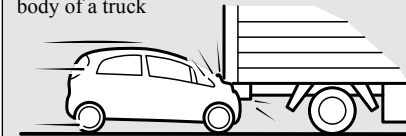

Oblique frontal impact

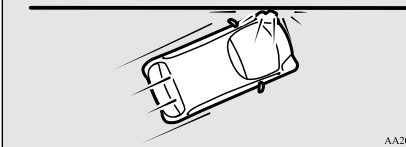

AA2002064

The front airbags ARE NOT DESIGNED TO DEPLOY when ...

The front airbags are not designed to deploy in situations where they cannot provide protection to the occupants.

Supplemental Restraint System (SRS) - airbag

Some typical situations are shown in the illustrations.

Because the front airbags do not protect the occupants in all types of collisions, be sure to always wear your seat belts properly.

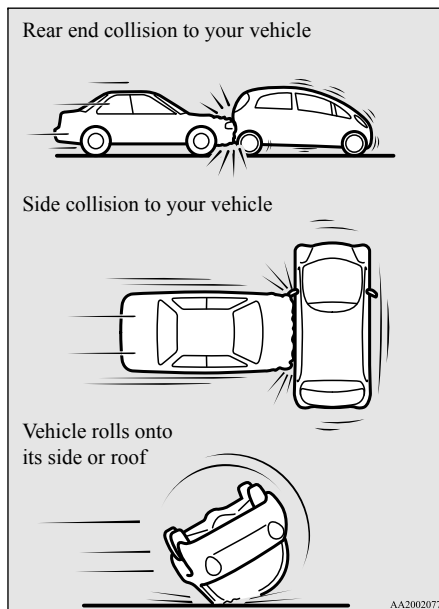

The front airbags MAY DEPLOY when ...

The front airbags may deploy if the underside of the vehicle suffers a moderate to severe impact (undercarriage impact). Some typical situations are shown in the illustrations.

Because the front airbags may deploy in certain types of unexpected impacts, as shown in the illustrations, and these unexpected impacts can move you out of position, it is important to always wear your seat belts properly. When worn properly, seat belts can help maintain your distance from the airbags when they begin to inflate. The beginning stage of airbag inflation is the most forceful and can cause serious injury or death if you are close to the deploying airbag.

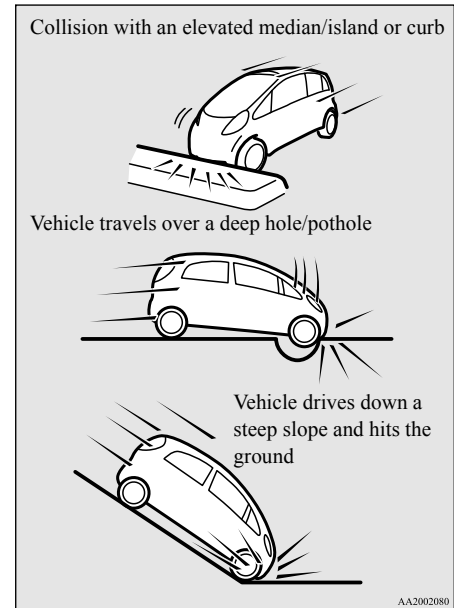

4

Supplemental Restraint System (SRS) - airbag

4

⚠ WARNING

- Do not attach anything to the steering wheel's padded cover, such as trim material, badges, etc. These could strike and injure an occupant if the airbag inflates.
- Do not set anything on, or attach anything to, the instrument panel above the glove compartment. Such items could strike and injure an occupant if the airbag inflates.

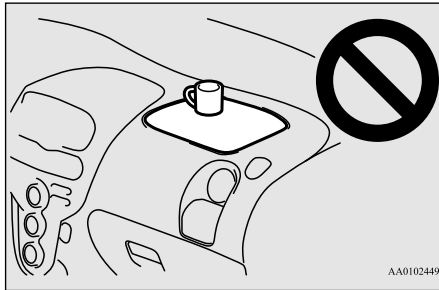

⚠ WARNING

- Do not attach accessories to, or put them in front of, the windshield. They could restrict the airbag inflation, or strike and injure an occupant, when the airbag inflates.
- Do not attempt to remove, install, disassemble or repair the SRS airbags.

⚠ WARNING

- Do not place objects, such as packages or pets, between the airbags and the driver or the front passenger. Such objects can adversely affect airbag performance, or cause serious injury or death when the airbag deploys.
- Immediately after airbag inflation, some parts of the airbag system will be hot. Do not touch them. You could be burned.
- The airbag system is designed to work only once. After the airbags deploy, they will not work again. They must promptly be replaced and the entire airbag system must be inspected by a certified i-MiEV dealer.

Side airbag system

N00408100418

The side airbags (A) are contained in the driver and front passenger seatbacks. The side airbag is designed to inflate only on the side of the vehicle that is impacted, even with no passenger in the front seat.

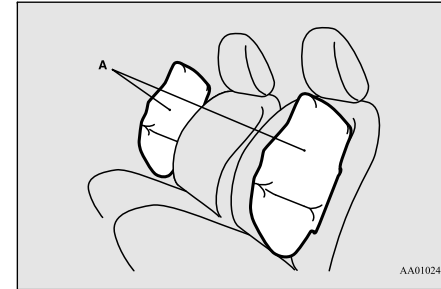

A label is attached to the seatbacks in vehicles with side airbags.

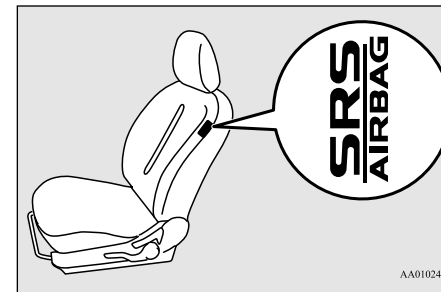

Supplemental Restraint System (SRS) - airbag

Curtain airbag system

N00419200204

The curtain airbags are contained in the front pillars and roof side rail. The curtain airbag is designed to inflate only on the side of the vehicle that is impacted, even with no passenger in the front seat.

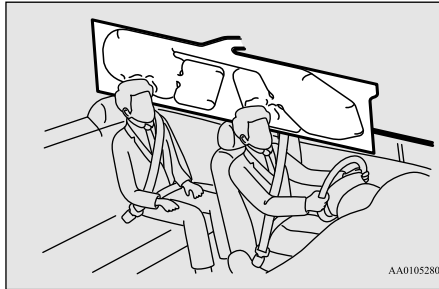

⚠ WARNING

- The side airbag and curtain airbag can cause serious injury or death to anyone too close to the airbag when it deploys. To reduce the risk of injury from a deploying side airbag and curtain airbags, all occupants must be properly restrained and seated well back, upright, and in the middle of the seat. Do not lean against the door.



⚠ WARNING

- In order to reduce the risk of injury from a deploying side airbag, do not allow any rear seat passengers to hold onto the back of either front seat. Special care should be taken with children.
- Do not place any objects near or around the front of either front seatback. Such objects can interfere with proper side airbag deployment and cause injury during deployment of the side airbag.
- Do not place stickers, labels or additional trim on the back of either front seat. They can interfere with proper side airbag deployment.
- Do not install seat covers or re-cover seats that have side airbags. Covers can interfere with proper side airbag deployment and adversely affect side airbag performance.

⚠ WARNING

- Do not attach a microphone (A) or any other object around the part where the curtain airbag (B) deploys, such as on the windshield, side door glass or front and rear pillars and roof side rail. When the curtain airbag inflates, the microphone or other object may be hurled with great force or the curtain airbag may not inflate correctly, resulting in death or serious injury.

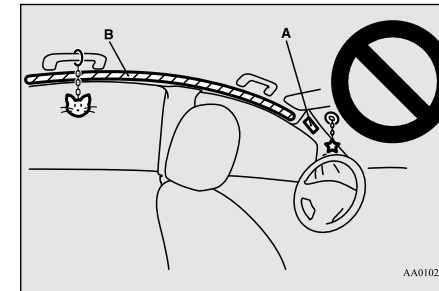

⚠ WARNING

- Never install a rear-facing child restraint system in the front passenger seat. Rear-facing child restraint systems **MUST ONLY** be used in the rear seat.

4

Supplemental Restraint System (SRS) - airbag

4

WARNING

- Front-facing child restraint systems should also be used **ONLY** in the rear seat. If a front-facing child restraint system must be used in the front passenger seat, move the seat as far back as possible, and make sure that the child stays in the child restraint system, properly restrained and away from the door.
- Do not allow a child to lean against or sit close to the passenger door, even if the child is seated in a child restraint system. The child's head should also not lean against or be close to the section of the seatback where the side airbag and curtain airbag are located. It is dangerous if the side airbag and curtain airbag deploys. Failure to follow all of these instructions could lead to serious injury or death to the child.
- Work done on or in the vicinity of the side airbag and curtain airbag system components should be done only by a certified i-MiEV dealer. Improper work methods can cause accidental side airbag and curtain airbag deployment, or render a side airbag and curtain airbag inoperable. Either of these situations can result in serious injury or death.

Deployment of side airbag and curtain airbag

N00408200523

The side airbag and curtain airbag ARE DESIGNED TO DEPLOY when ...

A side airbag and curtain airbag are designed to deploy when the vehicle suffers a moderate to severe side impact to the middle of the passenger compartment.

The typical situation is shown in the illustration.

Moderate to severe impact to the middle of the vehicle body's side structure

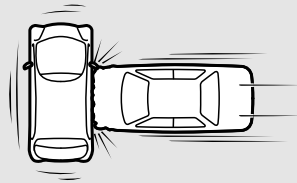

AA0102481

The seat belts in your vehicle are your primary means of protection in an accident. The SRS side airbags and curtain airbags are designed to provide additional protection. Therefore, for your safety and the safety of all

occupants, be sure to always wear your seat belts properly.

The side airbag and curtain airbag MAY NOT DEPLOY when ...

In certain types of side collisions, the side airbag and curtain airbag may not deploy, even if the deformation of the body seems to be large, because the vehicle's body structure is designed to absorb the impact and to deform in order to help protect the occupants. Some typical situations where the side airbag and curtain airbag may not deploy are shown in the illustrations.

Because the side airbags and curtain airbags do not protect the occupant in all types of side collisions, be sure to always wear your seat belts properly.

Supplemental Restraint System (SRS) - airbag

4

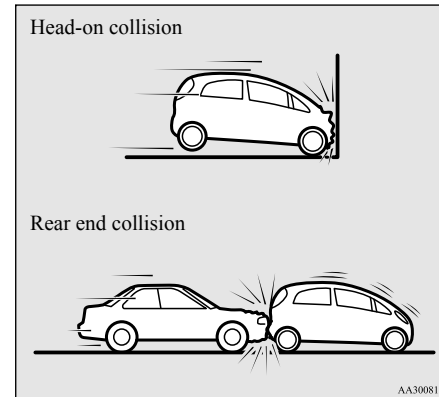
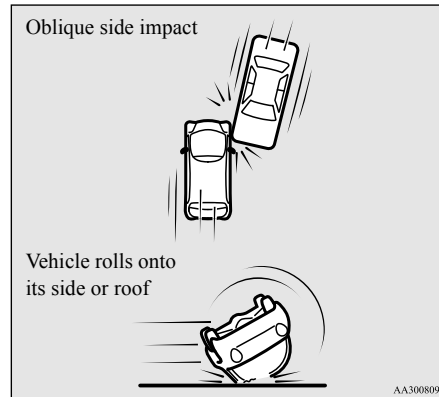
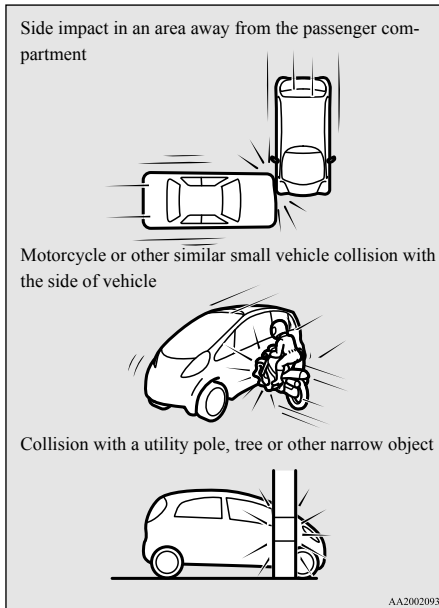

The side airbag and curtain airbag ARE NOT DESIGNED TO DEPLOY when ...

The side airbag and curtain airbag are not designed to deploy in situations where they cannot provide protection to the occupants. Some typical situations are shown in the illustrations.

Because the side airbags and curtain airbags do not protect the occupants in all types of collisions, be sure to always wear your seat belts properly.

Supplemental Restraint System (SRS) - airbag

SRS servicing

N00408500715

4

WARNING

- Any maintenance performed on or near the components of the SRS should be performed only by a certified i-MiEV dealer. Do not permit anyone else to do any service, inspection, maintenance or repair on any SRS components or wiring. Similarly, no part of the SRS should ever be handled, removed or disposed by anyone except a certified i-MiEV dealer. Improper work methods on the SRS components or wiring could result in an accidental airbag deployment or could make the SRS inoperable. Either of these situations could result in serious injury or death.
- Do not modify your steering wheel or any other SRS component or related vehicle part. For example, replacement of the steering wheel, or modifications to the front bumper or body structure can adversely affect SRS performance and may lead to injury.
- If your vehicle has received any damage, you should have the SRS inspected by a certified i-MiEV dealer to make sure it is in proper working order.

WARNING

- Do not modify your front seats, center pillar or center console. Such modifications can adversely affect SRS performance and may lead to injury. Also, if you discover any tear or open seam in the seat fabric near the side airbag, have the seat inspected by a certified i-MiEV dealer.
- If you find a crack in or damage to the front pillar, rear pillar, or roof side rail where the curtain airbag is located, have the SRS inspected by a certified i-MiEV dealer.

NOTE

- When you transfer ownership of the vehicle to another person, we urge you to alert the new owner that it is equipped with the SRS and refer that owner to the applicable sections in this owner's manual.
- If you decide to junk or scrap your vehicle, we urge you to first take it to a certified i-MiEV dealer so that the SRS can be made safe for disposal.
- If any of the following parts needs to be modified for use by a handicapped person, the advanced airbag system will be greatly affected. Please consult a certified i-MiEV dealer for assistance.
 - Driver's seat
 - Front passenger seat
 - Front seat belt

NOTE

- Steering wheel
- Instrument panel

[For vehicles sold in U.S.A.]

To contact Mitsubishi Motors North America, Inc.
call 1-888-648-7820 or write to:
Mitsubishi Motors North America, Inc.
Customer Relations Department
P. O. Box 6400
Cypress, CA 90630-0064

[For vehicles sold in Canada]

To contact Mitsubishi Motor Sales of Canada, Inc.
call 1-888-576-4878 or write to:
Mitsubishi Motor Sales of Canada, Inc.
Customer Relations Department
P.O. Box 41009
4141 Dixie Road
Mississauga, ON L4W 5C9

Warning labels

N00408600370

Occupant restraint warning labels for the SRS are located in the vehicle as shown in the illustration.

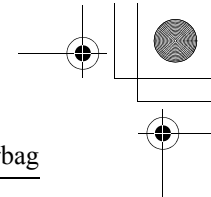
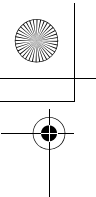

Supplemental Restraint System (SRS) - airbag

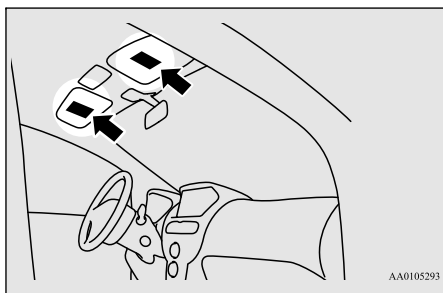

4

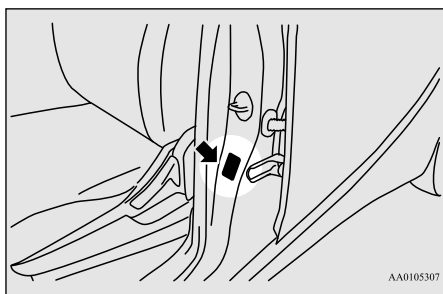

Located in the passenger's side as well.

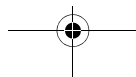
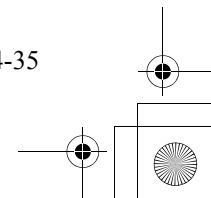
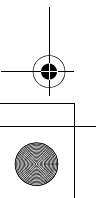

Features and controls

Break-in recommendations	5-2	Warning lights	5-44
Keys	5-2	Combination headlights and dimmer switch	5-46
Electronic immobilizer (Anti-theft starting system)	5-2	Turn signal lever	5-49
Keyless entry system	5-5	Hazard warning flasher switch	5-49
Door locks	5-8	Front fog light switch	5-50
Power door locks	5-9	Wiper and washer switch	5-50
Child safety locks for rear door	5-10	Electric rear window defogger switch	5-52
Liftgate	5-11	Horn switch	5-53
Theft-alarm system	5-12	Link System (if so equipped)	5-53
Power window control	5-14	Bluetooth [®] 2.0 interface (if so equipped).....	5-53
Parking brake	5-16	USB input terminal (if so equipped)	5-73
Inside rearview mirror	5-16	Sun visors	5-76
Outside rearview mirrors	5-17	12 V power outlet	5-76
Electric motor switch	5-18	Interior lights	5-79
Steering wheel lock	5-20	Storage spaces	5-79
Starting the electric motor unit	5-20	Cup holder	5-80
Selector lever	5-21	Assist grip	5-81
Acoustic vehicle alerting system (AVAS)	5-23		
Service brake	5-24		
Brake assist system	5-25		
Anti-lock braking system	5-25		
Electric power steering system (EPS)	5-27		
Active stability control (ASC)	5-28		
Tire pressure monitoring system	5-30		
Rear-view camera (if so equipped).....	5-34		
Instrument cluster	5-36		
Indicator and warning light package	5-43		
Indicators	5-44		

Break-in recommendations

Break-in recommendations

N00508700343

Advanced automobile manufacturing techniques permit you to operate your new vehicle without requiring a long break-in period of low-speed driving.

5

However, you can add to the future performance and economy of your vehicle by observing the following precautions during the first 300 miles (500 km).

Drive your vehicle at moderate speeds during the break-in period.

- Do not overload the vehicle. Observe the seating capacity (See “Cargo load precautions” on page 6-10).
- Do not use this vehicle for trailer towing.

Keys

N00508800618

Two keys are provided.
The keys fit all locks. Keep one in a safe place as a spare key.

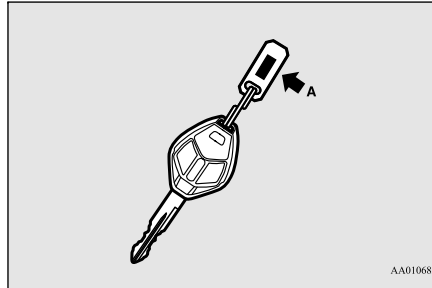

NOTE

- The key number (A) is stamped on the key number plate as shown in the illustration. Make a record of the key number and store the key and key number plate in separate places, so that you can order a key from a certified i-MiEV dealer if the original keys are lost.
- The key is a precision electronic device with a built-in signal transmitter. Please observe the following in order to prevent damage.
 - Do not leave where it may be exposed to heat caused by direct sunlight, such as on top of the dashboard.
 - Do not take the remote control transmitter apart.
 - Do not excessively bend the key or subject it to strong impacts.
 - Keep the remote control transmitter dry.
 - Keep away from magnetic objects such as key holders.

NOTE

- Keep away from devices that produce magnetism, such as audio systems, computers and televisions.
- Do not clean with ultrasonic cleaners.
- Do not leave the key where it may be exposed to high temperature or high humidity.
- As your vehicle is equipped with an electronic immobilizer, the electric motor unit is designed so that it will not start if the ID code registered in the immobilizer computer and the key's ID code do not match. Refer to the section entitled “Electronic immobilizer” for details and key usage.

Electronic immobilizer (Anti-theft starting system)

N00509101846

The electronic immobilizer is designed to significantly reduce the possibility of vehicle theft. The purpose of the system is to immobilize the vehicle if an invalid start is attempted. A valid start attempt can only be achieved (subject to certain conditions), using a key “registered” to the immobilizer system. All of the keys provided with your new vehicle have been programmed to the vehicle's electronics.

Electronic immobilizer (Anti-theft starting system)

NOTE

- In the following cases, the vehicle may not be able to recognize the registered ID code from the key. This means the electric motor unit will not start even when the registered key is turned to the “START” position.
- When the key contacts a key ring or other metallic or magnetic object



- When the key grip contacts metal of another key



NOTE

- When the key contacts or is close to other immobilizing keys (including keys of other vehicles)

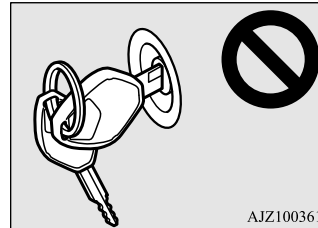

- In cases like the above, move the offending object(s) away from the key and turn the key back to the “ACC” or “LOCK” position. Then try to start the electric motor unit again. If the electric motor unit does not start, contact a certified i-MiEV dealer.
- Electronic immobilizer is not compatible with commercially available remote starting systems. Use of commercially available remote starting systems may result in vehicle starting problems and a loss of security protection.
- A system failure is suspected when the electric motor switch is turned to the “START” position, and the electric motor unit does not start. In such a case, contact a certified i-MiEV dealer.

CAUTION

- Do not make any alterations or additions to the immobilizer system. Alterations or additions could cause failure of the immobilizer.

Replacement keys

5

Only keys that have been programmed to the vehicle electronics can be used to start the vehicle.

If you lose a key, you can order a key from a certified i-MiEV dealer by referring to the key number.

To prevent vehicle theft, the ID code for the vehicle keys must be changed.

Take your vehicle and all remaining keys to a certified i-MiEV dealer to have your ID code changed.

Additional keys

To add a key, you need to register the ID code to the vehicle.

Registering the ID code can be done by a certified i-MiEV dealer. Or it can be done by yourself (except for vehicles sold in Canada).

To register the ID code yourself, follow the “Customer key programming” procedure below.

Electronic immobilizer (Anti-theft starting system)

If you choose to have a certified i-MiEV dealer register the ID code, take your vehicle and any remaining keys to a certified i-MiEV dealer.

NOTE

- You are provided with 2 keys, but you may add up to 6 more keys.

5

Customer key programming (Except for vehicles sold in Canada)

N00562200113

You can program new keys to the system if you have two valid (already registered) keys and blank (not registered) immobilizer key (specially cut for your vehicle at a certified i-MiEV dealer) by doing the following:

1. Insert the first valid key into the ignition and turn the ignition to the “ON” position for 5 seconds.
2. Turn the ignition to the “LOCK” position and remove the first key.
3. Within 30 seconds of turning the first key to the “LOCK” position, insert the second valid key into the ignition and turn it to the “ON” position. About 10 seconds later, the immobilizer indicator will start blinking.

4. When the immobilizer indicator starts blinking, turn the second valid key to the “LOCK” position and remove it. Within 30 seconds after doing so, insert a blank immobilizer key into the ignition and turn it to the “ON” position. Perform this operation no more than 30 seconds after the immobilizer indicator starts blinking. When registration of the ID code is complete, the immobilizer indicator will come on for 3 seconds then go off. If an error occurs, the immobilizer indicator will go off during the procedure.

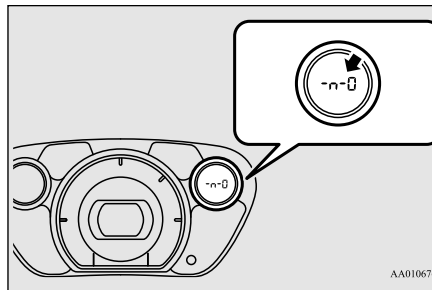

AA0106766

5. If you wish to register another key, perform the process again from step 1.

NOTE

- It is not possible to register a key if:
 - the immobilizer indicator goes off during the procedure

NOTE

- the immobilizer indicator does not come on for 3 seconds after turning the ignition to the “ON” position with a blank immobilizer key
- The procedure will be terminated automatically if:
 - a period of 30 seconds or longer elapses from the moment when the first key is turned to the “LOCK” position to the moment when the second key is turned to the “ON” position
 - a period of 30 seconds or longer elapses from the moment when the second key is turned to the “LOCK” position to the moment when the blank immobilizer key (specially cut for your vehicle at a certified i-MiEV dealer) is turned to the “ON” position
 - more than 20 seconds elapse after the immobilizer indicator starts blinking

General information

N00562300084

Your electronic immobilizer operates on a radio frequency subject to Federal Communications Commission (FCC) Rules (For vehicles sold in U.S.A.) and Industry Canada Rules (For vehicles sold in Canada). This device complies with Part 15 of the FCC Rules and RSS-Gen of the Industry Canada

Keyless entry system

Rules. Operation is subject to the following two conditions.

- This device may not cause harmful interference.
- This device must accept any interference received, including interference that may cause undesired operation.

This digital apparatus does not exceed the Class A limits for radio noise emissions from digital apparatus set out in the Radio Interference Regulations of the Canadian Department of Communications.

CAUTION

- Changes or modifications not expressly approved by the manufacturer for compliance could void the user's authority to operate the equipment.

Keyless entry system

N00509000910

Press the remote control transmitter buttons to lock or unlock the doors and to open the liftgate.

It can also help you signal for attention by setting off the panic alarm.

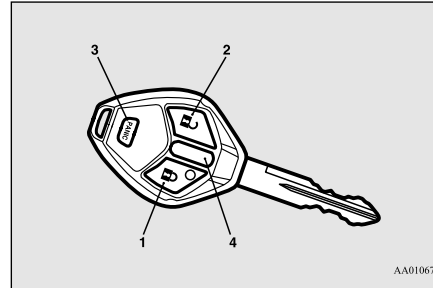

- 1- LOCK (🔒) button
- 2- UNLOCK (🔓) button
- 3- PANIC button
- 4- Indicator light

To lock

Press the LOCK button (1) to lock all the doors and the liftgate.

If the dome light switch is in the door position, the dome light will blink once. The turn signal lights will also blink once.

NOTE

- If you press the LOCK button (1) after locking the doors and the liftgate, the horn will sound once to confirm that they are locked.

To unlock

Press the UNLOCK button (2) to unlock the driver's door only.

Within about 2 seconds, press the UNLOCK button one more time to unlock all the doors and the liftgate.

If the dome light switch is in the door position, the dome light will turn on for about 30 seconds. The turn signal lights will also blink twice.

5

NOTE

- If the UNLOCK button (2) is pressed and no door or liftgate is opened within approximately 30 seconds, relocking will automatically occur (automatic relocking function). The time for automatic relocking can be changed. For details, please contact a certified i-MiEV dealer.
- The door and liftgate unlock function can be set so that all doors and liftgate unlock when the UNLOCK button (2) is pressed once. For details, please contact a certified i-MiEV dealer.

Answerback function

The keyless entry system answerback functions from the horn can each be turned on or off as desired.

Keyless entry system

Horn deactivation/reactivation

The horn answerback function can be set to the following three conditions. Each time the horn answerback function is set, a chime will sound to tell you the condition of the answerback function.

5

Number of chimes	Condition
One chime	The horn will not sound.
Two chimes	The horn will sound.
Three chimes	The horn will sound if the auto light switch is ON (if so equipped).
Four chimes	The horn will sound if the LOCK button is pressed twice quickly.

1. Remove the key from the electric motor switch.
2. Open the driver's door and turn the combination headlights and dimmer switch to the "OFF" position.
3. Press the LOCK button (1) for 4 to 10 seconds and press the UNLOCK button (2) during this time.
4. Release in sequence the UNLOCK and LOCK buttons within 10 seconds of pressing the UNLOCK button in step 3.

5-6 Features and controls

Changing the setting of the turn signal lights answerback function

The turn signal lights answerback function can be changed.

If you want to change the answerback function, please contact a certified i-MiEV dealer for details.

Setting of door unlock function

N00543600105

The door and liftgate unlock function can be set so that all doors and liftgate unlock when the UNLOCK button (2) is pressed once. For details, please contact a certified i-MiEV dealer.

Using the panic alarm

N00543700050

If you are near your vehicle and feel threatened, you may activate the alarm to call attention as follows:

1. Press the PANIC button (3) for more than 1 second.
2. The headlights will blink on and off and the horn will sound intermittently for about 3 minutes.
3. To turn off the alarm, press any button on the remote control transmitter.

Replacement remote control transmitters

N00543800077

Only remote control transmitters programmed with the vehicle's electronics can lock or unlock all doors.

If you lose the remote control transmitter, you can order a remote control transmitter from a certified i-MiEV dealer by referring to the key number.

To prevent vehicle theft, the ID codes for all the remote control transmitters except the one for the lost key must be programmed again.

Take your vehicle and all the remaining remote control transmitters to a certified i-MiEV dealer to have your ID codes programmed again.

Additional remote control transmitters

N00543900065

To add a remote control transmitter, you must already have one registered remote control transmitter.

Registering the ID code can be done by yourself or by a certified i-MiEV dealer. For you to register the ID code yourself, follow the "Customer remote control transmitter programming" procedure below.

Keyless entry system

If you choose to have a certified i-MiEV dealer register the ID code, take your vehicle and all remaining keys to a certified i-MiEV dealer.

NOTE

- You are provided with 2 remote control transmitters, but you may register up to 4 remote control transmitters.

General information

N00546100101

Your keyless entry system operates on a radio frequency subject to Federal Communications Commission (FCC) Rules (For vehicles sold in U.S.A.) and Industry Canada Rules (For vehicles sold in Canada). This device complies with Part 15 of the FCC Rules and RSS-Gen of the Industry Canada Rules. Operation is subject to the following two conditions.

- This device may not cause harmful interference.
- This device must accept any interference received, including interference that may cause undesired operation.

CAUTION

- Changes or modifications not expressly approved by the manufacturer for compliance could void the user's authority to operate the equipment.

Procedure for replacing the remote control transmitter battery

N00544101133

1. Before replacing the battery, remove static electricity from your body by touching a metal grounded object.
2. With the Mitsubishi mark facing up, insert the cloth-covered tip of a flat blade screwdriver into the notch in the remote control transmitter case and use it to open the case.

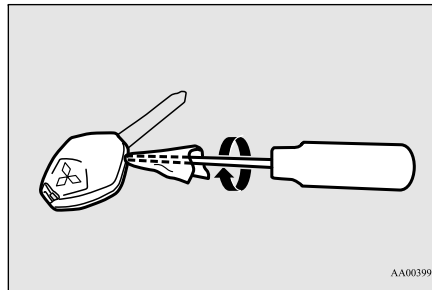

NOTE

- Be sure to perform the procedure with the Mitsubishi mark facing up. If the Mitsubishi mark is not facing up when you open the remote control transmitter case, the buttons may come out.

3. Remove the remote control transmitter from the remote control transmitter case. Then, open the remote control transmitter using the method described in step 2.

5

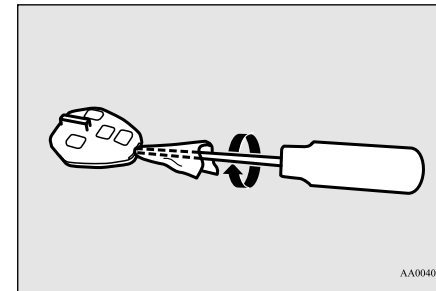

4. Remove the old battery.
5. Install a new battery with the + side (A) down.

Door locks

5

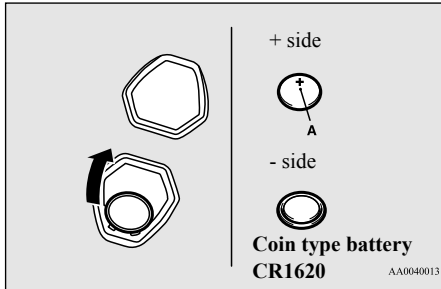

6. Close the remote control transmitter firmly.
7. Place the remote control transmitter in the remote control transmitter case, then securely close the remote control transmitter case.
8. Check the keyless entry system to see that it works.

NOTE

- A certified i-MiEV dealer can replace the battery for you if you prefer.

CAUTION

- When the remote control transmitter case is opened, be careful to keep water, dust, etc. out. Also, do not touch internal components.

Door locks

N00509200534

WARNING

- Make sure all doors are tightly closed and locked while driving.
- Locked doors, in combination with the use of seat belts, can help reduce the risk of ejection in an accident.
- Locked doors can help keep passengers, especially small children, from opening doors and falling out of moving vehicles.
- Locked doors can help prevent outsiders from gaining access to your vehicle when you slow down or come to a stop.
- Lock your vehicle whenever you leave it. Children who get into unlocked vehicles may not be able to get out. Children trapped inside vehicles can quickly be overcome by heat and suffer serious injury or death due to heat stroke.
- Never leave children unattended inside a vehicle. In addition to the risk of heat stroke, children can activate switches and controls, resulting in an injury or fatal accident.

To lock or unlock the door with the key

Turn the key toward the front of the vehicle to lock the door. After checking that the door is locked, turn the key back to the center and remove it.

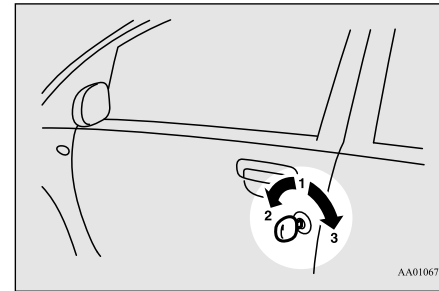

- 1- Insert or remove the key
- 2- Lock
- 3- Unlock

To lock or unlock the door from the inside

Move the lock knob to the lock position to lock the door.
All doors should be kept locked while driving.

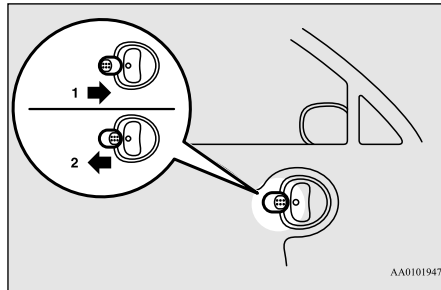

- 1- Lock
- 2- Unlock

The driver's door can be unlocked without using the lock knob by pulling on the inside door handle.

To lock the door without using the key

- 1. Move the inside lock knob to the locked position.

- 2. Be sure the keys are not inside the vehicle. Close the door.

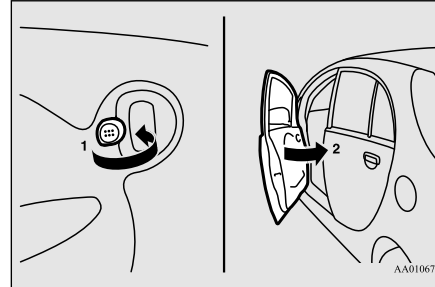

Key reminder buzzer

N00549600240

If you open the driver's door while the key is in the "LOCK" or "ACC" position, a tone will sound, reminding you to remove the key.

Lock out protection

N00549700179

If the key is in the electric motor switch when you push the lock knob forward with the driver's door or passenger's door open, the lock knob will automatically return to the unlocked position.

Power door locks

N00509300607

NOTE

- When locking or unlocking with the key on the driver's door, only the driver's door will lock or unlock.
- Repeated continuous operation between lock and unlock could activate the power door locking systems built-in protection circuit and prevent the system's from operating. If this occurs, wait about 1 minute before operating the power door lock switch.

Child safety locks for rear door

To lock and unlock by the power door lock switch

5

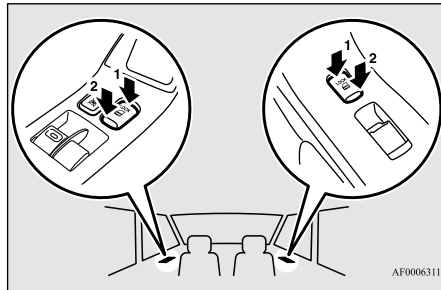

- 1- Lock
- 2- Unlock

All of the doors and the liftgate can be locked or unlocked by operating the power door lock switch on the driver's or the passenger's door.

To unlock the doors and liftgate

N0056340095

You can select the functions to unlock the doors and liftgate either using the electric motor switch position or using the selector lever position.

These functions are not activated when the vehicle is shipped from the factory. To activate or deactivate these functions, please contact a certified i-MiEV dealer.

5-10 Features and controls

Using the selector lever position

All doors and the liftgate will unlock when the selector lever is moved to the "P" (PARK) position with the electric motor switch in the "ON" position.



Child safety locks for rear door

N00509400288

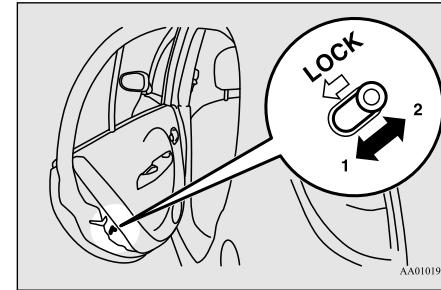

- 1- To lock
- 2- To release

Child safety locks help prevent rear passengers, especially children, from opening the rear door using the inside door handle.

A lock lever for the child safety lock is provided on each rear door.

When the lever is in the lock position (1), the rear door cannot be opened using the inside door handle.

To open the rear door when the child safety lock lever is in the lock position, pull the outside door handle.

When the lever is in the release position (2), the child safety lock is released and the rear

Liftgate

door can be opened using the inside door handle.

WARNING

- Always keep the doors tightly closed and locked when driving. An unlocked door may be accidentally opened by a passenger, especially by a child who could fall out. Also, if the doors are not locked, there is a greater risk of someone being thrown from the vehicle in an accident.

Liftgate

N00510101266

WARNING

- When opening and closing the liftgate, make sure that there are no people nearby and be careful not to hit your head or pinch your hands, neck, etc.
- If snow or ice has accumulated on the liftgate, remove it before opening the liftgate. Otherwise the liftgate may abruptly close due to the weight of the snow or ice.
- When opening the liftgate, always fully open it. A partially opened liftgate can unexpectedly close due to its own weight.
- When the vehicle is parked on a slope, the effort required to open or close the liftgate may be greater or less than expected. The liftgate may also open or close more quickly.

CAUTION

- To avoid damage to the liftgate, make sure the area above and behind the liftgate is clear before opening it.

To open

After unlocking the liftgate, push the switch (A) and pull up the liftgate.

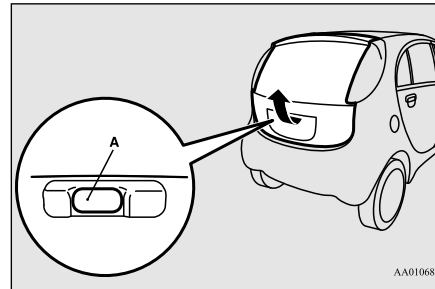

AA0106809

NOTE

- If you do not open the liftgate immediately after pulling the handle, the liftgate can not be lifted. If this happens, pull the handle again and lift the liftgate.
- The liftgate cannot be opened when the battery is flat or disconnected.

To close

Pull the liftgate grip (A) downward as illustrated. Gently push the upper gate from the outside with enough force so that it is completely closed. Always ensure the liftgate is securely closed.

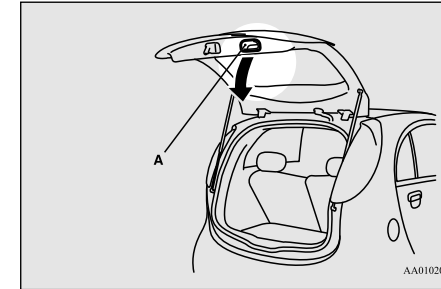

AA0102045

CAUTION

- To avoid injuring your hand or arm, do not attempt to close the liftgate the gate grip (A).
- Before starting the vehicle, be sure to confirm that the liftgate is locked. If the liftgate opens while driving the vehicle, objects stored in the luggage compartment could fall out into the road.
- When closing the liftgate, always ensure that everybody removes their hands and fingers from the liftgate opening.

5

Theft-alarm system

NOTE

- Gas struts (B) are installed to support the liftgate. To prevent damage or faulty operation.
- Do not hold the gas struts when closing the liftgate.
- Also, do not push or pull on the gas struts.
- Do not attach any plastic material, tape, etc., to the gas struts.
- Do not tie anything, etc., around the gas struts.
- Do not hang any objects on the gas struts.

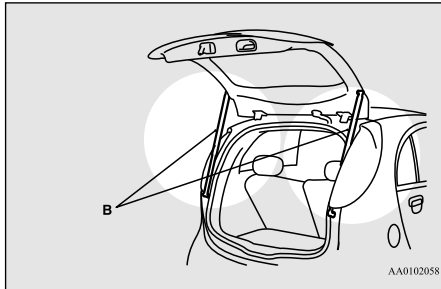

Theft-alarm system

N00510200244

The theft-alarm system is designed to provide protection from unauthorized entry into the vehicle. This system is operated in three stages: the first is the “armed” stage, the sec-

5-12 Features and controls

ond is the “alarm” stage, and third is the “disarmed” stage. If triggered, the system provides both audible and visual alarm signals.

CAUTION

- Do not modify or add parts to the theft-alarm system. Doing so could cause the theft-alarm to malfunction.

Armed stage

Park the vehicle and stop the electric motor unit. Arm the system as described below.

1. Remove the key from the electric motor switch.
2. Lock all doors and the liftgate by using the keyless entry system.

Arm the system and leave

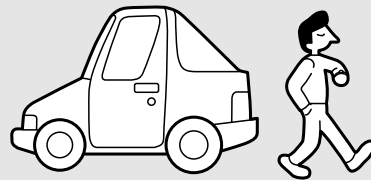

At this time, the theft-alarm indicator (A) in the meter cluster flashes for confirmation.

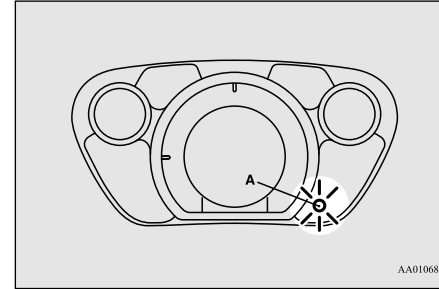

3. The system has entered the armed stage after about 20 seconds, when the theft-alarm indicator flashing becomes slower. The theft-alarm indicator continues to flash while the system is in the armed stage.

NOTE

- The system will be disarmed if, while the theft-alarm indicator is illuminated, all doors and the liftgate are unlocked by using the keyless entry system.
- The system will be disarmed if, while the theft-alarm indicator is illuminated, the electric motor switch is turned to the “ON”.
- The system will not be armed if a door or the liftgate is not completely closed. If this happens, rearm the system as described above.

Theft-alarm system

NOTE

- The theft-alarm system can be activated when people are riding inside the vehicle or when the windows are open. To prevent accidental activation of the alarm, do not set the system to the system armed mode while people are riding in the vehicle.
- If the answerback function (flashing of the turn signal lights by locking and unlocking the doors and the liftgate) is deactivated, the turn signal lights do not flash after the locking and unlocking operation.
For information on the answerback function, refer to “Keyless entry system” on pages 5-5.

Alarm stage

The alarm will be activated if the following occurs while the vehicle is parked and the system is armed.

- One of the doors and the liftgate is opened without using the keyless entry system.

Type of alarm

When the alarm is activated:

1. The headlights blink on and off for 3 minutes.
After 3 minutes the headlights automatically shut off.

2. The horn will sound intermittently for 3 minutes.

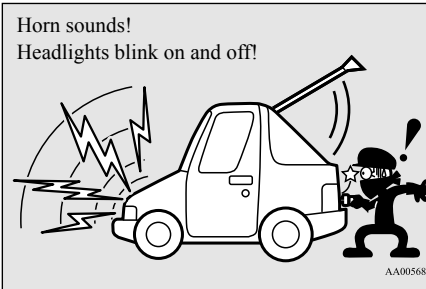

NOTE

- The alarm will continue to operate for 3 minutes. At the end of that period, the alarm will automatically shut off to save battery power. The system will then be rearmed until the proper disarming step is taken.
- The alarm will resume if unauthorized actions are taken again, even if the alarm has stopped.

Alarm deactivation

The alarm can be deactivated in the following ways.

- By using the keyless entry system to lock or unlock the doors and liftgate.

- Turn the electric motor switch to the “ON” position.

Disarmed stage

The system will be disarmed if the following operation is performed.

5

- The electric motor switch is turned to the “ON” position.
- All doors and the liftgate are unlocked by using the keyless entry system.

Disarm...by using the keyless entry system

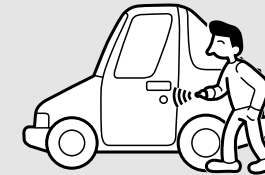

NOTE

- If the UNLOCK button on the remote control transmitter is operated when all doors and the liftgate are closed and no door is opened within approximately 30 seconds, re-arming will automatically occur.

Power window control

NOTE

- The amount of time after unlocking until the vehicle relocks automatically can be adjusted. See a certified i-MiEV dealer for details.
- Once the system has been disarmed, it cannot be rearmed except by repeating the arming procedure.

5

Testing the theft-alarm system

Use the following procedure to test the system:

1. Lower the driver's window.
2. Arm the system as explained in "Armed stage".
3. Make sure that the theft-alarm indicator comes on and flashes for approximately 20 seconds.
4. Wait a few seconds and then unlock the driver's side door by using the inside door lock knob. Open the door.
5. Make sure that the horn sounds intermittently and the headlights blink when a door is opened.
6. Disarm the system by unlocking all doors and the liftgate by using the keyless entry system.

Power window control

N00510801410

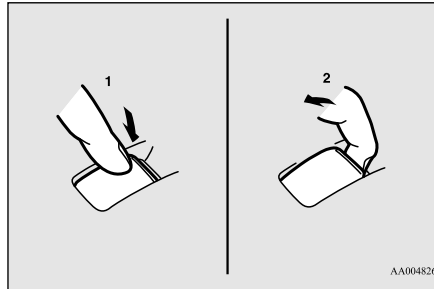

- 1- Open (down)
- 2- Close (up)

AA0048266

NOTE

- Never try to operate the main switch and sub-switch in different directions at the same time. This will freeze the window in position.
- Operating the power windows repeatedly with the electric motor unit stopped will run down the 12V starter battery. Use the window switches only while the electric motor unit is operating.
- Do not turn the electric motor switch to the "ON" position during quick charging. Doing so will stop quick charging.

WARNING

- Before operating the power windows, make sure that nothing can be trapped (head, hands, fingers, etc.) in the window.
- Never leave the vehicle without carrying the key.
- Never leave children or unreliable adults unattended inside the vehicle.

Power window control

Main switch

N00548700127

The main switch located on the driver's door can be used to operate all the windows. A window can be opened or closed by operating the corresponding switch. Press the switch down to open the window, and pull up the switch to close it. If the driver's door window switch is fully pressed down, the driver's door window automatically opens completely. If you want to stop the window movement, operate the switch lightly in the reverse direction.

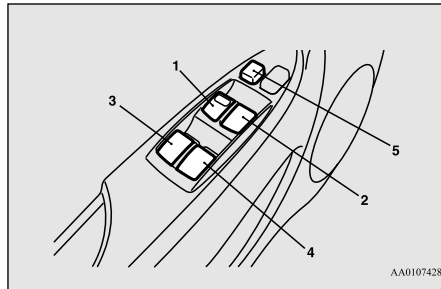

- 1- Driver's door window switch
- 2- Front passenger door window switch
- 3- Left rear door window switch
- 4- Right rear door window switch
- 5- Lock switch

Sub switch

N00548800115

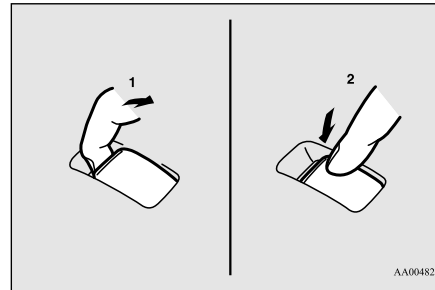

- 1- Close
- 2- Open

Each sub-switch can be used for its own passenger door window, unless the driver's window lock switch is activated.

Power window timer function

N00548900145

The power windows can be run up or down when the electric motor switch is in the "ON" position.

The door windows can be opened or closed for a 30-second period after the electric motor switch is turned to the "ACC" or "LOCK" position. However, once the driver's door or the front passenger's door is opened, the power windows cannot be operated.

Lock switch

N00549000156

When this switch is in the lock mode, the passenger door switches cannot be used to open or close the door windows, and the main switch will open or close only the driver's door window. To unlock the switch, press it again.

5

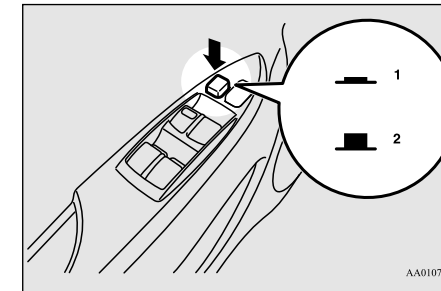

- 1- Lock
- 2- Unlock

⚠ WARNING

- Before driving with a child in the vehicle, be sure to lock the window switch to make it inoperative. Children tampering with the switch could easily trap their hands or heads in the window.

Parking brake

Parking brake

N00511400386

To park the vehicle, first bring it to a complete stop, fully engage the parking brake, and set the selector lever to “P” (PARK) position.

5

To apply

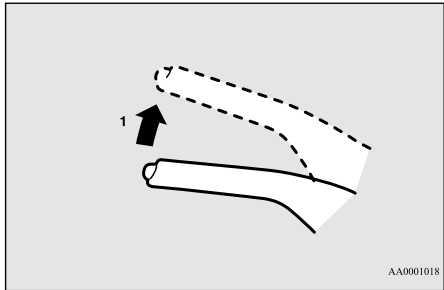

- 1- Pull the lever up without pushing the button at the end of hand grip.

When the parking brake is set and the electric motor switch is in the “ON” position, the brake warning light in the instrument cluster will come on.

Before driving, be sure to release the parking brake.

To release

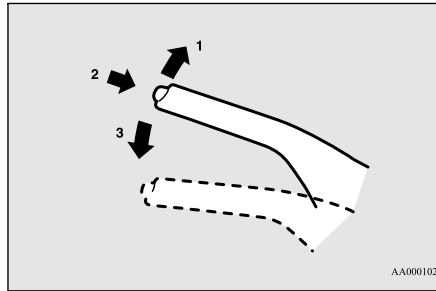

- 1- Pull the lever up slightly.
- 2- Press and hold the button at the end of the hand grip.
- 3- Push the lever downward.

When parking on a hill, apply the parking brake and turn the front wheels toward the curb on a downhill grade, away from the curb on an uphill grade.

CAUTION

- Before driving, be sure that the parking brake is fully released and brake warning light is off.
- If a vehicle is driven without releasing the parking brake, the brakes will be overheated, resulting in ineffective braking and possible brake failure.

Inside rearview mirror

N00511600287

Adjust the inside rearview mirror only after making any seat adjustments so as to have a clear view to the rear of the vehicle.

WARNING

- Do not attempt to adjust the inside rearview mirror while driving. This can be dangerous.
- Be sure to adjust the mirror before driving.

Adjust the inside mirror to maximize the view through the rear window.

To adjust the vertical mirror position

It is possible to move the mirror up and down to adjust its position.

Outside rearview mirrors

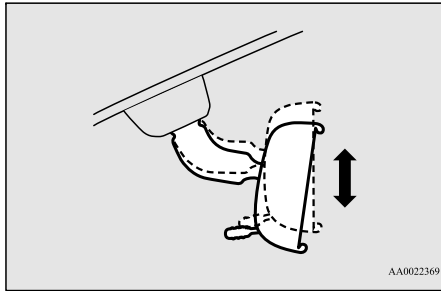

To reduce the glare

The day/night knob (A) at the bottom of the mirror can be used to adjust the mirror to reduce the glare from the headlights of vehicles behind you during night driving.

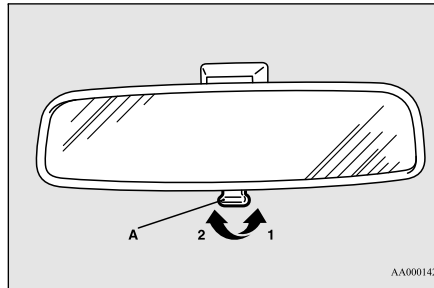

- 1- Daytime position
- 2- Night position

To adjust the mirror position

It is possible to move the mirror up/down and left/right to adjust its position.

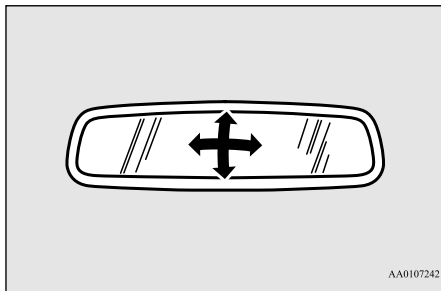

⚠ WARNING

- Do not attempt to adjust the outside rearview mirrors while driving. This can be dangerous.
Be sure to adjust the mirrors before driving.
- Your front passenger's side mirror is convex. The objects you see in the mirror will appear in a regular flat mirror. Do not use this mirror to estimate the distance of vehicles following you when changing lanes.

5

Outside rearview mirrors

N00512200222

Adjust the outside rearview mirrors only after making any seat adjustments so you have a clear view to the rear of the vehicle.

Electric motor switch

To adjust the mirror position

The outside rearview mirrors can be adjusted when the electric motor switch is in the “ON” or “ACC” position.
Move the lever (A) to the same side as the mirror you wish to adjust.

5

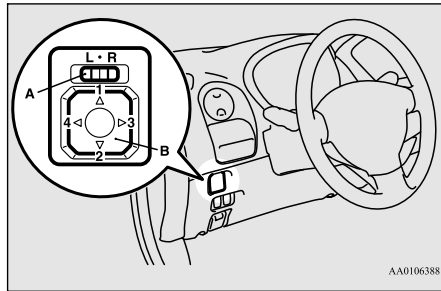

L- Left outside mirror adjustment
R- Right outside mirror adjustment

Press the switch (B) to adjust the mirror position.

- 1- Up
- 2- Down
- 3- Right
- 4- Left

NOTE

- After adjusting, return the lever to the “•” (off) position.

To fold the mirror

The outside mirror can be folded in toward the side window to prevent damage when parking in tight locations.

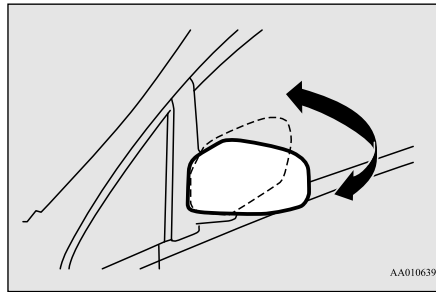

Heated mirror

N00549301231

When the rear window defogger switch is pressed, the outside rearview mirrors are defogged or defrosted. Current will flow through the heater element inside the mirrors, thus clearing away frost or condensation.
The indicator light (C) will illuminate while the defogger is on.

The heater will be turned off automatically in about 20 minutes.

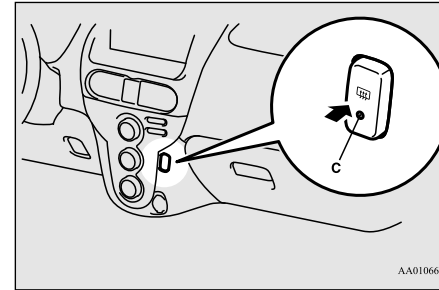

Electric motor switch

N00571500011

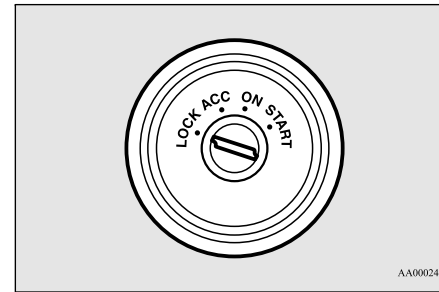

Electric motor switch

LOCK

The steering wheel is locked. The key can be inserted and removed only when the switch is in this position.

ACC

The ready indicator is not illuminated, but the audio system and other electric devices can be operated.

ON

The electric motor unit is running, and all the vehicle's electrical devices can be operated.

START

The electric motor unit operates. After the electric motor unit has started, release the key and it will automatically return to the "ON" position.

NOTE

- Your vehicle is equipped with an electronic immobilizer. To start the electric motor unit, the ID code which the transponder inside the key sends must match the one registered to the immobilizer computer. (Refer to "Electronic immobilizer" on page 5-2.)

ACC power auto-cutout function

N00573800021

After about 30 minutes has elapsed with the electric motor switch in the "ACC" position, the function automatically cuts out the power for the audio system and other electric devices that can be operated with that position.

When the electric motor switch is turned from the "ACC" position, the power is supplied again to those devices.

NOTE

- It is possible to modify functions as follows:
 - The ACC power auto-cutout function can be deactivated by a certified i-MiEV dealer.

To remove the key

N00571600025

When removing the key, first set the selector lever to the "P" (PARK) position, and then turn the key to the "LOCK" position and remove it.

5

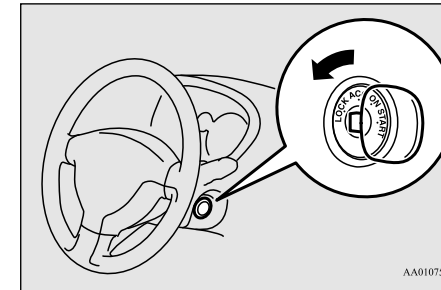

AA0107590

CAUTION

- Do not remove the key from the electric motor switch while driving. The steering wheel will lock, causing loss of control.
- If the ready indicator is turned off while driving, the power brake booster will stop functioning and braking efficiency will be reduced. Also, the power steering system will not function and it will require greater effort to manually steer the vehicle.
- Do not leave the key in the "ON" position for a long time when the electric motor unit is not running. This will cause the 12V starter battery to run down.

Steering wheel lock

Key reminder buzzer

N00571700013

If the driver's door is opened while the electric motor switch is in the "LOCK" or "ACC" position, a tone will sound.

5 Steering wheel lock

N00512500209

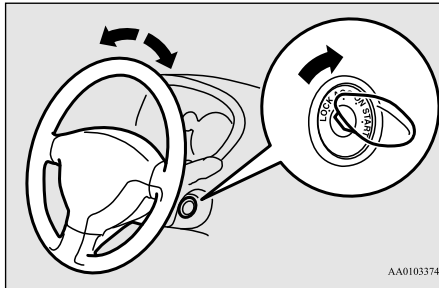

AA0103374

To lock

Remove the key at the "LOCK" position. Turn the steering wheel until it is locked.

To unlock

Turn the key to the "ACC" position while moving the steering wheel slightly.

5-20 Features and controls

CAUTION

- Remove the key when leaving the vehicle.
- If your vehicle needs to be towed, turn the key to the "ACC" position to unlock the steering wheel.

NOTE

- If the front wheels are turned, the anti-theft lock may sometimes make it difficult to turn the key from "LOCK" position to "ACC" position. Firmly turn the steering wheel to the left or to the right as you turn the key.

Starting the electric motor unit

N00571800014

CAUTION

- Never attempt to start the electric motor unit by pushing or pulling the vehicle.

1. Make sure all occupants are properly seated with seat belts fastened.
2. Insert the key.
3. Make sure the parking brake is applied.
4. Press and hold the brake pedal down with your right foot.
5. Make sure the selector lever is in the "P" (PARK) position.

6. Turn the key to the "ON" position and make certain that all warning lights are functioning properly before starting the electric motor unit.

7. Turn the key to the "START" position for one to two seconds, and slowly return it to its original position. When you hear the startup sound and the ready indicator comes on, startup of the electric motor unit is complete.

Electric motor reminder

If the driver's door is opened while the key is in the "ON" position, the electric motor reminder buzzer sounds intermittently to remind the key is in the electric motor switch.

Selector lever

Selector lever

N0058360022

Selector lever operation

N0058370023

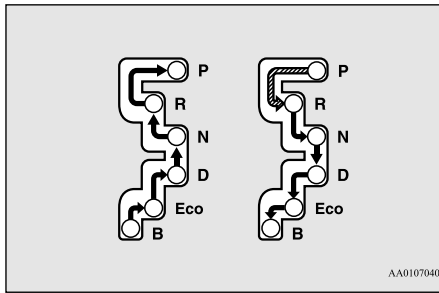

AA0107040

	While depressing the brake pedal, move the selector lever through the gate.
	Move the selector lever through the gate.

WARNING

- Always depress the brake pedal when shifting the selector lever into another position from the “P” (PARK) or “N” (NEUTRAL) position.
- Never put your foot on the accelerator pedal while shifting the selector lever from the “P” (PARK) or “N” (NEUTRAL) position.

NOTE

- To avoid erroneous operation, move the selector lever firmly into each position and briefly hold it there. Always check the position shown by the selector lever position display after moving the selector lever.
- If the brake pedal is not depressed and held, the shift-lock device activates to prevent the selector lever from being moved from the “P” (PARK) position.

Selector lever position indicator

N0058380024

When the electric motor switch is turned to the “ON” position, the current position of the selector lever is indicated on the instrument cluster.

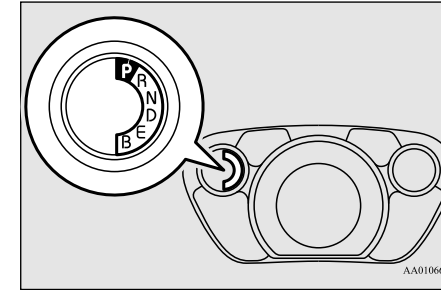

AA0106652

5

When the selector lever position indicator flashes while you are driving, there could be a malfunction in the transmission.

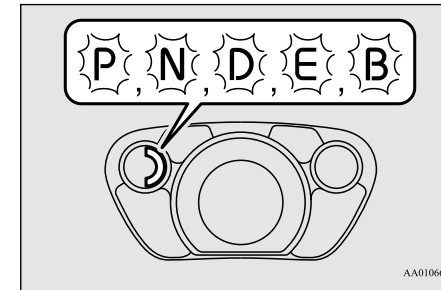

AA0106665

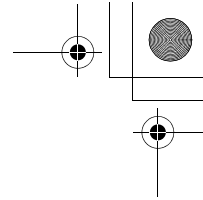
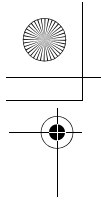

Selector lever

5

CAUTION

- If the selector lever position indicator blinks while you are driving, it is likely that a safety device is operating because of a malfunction in the transmission system. We recommend you to have your vehicle inspected as soon as possible.
- The selector lever position indicator warning function does not operate with the selector lever in the “R” (REVERSE) position.

Selector lever positions

N00583900025

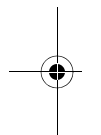

“P” PARK

This position locks the transmission to prevent the vehicle from moving. The electric motor unit can be started from the “PARK” position.

WARNING

- Do not leave the vehicle with the electric motor switch in the “ON” position. The vehicle can move suddenly. To be sure the vehicle will not move, even when you are on level ground, always set the parking brake and move the selector lever to the “P” (PARK) position.

“R” REVERSE

This position is to back up.

CAUTION

- Never move the selector lever to the “P” (PARK) or “R” (REVERSE) position while the vehicle is in motion. If the lever is moved to the “P” (PARK) or “R” (REVERSE) position while the vehicle is in motion, the transmission could be damaged.

“N” NEUTRAL

Use this position only when the vehicle is stationary for an extended length of time while driving, such as in a traffic jam.

WARNING

- Never move the selector lever to the “N” (NEUTRAL) position while the vehicle is in motion. You will lose regenerative braking. In addition, a serious accident could occur if the selector lever were inadvertently moved into the “P” (PARK) position or “R” (REVERSE) position.

“D” DRIVE

Use this position for normal driving.

CAUTION

- To avoid transmission damage, never shift into the “D” (DRIVE) position from the “R” (REVERSE) position while the vehicle is in motion.

“ECO” ECO MODE

Use this position when you desire to limit power consumption and/or when moderate regenerative braking is required.

“B” REGENERATIVE BRAKE MODE

Use this position when strong regenerative braking is required, such as on a steep downhill.

Refer to “Regenerative braking” on page 3-3. Refer to “When driving downhill” on page 6-5.

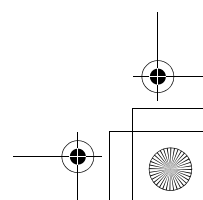
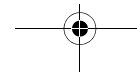
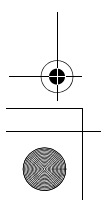
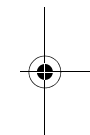

WARNING

- While driving on a slippery road, do not use the “B” position. Abruptly releasing the accelerator pedal can apply strong regenerative braking causing the vehicle to skid which could result in an accident.

NOTE

- When the main drive lithium-ion battery level is full or nearly full, or the main drive lithium-ion battery temperature is too high or too low, the regenerative braking force may be reduced and stronger effort may be required to operate the brakes.

Operation of the transmission

N0058400023

CAUTION

- Before selecting a position with the electric motor unit running and the vehicle stationary, fully depress the brake pedal to prevent the vehicle from creeping. The vehicle will begin to move as soon as the transmission is engaged, the brakes should only be released when you are ready to drive away.
- Depress the brake pedal with the right foot at all times. Using the left foot could cause driver movement delay in case of an emergency.

CAUTION

- Operating the accelerator pedal while the other foot is resting on the brake pedal will affect braking efficiency and may cause premature wear of brake pads.

Waiting

N00584100024

For short waiting periods, such as at traffic signals the vehicle can be left in selector lever position and held stationary with the service brake.

For longer waiting periods with the electric motor unit running, place the selector lever in the “N” (NEUTRAL) position and apply the parking brake, while holding the vehicle stationary with the service brake.

CAUTION

- Never hold the vehicle stationary on a hill with the accelerator. Always apply the parking brake and/or service brake.

Parking

N00584200025

To park the vehicle, first bring it to a complete stop, fully engage the parking brake, and then move the selector lever to the “P” (PARK) position.

Acoustic vehicle alerting system (AVAS)

If you are going to leave the vehicle unattended, always switch off the electric motor unit and carry the key.

NOTE

- On a slope, be sure to apply the parking brake before moving the selector lever to the “P” (PARK) position. If you move the selector lever to the “P” (PARK) position before applying the parking brake, it may be difficult to disengage the selector lever from the “P” (PARK) position when next you drive the vehicle, requiring application of a strong force to the selector lever to move from the “P” (PARK) position.

5

Acoustic vehicle alerting system (AVAS)

N00571900028

While driving at low speeds, such as in parking lots, the acoustic vehicle alerting system (AVAS) alerts people who may not hear your vehicle approaching.

The system sounds when the vehicle speed is approximately 22 mph (35 km/h) or less. The acoustic vehicle alerting system (AVAS) will operate under the following conditions:

- When the vehicle speed is approximately 2 mph (3 km/h) or less and the brake pedal is not depressed.

Service brake

- When the vehicle speed is approximately 2-22 mph (3-35 km/h).

The system will not operate under the following conditions:

- When the vehicle speed is approximately 2 mph (3 km/h) or less and the brake pedal is depressed.
- When the vehicle speed is approximately 22 mph (35 km/h) or more.
- When the selector lever is in the “P” (PARK) position.

5

⚠ WARNING

- Always pay special attention to pedestrians. Even if the acoustic vehicle alerting system (AVAS) sounds, pedestrians may not notice your vehicle.

Under normal conditions, the indicator light in the instrument cluster illuminates when the electric motor switch is turned to the “ON” position and goes off a few seconds later. Always confirm the indicator light goes off before driving.

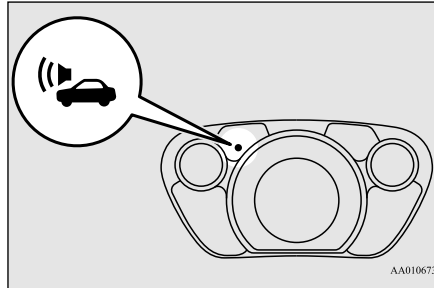

📖 NOTE

- If the indicator light blinks, turn the electric motor switch back to the “LOCK” position and again turn the switch to the “ON” position. It is not a malfunction if the indicator light goes off. If the indicator light blinks again, however, have the vehicle inspected at a certified i-MiEV dealer as soon as possible.

Service brake

N00517500305

Brake pedal

Overuse of the brake can cause poor brake response and premature wear of the brake pads.

⚠ WARNING

- Do not leave any objects near the brake pedal or let a floor mat slide under it; doing so could prevent the full pedal stroke that would be necessary in an emergency. Make sure that the pedal can be operated freely at all times. Make sure the floor mat is securely held in place.

⚠ CAUTION

- It is important not to drive the vehicle with your foot resting on the brake pedal when braking is not required. This practice can result in very high brake temperatures, premature pad wear, and possible damage to the brakes.

Power brakes

N00517600423

Your vehicle is equipped with power brakes for more braking force with reduced brake pedal effort.

Your brakes are designed to operate at full capacity, even if the power assist is lost.

If the power assist is lost, the effort needed to press the brake pedal is greater.

If you should lose the power assist for some reason, the brakes will still work.

If the power brake unit or either of the two brake hydraulic systems stop working prop-

Brake assist system

erly, the rest of the brake system will still work, but the vehicle will not slow down as quickly.

You will know this has happened if you find you need to depress the brake pedal down further, or harder when slowing down or stopping, or if the brake warning light comes on.

WARNING

- Never turn off the electric motor switch while driving. Doing so will result in a loss of power assist for the brakes and steering, increasing the effort required to steer and brake the vehicle.

NOTE

- At times, you may hear the brake electric vacuum pump for the power brakes operating when the ready indicator illuminates or the brake pedal is depressed. This sound is normal and does not indicate a problem.

Brake pad wear alarm

N00532500162

The disc brakes have an alarm that makes a metallic squeal when the brake pads have worn down enough to need service. If you hear this sound, have the brake pads replaced at a certified i-MiEV dealer.

WARNING

- Driving with worn brake pads will make it harder to stop, and can cause an accident.

Brake assist system

N00567300063

The brake assist system is a device assisting drivers who cannot depress the brake pedal firmly such as in emergency stop situations and provides greater braking force.

If the brake pedal is depressed suddenly, the brakes will be applied with more force than usual.

CAUTION

- The brake assist system is not a device designed to exercise braking force greater than its capacity. Make sure to always keep a sufficient distance between vehicles in front of you without relying too much on the brake assist system.

NOTE

- Once the brake assist system is operational, it maintains great braking force even if the brake pedal is lightly released. To stop its operation, completely remove your foot from the brake pedal.

NOTE

- The brake assist system may become operational when the brake pedal is fully depressed even if it has not been depressed suddenly.
- When the brake assist system is in use while driving, you may feel as if the depressed brake pedal is soft, the pedal moves in small motions in conjunction with the operation noise, or the vehicle body and the steering wheel vibrate. This occurs when the brake assist system is operating normally and does not indicate faulty operation. Continue to depress the brake pedal.
- You may hear an operation noise when the brake pedal is depressed suddenly while stationary. This does not indicate a malfunction and the brake assist system is operating normally.

Anti-lock braking system

N00517900325

The anti-lock braking system helps prevent the wheels from locking up when braking. This helps you keep control of your vehicle and its direction.

Anti-lock braking system

Driving hints

5

- When using the anti-lock brakes (sudden braking), steering is slightly different from normal driving conditions. Use the steering wheel carefully.
- Always keep a safe distance from the vehicle in front of you. Even if your vehicle is equipped with the anti-lock braking system, leave a greater braking distance when:
 - Driving on gravel or snow-covered roads.
 - Driving on uneven road surfaces.
- Operation of anti-lock braking system is not restricted to situations where brakes are applied suddenly. This system may also prevent the wheels from locking when you drive over manholes, steel roadwork plates, road markings, or any uneven road surface.
- When the anti-lock braking system is in use, you may feel the brake pedal vibrating and hear a unique sound. You may also feel as if the pedal resists being pressed.
In this situation, simply hold the brake pedal down firmly. Do not pump the brake, which will result in reduced braking performance.

- An operation noise may be emitted from under the hood in the following situations. The sound is associated with checking the operations of the anti-lock braking system.
 - At this time, you may feel a shock from the brake pedal if you depress it. These do not indicate a malfunction.
 - When the electric motor switch is set to the “ON” position.
 - When the vehicle is driven for a while after the electric motor is turned on.
- The ABS can be used after the vehicle has reached a speed over approximately 6 mph (10 km/h). It stops working when the vehicle slows below approximately 3 mph (5 km/h).

CAUTION

- The anti-lock braking system cannot prevent accidents. It is your responsibility to take safety precautions and to drive carefully.
- Be sure to use the specified type and size of tire on all four wheels. Otherwise, the ABS may not work properly.
- Do not install any aftermarket limited slip differential (LSD) on your vehicle. The ABS may stop functioning properly.

Anti-lock braking system warning light

N00531600661

This light comes on in the event of a malfunction in the anti-lock braking system. It will also come on as a self-check for a few seconds when the electric motor switch is turned to the “ON” position. Always make sure that the light goes out before beginning to drive.

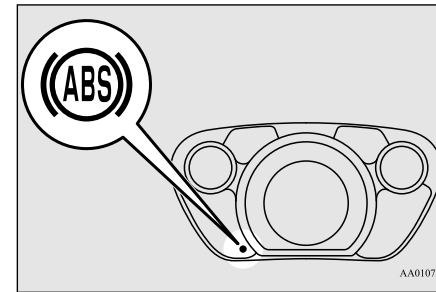

AA0107226

CAUTION

- If the anti-lock braking system warning light comes on and stays on after starting the electric motor unit or while driving, it means that the anti-lock braking system is not working and that only the standard brake system is available. (The standard brake system will still work properly.) If this happens, take your vehicle to a certified i-MiEV dealer as soon as possible.

If the warning light illuminates while driving

N00531700590

If only the ABS warning light illuminate

Avoid hard braking and high-speed driving. Stop the vehicle in a safe place, put the selector lever to the “P” (PARK) position and turn off the electric motor unit.

Restart the electric motor unit and check to see whether the light goes out after a few minutes driving; if it then remains off during driving, there is no problem.

However, if the warning light does not disappear, or if it comes on again when the vehicle is driven, we recommend you to have the vehicle checked.

If the ABS warning light and brake warning light illuminate at the same time

The ABS and brake force distribution function may not work, so hard braking could make the vehicle unstable.

Avoid hard braking and high-speed driving. Stop the vehicle in a safe place and we recommend you to have the vehicle checked.

NOTE

- The warning light may be illuminated when the electric motor unit is started while the 12V starter battery voltage is low, but this is not an ABS malfunction. When the main drive lithium-ion battery is charged, the 12V starter battery is charged at the same time, and the warning light will go out. If the warning light does not go out or illuminates from time to time even after the battery is charged, take your vehicle to a certified i-MiEV dealer and have the system checked as soon as possible.
- After driving on snow or icy roads, remove any snow and ice which may have been left around the wheels. On vehicles that have an anti-lock braking system, be careful not to damage the wheel speed sensors (A) or the cables located at each wheel.

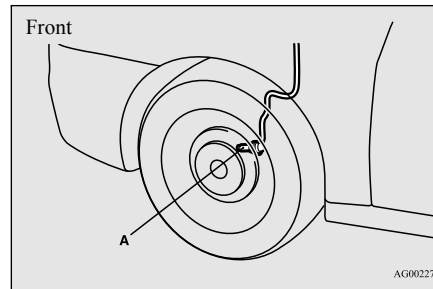

Electric power steering system (EPS)

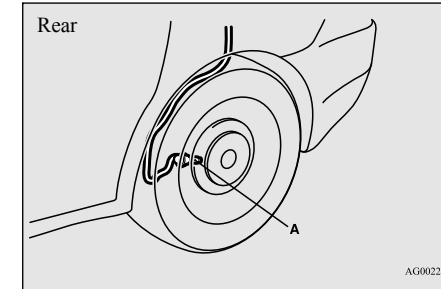

5

Electric power steering system (EPS)

N00568400058

The power steering system operates while the electric motor unit is running. It helps reduce the effort needed to turn the steering wheel.

The power steering system has mechanical steering capability in case the power assist is lost. If the power assist is lost for some reason, you will still be able to steer your vehicle, but you will notice it takes much more effort to steer. If this happens, have your vehicle inspected at a certified i-MiEV dealer.

Active stability control (ASC)

WARNING

- Do not turn the key from the ON position while the vehicle is moving. Stopping the electric motor unit would make the steering wheel extremely hard to turn, possibly resulting in an accident.

5

NOTE

- During repeated full-lock turning of the steering wheel (for example, while you are maneuvering the vehicle into a parking space), a protection function may be activated to prevent overheating of the power steering system. This function will make the steering wheel gradually harder to turn. In this event, limit your turning of the steering wheel for a while. When the system has cooled down, the steering effort will return to normal.
- If you turn the steering wheel while the vehicle is stationary with the headlights on, the headlights may become dim. This behavior is not abnormal. The headlights will return to their original brightness after a short while.

Electric power steering system warning light

N00574400024

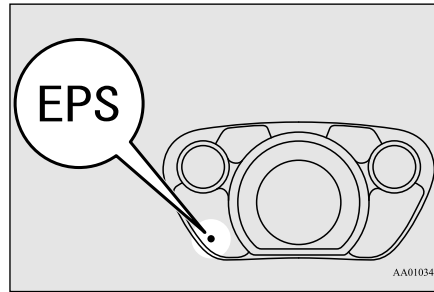

If there is a malfunction in the system, the warning light will come on.

Under normal conditions, the warning light comes on when the electric motor switch is turned to the “ON” position and goes off a few seconds later.

CAUTION

- If the warning light appears while the electric motor unit is running, have the vehicle inspected at a certified i-MiEV dealer as soon as possible. It may become harder to turn the steering wheel.

Active stability control (ASC)

N00559100163

The active stability control (ASC) takes overall control of the anti-lock braking system, traction control function and skid control function to help maintain the vehicle's control. Also refer to the following pages on the anti-lock braking system, traction control function and skid control function.

Anti-lock braking system (ABS) → P.5-25

Traction control function → P.5-29

Skid control function → P.5-29

CAUTION

- Do not over-rely on the ASC. Even the ASC cannot prevent the natural laws of physics from acting on the vehicle. This system, like any other system, has limits and cannot help you to maintain traction and control of the vehicle in all circumstances. Reckless driving can lead to accidents. It is the driver's responsibility to drive carefully. This means taking into account the traffic, road and environmental conditions.
- Be sure to use the specified type and size of tire on all four wheels. Otherwise, the ASC may not work properly.
- Do not install any aftermarket limited slip differential (LSD) on your vehicle. The ASC may stop functioning properly.

Active stability control (ASC)

ASC, momentarily press the ASC OFF switch; the  indicator is turned off.

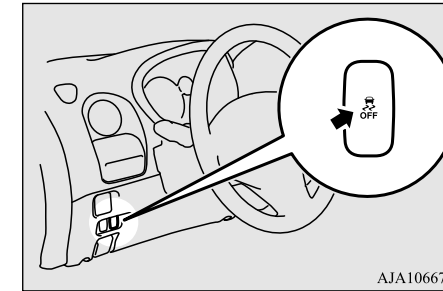

5

NOTE

- An operation noise may be emitted from under the hood in the following situations. The sound is associated with checking the operations of the ASC. At this time, you may feel a shock from the brake pedal if you depress it. These do not indicate a malfunction.
- When the electric motor switch is set to the “ON” position.
- When the vehicle is driven for a while after the electric motor unit is turned on.
- When the ASC is activated, you may feel a vibration in the vehicle body or hear a whining sound from under the hood. This indicates that the system is operating normally. It does not indicate a malfunction.
- When the anti-lock braking system warning light is illuminated, the ASC is not active.

CAUTION

- When driving a vehicle on a snowy or icy road, be sure to install snow tires and drive the vehicle at moderate speeds.

Skid control function

N00546800049

The skid control function is designed to help the driver maintain control of the vehicle on slippery roads or during rapid steering maneuvers. It works by controlling the electric motor unit output and the brake on each wheel.

NOTE

- The skid control function operates at speeds of about 9 mph (15 km/h) or higher.

Traction control function

N00559200089

On slippery surfaces, the traction control function prevents the drive wheels from spinning excessively, thus helping the vehicle to start moving from a stopped condition. It also provides sufficient driving force and steering performance as the vehicle turns while pressing the acceleration pedal.

ASC OFF switch

N00559401280

The ASC is automatically activated when the electric motor switch is turned to the “ON” position. You can deactivate the system by pressing down the ASC OFF switch for 3 seconds or longer.

When the ASC is deactivated, the  indicator will be illuminated. To reactivate the

CAUTION

- For safety reasons, the ASC OFF switch should be operated when your vehicle is stopped.
- Be sure to keep the ASC on while driving in normal circumstances.
- If you deactivate the ASC to move out of mud, sand or fresh snow, be sure to reactivate the ASC immediately when done. Do not deactivate the ASC except when necessary.
- If you depress the accelerator pedal excessively and the wheels continue spinning while the ASC is deactivated, the transmission or other parts may become damaged and could cause an accident.

Tire pressure monitoring system

NOTE

- Using the ASC OFF switch turns off both the skid control function and the traction control function.
- When trying to move out of mud, sand or fresh snow, even if the accelerator pedal is depressed, the ASC may not allow the electric motor speed to increase enough to move the vehicle out.
In such situations, deactivating the ASC may make it easier to move your vehicle out. Refer to “If your vehicle becomes stuck in sand, mud or snow” on page 8-13.
- If you continue to press the ASC OFF switch after the ASC has been turned off, the ASC will automatically be reactivated to prevent misoperation of the ASC OFF switch.

5

ASC indicator, ASC OFF indicator

N00546901063





The indicators should illuminate when the electric motor switch is turned to the “ON” position, and should turn off after a few seconds.



If the indicator stays on or does not illuminate when the electric motor switch is turned to the “ON” position, have the vehicle inspected by a certified i-MiEV dealer as soon as possible.

 indicator blinks when the ASC is operating.

 indicator is illuminated when the ASC is deactivated.

CAUTION

- When  indicator blinks, the ASC is operating, which means that the road is slippery or that your vehicle’s wheels are beginning to slip. If this happens, drive slower.
- If an abnormal condition occurs in the system while driving, the  and  indicators will illuminate.
In these cases, follow these procedures:
 - Park your vehicle in a safe place and stop the electric motor unit. Restart the electric motor unit again and check whether the  and  indicators go out. If these indicators go out, there is no abnormal condition.

If the  and  indicators remain on even after your vehicle is driven a short distance after re-starting the electric motor unit, have the vehicle inspected by a certified i-MiEV dealer as soon as possible.

- When towing the vehicle with only the rear wheels raised off the ground, do not place the electric motor switch in the “ON” position. Placing the electric motor switch in the “ON” position could cause the ASC to operate, resulting in an accident.
For details, refer to “Towing” on page 8-11.

Tire pressure monitoring system

N00530201537

The tire pressure monitoring system uses tire inflation pressure sensors (A) on the wheels to monitor the tire inflation pressures. The system only indicates when a tire is significantly under-inflated.

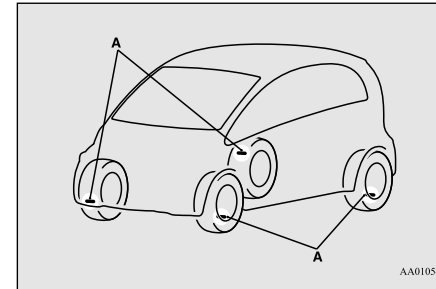

NOTE

- The tire pressure monitoring system is not a substitute for regularly checking tire inflation pressures.
Be sure to check the tire inflation pressures as described in “Tires” on page 9-10.

Tire pressure monitoring system

NOTE

- The tire inflation pressure sensor (A) is installed in the illustrated location. Replace grommet (B) with a new one when the tire is replaced.
For details, please contact a certified i-MiEV dealer.

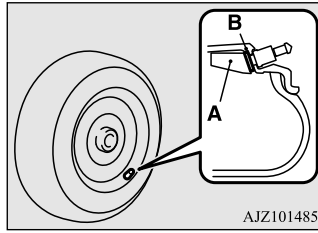
**Tire pressure monitoring system warning light**

N00554800136

When the electric motor switch is turned to the “ON” position, this light normally illuminates and goes off a few seconds later. If one or more of the vehicle tires is significantly under-inflated, however, this light will remain illuminated while the electric motor switch is in the “ON” position. Refer to “If the warning light illuminates while driving” on page 5-32 and take the necessary measures.

CAUTION

- If the tire pressure monitoring system warning light does not illuminate when the electric motor switch is turned to the “ON” position, it means that the tire pressure monitoring system is not working properly. Have the system inspected by a certified i-MiEV dealer.
In such situations, a malfunctioning of the system may be preventing the monitoring of the tire pressure. Avoid sudden braking, sharp turning and high-speed driving.
- If a malfunction is detected in the tire pressure monitoring system, the tire pressure monitoring system warning light will blink for approximately 1 minute and then remain continuously illuminated. The warning light will issue further warnings each time the electric motor unit is restarted as long as the malfunction exists.
Check to see whether the warning light goes off after few minutes of driving.
If it then goes off during driving, there is no problem.
However, if the warning light does not go off, or if it blinks again when the electric motor unit is restarted, have the vehicle inspected by a certified i-MiEV dealer.
In such situations, a malfunctioning of the system may be preventing the monitoring of the tire pressure. For safety reasons, when the warning light appears while driving, avoid sudden braking, sharp turning and high-speed driving.

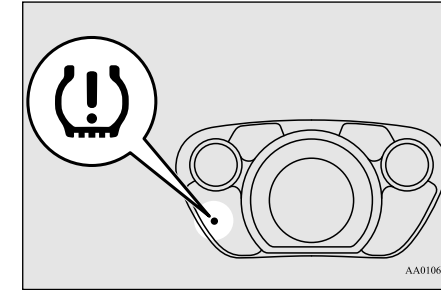
**5**

Each tire, including the spare (if provided), should be checked monthly when cold and inflated to the inflation pressure recommended by the vehicle manufacturer on the vehicle placard or tire inflation pressure label. (If your vehicle has tires of a different size than the size indicated on the vehicle placard or tire inflation pressure label, you should determine the proper tire inflation pressure for those tires.)

As an added safety feature, your vehicle has been equipped with a tire pressure monitoring system (TPMS) that illuminates a low tire pressure telltale when one or more of your tires is significantly under-inflated. Accordingly, when the low tire pressure telltale illuminates, you should stop and check your tires as soon as possible, and inflate them to the proper pressure.

Tire pressure monitoring system

Driving on a significantly under-inflated tire causes the tire to overheat and can lead to tire failure.

Under-inflation also reduces alternative fuel efficiency and tire tread life, and may affect the vehicle's handling and stopping ability.

5

Please note that the TPMS is not a substitute for proper tire maintenance, and it is the driver's responsibility to maintain correct tire pressure, even if under-inflation has not reached the level to trigger illumination of the TPMS low tire pressure telltale.

Your vehicle has also been equipped with a TPMS malfunction indicator to indicate when the system is not operating properly. The TPMS malfunction indicator is combined with the low tire pressure telltale.

When the system detects a malfunction, the telltale will flash for approximately one minute and then remain continuously illuminated. This sequence will continue upon subsequent vehicle start-ups as long as the malfunction exists.

When the malfunction indicator is illuminated, the system may not be able to detect or signal low tire pressure as intended.

TPMS malfunctions may occur for a variety of reasons, including the installation of replacement or alternate tires or wheels on the vehicle that prevent the TPMS from functioning properly. Always check the TPMS malfunction telltale after replacing one or more

5-32 Features and controls

tires or wheels on your vehicle to ensure that the replacement or alternate tires and wheels allow the TPMS to continue to function properly.

If the warning light illuminates while driving

N00532800484

1. If the low tire pressure monitoring system warning light illuminates, avoid hard braking, sharp steering maneuvers and high speeds. You should stop and adjust the tires to the proper inflation pressure as soon as possible. Refer to "Tires" on page 9-10.

NOTE

- When inspecting or adjusting the tire pressure, to avoid breakage, do not apply excessive force to the valve stem.
- After inspecting or adjusting the tire pressure, always reinstall the valve cap on the valve stem.
Without the valve cap, dirt or moisture could get into the valve, resulting in damage to the tire inflation pressure sensor.
- Do not use metal valve caps, which may cause a metal reaction, resulting in corrosion and damage of the tire inflation pressure sensors.
- Once adjustments have been made, the warning light will go off after a few minutes of driving.

2. If the tire pressure monitoring system warning light remains illuminated after you have been driving for about 20 minutes after you adjust the tire inflation pressure, one or more of the tires may have a puncture. Inspect the tire and if it has a puncture, have it repaired by a certified i-MiEV dealer as soon as possible.

WARNING

- If the tire pressure monitoring system warning light illuminates while you are driving, avoid hard braking, sharp steering maneuvers and high speeds. Driving with an under-inflated tire adversely affects vehicle performance and can result in an accident.

CAUTION

- The tire pressure monitoring system warning light may not illuminate immediately in the event of a tire blowout or rapid leak.

NOTE

- To avoid the risk of damage to the tire inflation pressure sensors, have any punctured tire repaired by a certified i-MiEV dealer. If the tire repair is not done by a certified i-MiEV dealer, it is not covered by your warranty.

Tire pressure monitoring system

 **NOTE**

- Do not use an aerosol puncture-repair spray on any tire. Such a spray could damage the tire inflation pressure sensors.
- Using the tire repair kit may damage the tire inflation pressure sensor. The vehicle must promptly be inspected and repaired by a certified i-MiEV dealer after using the tire repair kit.

The tire pressure monitoring system may not work normally in the following circumstances:

- A wireless facility or device using the same frequency is near the vehicle.
- Snow or ice is stuck inside the fenders and/or on the wheels.
- The tire inflation pressure sensors' battery is exhausted.
- Wheels other than Mitsubishi Motors genuine wheels are being used.
- Wheels that are not fitted with tire inflation pressure sensors are being used.
- Wheels whose ID codes are not memorized by the vehicle are used.
- A window tint that affects the radio wave signals is installed.

 **NOTE**

- Tire inflation pressures vary with the ambient temperature. If the vehicle is subjected to large variations in ambient temperature, the tire inflation pressures may be under-inflated (causing the warning light to come on) when the ambient temperature is relatively low. If the warning light comes on, adjust the tire inflation pressure.

Whenever the tires and wheels are replaced with new ones

N00532900182

If you use new wheels with new tire inflation pressure sensors, their ID codes must be programmed into the tire pressure monitoring system. Have tire and wheel replacement performed by a certified i-MiEV dealer to avoid the risk of damaging the tire inflation pressure sensors.

 **CAUTION**

- The use of non-genuine wheels will prevent the proper fit of the tire inflation pressure sensors, resulting air leakage or damage of the sensors.

General information

N00533000207

Your tire pressure monitoring system operates on a radio frequency subject to Federal Communications Commission (FCC) Rules (For vehicles sold in U.S.A.) and Industry Canada Rules (For vehicles sold in Canada). This device complies with Part 15 of the FCC Rules and RSS- Gen of the Industry Canada Rules.

Operation is subject to the following two conditions.

- This device may not cause harmful interference.
- This device must accept any interference received, including interference that may cause undesired operation.

 **CAUTION**

- Changes or modifications not expressly approved by the manufacturer for compliance could void the user's authority to operate the equipment.

5

Rear-view camera (if so equipped)

Rear-view camera (if so equipped)

N00546201200

When the selector lever is in the “R” (REVERSE) position with the electric motor switch is in the “ON” position, the rear-view image will be displayed on the screen of the Mitsubishi Multi Communication System.

When the selector lever is shifted out of the “R” position, the rear-view image will turn off.

5

⚠ WARNING

- Never rely solely on the rear-view camera to clear the area behind your vehicle. Always check visually behind and all around your vehicle for persons, animals, obstructions or other vehicles. Failure to do so can result in vehicle damage, serious injury or death.
- The rear-view camera is an aid system for backing up, but it is not a substitute for your visual confirmation.
- The view on the screen is limited, and objects outside the view, such as under the bumper or around either corner of the bumper end, cannot be seen on the screen.

Location of rear-view camera

The rear-view camera is in the liftgate.

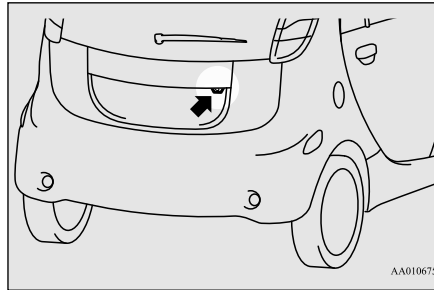

⚠ CAUTION

- If the camera lens gets dirty, a clear image cannot be obtained. As necessary, rinse the lens with clean water and gently wipe with a clean, soft cloth.
- To avoid damaging the camera;
 - Do not rub the cover excessively or polish it by using an abrasive compound.
 - Do not disassemble the camera.
 - Do not splash hot water directly on the lens.
 - Do not spray the camera and its surroundings with high-pressure water.
- Make sure that the liftgate is securely closed when backing up.

Reference lines on the screen

Reference lines and upper surface of the rear bumper (A) are displayed on the screen.

- Red line (B) indicates approximately 20 inches (50 cm) behind the rear bumper.
- Two Green lines (C) indicate approximately 8 inches (20 cm) outside of the vehicle body.
- Short transverse lines (1 to 3) indicate distance from the rear bumper.

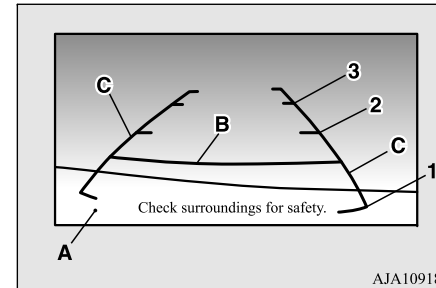

- 1: Approximately at the rear edge of the rear bumper
- 2: Approximately 39 inches (100 cm)
- 3: Approximately 79 inches (200 cm)

Rear-view camera (if so equipped)

CAUTION

- The rear-view camera uses a wide-angle lens. As a result, images and distances shown on the screen are not exact.
- Actual distance may be different from distance indicated by the lines on the screen, depending on the loading condition of the vehicle and road surface condition. The reference lines for distance and vehicle width are based on a level, flat road surface. In the following cases, objects shown on the screen will appear to be farther off than they actually are.
 - When the rear of the vehicle is weighed down with the weight of passengers and luggage in the vehicle. (Case 1)
 - When there is an upward slope at the back. (Case2)

Case 1

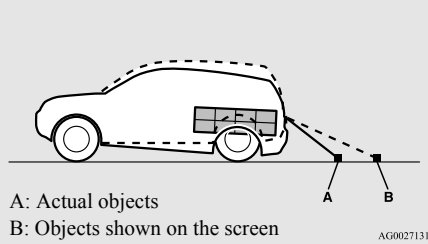

Case 2

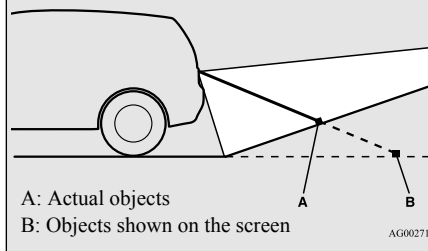

CAUTION

- The reference lines for distance and vehicle width are intended to indicate the distance to a flat object such as a level, flat road surface. They may not indicate correct distance depending on the shape of an obstacle. For example, when there is an object behind the vehicle that has upper sections projecting in the direction of the vehicle, the reference lines on the screen will indicate that point A is the farthest point and point B is the closest point to the vehicle. In reality, point A and B are actually the same distance from the vehicle, and point C is farther off than point A and B.

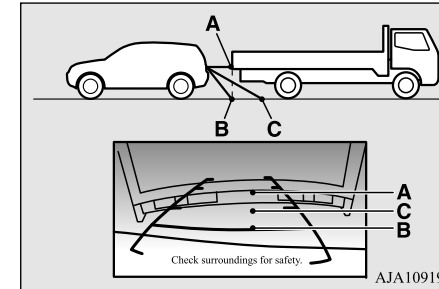

NOTE

- Mirror image is displayed on the screen.
- Monitor brightness is adjusted automatically by sensors.
- It is possible to change the display language of the screen. For details, please refer to the separate owner's manual for "Mitsubishi Multi-Communication System".
- Under certain circumstances, it may become difficult to see an image on the screen, even when the system is functioning correctly.
 - In a dark area, such as at night.
 - When water drops or condensation are on the lens.
 - When sunlight or headlights shine directly into the lens.

Instrument cluster

Instrument cluster

N00519000375

5

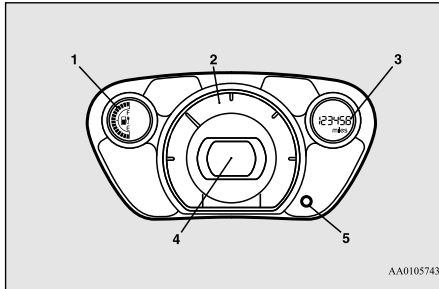

- 1- Energy level gauge
- 2- Energy usage indicator
- 3- Odometer/Trip odometer/Dash lights brightness indicator/Service reminder/Cruising range indicator/Outside temperature display
- 4- Speedometer
- 5- Reset button/Dash lights illumination button/Selector button

Speedometer

N00519100246

When the electric motor switch is in the “ON” position, the speedometer indicates the vehicle’s speed in miles per hour (mph) or kilometers per hour (km/h).

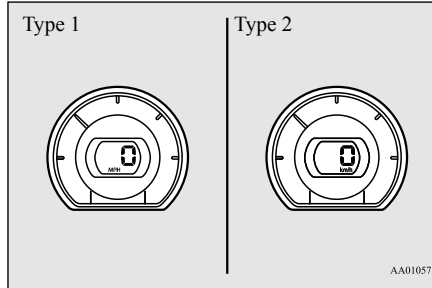

NOTE

- The display setting can be changed to the preferred units (miles or km). Refer to “Changing the display unit” on page 5-36.

Changing the display unit

N00572000013

It is possible to select the speedometer’s display unit.

1. Press the reset button (A) to display the odometer (B). (Refer to “To change the display” on page 5-37.)
2. Keep the reset button pressed for 2 seconds or longer to change the display unit from MPH to km/h or from km/h to MPH.

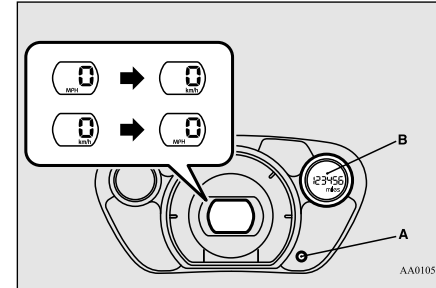

NOTE

- Once the display unit has changed, keeping the reset button pressed will not cause the display unit to change again.

The display unit for the cruising range will change to match the selected speedometer’s display unit.

Speedometer	Cruising range
MPH	miles
km/h	km

NOTE

- Even if speedometer’s display unit is changed, the display units for the odometer, trip odometer, and service reminder do not change.

Instrument cluster

Energy usage indicator

N00572101037

The power consumption of the electric motor, the air conditioning, and power generation by the regenerative brake are indicated.

When the ready indicator comes on, the red needle will move to the neutral point (A) and then move to the right or left according to the amount of power consumption or power generation.

[When the red needle moves to the right of the neutral point]

This indicates that the electric motor unit and/or the air conditioning are consuming electric energy from the main drive lithium-ion battery.

The more the needle moves to the right, the more electrical energy is being consumed.

[When the red needle moves to the left of the neutral point]

This indicates that electric energy is being generated by the regenerative brake and charged to the main drive lithium-ion battery. The more the needle moves to the left, the more electric energy is being generated.

NOTE

- When the main drive lithium-ion battery is at or near full charge, or the main drive lithium-ion battery temperature is too high or too low, the needle in the energy usage indicator may not move to the left of the neutral point, since the main drive lithium-ion battery cannot receive charge.

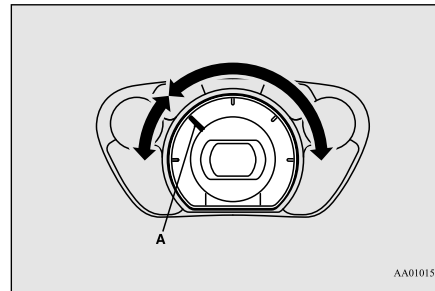

AA0101572

Odometer/Trip odometer/Dash lights brightness indicator/Service reminder/Cruising range indicator/Outside temperature display

N00519501449

Odometer, trip odometer, dash lights brightness indicator, service reminder, cruising

range indicator, and outside temperature are displayed.

To change the display

N00572201025

The display is changed every time the reset button (A) is briefly pressed.

5

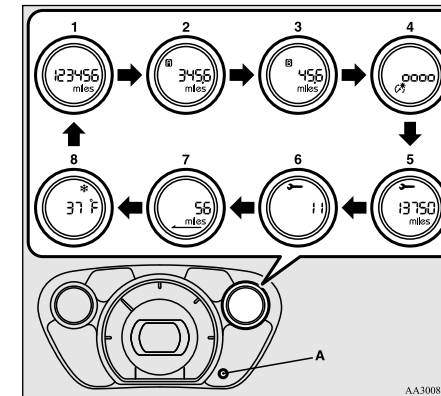

AA3008148

- 1- Odometer
- 2- Trip odometer **A**
- 3- Trip odometer **B**
- 4- Dash lights brightness indicator
- 5- Service reminder (Drive distance remaining until next inspection)
- 6- Service reminder (Number of months remaining until next inspection)
- 7- Cruising range indicator

Instrument cluster

8- Outside temperature display

NOTE

- The cruising range indicator and outside temperature display are not indicated when the electric motor switch is in the “ACC” or “LOCK” position.
- If there is no operation for about 10 seconds when the meter illumination control or service reminder is shown, the display returns to the odometer.

5

Odometer

N00572300016

The odometer indicates the total distance the vehicle has traveled.

NOTE

- Even if the electric motor switch is turned to “ACC” or “LOCK”, the odometer will be displayed for about 30 seconds after the reset button is pressed.

Trip odometer

N00572400020

The trip odometer shows the distance traveled since the last time it was reset.

There are two trip odometer displays: **A** and **B**.

Trip odometer **A** can be used to measure the distance traveled since the current trip began.

At the same time, Trip odometer **B** can be used to measure the distance from a second location.

NOTE

- Even if the electric motor switch is turned to “ACC” or “LOCK” position, the trip odometer will be displayed for about 30 seconds after the reset button is pressed.

To reset the trip odometer

To zero the counter, press and hold the reset button for more than 1 second. Only the currently displayed value will be reset.

If trip odometer **A** is displayed, for example, only trip odometer **A** will be reset.

NOTE

- Both trip odometer **A** and trip odometer **B** can measure trips up to 9999.9 miles/kilometers.
- If the 12V starter battery is disconnected for a long time, both of these displays will be reset to “0”.

Service reminder

N00572500021

The service reminder shows the driving distance or number of months remaining until the next recommended periodic maintenance inspection is required.

When the next inspection is nearly due, the display shows “-----”.

NOTE

- The service reminder time can be modified by a certified i-MiEV dealer, to adjust for severe usage, etc. Refer to “Severe maintenance schedule” in your vehicle’s Warranty and Maintenance Manual. For further information, please contact a certified i-MiEV dealer.
- Even if the electric motor switch is turned to “ACC” or “LOCK” position, the service reminder will be displayed for about 30 seconds after reset button is pressed.

Driving distance

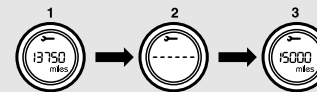

Number of months

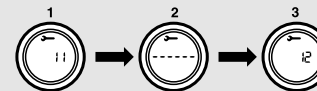

AA0105785

1. The display shows the driving distance or number of months remaining until the next periodic inspection.
2. This informs you that a periodic inspection is due. Contact a certified i-MiEV dealer to have the system checked.

At this time, a spanner mark is shown for a few seconds whenever the electric motor switch is turned from the “LOCK” position or the “ACC” position to the “ON” position.

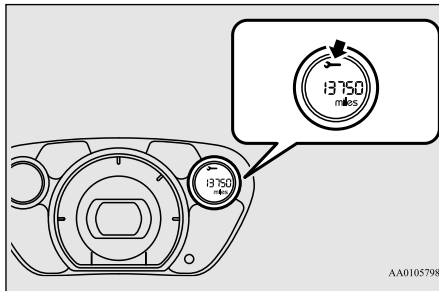

3. After your vehicle is inspected at a certified i-MiEV dealer, it displays the time and miles (km) until the next periodic inspection.

NOTE

- The indicated distance decreases in steps of 100miles (100 km). The indicated number of months decreases in steps of one month.

NOTE

- It is possible to change the settings for the service reminder.
For further information, we recommend you to consult a certified i-MiEV dealer.

Resetting the service reminder

With the electric motor switch in the “LOCK” position or the “ACC” position, it is possible to reset the spanner mark (A) and “----” indication (B).

When they have been reset, the driving distance or number of months remaining until the next periodic inspection are shown and the spanner mark (A) is no longer shown every time the electric motor switch is turned from the “LOCK” position or the “ACC” position to the “ON” position.

Instrument cluster

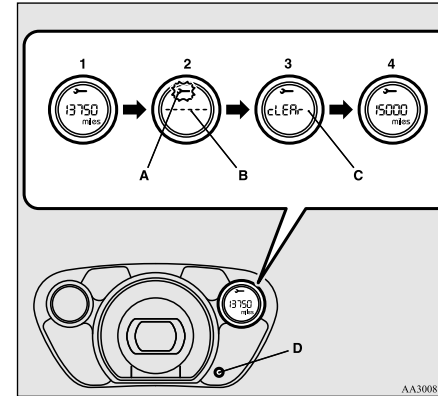

5

1. Push the reset button (D) to view the driving distance or number of months remaining until the next periodic inspection.
2. Give the reset button (D) a long push (at least 2 seconds) to make the spanner mark (A) start flashing. (If you do not touch the reset button for about 10 seconds while the spanner mark is flashing, the display will revert to its original indication.)
3. Give the reset button (D) a gentle push while the spanner mark is flashing. The “----” indication (B) will change to “cLEAR” (C).
4. The driving distance or number of months remaining until the next periodic inspection will be shown.

Instrument cluster

5

CAUTION

- The customer is responsible for making sure that regular inspections and maintenance are performed. Inspections and maintenance must be performed to prevent accidents and malfunctions.

NOTE

- It is not possible to reset the “-----” indication (B) with the electric motor switch in the “ON” position.
- When a certain distance has been driven and a certain period has elapsed after appearance of the “-----” indication (B), the indication is automatically reset and the number of months until the next periodic inspection is shown.
- If you accidentally reset the display, consult a certified i-MiEV dealer for assistance.

Dash lights brightness indicator

N00572600019

Each time you press the dash lights illumination button (B), the brightness of the instruments changes.

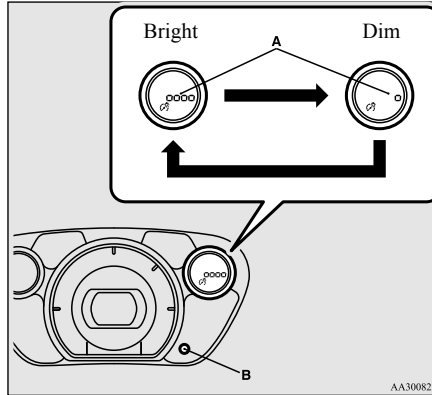

- A- Brightness display
- B- Dash lights illumination button

NOTE

- You can adjust to 4 different levels for when the parking lights or headlights are illuminated and 4 for when they are not.
- If you press and hold the button for longer than about 1 second, the brightness automatically scrolls through its different levels, and stops scrolling when you release the button. Select your desired level of brightness.
- When the combination headlights and dimmer switch is in the “AUTO” position, the meter illumination switches automatically to the adjusted brightness, depending on the brightness outside the vehicle.

NOTE

- The brightness level of the instruments is stored when the electric motor switch is turned off.
- If the 12V starter battery is disconnected for a long time, these level of brightness will be reset.

Cruising range indicator

N00572700036

This displays the approximate cruising range (how many more miles or kilometres you can drive). When the cruising range becomes short, the indication changes to “---”.

NOTE

- The cruising range is displayed based on the past drive data. It may vary depending on the driving condition (road condition, driving situation, etc.) and air conditioning operation status. For example, the cruising range can be shortened by driving on congested roads, by driving uphill, by repeated hard acceleration, and by use of the air conditioner and heater. When the 12V starter battery terminal is disconnected, the power consumption data of the main drive lithium-ion battery in the past is deleted. A different value from before may be displayed. Be sure to use the display only for reference.

NOTE

- When the main drive lithium-ion battery is charged, the approximate cruising range is updated.

Outside temperature display

N00573000010

This value (A) shows the outside temperature of the vehicle.

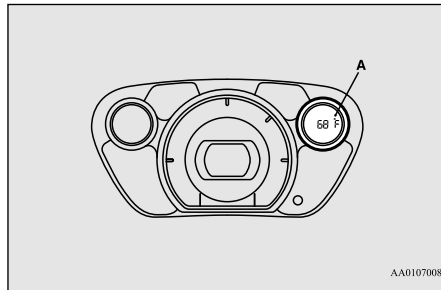

NOTE

- The outside temperature can be displayed from -40 °F (-40 °C) to 122 °F (50 °C).
- When the outside temperature is over 122 °F (50 °C) or below -40 °F (-40 °C), the display will remain 122 °F (50 °C) or -40 °F (-40 °C).

NOTE

- The outside temperature displayed may differ from the actual temperature on account of surrounding conditions, driving conditions, etc.

If the outside temperature drops below approximately 37 °F (3 °C), the alarm sounds and the outside air temperature warning indicator (B) flash for approximately 10 seconds to show there is a danger the road might be icy.

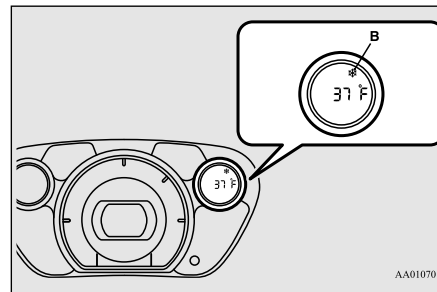

CAUTION

- Even when the outside air temperature warning indicator (B) indications do not flash, the road may be icy, so please take care when driving.

Change of the outside temperature unit

N00573100011

When the electric motor switch is in the “ACC” or “ON” position, pressing the selector button (A) for more than 2 seconds will switch the outside temperature unit between °F and °C.

5

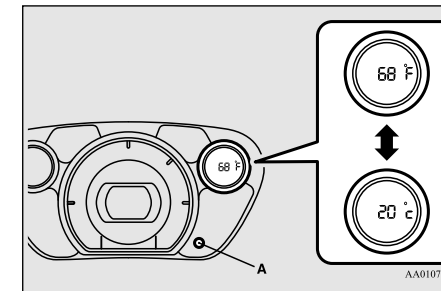

NOTE

- Disconnecting the battery cable causes the outside temperature unit memory to be erased. If it has been disconnected, readjust the unit with the above procedure.

Energy level gauge

N00572800024

The energy level gauge indicates the remaining power in the main drive lithium-ion bat-

Instrument cluster

tery during charging or when the electric motor switch is in the “ON” position.

5

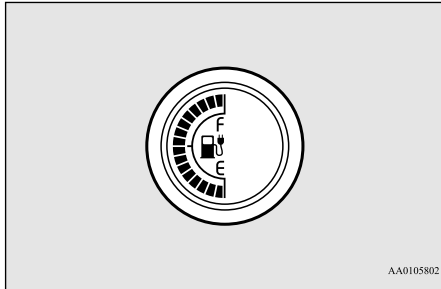

F- Battery is fully charged.
E- Charge the battery.

NOTE
● The charging indicator is also illuminated during charging.
Refer to “Charging indicator” on page 5-44.

Low energy warning indicator

N00572900025

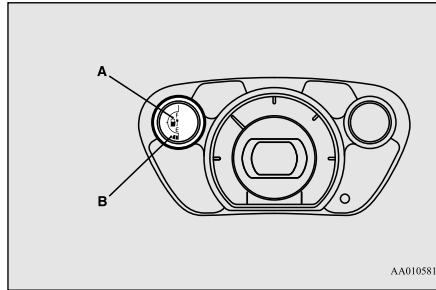

When the electric motor switch is in the “ON” position and the remaining bar of the energy level gauge shows 2 bars or less, the warning indicator (A) and the charging bars (B) flash as follows:

When the energy level gauge shows 2 bars:
The warning indicator flashes.

When the energy level gauge shows 1 bar:
The warning indicator and the charging bars flash alternately.

Recharge the main drive lithium-ion battery as soon as possible.

NOTE

- If the energy level gauge shows 0 bars during use of the air conditioning, the cooling or heating may stop operation and the mode is changed to fan only.
- If the energy level gauge shows 0 bars, the power down warning light is illuminated to control the output.
- If the energy level gauge shows 2 bars while the main drive lithium-ion battery is being charged, the warning indicator flashes. If the energy level gauge shows 1 bar while the main drive lithium-ion battery is being charged, the warning indicator and the charging bars flash alternately.

Indicator and warning light package

Indicator and warning light package

N00519801888

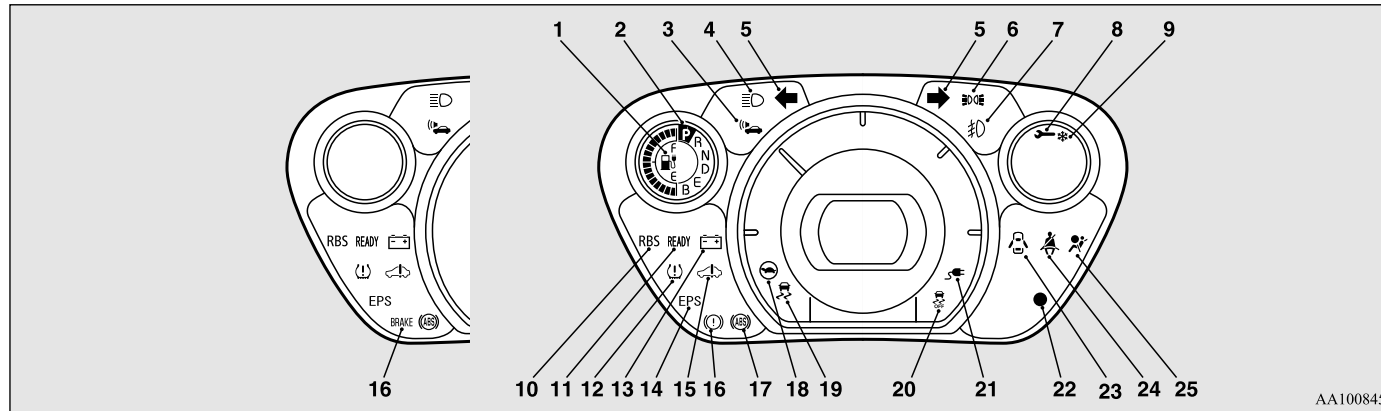

5

- | | | |
|---|--|--|
| <ul style="list-style-type: none"> 1- Low energy warning indicator → P.5-42 2- Selector lever position indicator → P.5-21 3- Acoustic Vehicle Alerting System (AVAS) indicator → P.5-23 4- High-beam indicator → P.5-44 5- Turn-signal indicators/Hazard warning lights → P.5-44 6- Position indicator → P.5-44 7- Front fog light indicator → P.5-44 8- Service reminder → P.5-38 9- Outside air temperature warning indicator → P.5-41 | <ul style="list-style-type: none"> 10- Regenerative brake system indicator → P.5-44 11- Ready indicator → P.5-44 12- Tire pressure monitoring system warning light → P.5-31 13- 12V starter battery charging system warning light → P.5-45 14- Electric power steering system warning light → P.5-28 15- Electric motor unit warning light → P.5-45 16- Brake warning light → P.5-44 17- Anti-lock braking system warning light → P.5-26 | <ul style="list-style-type: none"> 18- Power down warning light → P.5-46 19- Active stability control (ASC) indicator → P.5-30 20- Active stability control (ASC) OFF indicator → P.5-30 21- Charging indicator → P.5-44 22- Theft-alarm indicator → P.5-12 23- Door-ajar warning light → P.5-45 24- Driver's seat belt reminder/warning light → P.4-10 25- Supplemental Restraint System (SRS) warning light → P.4-13 |
|---|--|--|

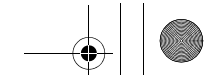

Indicators

Indicators

N00519900127

Turn signal indicators/Hazard warning lights

N00520000232

5

The arrows will flash in time with the corresponding exterior turn signals when the turn signal lever is used.

Both arrows will flash when the hazard warning flasher switch is pressed.

NOTE

- If the indicator flashes faster than usual or if the indicator stays on without flashing, check for a malfunctioning turn signal light bulb or turn signal connection.

High beam indicator

N00520100086

A blue light comes on when the headlights are on high beam.

Front fog light indicator

N00520201244

This indicator comes on while the front fog lights are on.

Position indicator

N00551300039

This indicator turns on while the position lights are on.

Ready indicator

N00573200012

This indicator comes on when the electric motor switch is turned to “START” and driving becomes possible.

Charging indicator

N00573301023

This indicator flashes when the EV charging cable (regular charger or quick charger) is connected.

After that, the light switches to being illuminated when charging starts and goes out when charging is completed.

NOTE

- Although it is possible to start the electric motor unit if quick charging has not finished normally, the charging indicator is continuously blinking. Refer to “Charging troubleshooting guide” on page 3-31.

Regenerative brake system indicator

N00573400014

The indicator comes on when the regenerative brake performance may be weakened. In this case, drive the vehicle at a lower speed.

Warning lights

N00520300147

Brake warning light

N00520400513

This light comes on when the electric motor switch is turned to the “ON” position, and goes off after a few seconds when the parking brake is released. Before driving your vehicle, release the parking brake and make certain that the brake warning light has gone off. If the light stays on when the parking brake is fully released, the service brake system is not working properly or the brake fluid level is low.

WARNING

- If any of the following conditions occur, the brake effort may significantly increase. Stop the vehicle in a safe location, avoiding where possible any sudden brake application, and contact a certified i-MiEV dealer.

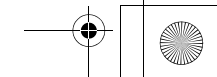
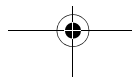

Warning lights

WARNING

- The brake warning light does not come on when the electric motor switch is turned to the “ON” position.
- The brake warning light does not illuminate while the parking brake is applied and the electric motor switch is in the “ON” position.
- The brake warning light stays on when the parking brake is not applied.

NOTE

- When the brake warning light illuminates, the warning buzzer may also sound.
- When the brake pedal has been repeatedly depressed over a short period of time, the brake warning light may come on and the brake warning buzzer may sound. The service brake system is working normally, if the warning light goes out and the buzzer stops sounding in a few seconds.

12V starter battery charging system warning light

N00573500028

This light will illuminate when there is a problem with the charging system for the 12V starter battery.

Normally, when the electric motor switch is turned to the “ON” position, this light will

illuminate. Then, when the electric motor unit is started and the ready indicator illuminates, the light will go out.

CAUTION

- If the warning light stays on after the ready indicator illuminates, there may be a problem with the charging system for the 12V starter battery.
 - Immediately park your vehicle in a safe place and contact a certified i-MiEV dealer.
 - Do not charge the 12V starter battery.

Door-ajar warning light and buzzer

N00520900316

This light comes on when any door or liftgate is open or not completely closed.

When the vehicle is moving at more than 5 mph (8 km/h) and any door or liftgate is open or ajar, a tone will sound 16 times and the warning light will flash 16 times to inform the driver that a door or liftgate is not properly shut.

CAUTION

- Before driving, make sure that the door-ajar warning light is off.

NOTE

- The flashing of the warning light and the buzzer can be disabled. For further details, please contact a certified i-MiEV dealer.
- When the driver’s door is open, the door-ajar warning buzzer does not sound because the electric motor reminder sounds instead.

5

Electric motor unit warning light

N00573600029

This warning light will illuminate when there is a problem with a high voltage component. Refer to “Service precautions” on page 9-2.

CAUTION

- If this light illuminates while driving, immediately park your vehicle in a safe place and contact a certified i-MiEV dealer.

Combination headlights and dimmer switch

Power down warning light

N00573700020

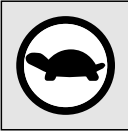

5

If this warning light illuminates, the power provided by the electric motor will be reduced and the vehicle will be only able to move at low speeds.

This warning light will illuminate;

- When the energy level in the main drive lithium-ion battery is near empty.
- When temperature of the electric motor unit or the main drive lithium-ion battery is too high or too low.
- When voltage of the main drive lithium-ion battery becomes low.

If the energy level gauge shows 0 bar, the main drive lithium-ion battery is near empty and must be charged as soon as possible. Refer to “Charging” on page 3-13.

If the warning light illuminates when the outside air temperature is very low, move the vehicle to a warmer location.

If the warning light illuminates after the vehicle has been driven continuously uphill or when the outside air temperature is very high, stop the vehicle in a safe place so the electric motor unit and/or the main drive lithium-ion battery can cool down. When they have cooled down, the warning light will go off. If the warning light does not turn off, contact a certified i-MiEV dealer.

NOTE

- When the power down warning light illuminates, avoid rapid starts and aggressive acceleration.
- Illumination of the power down warning light does not indicate a malfunction.
- If the power down warning light illuminates while the air conditioning is used, the cooling or heating may stop operating and only the fan will operate.

Combination headlights and dimmer switch

N00522501805

Headlights

NOTE

- Do not leave the headlights and other lights on for a long period of time while the ready indicator is not illuminated. A run down 12V starter battery could result.
- When it rains, or when the vehicle has been washed, the inside of the lens sometimes becomes foggy. This is the same as when window glass mists up on a humid day, and does not indicate a problem. When the light is switched on, the heat will dry out the fog. However, if water collects inside the light, have it checked by a certified i-MiEV dealer.

Rotate the switch to operate the lights.

Combination headlights and dimmer switch

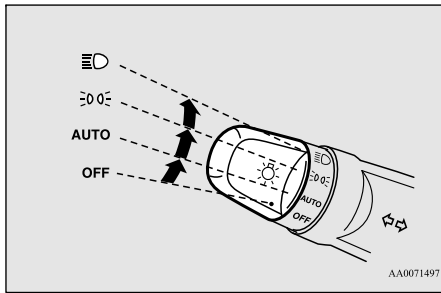

The combinations of switch operations and illuminated lights differ in accordance with the following conditions.

[When the ready indicator is illuminated, and the parking brake is released]

The daytime running lights will be illuminated:

OFF	The daytime running lights illuminated
AUTO	The daytime running lights illuminated Headlights and other lights turn on and off automatically in accordance with outside light level.

☹☹☹	The daytime running lights illuminated Parking, tail, front and rear side-marker lights, license plate and instrument panel lights on
☹☹	Headlights and other lights on

NOTE	
<ul style="list-style-type: none"> Once the daytime running light come on, they do not go out until the electric motor switch is turned to the "LOCK" or "ACC" position. 	

[When the ready indicator is not illuminated, or when the ready indicator is illuminated but the parking brake is not released]

The electric motor unit starts when the lights are off.

OFF	All lights off
AUTO	Headlights and other lights turn on and off automatically in accordance with outside light level.
☹☹☹	Parking, tail, front and rear side-marker lights, license plate and instrument panel lights on
☹☹	Headlights and other lights on

NOTE	
<ul style="list-style-type: none"> The sensitivity of the automatic on/off control can be adjusted. For further information, please contact a certified i-MiEV dealer. Do not place anything on the sensor (A), and do not clean with a glass cleaner. Clean only with clear water. 	
<ul style="list-style-type: none"> If the lights do not turn on or off with the switch in the "AUTO" position, manually operate the switch. Have the system checked by a certified i-MiEV dealer. 	

5

Light auto-cutout function (headlights and other lights)

N00532600554

- If the key is turned to "LOCK" or "ACC" position or removed from the electric motor switch and the driver's door is opened with the combination headlights and dimmer switch in the "☹☹☹" or "☹☹" position, the lights automatically turn off.

Combination headlights and dimmer switch

5

- If the driver's door is opened after the key is removed from the electric motor switch, a buzzer will sound to remind you to turn off the lights.
- If the driver's door is opened with the key in the electric motor switch, a buzzer will sound intermittently to remind you to remove the key.
- If the key is turned to "LOCK" or "ACC" position with the driver's door closed and the combination headlights and dimmer switch in the "☰☑" or "☷☑" position, the lights will stay on for about 3 minutes and then turn off automatically.

NOTE

- The light auto-cutout function can be deactivated. See a certified i-MiEV dealer for details.

When you want to keep the lights on:

If the combination headlights and dimmer switch is turned to the "☰☑" or "☷☑" position again after the electric motor switch is turned to "LOCK" or "ACC" position, the auto-cutout function described above will not work. The lights (the parking lights, tail lights

and license plate lights) will stay on and will not turn off automatically.

NOTE

- If the driver's door is opened and the key is removed, the headlight reminder buzzer will sound. If the key is still in the electric motor switch the key reminder buzzer will sound intermittently. The buzzer stops when the driver's door is closed.

Headlight reminder buzzer

N00549800213

If the driver's door is opened with the key removed from the electric motor switch while the lights are on, the buzzer will sound to remind you to turn off the lights.

The lights and buzzer will turn off automatically.

Or you can turn the combination headlights and dimmer switch to the "OFF" position to stop the buzzer.

Dimmer (high/low beam change)

N00549900155

To change the headlights from high beam to low beam and vice versa, pull the turn signal lever to fully toward you (1). Switch the

headlights to low beam as a courtesy whenever there are oncoming vehicles, or when there is traffic moving ahead of you. An illuminated blue light in the instrument cluster indicates when the headlights are on high beam.

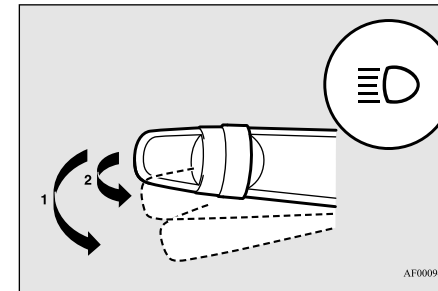

Headlight flasher

N00550000198

You can flash the high beams by pulling the lever gently toward you (2). The lights will go back to normal when you let go. While the high beam is on, you will see a blue light on the instrument panel.

NOTE

- You can flash the high beams by pulling the lever toward you, even if the combination headlights and dimmer switch is off.

Turn signal lever

NOTE

- If you turn the lights off with the headlights set to high-beam illumination, the headlights are automatically returned to their low-beam setting when the combination headlights and dimmer switch is next turned to the “” position.

Turn signal lever

N00522600506

When changing lanes, or to making a gradual turn, hold the lever in the “lane change” position (1). It will return to the neutral position when you let go. Use the full position (2) when making a normal turn. The lever will return to the neutral position when the turn is complete. There may be times when the lever does not return to the neutral position. This usually happens when the steering wheel is turned only slightly. You can easily return the lever by hand.

Also, when you move the lever to (1) slightly then release it, the turn signal lights and indicator in the instrument cluster will flash three times.

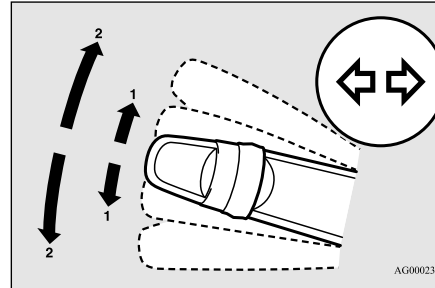

AG0002303

NOTE

- A light in the instrument panel flashes to show when the front and rear turn signal lights are working properly. If this light flashes faster than usual, check for a burned out light bulb or malfunctioning connection. If the panel light does not come on when the lever is moved, check for a blown fuse or a burned out bulb in the panel. Have the vehicle inspected by a certified i-MiEV dealer.
 - It is possible to modify functions as follows:
 - Deactivate the turn signal light 3-flash function for lane changes.
 - Adjust the time required to operate the lever for the 3-flash function.
- See a certified i-MiEV dealer for details.

Hazard warning flasher switch

N00522700305

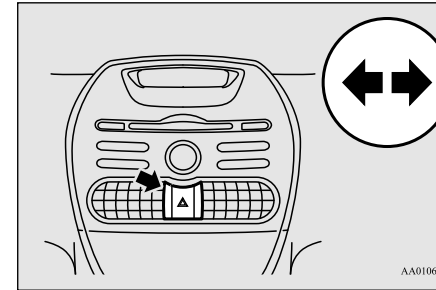

AA0106971

5

If you press the flasher switch, the front and rear turn signals will flash intermittently, and so will the hazard warning lights. This is an emergency warning system and should not be used when the vehicle is in motion, except for emergencies.

If you need to leave your vehicle, the flashers will keep working after the key is removed from the electric motor switch.

NOTE

- If you keep the flashers on for a long period of time while the ready indicator is not illuminated, the 12V starter battery could go flat and the electric motor unit could be impossible to start.

Front fog light switch

Front fog light switch

N00522801433

The front fog lights illuminate only when the headlights are on low beam.

Turning the knob in the direction of the “ON” position turns on the front fog lights as well as the indicator in the instrument cluster. To turn them off, turn the knob in the direction of the “OFF” position.

5

The knob will return to the neutral position when it is released.

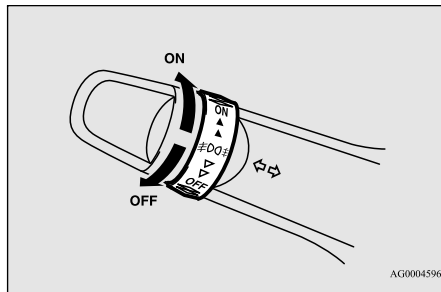

AG0004596

NOTE

- If the headlights are switched to high beam, the front fog lights will go out; they will illuminate again when the headlights are switched back to low beam.

NOTE

- If the combination headlights and dimmer switch is rotated to the “OFF” or “

Wiper and washer switch

N00523000640

CAUTION

- If the washer is used in cold weather, the washer fluid sprayed against the glass may freeze, which may hinder visibility. Warm the glass with the defroster before using the washer.

Windshield wipers

The windshield wiper and washer can be operated with the electric motor switch in the “ON” or “ACC” position.

If the blades are frozen to the windshield, do not operate the wipers until the ice has melted

and the blades are freed, otherwise the wiper motor may be damaged.

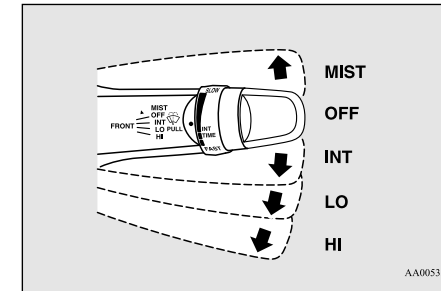

AA0053381

MIST- Misting function

The wipers will operate once.

OFF- Off

INT- Intermittent (Speed sensitive)

LO- Slow

HI- Fast

To adjust intermittent intervals

With the lever in the “INT” (speed sensitive intermittent operation) position, the intermittent intervals can be adjusted by turning the knob (A).

Wiper and washer switch

Rear window wiper and washer

N00523200394

The rear window wiper and washer can be operated when the electric motor switch in either the “ON” or “ACC” position.

Turn the knob to operate the rear window wiper.

5

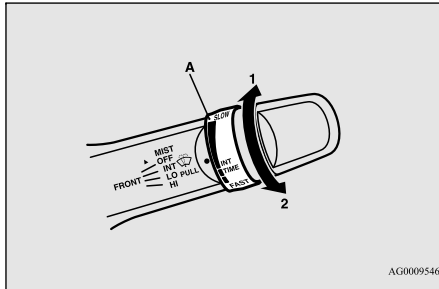

- 1- Fast
- 2- Slow

AG0009546

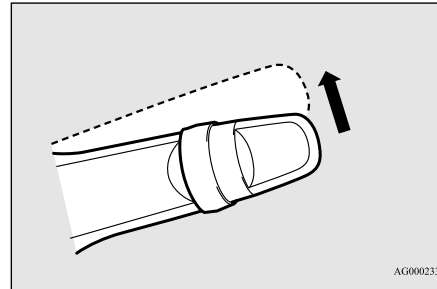

AG0002332

Windshield washer

N00504600272

To turn on the windshield washer, pull the lever toward you with the electric motor switch in either the “ON” or “ACC” position. The washer fluid will be sprayed onto the windshield by pulling the lever toward you.

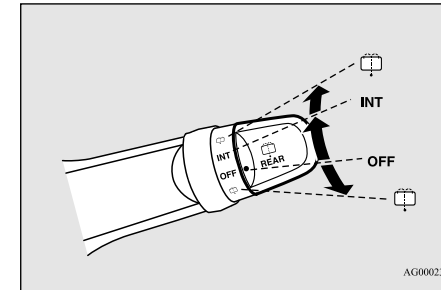

AG0002345

- OFF- Off
- INT- The wiper operates continuously for several seconds then operates intermittently at intervals of about 8 seconds.
- - Washer fluid will be sprayed onto the rear window glass while the knob is turned fully in either direction. When the washer fluid is sprayed, the wiper will automatically operate 2 or 3 times.

NOTE

- The speed-sensitive-operation function of the windshield wipers can be deactivated. For further information, please contact a certified i-MiEV dealer.

Misting function

The wipers will operate once if the wiper lever is raised to the “MIST” position and released. This operation is useful when it is drizzling, etc. The wipers will continue to operate while the lever is held in the “MIST” position.

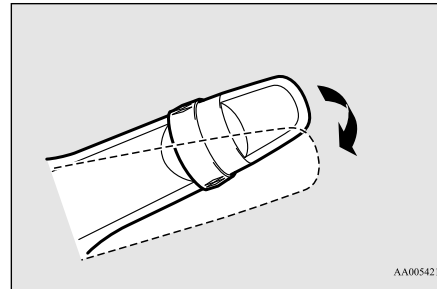

AA0054216

Electric rear window defogger switch

5

NOTE

- To ensure a clear rearward view, the wiper performs several continuous operations when the reverse gear is engaged and the switch is in the “INT” position. Following this continuous operation, the wiper will automatically switch to intermittent operation.
- It is possible to modify functions as follows:
 - Adjustment of the interval for intermittent operation
 - Changing intermittent wiper operation to continuous wiper operation
 For details, consult a certified i-MiEV dealer.
- The washer fluid reservoir is located underneath the hood. Check the fluid level regularly and refill if necessary. (Refer to “Washer fluid” on page 9-7.)

Precautions to observe when using wipers and washers

N00523500241

CAUTION

- If the washer is used in cold weather, the washer fluid sprayed onto the glass might freeze, blocking your view. In cold weather, heat the glass with the defroster before using the washer.

NOTE

- Do not use the wipers when the windshield is dry. This could scratch the glass and wear the wiper blades prematurely.
- Before using the wipers in cold weather, check to be sure that the wiper blades are not frozen to the windshield. Using the wipers while the blades are frozen could cause the wiper motor to burn out.
- If the wipers are left on the glass out of the parked position and they become blocked by ice or other deposits on the glass, the motor may still burn out even if the wiper switch is OFF. If deposits form on the windshield, park your vehicle in a safe place, turn off the electric motor switch, and clean the glass so that the wipers can operate smoothly.
- Avoid using the washer for more than 20 seconds at a time. Do not operate the washer when the fluid reservoir is empty or the pump may fail.
- During cold weather, add a recommended washer solution that will not freeze in the washer reservoir. Otherwise the washer may not work or may be damaged.
- Replace the wiper blades when they are worn. Use the proper size replacement blades. If you have questions, ask a certified i-MiEV dealer.

Electric rear window defogger switch

N00523701455

The electric rear window defogger can be used when the ready indicator is illuminated. The indicator light (A) will come on when you press the electric rear window defogger switch. Electric current will flow through the heating wires on the rear window to help clear away moisture or frost.

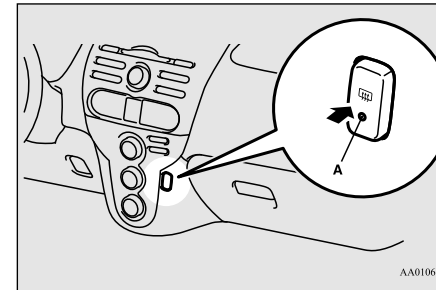

AA0106997

After about 20 minutes of operation, the system will shut off automatically. To switch the defogger OFF before 20 minutes have passed, press the switch again. The indicator light will go out and the defogger will turn off. If you need the defogger for more than 20 minutes, press the switch again. This will add 20 more minutes.

Horn switch

CAUTION

- The rear window defogger is not designed to melt snow. Remove any snow manually before using the rear window defogger.
- Use the rear window defogger only after the ready indicator is illuminated. Be sure to turn the defogger switch off immediately after the window is clear to save on 12V starter battery power.
- Do not place stickers, tape, or other items that are attached with adhesive over the grid wires on the rear window.
- When cleaning the inside rear window, use a soft cloth and wipe lightly over the grid wires.

NOTE

- If your vehicle is equipped with heated mirrors, mist can also be removed from the outside rearview mirrors when the rear window defogger switch is pressed. (Refer to “Heated mirror” on page 5-18.)
- The electric rear window defogger is activated automatically when the Remote Climate Control is activated in Pre-Defroster Mode. Refer to “Remote Climate Control” on page 3-36, 3-47 and “For persons with electro-medical apparatus such as implantable cardiac pacemaker or implantable cardiovascular defibrillator” on page 3-6.

Horn switch

N00523800172

To honk the horn, press around the “” mark on the steering wheel.

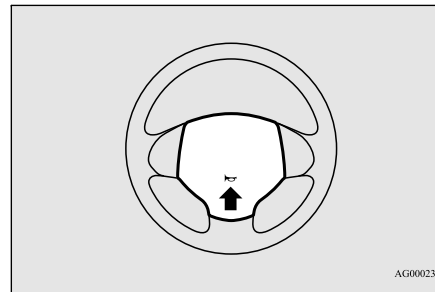

AG0002361

Link System (if so equipped)

N00563700030

The Link System takes overall control of the devices connected via the USB input terminal or the Bluetooth® 2.0 interface allowing the connected devices to be operated by using the switches in the vehicle or voice commands. See the following section for details on how to operate.

Refer to “Bluetooth® 2.0 interface” on page 5-53.

Refer to “USB input terminal” on page 5-73.

Refer to “To play iPod/USB memory device tracks via voice operation” on page 7-20.

Bluetooth® is a registered trademark of BLUETOOTH SIG, INC.

Link System End User License Agreement

N00563800015

5

You have acquired a device that includes software licensed by Mitsubishi Motors Corporation from JOHNSON CONTROLS Inc (the automotive experience business unit), and their subsequent 3rd party suppliers. For a complete list of these 3rd party products and their end user license agreements, please go to the following website.

<http://www.jciblueconnect.com/faq/fulldisclosure.pdf>

Bluetooth® 2.0 interface (if so equipped)

N00563901286

The Bluetooth® 2.0 interface allows for making/receiving hands-free calls in the vehicle using a Bluetooth® compatible cellular phone based on the wireless communication technology commonly known as Bluetooth®. It also allows the user to play music, saved in a

Features and controls 5-53

Bluetooth® 2.0 interface (if so equipped)

Bluetooth® music player, from the vehicle's speakers.

The system is equipped with a voice recognition function, which allows you to make hands-free calls by simple switch operations and voice command operations using a defined voice tree.

5

The Bluetooth® 2.0 interface can be used when the electric motor switch is in the "ON" or "ACC" position.

Before you can use the Bluetooth® 2.0 interface, you must pair the Bluetooth® device and Bluetooth® 2.0 interface. Refer to "Connecting the Bluetooth® 2.0 interface and Bluetooth® device" on page 5-59.

Bluetooth® is a registered trademark of BLUETOOTH SIG, INC.

WARNING

- Although the Bluetooth® 2.0 interface allows you to make hands-free calls, if you choose to use the cellular phone while driving, you must not allow yourself to be distracted from the safe operation of your vehicle. Anything, including cellular phone usage, that distracts you from the safe operation of your vehicle increases your risk of an accident.

WARNING

- Refer to and comply with all state and local laws in your area regarding cellular phone usage while driving.

NOTE

- If the electric motor switch is left in the "ACC" position, the accessory power will automatically turn off after a certain period of time and you will no longer be able to use the Bluetooth® 2.0 interface. The accessory power comes on again if the electric motor switch is turned from the "ACC" position. Refer to "ACC power auto-cutout function" on page 5-19.
- The Bluetooth® 2.0 interface cannot be used if the Bluetooth® device has a dead battery or the device power is turned off.
- Hands-free calls will not be possible if your phone does not have service available.
- If you place the Bluetooth® device in the luggage compartment, you may not be able to use the Bluetooth® 2.0 interface.
- Some Bluetooth® devices are not compatible with the Bluetooth® 2.0 interface.
- You can confirm the Link System software version by pressing the HANG-UP button 3 times (press and hold 2 times and then press briefly) within 10 seconds.

NOTE

- For detail of the Bluetooth® 2.0 interface, refer to the following web site:
[For vehicles sold in U.S.A.]
You can access the Mitsubishi Motors North America website.
[For vehicles sold in Canada]
You can access the Mitsubishi Motors website.
Please read and agree to the "Warning about Links to the Web Sites of Other Companies", the websites mentioned above may connect you to websites other than the Mitsubishi Motors website.
<http://www.mitsubishi-motors.com/en/products/index.html>
- Software updates by cellular phone/digital audio device manufacturers may change/alter device connectivity.

Steering control switch and microphone → P.5-55

Voice recognition function → P.5-56

Useful voice commands → P.5-56

Speaker enrollment function → P.5-58

Connecting the Bluetooth® 2.0 interface and the Bluetooth® device → P.5-59

Operating a music player connected via Bluetooth® → P.5-63

How to make or receive hands-free calls → P.5-63

Phonebook function → P.5-66

Steering control switch and microphone

N00564001170

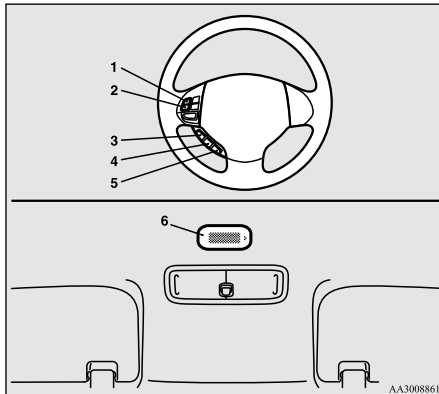

- 1- Volume up button
- 2- Volume down button
- 3- SPEECH button
- 4- PICK-UP button
- 5- HANG-UP button
- 6- Microphone

Volume up button

Press this button to increase the volume.

Volume down button

Press this button to decrease the volume.

SPEECH button

- Pressing this button will activate the voice recognition mode of Mitsubishi Multi-Communication System (a beep will sound when successfully activated). To use the voice recognition of the Bluetooth® 2.0 interface, press the PICK-UP button.
- Pressing the SPEECH button longer will deactivate the voice recognition mode.

PICK-UP button

- Press this button when an incoming call is received to answer the telephone.
- When not receiving incoming calls, pressing the PICK-UP button will activate the voice recognition of the Bluetooth® 2.0 interface.
- When another call is received during a call, press this button to put the first caller on hold and talk to the new caller.
 - In such circumstances, you can press the button briefly to switch between callers. You will switch to the first caller and the other caller will be put on hold.

Bluetooth® 2.0 interface (if so equipped)

- To establish a three-way call in such situations, press the SPEECH button to enter voice recognition mode and then say “Join calls.”

HANG-UP button

- Press this button when an incoming call is received to refuse the call.
- Press this button during a call to end the current call.
 - When another call is on hold, you will switch to that call.
- If this button is pressed in the voice recognition mode, the voice recognition mode will be deactivated.

5

NOTE

- When you press the PICK-UP button to enter voice recognition mode with a cellular phone paired to the system, current information on the cellular phone, such as “remaining battery life,” “signal strength” or “roaming,” will be displayed on the audio display.*
- *: Some cellular phones will not send this information to the Bluetooth® 2.0 interface.
- Call waiting and three-way calls can be used by the Bluetooth® 2.0 interface, only if it is possible to use those services with your cellular phone.

Bluetooth® 2.0 interface (if so equipped)

Microphone

Your voice will be recognized by a microphone in the overhead console, allowing you to make hands-free calls with voice commands.

5

NOTE

- If a cellular phone is within close proximity of the microphone, it may distort the sound quality. In this case, place the cellular phone as far as possible from the microphone.

Voice recognition function

N00564101168

The Bluetooth® 2.0 interface is equipped with a voice recognition function.

Simply say voice commands and you can perform various operations and make or receive hands-free calls.

With the Bluetooth® 2.0 interface, voice recognition is possible for US English, North American Spanish, Canadian French and Japanese. The factory setting is “English.”

NOTE

- If the voice command that you say differs from the predefined command or cannot be recognised due to ambient noise or some other reason, the Bluetooth® 2.0 interface will ask you for the voice command again up to 3 times.
- For best performance and further reduction of ambient noise, the vehicle windows should be closed, lower the blower speed and refrain from conversation with your passengers while engaging the voice recognition function.
- Depending on the selected language, some functions may not be available.

Selecting the language

1. Press the PICK-UP button.
2. Say “Setup.”
3. Say “Language.”
4. The voice guide will say “Select a language: English, Spanish, French or Japanese.” Say the desired language. (Example: “English”)
5. The voice guide will say “English (Spanish, French or Japanese) selected. Is this correct?” Say “Yes.”
If you say “No,” the system will return to Step 4.

NOTE

- The voice guide will repeat the same message twice. The first message is in the current language, and the second message is in the selected language.
- If many entries are registered in the vehicle phonebook, changing the language will take a longer time.
- Changing the language deletes the mobile phonebook imported to the Bluetooth® 2.0 interface. If you wish to use it, you will have to import it again.

6. When the voice guide says “English (Spanish, French or Japanese) selected,” the language change process will be completed and the system will return to the main menu.

Useful voice commands

N00564200016

Help function

N00564300017

The Bluetooth® 2.0 interface is equipped with a help function.

If you say “Help” when the system is waiting for a voice command input, the system will tell you a list of the commands that can be used under the circumstances.

Canceling

N00564400018

There are 2 cancel functions.
If you are at the main menu, say “Cancel” to exit from the Bluetooth® 2.0 interface.
If you are anywhere else within the system, say “Cancel” to return to the main menu.

Confirmation function setting

N00564501061

The Bluetooth® 2.0 interface is equipped with a confirmation function.
With the confirmation function activated, you are given more opportunities than normal to confirm a command when making various settings to the Bluetooth® 2.0 interface. This allows you to decrease the possibility that a setting is accidentally changed.
The confirmation function can be turned on or off by following the steps below.

1. Press the PICK-UP button.
2. Say “Setup.”
3. Say “Confirmation prompts.”
4. The voice guide will say “Confirmation prompts are <on/off>. Would you like to turn confirmation prompts <off/on>.”
Answer “Yes” to change the setting or answer “No” to keep the current setting.

5. The voice guide will say “Confirmation prompts are <off/on>” and then the system will return to the main menu.

Security function

N00564601163

It is possible to use a passcode as a security function by setting a passcode of your choice for the Bluetooth® 2.0 interface.
When the security function is turned on, it is necessary to make a voice input of a 4-digit passcode in order to use all functions of the Bluetooth® 2.0 interface, except for reception.

Setting the passcode

Use the following procedure to turn on the security function by setting a passcode.

1. Press the PICK-UP button.
2. Say “Setup.”
3. Say “Passcode.”
4. The voice guide will say “Passcode is disabled. Would you like to enable it?”
Answer “Yes.”
Answer “No” to cancel the setting of the passcode and return to the main menu.
5. The voice guide will say “Please say a 4-digit passcode. Remember this passcode. It will be required to use this system.”

Bluetooth® 2.0 interface (if so equipped)

Say a 4-digit number which you want to set as a passcode.

6. For confirmation purposes, the voice guide will say “Passcode <4-digit passcode>. Is this correct?” Answer “Yes.”
Answer “No” to return to the passcode input in Step 5.
7. When the registration of the passcode is completed, the voice guide will say “Passcode is enabled” and the system will return to the main menu.

5

NOTE

- Passcode will be required to access the system after restarting the electric motor unit.
- It is required for a little time after the ready indicator has turned off that the entered passcode is actually recorded in the system. If the electric motor switch is made to “ACC” or “ON” or the electric motor is started immediately after the ready indicator has turned off, there is a case when the entered passcode is not recorded in the system. At this time, please try to enter the passcode again.

Entering the passcode

If a passcode has been set and the security function is enabled, the voice guide will say “Hands-free system is locked. State the passcode to continue” when the PICK-UP button is pressed to enter voice recognition mode.

Bluetooth® 2.0 interface (if so equipped)

Say the 4-digit passcode number to enter the passcode.

If the entered passcode is wrong, the voice guide will say “<4-digit passcode>, Incorrect passcode. Please try again.” Enter the correct passcode.

5

NOTE

- You can reenter the passcode as many times as you want.
- If you have forgotten your passcode, say “Cancel” to quit the voice input mode and then check with a certified i-MiEV dealer.

Disabling the passcode

Use the following procedure to turn off the security function by disabling the passcode.

NOTE

- System must be unlocked to disable the passcode.

1. Press the PICK-UP button.
2. Say “Setup.”
3. Say “Passcode.”
4. The voice guide will say “Passcode is enabled. Would you like to disable it?” Answer “Yes.”
Answer “No” to cancel the disabling of the passcode and return to the main menu.

5. When the disabling of the passcode is completed, the voice guide will say “Passcode is disabled” and the system will return to the main menu.

Speaker enrollment function

N00564700011

The Bluetooth® 2.0 interface can use the speaker enrollment function to create a voice model for one person per language.

This makes it easier for the Bluetooth® 2.0 interface to recognise voice commands said by you.

You can turn a voice model registered with the speaker enrollment function on and off whenever you want.

Speaker enrollment

N00564801149

It takes about 2 to 3 minutes to complete the speaker enrollment process.

To ensure the best results, run through the process while in the driver’s seat, in an environment that is as quiet as possible (when there is no rain or strong winds and the vehicle windows are closed). Please turn off your phone while in speaker enrollment to prevent interruption of the process.

Use the following procedure for speaker enrollment.

1. Stop your vehicle in a safe area, put the selector lever in the “P” (PARK) position, and then pull the parking brake lever.

NOTE

- Speaker enrollment is not possible unless the vehicle is parked. Make sure you park the vehicle in a safe area before attempting speaker enrollment.

2. Press the PICK-UP button.
3. Say “Voice training.”
4. The voice guide will say “This operation must be performed in a quiet environment while the vehicle is stopped. See the owner’s manual for the list of required training phrases. Press and release the SPEECH button when you are ready to begin. Press the HANG-UP button to cancel at any time.”

Press the SPEECH button to start the speaker enrollment process.

NOTE

- If you do not start the speaker enrollment process within 3 minutes after pressing the SPEECH button, the speaker enrollment function will time out.
The voice guide will say “Speaker enrollment has timed out.” The system will then beep and the voice recognition mode will be deactivated.

5. The voice guide will prompt for phrase 1. Repeat the corresponding phrase listed in table “Enrollment commands” on page 5-73.

The system will register your voice and then move on to the registration of the next command. Continue the process until all phrases have been registered.

NOTE

- To repeat the most recent voice training command, press and release the SPEECH button.
- If you press the HANG-UP button anytime during the process, the system will beep and stop the speaker enrollment process.

6. When all enrollment commands have been read out, the voice guide will say “Speaker enrollment is complete.” The system will then end the speaker enrollment process and return to the main menu.

NOTE

- Completing the speaker enrollment process will turn on the voice model automatically.
- The commands “Help” and “Cancel” will not work in this mode.

Enabling and disabling the voice model and retraining

N00564901108

You can turn a voice model registered with the speaker enrollment function on and off whenever you want.

You can also retrain the system.

Use the following procedure to perform these actions.

1. Press the PICK-UP button.
2. Say “Voice training.”
3. If you have completed a speaker enrollment process once already, the voice guide will say either “Enrollment is enabled. Would you like to disable or retrain?” or “Enrollment is disabled. Would you like to enable or retrain?”
4. When enrollment is “enabled,” the voice model is on; when enrollment is “disabled,” the voice model is off. Say the command that fits your needs. Say “Retrain” to start the speaker enrollment process and recreate a new voice model. (Refer to “Speaker enrollment” on page 5-58.)

Bluetooth® 2.0 interface (if so equipped)

Connecting the Bluetooth® 2.0 interface and Bluetooth® device

N00565001278

Before you can make or receive hands-free calls or play music using the Bluetooth® 2.0 interface function, you must pair the Bluetooth® device and Bluetooth® 2.0 interface.

5

NOTE

- Pairing is required only when the device is used for the first time. Once the device has been paired with the Bluetooth® 2.0 interface, all you need is to bring the device into the vehicle next time and the device will connect to the Bluetooth® 2.0 interface automatically (if supported by the device).

Up to 7 Bluetooth® devices can be paired with the Bluetooth® 2.0 interface.

If multiple paired Bluetooth® devices are available in the vehicle, the cellular phone or music player most recently connected is automatically connected to the Bluetooth® 2.0 interface.

You can also change a Bluetooth® device to be connected.

Bluetooth® 2.0 interface (if so equipped)

To pair

To pair a Bluetooth® device with the Bluetooth® 2.0 interface, follow the steps below.

5

1. Stop your vehicle in a safe area, put the selector lever in the “P” (PARK) position, and then pull the parking brake lever.

NOTE

- You cannot pair any Bluetooth® device with the Bluetooth® 2.0 interface unless the vehicle is parked. Before pairing a Bluetooth® device with the Bluetooth® 2.0 interface, confirm that the vehicle is parked in a safe location.

2. Press the PICK-UP button.
3. Say “Setup.”
4. Say “Pairing Options.”
5. The voice guide will say “Select one of the following: pair, edit, delete, or list.” Say “Pair.”

NOTE

- If 7 devices have already been paired, the voice guide will say “Maximum devices paired” and then the system will end the pairing process. To register a new device, delete one device and then repeat the pairing process. (Refer to “Deleting a device” on page 5-61.)

6. The voice guide will say “Please say a 4-digit pairing code.” Say a 4-digit number. When the confirmation function is on, the system will confirm whether the number said is acceptable. Answer “Yes.” Answer “No” to return to pairing code selection.

NOTE

- Some Bluetooth® devices require a specific pairing code. Please refer to the device manual for pairing code requirements.

NOTE

- The pairing code entered here is only used for the Bluetooth® connection certification. It is any 4-digit number the user would like to select. Remember the pairing code as it needs to be keyed into the Bluetooth® device later in the pairing process. Depending on the connection settings of the Bluetooth® device, this code may have to be entered each time you connect the Bluetooth® device to the Bluetooth® 2.0 interface. For the default connection settings, refer to the instructions for the device.

7. The voice guide will say “Start pairing procedure on the device. See the device manual for instructions.” Enter in the Bluetooth® device the 4-digit number you have registered in Step 6.

NOTE

- Depending on the device, it might take a few minute to pair the Bluetooth® device with the Bluetooth® 2.0 interface.
- If the Bluetooth® 2.0 interface cannot recognize the Bluetooth® device, the voice guide will say “Pairing has timed out” and the pairing process will be cancelled. Confirm that the device you are pairing supports Bluetooth®, and try pairing it again.

Bluetooth® 2.0 interface (if so equipped)

NOTE

- If you enter the wrong number, the voice guide will say “Pairing failed” and the pairing process will be cancelled. Confirm the number is right, and try pairing it again.

8. The voice guide will say “Please say the name of the device after the beep.” You can assign a desired name for the Bluetooth® device and register it as a device tag. Say the name you want to register after the beep.

NOTE

- When the confirmation function is on, after repeating the device tag you have said, the voice guide will ask “Is this correct?” Answer “Yes.” To change the device tag, answer “No” and then say the device tag again.

9. The voice guide will say “Pairing complete,” and the pairing process will end.

Selecting a device

N00565101123

If multiple paired Bluetooth® devices are available in the vehicle, the cellular phone or music player most recently connected is auto-

matically connected to the Bluetooth® 2.0 interface.

You can connect to the other cellular phone or music player by following setting change procedures.

To select a cellular phone

1. Press the PICK-UP button.
2. Say “Setup.”
3. Say “Select phone.”
4. After the voice guide says “Please say,” the numbers of the cellular phones and device tags of corresponding cellular phones will be read out in order, starting with the cellular phone that has been most recently connected. Say the number of the cellular phone that you want to connect to. When the confirmation function is on, the system will ask you again whether the phone that you want to connect to is correct. Answer “Yes” to continue and connect to the cellular phone. Answer “No,” and the voice guide will say “Please say.” Say the number of the phone that you want to connect to.

NOTE

- You can connect to a phone at any time by pressing the SPEECH button and saying the number, even before all of the paired numbers and device tags of corresponding cellular phones are read out by the system.

5. The selected phone will be connected to the Bluetooth® 2.0 interface. The voice guide will say “<device tag> selected” and then the system will return to the main menu.

To select a music player

1. Press the PICK-UP button.
2. Say “Setup.”
3. Say “Select music player.”
4. After the voice guide says “Please say,” the numbers of the music players and device tags of corresponding music players will be read out in order, starting with the music player that has been most recently connected. Say the number of the music player that you want to connect to. When the confirmation function is on, the system will ask you again whether the music player that you want to connect to is correct. Answer “Yes” to continue and connect to the music player.

Bluetooth® 2.0 interface (if so equipped)

Answer “No,” and the voice guide will say “Please say.” Say the number of the music player that you want to connect to.

NOTE

- You can connect to a music player at any time by pressing the SPEECH button and saying the number, even before all of the paired numbers and device tags of corresponding music players are read out by the system.

5

5. The selected music player will be connected to the Bluetooth® 2.0 interface. The voice guide will say “<device tag> selected” and then the system will return to the main menu.

Deleting a device

Use the following procedure to delete a paired Bluetooth® device from the Bluetooth® 2.0 interface.

1. Press the PICK-UP button.
2. Say “Setup.”
3. Say “Pairing Options.”
4. The voice guide will say “Select one of the following: pair, edit, delete, or list.” Say “Delete.”

5. After the voice guide says “Please say,” the numbers of the devices and device tags of corresponding devices will be read out in order, starting with the device that has been most recently connected. After it completes reading all pairs, the voice guide will say “or all.”

Say the number of the device that you want to delete from the system.

If you want to delete all paired phones from the system, say “All.”

6. For confirmation purposes, the voice guide will say “Deleting <device tag> <number>. Is this correct?” or “Deleting all devices. Is this correct?”

Answer “Yes” to delete the phone(s).

Answer “No,” the system will return to Step 4.

7. The voice guide will say “Deleted,” and then the system will end the device deletion process.

NOTE

- If the device deletion process fails for some reason, the voice guide will say “Delete failed” and then the system will cancel deleting the device.

To check a paired Bluetooth® device

N00565201065

You can check a paired Bluetooth® device by following the steps below.

1. Press the PICK-UP button.
2. Say “Setup.”
3. Say “Pairing Options.”
4. The voice guide will say “Select one of the following: pair, edit, delete, or list.” Say “List.”
5. The voice guide will read out device tags of corresponding devices in order, starting with the Bluetooth® device that has been most recently connected.
6. After the device tags of all paired Bluetooth® devices have been read, the system will say “End of list, would you like to start from the beginning?”

To hear the list again from the beginning, answer “Yes.”

When you are done, answer “No” to return to the main menu.

NOTE

- If you press and release the SPEECH button and say “Continue” or “Previous” while the list is being read, the system will advance or rewind the list.
Say “Continue” to proceed to the device with the next highest number or “Previous” to return to the phone with the previous number.
- You can change the device tag by pressing and releasing the SPEECH button and then saying “Edit” while the list is being read.
- You can change the phone to be connected by pressing and releasing the SPEECH button and then saying “Select phone” while the list is being read.
- You can change the music player to be connected by pressing and releasing the SPEECH button and then saying “Select music player” while the list is being read.

Changing a device tag

N00565301066

You can change the device tag of a paired cellular phone or music player.
Follow the steps below to change a device tag.

1. Press the PICK-UP button.
2. Say “Setup.”
3. Say “Pairing Options.”

4. The voice guide will say “Select one of the following: pair, edit, delete, or list.” Say “Edit.”
5. The voice guide will say “Please say,” and read out the numbers of the Bluetooth® devices and device tags of corresponding devices in order, starting with the Bluetooth® that has been most recently connected.
After all paired device tags have been read, the voice guide will say “Which device, please?” Say the number of the device tag you want to change.

NOTE

- You can press and release the SPEECH button while the list is being read, and immediately say the number of the device tag you want to change.

6. The voice guide will say “New name, please.” Say the name you want to register as a new device tag.
When the confirmation function is on, the voice guide will say “<New device tag>. Is this correct?” Answer “Yes.”
Answer “No,” you can say the new device tag you want to register again.
7. The device tag is changed.

Bluetooth® 2.0 interface (if so equipped)

When the change is complete, the voice guide will say “New name saved” and then the system will return to the main menu.

Operating a music player connected via Bluetooth®

N00565400028

5

For the operation of a music player connected via Bluetooth®, refer to “To play iPod/USB memory device tracks via voice operation” on page 7-20.

How to make or receive hands-free calls

N00565500061

You can make or receive hands-free calls using a Bluetooth® compatible cellular phone connected to the Bluetooth® 2.0 interface.
You can also use the phonebooks in the Bluetooth® 2.0 interface to make calls without dialling telephone numbers.

To make a call P.5-64
Send function P.5-65
Receiving calls P.5-65
Mute function P.5-65
Switching between hands-free mode and private mode P.5-66

Features and controls 5-63

Bluetooth® 2.0 interface (if so equipped)

NOTE

- The hands-free calls might not be operated correctly when it makes calling or receiving by operating the cellular phone directly.

5

To make a call

N00565601131

You can make a call in the following 3 ways using the Bluetooth® 2.0 interface:

Making a call by saying a telephone number, making a call using the Bluetooth® 2.0 interface's phonebook, and making a call by redialing.

Making a call by using the telephone number

You can make a call by saying the telephone number.

1. Press the PICK-UP button.
2. Say "Dial."
3. After the voice guide says "Number please," say the telephone number.
4. The voice guide will say "Dialing <number recognized>."

The Bluetooth® 2.0 interface will then make the call.

When the confirmation function is on, the system will confirm the telephone number again. To continue with that number, answer "Yes."

To change the telephone number, answer "No." The system will say "Number please" then say the telephone number again.

NOTE

- In the case of English, the system will recognize both "zero" and "oh" (Letter "o") for the number "0."
- The Bluetooth® 2.0 interface supports numbers (0 to 9) and characters (+, # and *).
- The maximum supported telephone number length is as follows:
 - International telephone number: + and telephone numbers (to 18 digits).
 - Except for international telephone number: telephone numbers (to 19 digits).

Making a call using a phonebook

You can make calls using the vehicle phonebook or mobile phonebook of the Bluetooth® 2.0 interface.

For details on the phonebooks, refer to "Phonebook function" on page 5-66.

1. Press the PICK-UP button.
2. Say "Call."

NOTE

- If you say "Call" when the vehicle phonebook and the mobile phonebook are empty, the voice guide will say "The vehicle phonebook is empty. Would you like to add a new entry now?"
Answer "Yes," and the voice guide will say "Entering the phonebook - new entry menu." You can now create data in the vehicle phonebook.
Answer "No," the system will return to the main menu.

3. After the voice guide says "Name please," say the name you want to call, from those registered in the phonebook.
4. If there is only 1 match, the system will proceed to Step 5.
If there are 2 or more matches, the voice guide will say "More than one match was found, would you like to call <returned name>." If that person is the one you want to call, answer "Yes."
Answer "No," the name of the next matching person will be uttered by the voice guide.

NOTE

- If you say "No" to all names read by the system, the voice guide will say "Name not found, returning to main menu" and the system will return to the main menu.

5. If only 1 telephone number is registered under the name you just said, the voice guide will proceed to Step 6.

If 2 or more telephone numbers are registered that match the name you just said, the voice guide will say “Would you like to call <name> at [home], [work], [mobile], or [other]?” Select the location to call.

NOTE

- If the name you selected has matching data in the vehicle phonebook but no telephone number is registered under the selected location, the voice guide will say “{home/work/mobile/other} not found for <name>. Would you like to add location or try again?” Say “Try again,” and the system will return to Step 3. Say “Add location” and you can register an additional telephone number under the selected location.
- If the name you selected has matching data in the mobile phonebook but no telephone number is registered under the selected location, the voice guide will say “{home/work/mobile/other} not found for <name>. Would you like to try again?” Answer “Yes,” and the system will return to Step 3. Answer “No,” and the call making will be cancelled. Start over again from Step 1.

6. The voice guide will say “Calling <name> <location>” and then the system will dial the telephone number.

NOTE

- When the confirmation function is on, the system will check if the name and location of the receiver are correct. If the name is correct, answer “Yes.” To change the name or location to call, answer “No.” The system will return to Step 3.

Redialing

You can redial the last number called, based on the history of dialed calls in the paired cellular phone.

Use the following procedure to redial.

1. Press the PICK-UP button.
2. Say “Redial.”

Send function

N00565700018

During a call, press the SPEECH button to enter voice recognition mode, then say “<numbers> SEND” to generate DTMF tones.

For example, if during a call you need to simulate the pressing of a phone button as a response to an automated system, press the

Bluetooth® 2.0 interface (if so equipped)

SPEECH button and speak “1 2 3 4 pound send” and the 1234# will be sent via your cellular phone.

Receiving calls

N00565800022

5

If an incoming phone call is received while the electric motor switch is in the “ACC” or “ON” position, the audio system will be automatically turned on and switched to the incoming call, even when the audio system was originally off.

The voice guide announcement for the incoming call will be output from the front passenger’s seat speaker.

If the CD player or radio was playing when the incoming call was received, the audio system will mute the sound from the CD player or radio and output only the incoming call.

To receive the call, press the PICK-UP button on the steering wheel control switch.

When the call is over, the audio system will return to its previous state.

Mute function

N00565900010

At any time during a call, you can mute the vehicle microphone.

Pressing the SPEECH button and then saying “Mute” during a call will turn ON the mute function and mute the microphone.

Bluetooth® 2.0 interface (if so equipped)

Saying “Mute off” in the same way will turn off the mute function and cancel the mute on the microphone.

Switching between hands-free mode and private mode

N00566600014

5

The Bluetooth® 2.0 interface can switch between hands-free mode (hands-free calls) and private mode (calls using cellular phone). If you press the SPEECH button and say “Transfer call” during a hands-free call, you can stop the hands-free mode and talk in private mode.

To return to hands-free mode, press the SPEECH button again and say “Transfer call.”

Phonebook function

N00566000018

The Bluetooth® 2.0 interface has 2 types of unique phonebooks that are different from the phonebook stored in the cellular phone. They are the vehicle phonebook and the mobile phonebook.

These phonebooks are used to register telephone numbers and make calls to desired numbers via voice recognition function.

5-66 Features and controls

NOTE

- Disconnecting the battery cable will not delete information registered in the phonebook.

Vehicle phonebook

N00566101120

This phonebook is used when making calls with the voice recognition function. Up to 32 names can be registered in the vehicle phonebook per language.

Also, each entry has 4 locations associated with: home, work, mobile and other. You can register one telephone number for each location.

You can register a desired name as a name for any phonebook entry registered in the vehicle phonebook.

Names and telephone numbers can be changed later on.

The vehicle phonebook can be used with all paired cellular phones.

■ To register a telephone number in the vehicle phonebook

N00580500059

You can register a telephone number in the vehicle phonebook in the following 2 ways: Reading out a telephone number, and select-

ing and transferring 1 phonebook entry from the phonebook of the cellular phone.

■ To register by reading out a telephone number

N00580600106

1. Press the PICK-UP button.
2. Say “Phonebook.”
3. The voice guide will say “Select one of the following: new entry, edit number, edit name, list names, delete, erase all, or import contact.” Say “New entry.”
4. The voice guide will say “Name please.” Say your preferred name to register it.

NOTE

- If the maximum number of entries are already registered, the voice guide will say “The phonebook is full. Would you like to delete a name?” Say “Yes” if you want to delete a registered name. If you say “No,” the system will return to the main menu.

5. When the name has been registered, the voice guide will say “home, work, mobile, or other?” Say the location for which you want to register a telephone number.

Bluetooth® 2.0 interface (if so equipped)

NOTE

- When the confirmation function is on, the voice guide will say “<Location>. Is this correct?” Answer “Yes.” Answer “No” to return to location selection in Step 5. If a telephone number has been registered for the selected location, the voice guide will say “The current number is <telephone number>, number please.” If you do not want to change the telephone number, say “cancel” or the original number to keep it registered.

6. The voice guide will say “Number please.” Say the telephone number to register it.

NOTE

- In the case of English, the system will recognize both “zero” and “oh” (Letter “o”) for the number “0.”

7. The voice guide will repeat the telephone number you have just read, and then register the number.
When the telephone number has been registered, the voice guide will say “Number saved. Would you like to add another number for this entry?”

To add another telephone number for a new location for the current entry, answer “Yes.” The system will return to location selection in Step 5.
Answer “No” to end the registration process and return to the main menu.

NOTE

- When the confirmation function is on, after repeating the telephone number you have read, the voice guide will ask “Is this correct?” Answer “Yes.” Answer “No” to return to telephone number registration in step 6.

■ To select and transfer one phonebook entry from the phonebook of the cellular phone

N00580700080

You can select 1 phonebook entry from the phonebook of the cellular phone and register it in the vehicle phonebook.

NOTE

- Transfer is not permitted unless the vehicle is parked. Before transferring, make sure that the vehicle is parked in a safe location.
- All or part of data may not be transferred, even when the cellular phone supports Bluetooth®, depending on the compatibility of the device.

NOTE

- The maximum supported telephone number length is 19 digits. Any telephone number of 20 digits or more will be truncated to the first 19 digits.
- If telephone numbers contain characters other than 0 to 9, *, # or +, these characters are deleted before the transfer.
- For the connection settings on the cellular phone side, refer to the instructions for the cellular phone.

1. Press the PICK-UP button.
2. Say “Phonebook.”
3. The voice guide will say “Select one of the following: new entry, edit number, edit name, list names, delete, erase all, or import contact.” Say “Import contact.”
4. The voice guide will say “Would you like to import a single entry or all contacts?” Say “Single entry.”

The Bluetooth® 2.0 interface will become ready to receive transferred phonebook data.

NOTE

- If the maximum number of entries are already registered, the voice guide will say “The phonebook is full. Would you like to delete a name?” Say “Yes” if you want to delete a registered name. If you say “No,” the system will return to the main menu.

Bluetooth® 2.0 interface (if so equipped)

5. After the voice guide says “Ready to receive a contact from the phone. Only a home, a work, and a mobile number can be imported,” the Bluetooth® 2.0 interface will receive the phonebook data from the Bluetooth® compatible cellular phone.

5

6. Operate the Bluetooth® compatible cellular phone to set it up so that the phonebook entry you want to register in the vehicle phonebook can be transferred to the Bluetooth® 2.0 interface.

NOTE

- If the Bluetooth® 2.0 interface cannot recognise the Bluetooth® compatible cellular phone or the connection takes too much time, the voice guide will say “Import contact has timed out” and then the system will cancel the registration. In such case, start over again from Step 1.
- Pressing the HANG-UP button or pressing and holding the SPEECH button will cancel the registration.

7. When the reception is complete, the voice guide will say “<Number of telephone numbers that had been registered in the import source> numbers have been imported. What name would you like to use for these numbers?”

Say the name you want to register for this phonebook entry.

NOTE

- If the entered name is already used for other phonebook entry or similar to a name used for other phonebook entry, that name cannot be registered.

8. The voice guide will say “Adding <name>.”

When the confirmation function is on, the system will ask if the name is correct. Answer “Yes.”

Answer “No,” the voice guide will say “Name please.” Register a different name.

9. The voice guide will say “Numbers saved.”

10. The voice guide will say “Would you like to import another contact?”

Answer “Yes” if you want to continue with the registration. You can continue to register a new phonebook entry from Step 5.

Answer “No,” the system will return to the main menu.

■ To change the content registered in the vehicle phonebook

N00579800049

You can change or delete a name or telephone number registered in the vehicle phonebook.

You can also listen to the list of names registered in the vehicle phonebook.

NOTE

- The system must have at least one entry.

◆ Editing a telephone number

N00579900082

1. Press the PICK-UP button.
2. Say “Phonebook.”
3. The voice guide will say “Select one of the following: new entry, edit number, edit name, list names, delete, erase all, or import contact”. Say “Edit number.”
4. The voice guide will say “Please say the name of the entry you would like to edit, or say list names.” Say the name of the phonebook entry you want to edit.

NOTE

- Say “List names,” and the names registered in the phonebook will be read out in order. Refer to “Listening to the list of registered names” on page 5-69.

5. The voice guide will say “Home, work, mobile or other?” Select and say the location where the telephone number you want to change or add is registered.

When the confirmation function is on, the system will check the target name and location again. Answer “Yes” if you want to continue with the editing.

Answer “No,” the system will return to Step 3.

- The voice guide will say “Number, please.” Say the telephone number you want to register.

NOTE

- If the telephone number is already registered in the selected location, the voice guide will say “The current number is <current number>. New number, please.” Say a new telephone number to change the current number.

- The voice guide will repeat the telephone number.

When the confirmation function is on, the system will ask if the number is correct. Answer “Yes.”

Answer “No,” the system will return to the Step 3.

- Once the telephone number is registered, the voice guide will say “Number saved” and then the system will return to the main menu.

NOTE

- If the location where a telephone number was already registered has been overwritten with a new number, the voice guide will say “Number changed” and then the system will return to the main menu.

◆ Editing a name

N00580100084

- Press the PICK-UP button.
- Say “Phonebook.”
- The voice guide will say “Select one of the following: new entry, edit number, edit name, list names, delete, erase all, or import contact.” Say “Edit name.”
- The voice guide will say “Please say the name of the entry you would like to edit, or say list names.” Say the name you want to edit.

NOTE

- Say “List names,” and the names registered in the phonebook are read out in order. Refer to “Listening to the list of registered names” on page 5-69.

- The voice guide will say “Changing <name>.”

Bluetooth® 2.0 interface (if so equipped)

When the confirmation function is on, the system will check if the name is correct. Answer “Yes” if you want to continue with the editing based on this information. Answer “No,” the system will return to Step 4.

- The voice guide will say “Name please.” Say the new name you want to register.
- The registered name will be changed. When the change is complete, the system will return to the main menu.

5

◆ Listening to the list of registered names

N00580200072

- Press the PICK-UP button.
- Say “Phonebook.”
- The voice guide will say “Select one of the following: new entry, edit number, edit name, list names, delete, erase all, or import contact.” Say “List names.”
- Bluetooth® 2.0 interface will read out the entries in the phonebook in order.
- When the voice guide is done reading the list, it will say “End of list, would you like to start from the beginning?” When you want to check the list again from the beginning, answer “Yes.” When you are done, answer “No” to return to the previous or main menu.

Bluetooth® 2.0 interface (if so equipped)

5

 **NOTE**

- You can call, edit or delete a name that is being read out.
Press the SPEECH button and say “Call” to call the name, “Edit name” to edit it, or “Delete” to delete it.
The system will beep and then execute your command.
- If you press the SPEECH button and say “Continue” or “Previous” while the list is being read, the system will advance or rewind the list. Say “Continue” to proceed to the next entry or “Previous” to return to the previous entry.

◆ **Deleting a telephone number**

N00580300099

1. Press the PICK-UP button.
2. Say “Phonebook.”
3. The voice guide will say “Select one of the following: new entry, edit number, edit name, list names, delete, erase all, or import contact.” Say “Delete.”
4. The voice guide will say “Please say the name of the entry you would like to delete, or say list names.” Say the name of the phonebook entry in which the telephone number you want to delete is registered.

 **NOTE**

- Say “List names,” and the names registered in the phonebook are read out in order. Refer to “Listening to the list of registered names” on page 5-69.

5. If only one telephone number is registered in the selected phonebook entry, the voice guide will say “Deleting <name> <location>.”

If multiple telephone numbers are registered in the selected phonebook entry, the voice guide will say “Would you like to delete [home], [work], [mobile], [other], or all?”

Select the location to delete, and the voice guide will say “Deleting <name> <location>.”

 **NOTE**

- To delete the telephone numbers from all locations, say “All.”

6. The system will ask if you really want to delete the selected telephone number(s) to go ahead with the deletion, answer “Yes.” Answer “No,” the system will cancel deleting the telephone number(s) and then return to Step 4.

7. When the telephone number deletion is complete, the voice guide will say “<name> <location> deleted” and then the system will return to the main menu.
If all locations are deleted, the system will say “<name> and all locations deleted” and the name will be removed from the phonebook. If numbers still remain under the entry, the name will retain the other associated numbers.

■ **Erasing the phonebook**

N00580400074

You can delete all registered information from the vehicle phonebook.

1. Press the PICK-UP button.
2. Say “Phonebook.”
3. The voice guide will say “Select one of the following: new entry, edit number, edit name, list names, delete, erase all, or import contact.” Say “Erase all.”
4. For confirmation purposes, the voice guide will ask “Are you sure you want to erase everything from your hands-free system phonebook?” Answer “Yes.” Answer “No” to cancel the deletion of all registered information in the phonebook and return to the main menu.

5. The voice guide will say “You are about to delete everything from your hands-free system phonebook. Do you want to continue?” Answer “Yes” to continue. Answer “No” to cancel the deletion of all registered information in the phonebook and return to the main menu.
6. The voice guide will say “Please wait, erasing the hands-free system phonebook” and then the system will delete all data in the phonebook. When the deletion is complete, the voice guide will say “Hands-free system phonebook erased” and then the system will return to the main menu.

Mobile phonebook

N00566201105

All entries in the phonebook stored in the cellular phone can be transferred in a batch and registered in the mobile phonebook. Up to 7 mobile phonebooks, each containing up to 1,000 names, can be registered.

The Bluetooth® 2.0 interface automatically converts from text to voice the names registered in the transferred phonebook entries, and creates names.

NOTE

- Only the mobile phonebook transferred from the connected cellular phone can be used with that cellular phone.
- You cannot change the names and telephone numbers in the phonebook entries registered in the mobile phonebook. You cannot select and delete specific phonebook entries, either. To change or delete any of the above, change the applicable information in the source phonebook of the cellular phone and then transfer the phonebook again.

To import a devices phonebook

Follow the steps below to transfer to the mobile phonebook the phonebook stored in the cellular phone.

NOTE

- Transfer should be completed while the vehicle is parked. Before transferring, make sure that the vehicle is parked in a safe location.
- The already stored phonebook in the mobile phonebook is overwritten by the stored phonebook in the cellular phone.
- All or part of data may not be transferred, even when the cellular phone supports Bluetooth®, depending on the compatibility of the device.
- Only a home, a work, and a mobile number can be imported.

Bluetooth® 2.0 interface (if so equipped)

NOTE

- The maximum supported telephone number length is 19 digits. Any telephone number of 20 digits or more will be truncated to the first 19 digits.
- If telephone numbers contain characters other than 0 to 9, *, # or +, these characters are deleted before the transfer.
- For the connection settings on the cellular phone side, refer to the instructions for the cellular phone.

5

1. Press the PICK-UP button.
2. Say “Phonebook.”
3. The voice guide will say “Select one of the following: new entry, edit number, edit name, list names, delete, erase all, or import contact.” Say “Import contact.”
4. The voice guide will say “Would you like to import a single entry or all contacts?” Say “All contacts.”
5. The voice guide will say “Importing the contact list from the mobile phonebook. This may take several minutes to complete. Would you like to continue?” Answer “Yes,” transferring to the mobile phonebook the phonebook stored in the cellular phone will start. Answer “No,” the system will return to the main menu.

Bluetooth® 2.0 interface (if so equipped)

5

 **NOTE**

- The transfer may take some time to complete depending on the number of contacts.
- If the Bluetooth® 2.0 interface could not be connected to the Bluetooth® compatible cellular phone, the voice guide will say “Unable to transfer contact list from phone” and then the system will return to the main menu.
- If you press the HANG-UP button or press and hold the SPEECH button during the data transfer, the transfer will be cancelled and the system will return to the main menu.
- If an error occurs during the data transfer, all transfer will be cancelled and the voice guide will say “Unable to complete the phonebook import” and then the system will return to the main menu.
- If there are no contacts in the phonebook, the voice guide will say “There are no contacts on the connected phone.”

6. When the transfer is complete, the voice guide will say “Import complete” and then the system will return to the main menu.

General information

N00566301092

MODEL: MMC FCC ID: CB2MDGMY10
IC: 279B-MDGMY10

5-72 Features and controls

Your Bluetooth® 2.0 interface operates on a radio frequency subject to Federal Communications Commission (FCC) Rules (For vehicles sold in U.S.A.) and Industry Canada Rules (For vehicles sold in Canada). This device complies with Part 15 of the FCC Rules and RSS-210 of the Industry Canada Rules. Operation is subject to the following two conditions:

- This device may not cause harmful interference.
- This device must accept any interference received, including interference that may cause undesired operation.

 **CAUTION**

- Changes or modifications made to this equipment not expressly approved by the manufacturer may void the FCC authorization to operate this equipment.

The term “IC:” before the radio certification number only signifies that Industry Canada technical specifications were met.

The antenna used for this transmitter must not be co-located or operating in conjunction with any other antenna or transmitter. End-users and installers must be provided with installation instructions and transmitter operating conditions for satisfying RF exposure compliance.

FCC Notice: This equipment has been tested and found to comply with the limits for a Class B digital device, pursuant to part 15 of the FCC Rules. These limits are designed to provide reasonable protection against harmful interference in a residential installation.

This equipment generates, use and can radiate radio frequency energy and, if not installed and used in accordance with the instructions, may cause harmful interference to radio communications.

However, there is no guarantee that interference will not occur in a particular installation. If this equipment does cause harmful interference to radio or television reception, which can be determined by turning the equipment off and on, the user is encouraged to try to correct the interference by one or more of the following measures:

- Reorient or relocate the receiving antenna.
- Increase the separation between the equipment and receiver.
- Connect the equipment into an outlet on a circuit different from that to which the receiver is connected.
- Consult the dealer or an experienced radio/TV technician for help.

ICES Notice: This Class B digital apparatus complies with Canadian ICES-003.

Enrollment commands

N00566401080

Phrase	English	Spanish	French	Japanese
1	123456789	123456789	123456789	123456789
2	888 555 1212	888 555 1212	888 555 1212	888 555 1212
3	Call	Llamar	Appeler	呼び出し
4	Dial	Marcar	Composer	ダイヤル
5	Setup	Configurar	Configurer	設定
6	Cancel	Cancelar	Annuler	キャンセル
7	Continue	Continuar	Continuer	つぎ
8	Help	Ayuda	Aide	ヘルプ

USB input terminal (if so equipped)

N00566701041

You can connect your USB memory device or iPod* to play music files stored in the USB memory device or iPod.

The following explains how to connect and remove a USB memory device or iPod.

*: “iPod” is a registered trademark of Apple Inc. in the United States and other countries.

How to connect a USB memory device

N00566800087

1. Park your vehicle in a safe place and turn the electric motor switch to the “LOCK” position.
2. Open the USB input terminal cover (A) in the floor console.

USB input terminal (if so equipped)

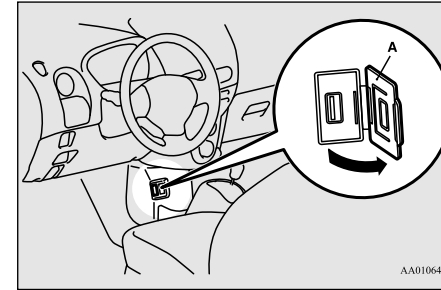

5

3. Connect a commercially available USB connector cable (C) to the USB memory device (B).

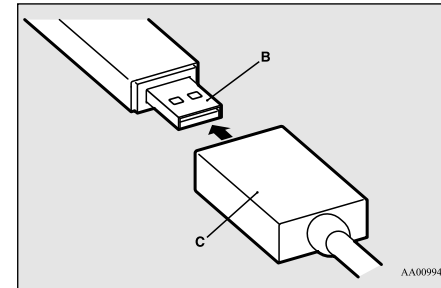

4. Connect the USB connector cable (C) to the USB input terminal (D).

USB input terminal (if so equipped)

5

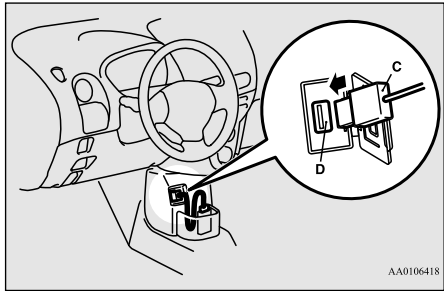

AA0106418

⚠ WARNING

- Place the USB memory device and the USB connector cable so as not to interfere with driving.

📖 NOTE

- Do not connect the USB memory device to the USB input terminal directly. The USB memory device may be damaged.

5. To remove the USB connector cable, turn the electric motor switch to the “LOCK” position first and perform the installation steps in reverse.

How to connect an iPod

N00566900075

1. Park your vehicle in a safe place and turn the electric motor switch to the “LOCK” position.
2. Open the USB input terminal cover (A) in the floor console.

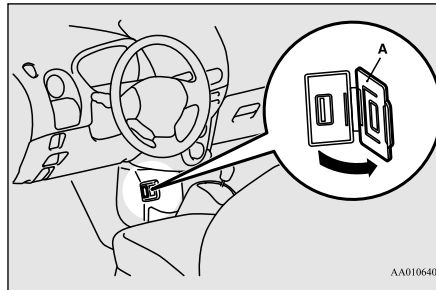

AA0106405

3. Connect the Dock connector (C) to the iPod (B).

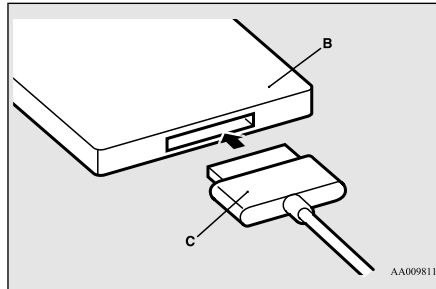

AA0098115

📖 NOTE

- Use a genuine Dock connector from Apple Inc.

4. Connect the Dock connector (C) to the USB input terminal (D).

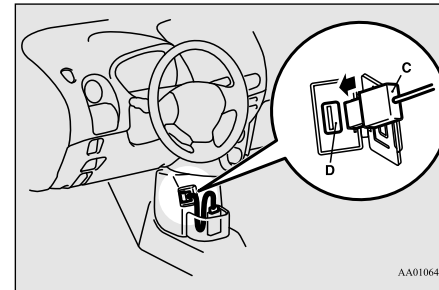

AA0106418

⚠ WARNING

- Place the iPod and the USB connector cable so as not to interfere with driving.

5. To remove the Dock connector, turn the electric motor switch to the “LOCK” position first and perform the installation steps in reverse.

Types of connectable devices and supported file specifications

N00567000031

Device types

N00567101169

Devices of the following types can be connected.

Model name	Condition
USB memory device	Storage capacity of 256 Mbytes or more
Models other than USB memory devices and iPods	Digital audio player supporting mass storage class

For these connectable device types, “iPod*,” “iPod classic*,” “iPod nano*,” “iPod touch*” and “iPhone*,” refer to the following website:

[For vehicles sold in U.S.A.]

You can access the Mitsubishi Motors North America website.

[For vehicles sold in Canada]

You can access the Mitsubishi Motors website. Please read and agree to the “Warning about Links to the Web Sites of Other Companies”. The websites mentioned above may

connect you to websites other than the Mitsubishi Motors website.

<http://www.mitsubishi-motors.com/en/products/index.html>

*: “iPod,” “iPod classic,” “iPod nano,” “iPod touch,” and “iPhone” are registered trademarks of Apple Inc. in the United States and other countries.

NOTE

- Depending on the type of the USB memory device or other device connected, the connected device may not function properly or the available functions may be limited.
- It is recommended to use an iPod with firmware updated to the latest version.
- You can charge your iPod by connecting it to the USB input terminal when the electric motor switch is in the “ACC” or “ON” position.
- Do not keep your USB memory device or iPod in your vehicle.
- It is recommended that you back up the files in case of data damage.
- Do not connect to the USB input terminal any device (hard disk, card reader, memory reader, etc.) other than the connectable devices specified in the previous section. The device and/or data may be damaged. If any of these devices was connected by mistake, remove it after turning the electric motor switch to the “LOCK” position.

USB input terminal (if so equipped)

File specifications

N00567201069

You can play music files of the following specifications that are saved in a USB memory device or other device supporting mass storage class. When you connect your iPod, playable file specifications depend on the connected iPod.

5

Item	Condition
File format	MP3, WMA, AAC, WAV
Maximum number of levels (including the root)	Level 8
Number of folders	700
Number of files	65,535

Sun visors

Sun visors

N00524600340

Fold the sun visor downward (1) to reduce front glare while driving. To reduce side glare, turn the visor to the side (2).

5

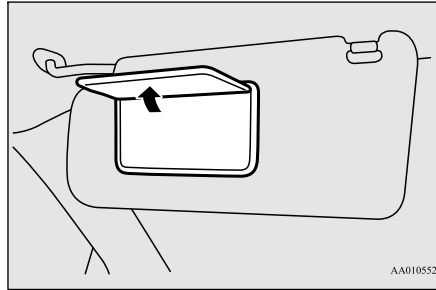
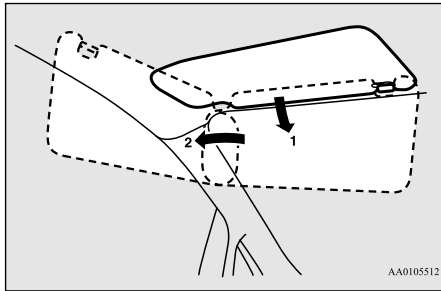

Card holder

Cards can be slipped into the front (A) of the lid of the vanity mirror.

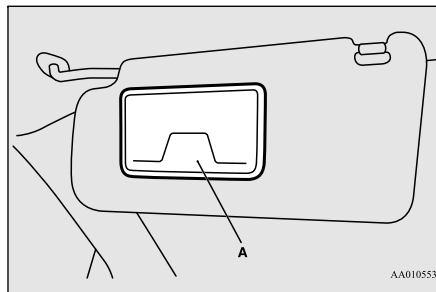

Vanity mirror

A vanity mirror is fitted to the back of the sun visor.

12 V power outlet

N00525000602

CAUTION

- Be sure to use a “plug-in” type accessory operating at 12 V and 120 W or less.
- Be aware that using electronic equipment with the ready indicator off may run the 12 V starter battery down.
- When the 12 V power outlet is not in use, be sure to close the 12 V power outlet cover. This will prevent the 12 V power outlet from becoming dirty and possibly short-circuiting.

The accessory can be operated when the electric motor switch is in the “ON” or “ACC” position.

To use a “plug-in” type accessory, open the cover, then insert the plug in the socket.

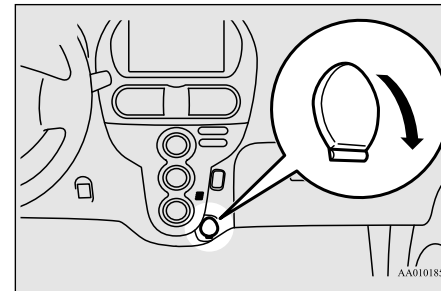

Interior lights

Interior lights

N00525300559

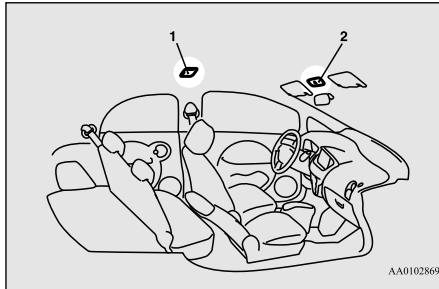

AA0102869

- 1- Dome light (Rear) → P.5-78
- 2- Dome light (Front)/Reading lights → P.5-77

Dome light (Front)/Reading lights (if so equipped)

N00525800222

Dome light (Front)

The dome light can be turned on by sliding the dome light switch.

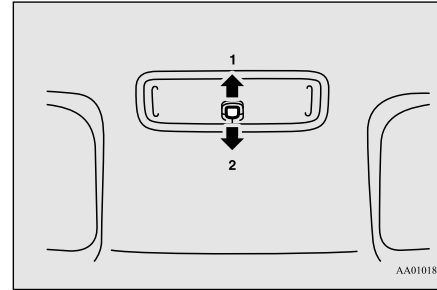

AA0101875

- 1- Door
- 2- Off

1- (DOOR)

- The dome light comes on when any door or the liftgate is opened. It goes off approximately 30 seconds after the door or liftgate is closed (delayed off function). However, the light goes off immediately if:
 - The door and the liftgate are closed and the electric motor switch is turned to the “ON” position.
 - The driver’s door is closed after all the other doors are closed while the lock knob of the driver’s door is in the lock position.
 - The door and the liftgate are closed and the power door lock switch is used to lock the doors.
 - The keyless entry system remote control transmitter is used to lock the doors.

5

Interior lights

- If the dome light is left switched on with the electric motor switch in the “LOCK” or “ACC” position and a door or the liftgate is opened, it goes off automatically after approximately 30 minutes.

The light will illuminate again after it automatically goes off in the following cases:

- When the electric motor switch is turned to the “ON” position.
- When the keyless entry system remote control transmitter is operated.
- When any of the doors or the liftgate is opened after all doors and the liftgate are closed.

NOTE

- When the key is removed while the doors and liftgate are closed, the dome light will illuminate for approximately 30 seconds before going off.
- The time until the light goes off (delayed off) can be adjusted. See a certified i-MiEV dealer for details.

However, the dome light will shut off in sync with the automatic relocking function, even if the dome light delayed off function has been extended. For the automatic relocking function, refer to “Keyless entry system” on page 5-5.

NOTE

- The auto cut-out function can be deactivated. See a certified i-MiEV dealer for details.

- 2- The dome light goes off.

Reading lights

N00553800096

Regardless of the dome light switch position, when you press the lens, the light on the side that is pressed illuminates; when you press the lens again, the light goes off.

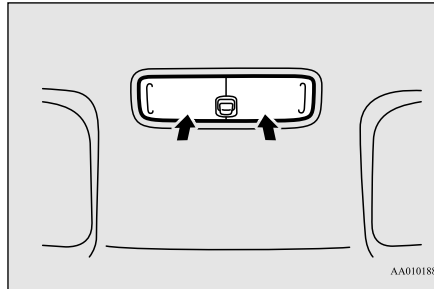

Dome light (Rear)

N00525400459

The rear dome light can be turned on by sliding the dome light switch.

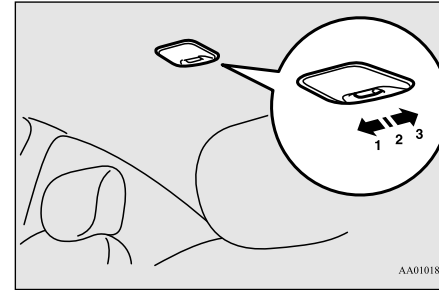

- 1- On
- 2- Door
- 3- Off

- 1- (ON)
The dome light comes on.
- 2- (●)

Storage spaces

- The dome light comes on when any door or the liftgate is opened. It goes off approximately 30 seconds after the door or liftgate is closed (delayed off function). However, the light goes off immediately if:
 - The door and the liftgate are closed and the electric motor switch is turned to the “ON” position.
 - The driver’s door is closed after all the other doors are closed while the lock knob of the driver’s door is in the lock position.
 - The door and the liftgate are closed and the power door lock switch is used to lock the doors.
 - The keyless entry system remote control transmitter is used to lock the doors.

- If the dome light is left switched on with the electric motor switch in the “LOCK” or “ACC” position and a door or the liftgate is opened, it goes off automatically after approximately 30 minutes. The light will illuminate again after it automatically goes off in the following cases:
 - When the electric motor switch is turned to the “ON” position.
 - When the keyless entry system remote control transmitter is operated.
 - When any of the doors or the liftgate is opened after all doors and the liftgate are closed.

NOTE

- When the key is removed while the doors and liftgate are closed, the dome light will illuminate for approximately 30 seconds before going off.
- The time until the light goes off (delayed off) can be adjusted. See a certified i-MiEV dealer for details. However, the dome light will shut off in sync with the automatic relocking function, even if the dome light delayed off function has been extended. For the automatic relocking function, refer to “Keyless entry system” on page 5-5.

NOTE

- The auto cut-out function cannot be operated when the dome light switch is in the “ON” position. Also, this function can be deactivated. See a certified i-MiEV dealer for details.

3- (OFF)

The dome light goes off.

5

Storage spaces

N00526400502

CAUTION

- Never leave lighters, carbonated drink cans, or spectacles in the cabin when parking the vehicle in hot sunshine. The cabin will become extremely hot, so lighters and other flammable items may catch fire and unopened drink cans (including beer cans) may rupture. The heat may also deform or crack plastic spectacle parts.
- Keep the lids of storage spaces closed while driving the vehicle. A lid or the contents of a storage space could otherwise cause injuries during a sudden stop.

NOTE

- Do not leave valuables in any storage space when leaving the vehicle.

Cup holder

Glove compartment

N00551500259

To open the glove compartment, pull the lever (A).

5

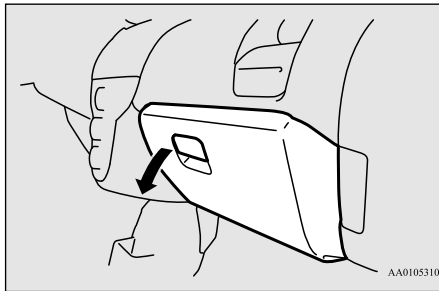

AA0105310

! WARNING

- An open glove compartment door can cause a serious injury or death to the front passenger in an accident, even if the passenger is wearing his/her seat belt. Always keep the glove compartment door closed when driving.

Card holder

N00571400010

There is a card holder on the inside of the glove compartment.

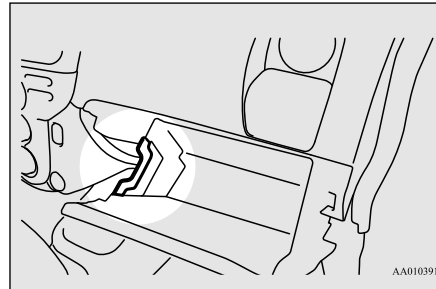

AA0103912

Cup holder

N00527300364

For the front seat

The cup holder is located in front of the side vent.

The cup holder is designed for holding cups or drink-cans securely in its holes.

Tip the cup holder toward you to use it.

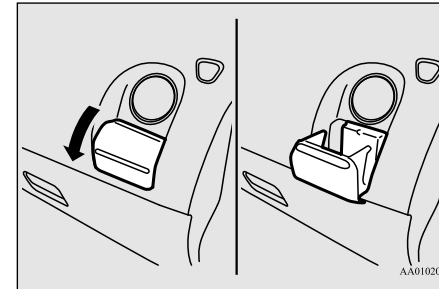

AA0102090

! CAUTION

- Do not drink beverages while driving your vehicle. This is distracting and could cause an accident.

NOTE

- When not using the holder, push the holder in to stow it away.
- Do not put your hand on the cup holder while getting in or out of the vehicle. The cup holder could break.
- Never place anything other than cup or drink can in the cup holder.

For the rear seat

N00537000146

This cup holder is located behind the parking brake lever.



Assist grip

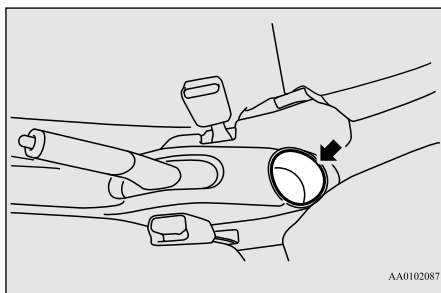

CAUTION

- Do not use the assist grips when getting into or out of the vehicle. The assist grips could detach and cause an accident.

5

Assist grip

N00559000058

These grips are to support the body by hand while seated in the vehicle.

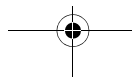
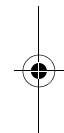
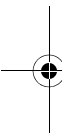
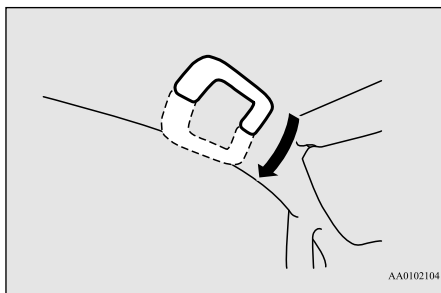

Features and controls 5-81



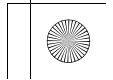
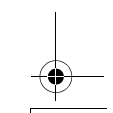
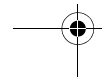
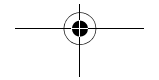
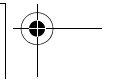
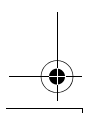
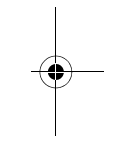
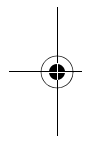
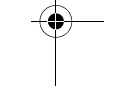
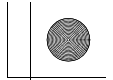
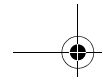
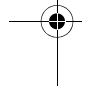
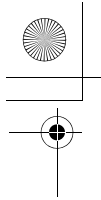

Multiple horizontal dashed lines for writing or printing.



Driving safety

Economical driving	6-2
Driving, alcohol and drugs	6-2
Floor mat	6-2
Vehicle preparation before driving	6-3
Safe driving techniques	6-4
Driving during cold weather	6-4
Braking	6-5
Parking	6-6
Loading information	6-6
Cargo loads	6-10
Trailer towing	6-10
Dinghy towing	6-10



Economical driving

Economical driving

N00628500029

For economical driving, there are some technical requirements that have to be met. In order to achieve longer life of the vehicle and the most economical operation, we recommend you to have the vehicle checked at regular intervals according to the “WARRANTY AND MAINTENANCE MANUAL”.

Starting and acceleration

Avoid driving with the accelerator pedal fully depressed, such as for unnecessarily sudden starts, acceleration and deceleration. Smoothly depress the accelerator pedal. Observe the speed limit and keep the speed as constant as possible while driving.

Idling

Parking for a long period with the ready indicator illuminated will shorten the cruising range.

Speed

At higher the vehicle speed the more main drive lithium-ion battery is consumed. Avoid

driving at full speed. Even a slight release of the accelerator pedal will save a significant amount of main drive lithium-ion battery charge.

Tire inflation pressure

Check the tire inflation pressures at regular intervals. Low tire inflation pressure increases road resistance. In addition, low tire pressures adversely affect tire wear and driving stability.

Cargo loads

Do not drive with unnecessary articles in the luggage compartment.

Air conditioning

Too much cooling/heating can affect the cruising range, so maintain an appropriate temperature to extend the cruising range.

Driving, alcohol and drugs

N00628900010

Drunk driving is one of the most frequent causes of accidents.

Your driving ability can be seriously impaired even with blood alcohol levels far below the legal minimum. If you have been drinking, don't drive. Ride with a designated non-drinking driver, call a cab or a friend, or use public transportation. Drinking coffee or taking a cold shower will not make you sober. Similarly, prescription and nonprescription drugs affect your alertness, perception and reaction time. Consult with your doctor or pharmacist before driving while under the influence of any of these medications.

WARNING

- NEVER DRINK AND DRIVE.

Your perceptions are less accurate, your reflexes are slower and your judgment is impaired.

Floor mat

N00628600017

The original equipment floor mat provided with your vehicle was specifically designed for your vehicle. Always properly position the floor mat and assure it does not interfere with operation of the pedals. Always use the retaining clip on the driver's floorboard to secure the floor mat. When used, this clip will help prevent the floor mat from moving forward and possibly interfering with the operation of the pedals. To prevent the floor mat

from moving forward and possibly interfering with the operation of the pedals, Mitsubishi genuine floor mats are recommended.

To install the floor mat

N00628700063

1. Place the floor mat to fit the shape of the floorboard.
2. Align the floor mat with the installation holes over the retaining clips.
3. Secure the floor mat with retaining clips.

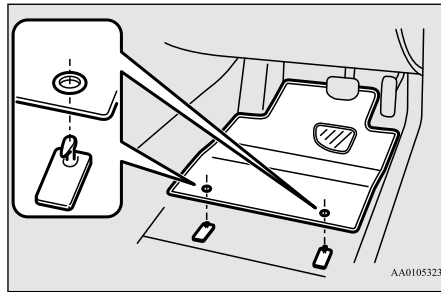

AA0105323

NOTE

- The shape of the mat and the number of retaining clips may vary depending on the vehicle model.

WARNING

- If a floor mat is the wrong size or is not properly installed, it can interfere with the operation of the pedals. Interference with the pedals can cause unintended acceleration and/or increased stopping distances resulting in a crash and injury. Always make sure the floor mat does not interfere with the accelerator or brake pedal.
- Always use the retaining clip on the driver's floorboard to secure the floor mat.
- Always install the mat with the correct side facing down.
- Never install a second mat over or under an existing floor mat.
- Do not use a floor mat designed for another model vehicle even if it is a Mitsubishi genuine floor mat.
- Before driving, be sure to check the following:
 - Periodically check that the floor mat is properly secured with the retaining clips. If you remove the floor mat while cleaning the inside of your vehicle or for any other reason, always check the condition of the floor mat after it has been reinstalled.
 - While the vehicle is stopped with the electric motor unit off, check that the floor mat is not interfering with the pedals by depressing the pedals fully.

Vehicle preparation before driving

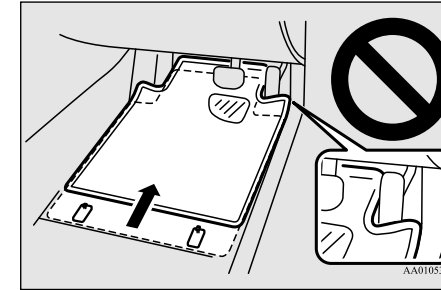

AA0105336

6

Vehicle preparation before driving

N00629000698

For a safer and more enjoyable trip, always observe the following:

Seat belts and seats

- Before starting the vehicle, make certain that you and all passengers are seated and wearing their seat belts properly (with children in the rear seat, in appropriate restraints), and that all the doors and the rear hatch are locked.



Safe driving techniques

- Move the driver's seat as far backward as possible, while still keeping good visibility, and good control of the steering wheel, brakes, accelerator, and controls. Check the instrument panel indicators for any possible problem.
- Move the front passenger seat as far back as possible.
- Make sure that infants and small children are properly restrained in accordance with all laws and regulations.

Defrosters

Check these by selecting the defroster mode, and set the blower switch on high. You should be able to feel the air blowing against the windshield.

(Refer to "Defrosting or defogging the windshield and door windows" on page 7-9.)

Tires

Check all the tires for heavy tread wear or uneven wear patterns. Look for stones, nails, glass, or other objects stuck in the tread. Look for any tread cuts or sidewall cracks. Check the wheel nuts for tightness, and the tires for proper pressures. Replace your tires before they are heavily worn out.

As your vehicle is equipped with a tire pressure monitoring system, there is a risk of damage to the tire inflation pressure sensors when the tire is replaced on the rim. Tire replacement should, therefore, be performed only by a certified i-MiEV dealer.

Lights

Have someone watch while you turn all the exterior lights on and off. Also check the turn signal indicators and high-beam indicators on the instrument panel.

Fluid leaks

Check the ground under the vehicle after parking overnight, for water, oil, or other leaks. Make sure all the fluid levels are correct.

Safe driving techniques

N00629200124

Even this vehicle's safety equipment, and your safest driving, cannot guarantee that you can avoid an accident or injury. However, if you give extra attention to the following areas, you can better protect yourself and your passengers:

- Drive defensively. Be aware of traffic, road and weather conditions. Leave plenty of stopping distance between your vehicle and the vehicle ahead.
- Before changing lanes, check your mirrors and use your turn signal light.
- While driving, watch the behavior of other drivers, bicyclists, and pedestrians.
- Always obey applicable laws and regulations. Be a polite and alert driver. Always leave room for unexpected events, such as sudden braking.

Driving during cold weather

N00629400416

- Check the 12V starter battery, including terminals and cables. During extremely cold weather, the 12V starter battery will not be as strong and its power level may drop. Before driving the vehicle, check to see if the headlights are as bright as normal. Charge or replace the 12V starter battery if necessary. During extreme cold weather, it is possible that a very low 12V starter battery could freeze.

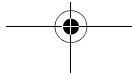

⚠ WARNING

- **The 12V starter battery gives off explosive hydrogen gas. Any spark or flame can cause the 12V starter battery to explode, which could cause serious injury or death. Always wear protective clothes and a face mask when working with your 12V starter battery, or let a skilled mechanic do it.**

- Check the antifreeze.

If there is not enough coolant because of a leak, add high-quality ethylene glycol antifreeze and water. Use Mitsubishi Motors Genuine Super Long Life Coolant Premium or an equivalent. The recommended blend is about 50 % water and 50 % anti-freeze. Use a higher concentration (not over 60 %) when the outside temperature is -31 °F (-35 °C) or lower. When the electric motor unit is working very hard (for example, during mountain driving and/or when the outside temperature is high), use a 50 % concentration. This blend will provide adequate protection from corrosion and boiling.

⚠ WARNING

- **Never open the coolant reservoir cap while it is hot. You could be seriously burned.**

Braking

N00629501531

All the parts of the brake system are critical to safety. Have the vehicle serviced by a certified i-MiEV dealer at regular intervals according to the “WARRANTY AND MAINTENANCE MANUAL”.

When brakes are wet

Check the brake system while driving at a low speed immediately after starting, especially when the brakes are wet, to confirm they work normally.

A film of water can be formed on the brake discs and prevent normal braking after driving in heavy rain or through large puddles, or after the vehicle is washed. If this occurs, dry the brakes out by driving slowly while lightly depressing the brake pedal.

When driving in cold weather

On snowy roads, ice can form on the braking system, making the brakes less effective. While driving in such conditions, pay close attention to preceding and following vehicles and to the condition of the road surface. From time to time, lightly depress the brake pedal and check how effective the brakes are.

When driving downhill

Put the selector lever to “B” (REGENERATIVE BRAKE MODE) or “ECO” (ECO MODE) position according to the grade of the slope and vehicle speed. This will allow effective use of the regenerative brake and prevent the service brake from overheating. If the brake pedal is continuously or frequently depressed on downhill roads, the service brake could overheat and the brake performance will be reduced.

6**NOTE**

- When the main drive lithium-ion battery level is full or nearly full, or the main drive lithium-ion battery temperature is too high or too low, the regenerative braking force may be reduced. Refer to “Regenerative braking” on page 3-3.
- If the red needle in the energy usage indicator does not move to the left of the neutral point (A) while the accelerator pedal is released, the regenerative brake will not work. Refer to “Energy usage indicator” on page 5-37. In the such case, before approaching a long downhill road, reduce speed to prevent the service brake from overheating.

Parking

6

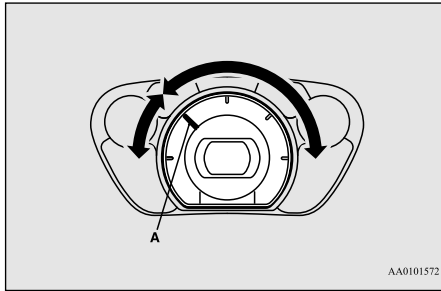

NOTE

- On a slope, be sure to apply the parking brake before moving the selector lever to the “P” (PARK) position. If you move the selector lever to the “P” (PARK) position before applying the parking brake, it may be difficult to disengage the selector lever from the “P” (PARK) position when next you drive the vehicle, requiring application of a strong force to the selector lever to move from the “P” (PARK) position.

slopes where your bumper can scrape the road.

When leaving the vehicle

Always remove the key from the electric motor switch and lock all doors and the liftgate when leaving the vehicle unattended. Always try to park your vehicle in a well lit area.

Parking

N00629600317

Parking on a hill

When parking on a hill, set the parking brake, and turn the front wheels toward the curb on a downhill, or away from the curb on an uphill. If necessary, apply chocks to wheels.

Parking with the electric motor unit running

Never leave the electric motor unit running while you take a short sleep/rest.

WARNING

- Leaving the electric motor unit running when you are not alert risks injury or death from accidentally moving the selector lever.

Do not keep the steering wheel fully turned for a long time

More effort could be required to turn the steering wheel. Refer to “Electric power steering system (EPS)” on page 5-27.

Loading information

N00629900411

It is very important to know how much weight your vehicle can carry. This weight is called the vehicle capacity weight and includes the weight of all occupants, cargo and non-factory-installed options. The tire and loading information placard located on the driver’s door sill of your vehicle will show how much weight it may properly carry.

Where you park

Your front bumper can be damaged if you scrape it over curbs or parking stop blocks. Be careful when traveling up or down steep

⚠ WARNING

● **Never overload your vehicle. Overloading can damage your vehicle, adversely affect vehicle performance, including handling and braking, cause tire failure, and result in an accident.**

It is important to familiarize yourself with the following terms before loading your vehicle:

- Vehicle maximum load on the tire: load on an individual tire that is determined by distributing to each axle its share of the maximum loaded vehicle weight and dividing by two.
- Vehicle normal load on the tire: load on an individual tire that is determined by distributing to each axle its share of the curb weight, accessory weight, and normal occupant weight and dividing by two.
- Maximum loaded vehicle weight: the sum of -
 - (a) Curb weight;
 - (b) Accessory weight;
 - (c) Vehicle capacity weight; and
 - (d) Production options weight.
- Curb weight: the weight of a motor vehicle with standard equipment including the maximum capacity of oil, and coolant.

- Accessory weight: the combined weight (in excess of those standard items which may be replaced) of automatic transmission, power steering, power brakes, power windows, power seats, radio, and heater, to the extent that these items are available as factory- installed equipment (whether installed or not).
 - Vehicle capacity weight: the rated cargo and luggage load plus 150 lbs (68 kg)* times the vehicle's designated seating capacity.
 - Production options weight: the combined weight of those installed regular production options weighing over 5 lbs (2.3 kg) in excess of those standard items which they replace, not previously considered in curb weight or accessory weight, including heavy duty brakes, ride levelers, roof rack, heavy duty battery, and special trim.
 - Normal occupant weight: 150 lbs (68 kg)* times the number of specified occupants. (In your vehicle the number is 2)
 - Occupant distribution: distribution of occupants in a vehicle as specified. (In your vehicle the distribution is 2 in front seat)
- *: 150 lbs (68 kg) is the weight of one person as defined by U.S.A. and Canadian regulations.

Loading information

Tire and loading information placard

N00630100370

The tire and loading information placard is located on the driver's door sill.

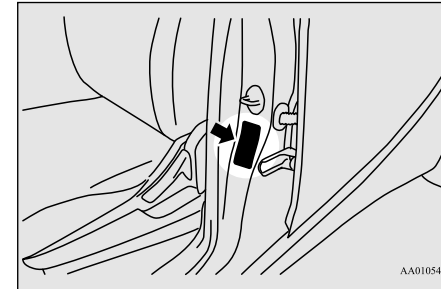

This placard shows the maximum number of occupants permitted to ride in your vehicle as well as “the combined weight of occupants and cargo” (C), which is called the vehicle capacity weight. This placard also tells you the size and recommended inflation pressure for the original equipment tires on your vehicle. For more information, refer to “Tires” on page 9-10.

Loading information

6

EXAMPLE

TIRE AND LOADING INFORMATION RENSEIGNEMENTS SUR LES PNEUS ET LE CHARGEMENT			
SEATING CAPACITY NOMBRE DE PLACES		TOTAL	FRONT AVANT
			REAR ARRIERE
The combined weight of occupants and cargo should never exceed XXX kg or lbs. Le poids total des occupants et du chargement ne doit jamais dépasser XXX kg ou lbs.			
TIRE PNEU	SIZE DIMENSIONS	COLD TIRE PRESSURE PRESSION DES PNEUS A FROID	SEE OWNER'S MANUAL FOR ADDITIONAL INFORMATION VOIR LE MANUEL DE L'USAGER POUR PLUS DE RENSEIGNEMENTS
FRONT AVANT		kPa psi	
REAR ARRIERE		kPa psi	
SPARE DE SECOURS	NONE AUCUN	NONE AUCUN	

AA0105479

Steps for Determining Correct Load Limit

N00630201264

1. Locate the statement "The combined weight of occupants and cargo should never exceed XXX kg or XXX lbs." on your vehicle's placard.
2. Determine the combined weight of the driver and passengers that will be riding in your vehicle.
3. Subtract the combined weight of the driver and passengers from XXX kg or XXX lbs.

4. The resulting figure equals the available amount of cargo and luggage load capacity. For example, if the "XXX" amount equals 1400 lbs. and there will be five 150 lbs. passengers in your vehicle, the amount of available cargo and luggage load capacity is 650 lbs. (1400 - 750 (5 x 150) = 650 lbs.)

5. Determine the combined weight of luggage and cargo being loaded on the vehicle. That weight may not safely exceed the available cargo and luggage load capacity calculated in Step 4.
6. If your vehicle will be towing a trailer, load from your trailer will be transferred to your vehicle. Consult this manual to determine how this reduces the available cargo and luggage load capacity of your vehicle.

NOTE

- The above steps for determining correct load limit were written in accordance with U.S.A. regulations.
- For your vehicle, please determine correct load limit bearing in mind the following differences:
- Your vehicle's seating capacity is 4 people.
 - Your vehicle cannot tow a trailer, so step 6 is irrelevant.

Loading information

NOTE

- The following table shows examples on how to calculate total cargo/load capacity of your vehicle with varying seating configurations and number and size of occupants. This table is for illustration purposes only and may not be accurate for the seating and load capacity of your vehicle.
- For the following example the combined weight of occupants and cargo should never exceed 865 lbs (392 kg).

Occupants			Combined weight of occupants and cargo from Tire Placard	MINUS	Combined Occupant's weight	=	AVAILABLE Cargo/Luggage Weight
TOTAL	FRONT	REAR					
EXAMPLE 1							
4	2	2	865 lbs (392 kg)	minus	Occupant 1: 200 lbs (91 kg) Occupant 2: 130 lbs (59 kg) Occupant 3: 160 lbs (73 kg) Occupant 4: 100 lbs (45 kg) TOTAL WEIGHT: 590 lbs (268 kg)	=	275 lbs (124 kg)
					590 lbs (268 kg)		
EXAMPLE 2							
3	2	1	865 lbs (392 kg)	minus	Occupant 1: 210 lbs (95 kg) Occupant 2: 180 lbs (82 kg) Occupant 3: 150 lbs (68 kg) TOTAL WEIGHT: 540 lbs (245 kg)	=	325 lbs (147 kg)
					540 lbs (245 kg)		
EXAMPLE 3							
2	2	0	865 lbs (392 kg)	minus	Occupant 1: 200 lbs (91 kg) Occupant 2: 200 lbs (91 kg) TOTAL WEIGHT: 400 lbs (182 kg)	=	465 lbs (210 kg)
					400 lbs (182 kg)		

AJM101585

- Under a maximum loaded vehicle condition, gross axle weight ratings (GAWR's) for the front and rear axles must not be exceeded. For further information on GAWR's, vehicle loading, see the "Specifications" section of this manual.

Cargo loads

Cargo loads

N00629700510

Cargo load precautions

To determine the cargo load capacity for your vehicle, subtract the weight of all vehicle occupants from the vehicle capacity weight.

6

For added information, if needed, refer to “Steps for Determining Correct Load Limit” on page 6-8.

DO NOT USE the Gross Vehicle Weight Rating and Gross Axle Weight Rating numbers listed on the safety certification label located on the driver’s side door pillar as the guide for passengers and/or cargo weight.

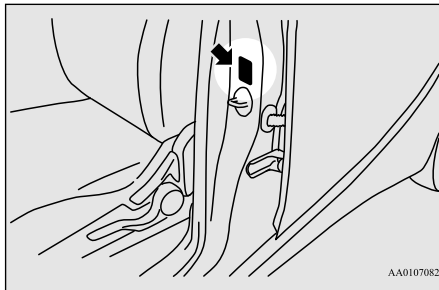

AA0107082

⚠ WARNING

- To reduce the risk of serious injury or death, the combined weights of the driver, passengers and cargo and must never exceed the vehicle capacity weight.
- Exceeding the vehicle capacity weight will adversely affect vehicle performance, including handling and braking, and may cause an accident.
- Do not load cargo or luggage higher than the top of the seatback. Be sure that your cargo or luggage cannot move when your vehicle is in motion.
Having either the rear view blocked, or your cargo being thrown inside the cabin if you suddenly have to brake can cause a serious accident or injury or death.
- Put cargo or luggage in the cargo area of your vehicle. Try to spread the weight evenly.

Trailer towing

N00629800188

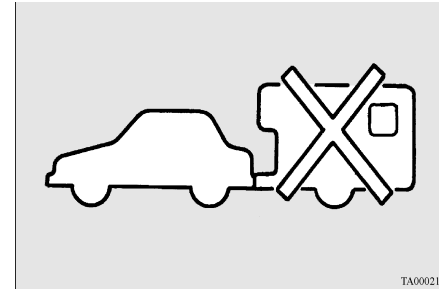

TA0002160

⚠ WARNING

- Do not use this vehicle for trailer towing. It may not be possible to maintain control or adequate braking.

Dinghy towing

N00630700015

Dinghy towing is towing the vehicle with all four wheels on the ground.

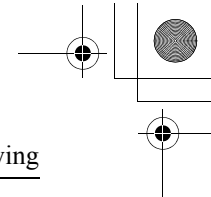
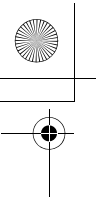

Dinghy towing

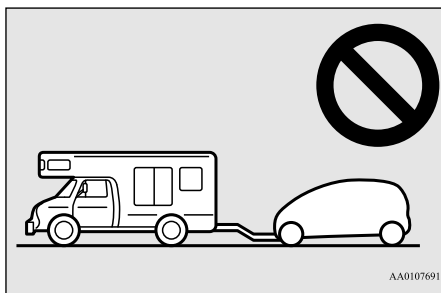

⚠ CAUTION

- Your vehicle is not designed to be dinghy towed behind a motor home.
- Dinghy towing can cause damage to the electric motor unit. Damage caused by dinghy towing will not be covered by the vehicle warranty.

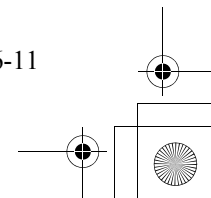
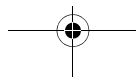
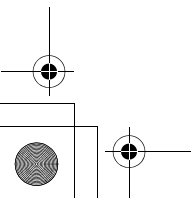
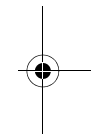
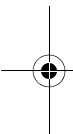

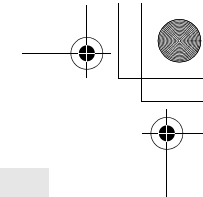
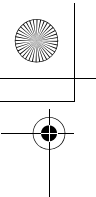

Comfort controls

- Vents7-2
- Air conditioning7-4
- Important air conditioning operating tips7-10
- Air purifier7-11
- Remote Climate Control7-11
- AM/FM electronically tuned radio with CD player
(if so equipped)7-11
- To play iPod/USB memory device tracks via voice operation
(vehicles with Bluetooth® 2.0 interface)7-20
- Steering wheel audio remote control switch (if so equipped)7-22
- Error codes7-24
- Handling of compact discs7-25
- Antenna7-27
- Clock (if so equipped)7-27
- General information about your radio7-28

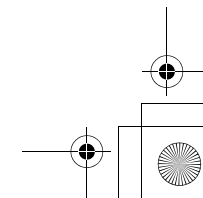
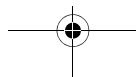
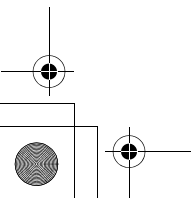
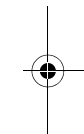
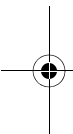

Vents

Vents

N00729900265

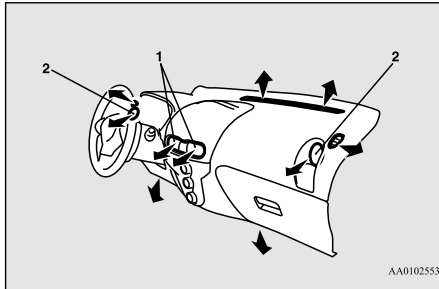

7

- 1- Center vents
- 2- Side vents

NOTE

- Do not place beverages on top of the instrument panel. If they splash into the air conditioning vents, they could damage the system.

Air flow and direction adjustments

N00730200314

Center vents

Adjust the direction of the air flow by moving the knob (A) and vent.

7-2 Comfort controls

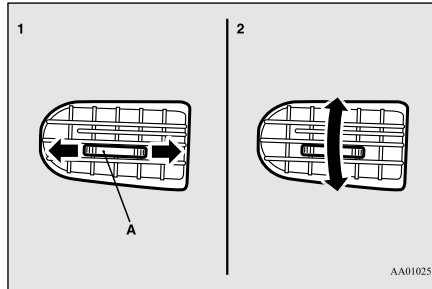

- 1- Left-right adjustment
- 2- Up-down adjustment

Side vents

When the dimple (A) is pressed, the vent opens.
To close the vent, press the dimple (B) on the opposite side.

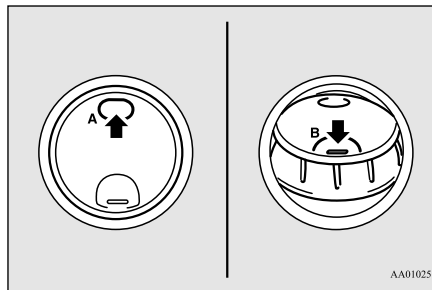

NOTE

- On rare occasions, air from the vents of an air-conditioned vehicle may be foggy. This is only moist air cooling suddenly and does not indicate a problem.
- Do not let drinks or other liquids get into the vents as they could prevent the air conditioning from operating normally.

Changing the mode selection

N00736400581

To change the position and amount of air flowing from the vents, turn the mode selection dial. Refer to “Mode selection dial” on page 7-5.

These symbols are used in the next several illustrations to demonstrate the quantity of air coming from the vents.

- : Small amount of air from the vents
- ↔: Large amount of air from the vents

Vents

Face position

Air flows only to the upper part of the passenger compartment.

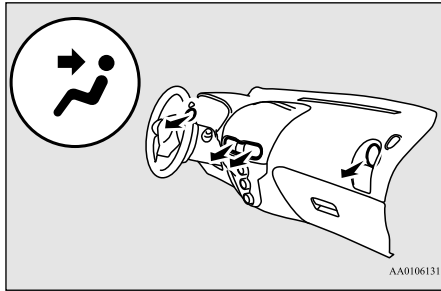

NOTE

- With the mode selection dial between the “” and “” positions, air flows mainly to the upper part of the passenger compartment. With the mode selection dial between the “” and “” positions, air flows mainly to the leg area.

Foot position

Air flows mainly to the leg area.

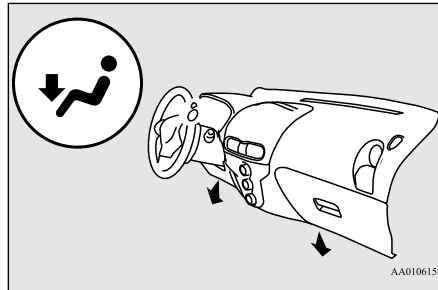

Foot/Defroster position

Air flows to the leg area, the windshield and the door windows.

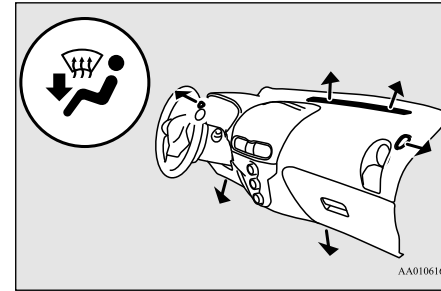

7

Foot/Face position

Air flows to the upper part of the passenger compartment, and flows to the leg area.

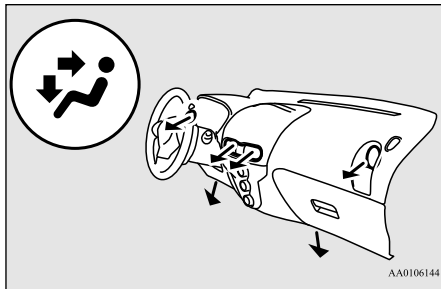

NOTE

- With the mode selection dial between the “” and “” positions, air flows mainly to the leg area. With the mode selection dial between the “” and “” positions, air flows mainly to the windshield and door windows.

Air conditioning

Defroster position

Air flows mainly to the windshield and the door windows.

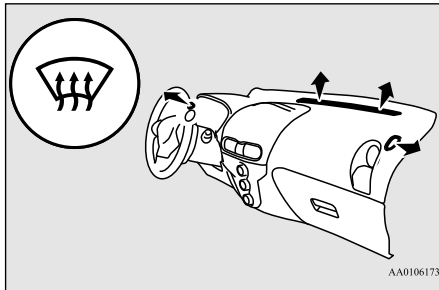

7

Control panel

N00730501314

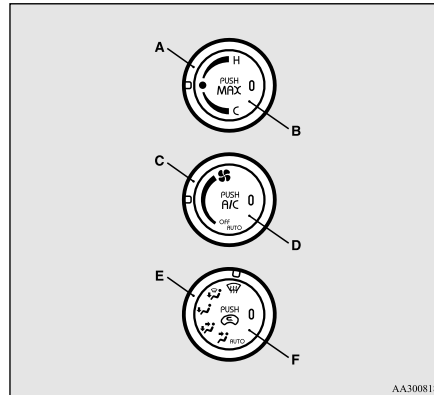

- A- Temperature control dial
- B- MAX switch
- C- Blower speed selection dial
- D- Air conditioning switch
- E- Mode selection dial
- F- Air selection switch

Air conditioning

N00730300328

The air conditioning can only be used when the ready indicator is illuminated.

NOTE

- If the energy level gauge is at 0 bars or the power down warning light illuminates, the vehicle interior may not be cooled/heated even though the dial or switch is operated. Furthermore, the defog performance may be also reduced.
Refer to “Energy level gauge” on page 5-41.
Refer to “Power down warning light” on page 5-46.

NOTE

- There is an interior air temperature sensor (G) in the illustrated position. Never place anything over the sensor, since doing so will prevent it from functioning properly.

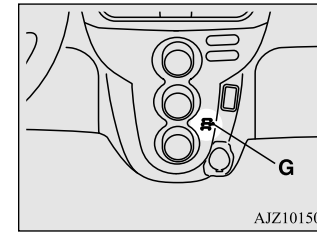

Blower speed selection dial

N00736500191

When the electric motor switch is in the “ON” position, select the blower speed by turning the blower speed selection dial. Turning the dial clockwise will increase the blower speed; turning the dial counterclockwise will decrease it. When the dial is set to the “OFF” position, all fan-driven airflow will stop. When the dial is set to the “AUTO” position, the air flow is adjusted automatically according to the temperature of the interior and the position of the temperature control dial.

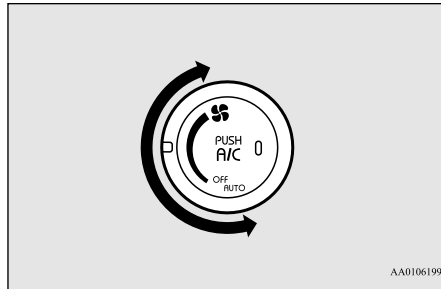

Temperature control dial

N00736600235

Use this dial to adjust the temperature of the air flow from the vents. Turn the temperature control dial clockwise to make the air warmer. Turn it counterclockwise to make the air cooler. When the dial is set to middle (●) position, only uncooled and unheated air will flow. When the dial is moved to middle (●) position when using cooling or heating, cooling or heating stops.

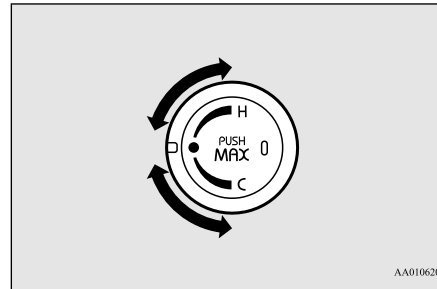

NOTE

- When the dial is moved from middle (●) position to the left while the air conditioning is not operating, the air temperature will not change.

NOTE

- When the dial is moved to middle (●) position and then to the left while the air conditioning is operating, the air conditioning system is operating again.
- When the temperature control dial is set to “C” position, the air selection will be automatically set to the recirculation position and the air conditioning will operate. When the dial is moved thereafter, the air conditioning continues to operate and the air selection setting returns to the setting before the dial was set to “C” position.

7

Mode selection dial

N00736700210

To change the position and amount of air flowing from the vents, turn the mode selection dial. Refer to “Changing the mode selection” on page 7-2.

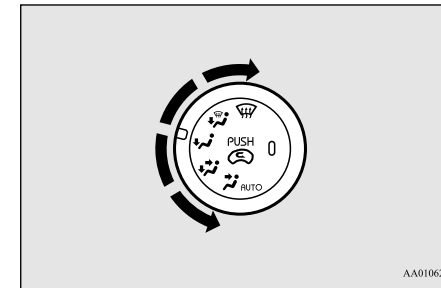

Air conditioning

“AUTO” position

The vents change to the following positions according to the position of the temperature control dial.

Refer to “Temperature control dial” on page 7-5.

7

Temperature control dial position		Vents
Between “C” and middle (●)		: Upper part of front passenger compartment
Middle (●)	Set the dial to middle (●) from the “C” side	: Upper part of front passenger compartment
	Set the dial to middle (●) from the “H” side	: Leg area
Between middle (●) and “H”	Near middle (●)	: Leg area
	Near “H”	: Leg area, windshield, and door windows

CAUTION

- When using the mode selection dial between the “” and “” positions, prevent fogging by pressing the air selection switch to select outside air. (Refer to “Air selection switch” on page 7-6.)

Air selection switch

N00736800400

Normally, use the outside air position to keep the windshield and side windows clear and to quickly remove fog or frost from the windshield.

To change the air selection, simply press the air selection switch.

- Outside air {Indicator light (A) OFF}
Outside air is introduced into the passenger compartment.
- Recirculated air {Indicator light (A) ON}
Air is recirculated inside the passenger compartment.

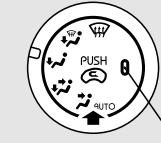

AA0106229

If high cooling performance is desired, or, if the outside air is dusty or contaminated in some way, use the recirculation position. Switch to the outside air position every now and then to keep the windows from fogging up.

CAUTION

- Using recirculated air for a long time may cause the windows to fog up.

NOTE

- When the mode selection dial is set to the “” position, the air conditioning compressor runs automatically. Outside air introduction will also be selected automatically.
- When the temperature control dial is set to the “C” position, the air selection will be automatically set to the recirculation position.

Air conditioning

Air conditioning switch

N00731000465

Push the switch, and the air conditioning compressor will turn on. The air conditioning indicator light (A) will come on.

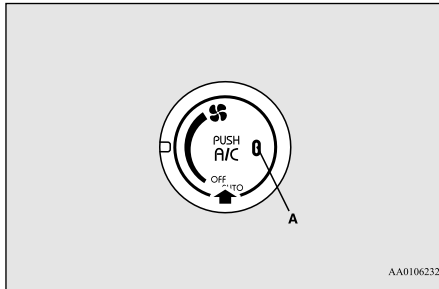

Push the switch again and the air conditioning compressor will stop and the indicator light (A) goes off.

MAX switch

N00766500015

When the blower speed selection dial is not OFF and the MAX switch is pressed, the indicator light (A) illuminates and cooling/heating performance and the air conditioning setting is changed according to the temperature control dial position.

When the switch is pressed again, the operation returns to the mode before pressing the switch.

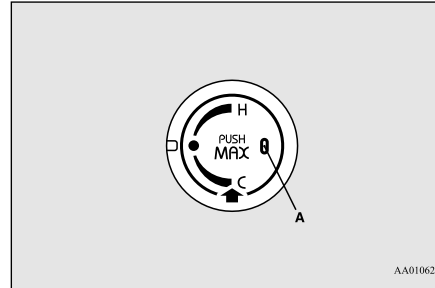

When the temperature control dial is set between middle (●) and “H” position

The heating capability is at maximum.

When the temperature control dial is in middle (●) position

The air flow is at maximum.

When the temperature control dial is set between “C” and middle (●) position

The air conditioning automatically operates and the cooling capability is at maximum.

NOTE

- Do not use the cooling/heating function with the MAX switch for a long time. Because the power consumption is greatly increased, the cruising range is shortened.

NOTE

- When the blower speed selection dial or temperature control dial is operated with the indicator light illuminated, the indicator light goes out and the selected function overrides others. Other functions return to the mode before pressing the MAX switch.
- When the air conditioning is operated with the MAX switch, the air conditioning does not stop if the function is cancelled.

Operating the air conditioning system

N00731101290

Heating

- Set the mode selection dial to the “” position.
- Set the air selection switch (A) to the outside position.
- Turn the temperature control dial clockwise or counterclockwise to the desired temperature between middle (●) and “H” position.
- Select the desired blower speed.

Air conditioning

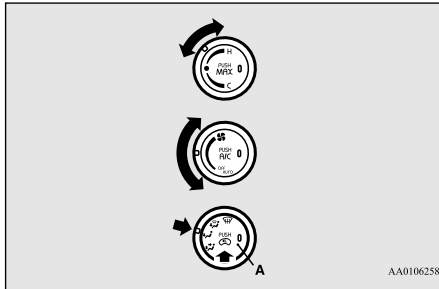

AA0106258

7

NOTE

- When the blower speed selection dial is set to the "AUTO" position, the air flow is adjusted automatically according to the temperature of the interior and the position of the temperature control dial.

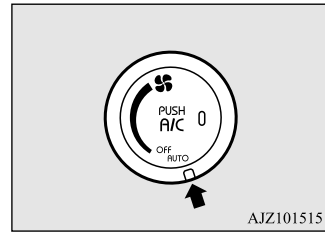

AJZ101515

- Set the air selection switch (A) to the outside position.
- Turn the temperature control dial clockwise or counterclockwise to between middle (●) position and "H" position.
- Turn the blower speed selection dial to any position other than "OFF" position.
- Press the MAX switch (B).

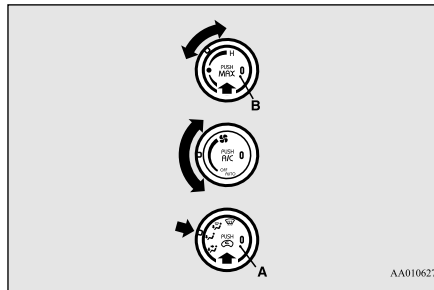

AA0106274

NOTE

- Do not use the heating function with the MAX switch for a long time. Because the power consumption is greatly increased, the cruising range is shortened.

Cooling

N00731201363

For ordinary cooling

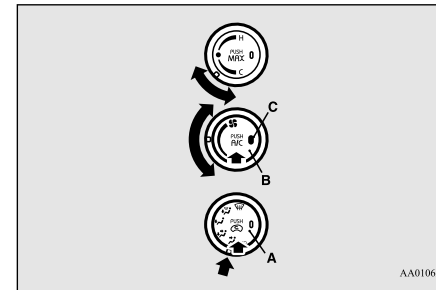

AA0106287

- Set the mode selection dial to the "C" position.
- Set the air selection switch (A) to the outside position.
- Turn the temperature control dial clockwise or counterclockwise to the desired temperature between middle (●) and "C" position.
- Select the desired blower speed.
- Push the air conditioning switch (B).
- When the air conditioning is operating, the switch indicator light (C) illuminates.

Quick heating

- Set the mode selection dial to the "C" position.

7-8 Comfort controls

NOTE

- If the outside air is dusty or contaminated in some way, set the air selection switch (A) to the recirculation position. Let in some outside air from time to time for good ventilation.
- To cool the leg areas, set the mode selection dial to the “” position.
- When the blower speed selection dial is set to the “AUTO” position, the air flow is adjusted automatically according to the temperature of the interior and the position of the temperature control dial.

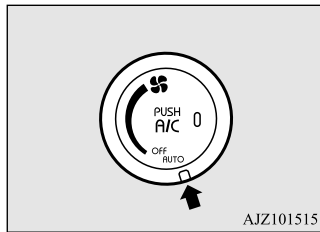

For quick cooling

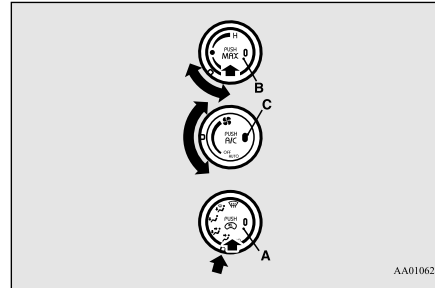

1. Set the mode selection dial to the “” position.
2. Set the air selection switch (A) to the recirculation position.
3. Turn the temperature control dial clockwise or counterclockwise to between middle (●) and “C” position.
4. Turn the blower speed selection dial to any position other than “OFF” position.
5. Press the MAX switch (B).

The air conditioning automatically operates and the indicator light (C) illuminates.

NOTE

- Do not use the cooling function with the MAX switch for a long time. Because the power consumption is greatly increased, the cruising range is shortened.

Defrosting or defogging (windshield, door windows)

N00731400557

CAUTION

- For safety, make sure you have a clear view through all the windows.

To remove frost or fog from the windshield and door windows, use the mode selection dial (“” or “”).

7

For ordinary defrosting

Use this setting to keep the windshield and door windows clear of mist, and to keep the leg area heated (when driving in rain or snow).

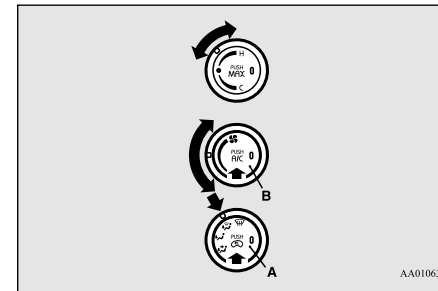

1. Set the air selection switch (A) to the outside position.

Important air conditioning operating tips

2. Set the mode selection dial to the “” position.
3. Turn the temperature control dial clockwise or counterclockwise to the desired temperature between middle (●) and “H” position.
4. Select the desired blower speed.
5. Push the air conditioning switch (B).

For quick defrosting

7

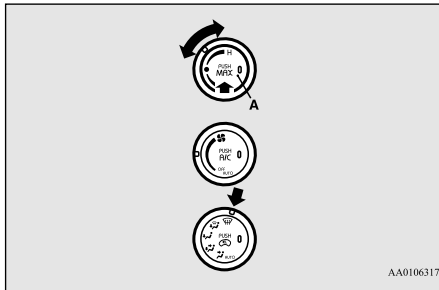

1. Set the mode selection dial to the “” position.
2. Turn the temperature control dial clockwise or counterclockwise to the desired temperature between middle (●) and “H” position.
3. Press the MAX switch (A).

NOTE

- When the mode selection dial is set to the “” position, the air conditioning compressor runs automatically. Outside air introduction will also be selected automatically.
- When defrosting, do not set the temperature control dial to the maximum cool position. This would blow cool air on the window glass and fog it up.
- Since defogging or defrosting with the MAX switch consumes a large amount of power, stop the switch after defogging or defrosting. Use the MAX setting for a long time decreases the cruising range.

Important air conditioning operating tips

N00733700323

1. Park the vehicle in the shade whenever possible. Parking in the hot sun makes the vehicle interior extremely hot which then requires more time to cool. If it is necessary to park in the sun, open the windows for the first few minutes of air conditioning to expel the hot air.
2. Afterwards, keep the windows closed when the air conditioning is in use. The entry of outside air through open windows will reduce cooling efficiency.

3. When running the air conditioning, make sure the air intake, which is located in front of the windshield, is free of obstructions such as leaves. Leaves collected in the air-intake chamber may reduce air flow and plug the water drains.

Air conditioning system refrigerant and lubricant recommendations

If the air conditioning seems less effective than usual, the cause might be a refrigerant leak.

Have the system inspected by a certified i-MiEV dealer.

CAUTION

- The air conditioning system in your vehicle must be charged with the refrigerant HFC-134a and the lubricant POE MA68EV. Use of any other refrigerant or lubricant will cause severe damage and may require replacing your vehicle's entire air conditioning system. The release of refrigerant into the atmosphere is not recommended. The new refrigerant HFC-134a in your vehicle is designed not to harm the earth's ozone layer. However, it may contribute slightly to global warming. It is recommended that the old refrigerant be saved and recycled for future use.

During a long period of disuse

The air conditioning should be operated for at least five minutes each week, even in cold weather. This includes the quick defrosting mode. Operating the air condition system weekly maintains lubrication of the compressor internal parts and maintains the air conditioning in the best operating condition.

Air purifier

N00733800177

The air conditioning system is equipped with an air filter to reduce pollen and dust entering the cabin.

The air filter's ability to collect pollen and dust will be reduced as it becomes dirty, so replace it periodically. For the maintenance interval, refer to the "WARRANTY AND MAINTENANCE MANUAL".

NOTE

- Operation in certain conditions such as driving on a dusty road or frequent use of the air conditioning can reduce the service life of the filter. When you feel that the air flow is lower than normal or when the windshield or windows start to fog up easily, replace the air filter. Contact a certified i-MiEV dealer for assistance.

Remote Climate Control

N00766601026

You can run the air conditioning in advance of using the vehicle. For details, refer to "Remote Climate Control" on page 3-36, 3-47.

AM/FM electronically tuned radio with CD player (if so equipped)

N00734301062

The audio system can only be used when the electric motor switch is in the "ON" or "ACC" position.

NOTE

- To listen to the audio system while the electric motor unit is not running, turn the electric motor switch to the "ACC" position. If the electric motor switch is in the "ACC" position, the accessory power will automatically turn off after a certain period of time and you will no longer be able to use the audio system. The accessory power comes on again if the electric motor switch is turned from the "ACC" position. Refer to "ACC power auto-cutout function" on page 5-19.
- If a cellular phone is used inside the vehicle, it may create noise in the audio equipment. This does not mean that anything is wrong with your audio equipment. In such a case, use the cellular phone at a place as far away as possible from the audio equipment.

7

AM/FM electronically tuned radio with CD player (if so equipped)

NOTE

- If foreign objects or water get into the audio equipment, or if smoke or a strange odor comes from it, immediately turn off the audio system and have it checked at a certified i-MiEV dealer. Never try to repair it yourself. Avoid using the audio system until it is inspected by a qualified person.
- If the audio system is damaged by foreign objects, water, or fire, have the system checked at a certified i-MiEV dealer.

7

Volume and tone control panel

N00711900716

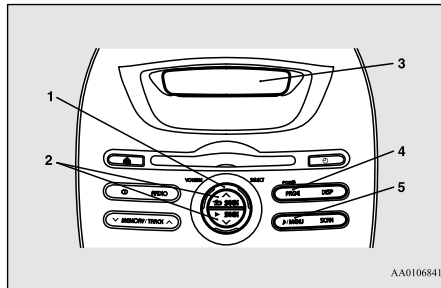

- 1- VOLUME (Volume control) knob
- 2- SEEK (Audio adjust) button
- 3- Display
- 4- POWER (On-Off) button
- 5-  (Mode change) button

To adjust the volume

N00712000408

Turn the VOLUME knob clockwise to increase the volume; counterclockwise to decrease the volume.
The status will be displayed in the display.

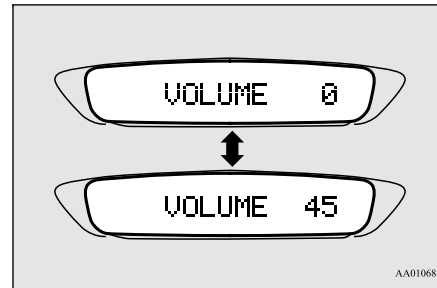

NOTE

- The volume control mode will shut off automatically if the another mode is selected, or if no adjustment is made within about 2 seconds.

To adjust the tone

N00712100672

1. Press the  button repeatedly to select the tone, balance and SCV (Speed Compensated Volume) function control to change. The order is: BASS → TREBLE → FADER → BALANCE → SCV → Audio adjust mode OFF
2. Press the SEEK button to change the tone, balance and SCV function setting.
The status will be displayed in the display.

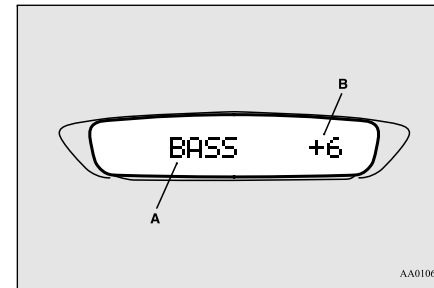

- A- Adjust mode
B- Adjust level

AM/FM electronically tuned radio with CD player (if so equipped)

Adjust Mode	Adjust Level	SEEK button operation	
		Λ	V
BASS	-6 to 6	Stronger	Weaker
TREBLE		Stronger	Weaker
FADER	F11 to R11	F (Front) increases	R (Rear) increases
BALANCE	L11 to R11	R (Right) increases	L (Left) increases
SCV	HIGH, MID, LOW, OFF	HIGH ↑ MID ↑ LOW ↑ OFF	HIGH ↓ MID ↓ LOW ↓ OFF

BASS (Bass tone control)

To select the desired bass level.

TREBLE (Treble tone control)

To select the desired treble level.

FADER (Front/Rear balance control)

To balance the volume from the F (front) and the R (rear) speakers.

BALANCE (Left/Right balance control)

To balance the volume from the L (left) and the R (right) speakers.

SCV (Speed Compensated Volume) function

Speed Compensated Volume function is a feature that automatically adjusts the VOLUME, BASS and TREBLE settings in accordance with the vehicle speed.

The effects of the SCV function can be selected either of three levels (LOW, MID and HIGH). Select the degree of your choice by pressing the SEEK button.

If you want to stop the SCV function, select the OFF.

NOTE

- The audio adjust mode will automatically shut off when another mode is selected, or if no adjustment is made within about 10 seconds.

Radio control panel and display

N00734900902

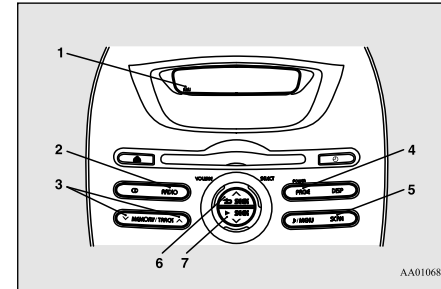

7

- 1- FM (FM1/FM2) indicator
- 2- RADIO (AM/FM selection) button
- 3- MEMORY (Memory selection) button
- 4- POWER (On-Off) button
- 5- SCAN button
- 6- SEEK (Up-seek) button
- 7- SEEK (Down-seek) button

AM/FM electronically tuned radio with CD player (if so equipped)

To listen to the radio

N00735000913

1. Press the POWER button until it beeps to turn the audio system ON and OFF. The system turns on in the last mode used. Press the RADIO button to turn ON the radio.
2. Press the RADIO button to select the desired band (AM/FM1/FM2).
3. Press the SEEK button to tune to a station, or press the MEMORY button either **▲** or **▼** to tune in to a station memorized. Refer to “Automatic tuning”, “Manual tuning” or “To enter frequencies into the memory”.

7

Automatic tuning

After pressing the SEEK button, a receivable station will be automatically selected and reception of the station will begin.

SCAN function

Press the SCAN button. The radio will tune consecutively to each available station for about 5 seconds per station. If you want to stop scanning, press the SCAN button again. The frequency display of the current station flashes once per second during SCAN.

Manual tuning

The frequency changes every time the SEEK button is pressed. Press the button to select the desired station.

To enter frequencies into the memory

As many as 6 AM and 12 FM stations can be entered into the memory.

To store a frequency in the memory, follow these steps:

1. Press the SEEK button to tune to the frequency you wish to keep in the memory.
2. Press the MEMORY button either **▲** or **▼** until it beeps.

The sound will be momentarily interrupted while the frequency is being entered into the memory.

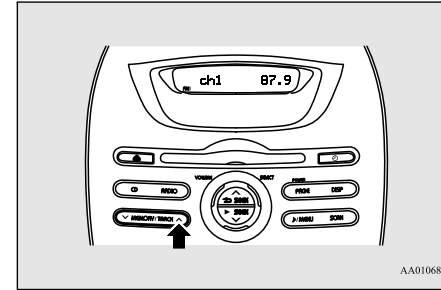

3. To recall a frequency that has been saved in memory, press the MEMORY button briefly for no longer than about 1 second.

NOTE

- Disconnecting the 12V starter battery cables erases all the radio station settings stored in the memory.

AM/FM electronically tuned radio with CD player (if so equipped)

CD control panel and display

N00735300743

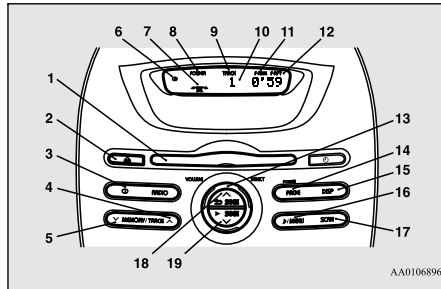

- 1- Disc loading slot
- 2- Eject button
- 3- CD (CD mode changeover) button
- 4- TRACK ▲ (Fast-forward/Track up) button
- 5- TRACK ▼ (Fast-reverse/Track down) button
- 6- CD indicator
- 7- SEL (Select mode) indicator
- 8- FOLDER indicator
- 9- TRACK indicator
- 10- Display
- 11- RDM/F-RDM indicator
- 12- RPT/F-RPT indicator
- 13- SELECT knob
- 14- POWER (On-Off) button/PAGE (Title scroll) button
- 15- DISP (Title display) button
- 16- MENU button

- 17- SCAN button
- 18- SEEK ▲ (Up-seek) button/↵ (Return) button
- 19- SEEK ▼ (Down-seek) button/▶ (Select) button

To listen to a CD

N00735502097

To set a disc

1. Press the POWER button until it beeps to turn the audio system ON and OFF. The system turns on in the last mode used.
2. Insert the disc with the label facing up. When a disc is inserted, the CD indicator will come on and the CD player will begin playing even if the radio is being used. The CD player will also begin playing when the CD button is pressed with a disc set in the CD player or in the disc loading slot, even if the radio is being used.

NOTE

- For information concerning the adjustment of volume and tone, refer to “To adjust the volume” on page 7-12 and “To adjust the tone” on page 7-12.
- 3 inches (8 cm) compact disc cannot be played on this CD player.

NOTE

- For information concerning the handling of the compact discs, refer to “Handling of compact discs” on page 7-25.

To eject a disc

When the eject button is pressed, the disc automatically stops and is ejected. The system automatically switches to radio mode.

7

NOTE

- If you do not remove an ejected disc before 15 seconds have elapsed, the disc will be reloaded.

To listen to a music CD

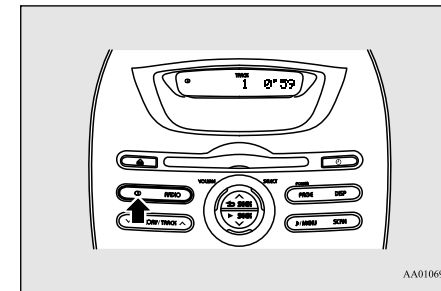

AM/FM electronically tuned radio with CD player (if so equipped)

Push the CD button if a disc is already in the CD player. The audio system will enter CD mode and start playback. The track number and the playing time will appear on the display. The tracks in the disc will be played consecutively and continuously.

Push the CD button if a disc is already in the CD player.

The display shows “READING”, then playback begins. The folder number, the track number and the playing time will appear on the display.

NOTE

- This unit does not record MP3 files.
- For information concerning CD-Rs/RWs, refer to “Notes on CD-Rs/RWs” on page 7-26.

To listen to an MP3 CD

7

This CD player allows you to play MP3 (MPEG Audio Layer-3) files recorded on CD-ROMs, CD-Rs (recordable CDs), and CD-RWs (rewritable CDs) in ISO9660 Level 1/Level 2, Joliet, and Romeo formats. Each disc may have a maximum of 16 trees, 100 folders and 255 files. During MP3 playback, the unit can display ID3 tag information. For information concerning ID3 tag, refer to “CD text and MP3 title display” on page 7-19.

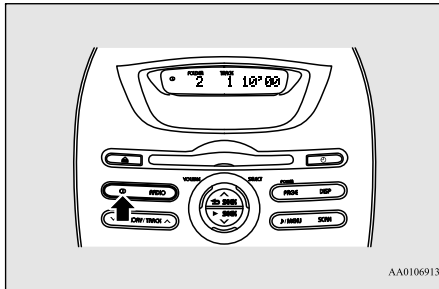

NOTE

- While listening to a disc on which CD-DA (CD-Digital Audio) and MP3 files have both been recorded, you can switch between reading of the CD-DA, reading of the MP3 files, and the external audio input mode by pressing the CD button for 2 seconds or longer (until you hear a beep).
- With a disc that contains both CD-DA and MP3 files, the CD-DA files are automatically played first.
- The playback sound quality differs depending on the encoding software and the bit rate. For details, refer to the user manual of your encoding software.
- Depending on file/folder configurations on a disc, it may take some time before playback starts.
- MP3 encode software and writing software are not supplied with this unit.
- You may encounter trouble in playing an MP3 or displaying the information of MP3 files recorded with certain writing software or CD recorders (CD-R/RW drivers).
- If you record too many folders or files other than MP3 onto a disc, it may take some time before playback starts.

CAUTION

- Attempting to play a file not in the MP3 format which has the “.mp3” file name may produce noise from the speakers and speaker damage, and can damage your hearing.

7-16 Comfort controls

AM/FM electronically tuned radio with CD player (if so equipped)

Folder selection order/MP3 file playback order (Example)

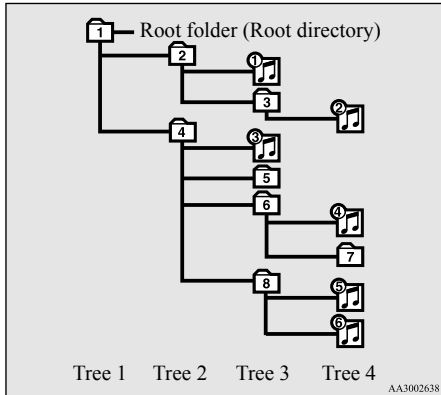

Folder selection

In the order

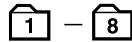

File selection

In the order



To fast forward/reverse the disc

To fast forward or fast reverse the disc, press the TRACK **▲** button or the TRACK **▼** button.

Fast forward

You can fast-forward the disc by pressing the TRACK **▲** button. While the button is kept pressed, the disc will be fast-forwarded.

Fast reverse

You can fast reverse the disc by pressing the TRACK **▼** button. While the button is kept pressed, the disc will be fast-reversed.

To select a desired track

You can select your desired track by using the TRACK button.

Track up

Press the TRACK **▲** button repeatedly until the desired track number appears on the display.

When listening to a MP3 CD, keep pressing the button to continue to move up tracks.

Track down

Press the TRACK **▼** button repeatedly until the desired track number appears on the display.

When listening to a MP3 CD, keep pressing the button to continue to move down tracks.

NOTE

- Pressing the TRACK **▼** button once during the song will cause the CD player to restart playback from the beginning of the song.

To find a file (MP3 CDs only)

Operate the following buttons or the SELECT knob to select desired file.

When this mode is activated by pressing the **↵** button, the SEL indicator will be displayed in the display.

↵ button : Press the button to start this mode or cancel the selection.

SELECT knob : Turn the knob to show the folder or file.

▶ button : Press the button to select the folder or file.

NOTE

- If no operation is performed for 10 seconds or more or other button is operated after the SELECT knob has been turned, searching of the desired file is canceled.
- If no operation is performed for 5 seconds or more after the file is displayed, playback starts.

7

AM/FM electronically tuned radio with CD player (if so equipped)

NOTE

- When the SEL indicator is not shown on the display and the SELECT knob is operated, the volume adjustment is effective.

To select the playing mode

N00771500013

- Press the MENU button until beeps.
- Press the SEEK **▲/▼** button repeatedly to select the mode.

7

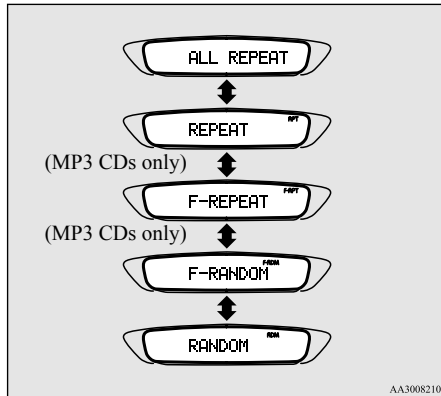

- Press the MENU button until you hear a beep. The selected mode will operate.

To play tracks in repeat

N00771600014

Repeat an all track (normal playback)

Select the ALL REPEAT mode. Refer to “To select the playing mode” on page 7-18. The all tracks on the disc will be played repeatedly.

Repeat a track

Select the REPEAT mode. Refer to “To select the playing mode” on page 7-18. The RPT indicator will come on and repeat the same track.

Repeat tracks in the same folder (MP3 CDs only)

Select the F-REPEAT mode. Refer to “To select the playing mode” on page 7-18. The F-RPT indicator will come on and the all track on the currently selected folder will be played repeatedly.

NOTE

- With a disc that contains both CD-DA and MP3 files, the repeat mode causes only files of the same format (CD-DA only or MP3 files only) to be repeated.

To play tracks in random order

N00771800016

Random playback for a disc (music CDs only)

Select the RANDOM mode. Refer to “To select the playing mode” on page 7-18. The RDM indicator will come on and the tracks on the disc will be played in a random sequence.

Random playback for a folder (MP3 CDs only)

Select the F-RANDOM mode. Refer to “To select the playing mode” on page 7-18. The F-RDM indicator will come on and the tracks on the currently selected folder will be played in a random sequence.

Random playback for all folders on a disc (MP3 CDs only)

Select the RANDOM mode. Refer to “To select the playing mode” on page 7-18. The RDM indicator will come on and the files from all the folders on the disc will be playback in a random sequence.

AM/FM electronically tuned radio with CD player (if so equipped)

 **NOTE**

- With a disc that contains both CD-DA and MP3 files, the random mode causes only files of the same format (CD-DA only or MP3 files only) to be repeated.

To find the start of each track on a disc for playback

N00771900017

Press the SCAN button. “SCAN” will appear on the display and the CD player will play back the first 10 seconds of each track on the selected disc (music CDs only) or the currently selected folder (MP3 CDs only). The track number will blink while the scan mode is selected. To stop the scan mode, press the SCAN button again.

 **NOTE**

- Once all tracks on the disc (music CDs only) or the currently selected folder (MP3 CDs only) have been scanned, playback of the disc will restart from the beginning of the track that was playing when scanning started.
- With a disc that contains both CD-DA and MP3 files, the scan mode causes only files of the same format (CD-DA only or MP3 files only) to be played.

CD text and MP3 title display

N00752100166

This audio system can display CD text and MP3 titles including ID3 tag information.

CD text

The audio system can display disc and track titles for discs with converted disc and track title information. Press the DISP button repeatedly to make selections in the following sequence: disc name → track name → normal display mode.

 **NOTE**

- The display can show up to 11 characters. If a disc name or track name has more than 11 characters, press the PAGE button to view the next 11 characters.
- When there is no title information to be displayed, the display shows “NO TITLE”.
- Characters that the audio system cannot display are shown as “ ”.

MP3 title

The audio system can display folder and track titles for discs with converted folder and track information. Press the DISP button repeatedly to make selections in the following sequence: folder name → track name → normal display mode.

ID3 tag information

The audio system can display ID3 tag information for files that have been recorded with ID3 tag information.

1. Press the DISP button for 2 seconds or longer to switch to the ID3 tag information. “TAG” will appear on the display.
2. Press the DISP button repeatedly to make selections in the following sequence: album name → track name → artist name → normal display mode.

7 **NOTE**

- To return from ID3 tag information to the folder name, press the DISP button again for 2 seconds or longer.
- When there is no title information to be displayed, the display shows “NO TITLE”.
- The display can show up to 11 characters. If a folder name, track name, or item of ID3 tag information has more than 11 characters, press the PAGE button to view the next 11 characters.
- Folder names, track names and ID3 tag information can each be displayed up to a length of 32 characters.
- Characters that the audio system cannot display are shown as “ ”.

To play iPod/USB memory device tracks via voice operation (vehicles with Bluetooth® 2.0 interface)

To play iPod/USB memory device tracks via voice operation (vehicles with Bluetooth® 2.0 interface)

N00772001025

Desired tracks can be selected and played from your iPod or USB memory device by “Artist”, “Album”, “Playlist” and “Genre” using voice commands.

7

For information concerning the voice recognition function or speaker registration function, refer to “Bluetooth® 2.0 interface” on page 5-53.

The following explains how to prepare for voice operation and play the tracks.

Preparation for voice operation

N00772101026

To use the voice operation, press the PICK-UP button (1) first.

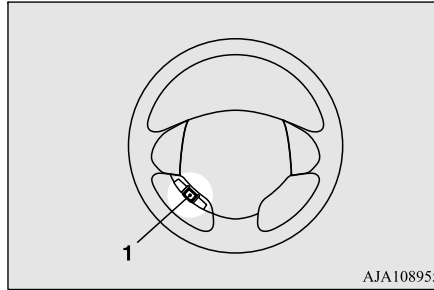

To search by artist name

N00772200017

1. Say “Play” on the main menu.

NOTE

- The Bluetooth® 2.0 interface starts recognizing the connected device. If the connected device cannot be recognized or a connection error occurs, the Bluetooth® 2.0 interface starts an appropriate voice guide. Follow the voice guide.

2. After the voice guide says “Would you like to play by Artist, Album, Playlist or Genre?”, say “Artist”.

NOTE

- If you say “Artist <name>,” you can skip step 3.

3. After the voice guide says “What Artist would you like to play?,” say the artist name.

4. If there is only one match, the system proceeds to step 6.

5. If there are two or more matches, the voice guide will say “More than one match was found, would you like to play <artist name>?” If you say “Yes,” the system proceeds to step 6.

If you say “No,” the next matching artist is uttered by the system.

NOTE

- If you say “No” to three or all artist names uttered by the system, the voice guide will say “Artist not found, please try again” and the system returns to step 2.
- Search time depends on the number of songs on your connected device. Devices containing a large number of songs may take longer to return search results.

6. After the voice guide says “Playing <artist name>,” the system creates a playlist index for the artist.

To play iPod/USB memory device tracks via voice operation (vehicles with Bluetooth® 2.0 interface)

NOTE

- If the confirmation function is active, the voice guide confirms if the artist name is correct. If the artist name is correct, say “Yes”. If not, say “No”. After the voice guide says “Artist not found, please try again,” the system returns to step 2.

7. The system exits the voice recognition mode and starts playback.

To search by album title

N00772300018

1. Say “Play” on the main menu.

NOTE

- The Bluetooth® 2.0 interface starts recognizing the connected device. If the connected device cannot be recognized or a connection error occurs, the Bluetooth® 2.0 interface starts an appropriate voice guide. Follow the voice guide.

2. After the voice guide says “Would you like to play by Artist, Album, Playlist or Genre?,” say “Album”.

NOTE

- If you say “Album <title>,” you can skip step 3.

3. After the voice guide says “What Album would you like to play?” say the album title.
4. If there is only one match, the system proceeds to step 6.
5. If there are two or more matches, the voice guide will say “More than one match was found, would you like to play <album title>?” If you say “Yes,” the system proceeds to step 6. If you say “No,” the name of the next matching album is uttered by the system.

NOTE

- If you say “No” to three or all album titles uttered by the system, the voice guide will say “Album not found, please try again” and the system returns to step 2.

6. After the voice guide says “Playing <album title>,” the system creates a playlist index for the album title.

NOTE

- If the confirmation function is active, the voice guide confirms if the album title is correct. If the album title is correct, say “Yes”. If not, say “No”. After the voice guide says “Album not found, please try again,” the system returns to step 2.

7. The system exits the voice recognition mode and starts playback.

To search by playlist

N00772400019

1. Say “Play” on the main menu.

NOTE

- The Bluetooth® 2.0 interface starts recognizing the connected device. If the connected device cannot be recognized or a connection error occurs, the Bluetooth® 2.0 interface starts an appropriate voice guide. Follow the voice guide.

7

2. After the voice guide says “Would you like to play by Artist, Album, Playlist or Genre?,” say “Playlist”.

NOTE

- If you say “Playlist <playlist>,” you can skip step 3. If the device has no playlist, the voice guide will say “There are no playlists stored on device” and the system returns to step 2.

3. After the voice guide says “What Playlist would you like to play?,” say the playlist name.

4. If there is only one match, the system proceeds to step 6.

Steering wheel audio remote control switch (if so equipped)

5. If there are two or more matches, the voice guide will say “More than one match was found, would you like to play <playlist>?” If you say “Yes,” the system proceeds to step 6.

If you say “No,” the next matching playlist name is uttered by the system.

NOTE

- If you say “No” to three or all playlist names uttered by the system, the voice guide will say “Playlist not found, please try again” and the system returns to step 2.

7

6. After the voice guide says “Playing <playlist>,” the system creates an index for the playlist.

NOTE

- If the confirmation function is active, the voice guide confirms if the playlist name is correct. If the playlist name is correct, say “Yes”. If not, say “No”. After the voice guide says “Playlist not found, please try again,” the system returns to step 2. Refer to “Confirmation function setting” on page 5-57.

7. The system exits the voice recognition mode and starts playback.

To search by genre

N00772500010

1. Say “Play” on the main menu.

NOTE

- The Bluetooth® 2.0 interface starts recognizing the connected device. If the connected device cannot be recognized or a connection error occurs, the Bluetooth® 2.0 interface starts an appropriate voice guide. Follow the voice guide.

2. After the voice guide says “Would you like to play by Artist, Album, Playlist or Genre?,” say “Genre”.

NOTE

- If you say “Genre <type>,” you can skip step 3.

3. After the voice guide says “What Genre would you like to play?,” say the music type.

4. If there is only one match, the system proceeds to step 6.

5. If there are two or more matches, the voice guide will say “More than one match was found, would you like to play <genre>?” If you say “Yes,” the system proceeds to step 6.

If you say “No,” the next matching genre is uttered by the system.

NOTE

- If you say “No” to three or all genres uttered by the system, the voice guide will say “Genre not found, please try again” and the system returns to step 2.

6. After the voice guide says “Playing <genre>,” the system creates an index for the genre.

NOTE

- If the confirmation function is active, the voice guide confirms if the genre is correct. If the genre is correct, say “Yes”. If not, say “No”. After the voice guide says “Genre not found, please try again,” the system returns to step 2. Refer to “Confirmation function setting” on page 5-57.

7. The system exits the voice recognition mode and starts playback.

Steering wheel audio remote control switch (if so equipped)

N00714800471

The remote control switch is located on the left side of the steering wheel.

Steering wheel audio remote control switch (if so equipped)

It can be used when the electric motor switch is in the “ON” or “ACC” position.

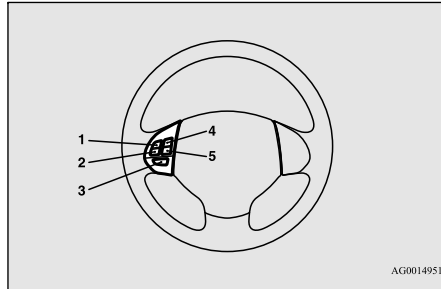

- 1- Volume up button
- 2- Volume down button
- 3- Power switch/Mode selector button
- 4- Seek up/Track up/File up/Fast-forward button
- 5- Seek down/Track down/File down/Fast-reverse button

NOTE

- Do not press multiple buttons at the same time when using the steering wheel audio remote control switch.

To turn on the power

Press the power switch to turn on the power. When the power is turned on, the last mode

used before turning off is displayed. To turn off the power, press and hold down the power switch for about 2 seconds until you hear a beep.

Volume control

Volume up button

While the button is pressed, the volume will continue to increase.

Volume down button

While the button is pressed, the volume will continue to decrease.

Mode selection

Press the mode selector button to select the desired mode.

The mode changes in the following order.
AM → FM1 → FM2 → CD → USB or iPod*
→ Bluetooth®* → AM

*: If you connect these devices.

To listen to the radio

Press the mode selector button and select AM or FM mode.

Automatic tuning

Seek up button/Seek down button

After pressing one of these buttons, a receivable station will be automatically selected and reception of the station will begin.

7

To listen to a CD

Press the mode selector button and select CD mode.

To fast forward/reverse the disc (music CDs only)

To fast forward or fast reverse the disc, press the fast-forward button or the fast-reverse button.

Fast forward

You can fast forward the disc by holding down the fast-forward button. While the but-

Error codes

ton is kept pressed, the disc will be fast-forwarded.

Fast reverse

You can fast reverse the disc by holding down the fast-reverse button. While the button is kept pressed, the disc will be fast-reversed.

NOTE

- With an MP3 CD, you can fast forward and fast reverse tracks in the same folder.

7

To select a desired track

You can select your desired track by using the track up button or the track down button.

NOTE

- Pressing the track down button once during the song will cause the system to restart playing from the beginning of the song.

To listen to an iPod

Press the mode selector button and select iPod mode.

To select a desired track

Track up button

Press the button repeatedly until the desired track number appears on the display.

NOTE

- The track number continues to increase while the button is pressed.

Track down button

Press the button repeatedly until the desired track number appears on the display.

NOTE

- The track number continues to decrease while the button is pressed.

To listen to a USB memory device

Press the mode selector button and select USB mode.

To select a desired file

File up button

Press the button repeatedly until the desired track number appears on the display.

NOTE

- The track number continues to increase while the button is pressed.

File down button

Press the button repeatedly until the desired track number appears on the display.

NOTE

- The track number continues to decrease while the button is pressed.

Error codes

N00736100777

If an error code appears in the display, take action in accordance with the table below.

7-24 Comfort controls

Handling of compact discs

Error display	Problem	Item	Repair
NO DISC	No disc inserted	Disc is not in CD player.	Insert disc.
CHECK DISC	Focus error	Disc is not loaded correctly, or condensation on disc.	Insert disc with label facing up. Remove moisture from disc.
DISC ERROR	Disc error	Disc is dirty, scratched, or deformed; or excessive vehicle vibration.	Clean or replace disc. Retry when vibrations stop.
INTERNAL E	Mechanism error	Loading or eject error. Pick-up is out of position.	Eject disc and reload. If disc will not eject, bring your vehicle to a certified i-MiEV dealer.
HEAT ERROR	Inside of audio system is hot.	Internal protection against high temperatures.	Allow radio to cool by waiting about 30 minutes.
ERROR DC	DC offset output voltage	Foreign material is inside of radio or amplifier.	Bring your vehicle to a certified i-MiEV dealer.
ERROR	Communication or power supply error	Communication error between external device and equipment. Power supply error of external device.	Bring your vehicle to a certified i-MiEV dealer.

7

Handling of compact discs

N00734100340

- Use only the type of compact discs that have the mark shown in the illustration below. (Playback of CD-R or CD-RW discs may cause problems.)



TA0000296

- The use of special shaped, damaged compact discs (like cracked discs) or low-quality compact discs (like warped discs or burrs on the discs) such as those shown will damage the CD player.

Handling of compact discs

7

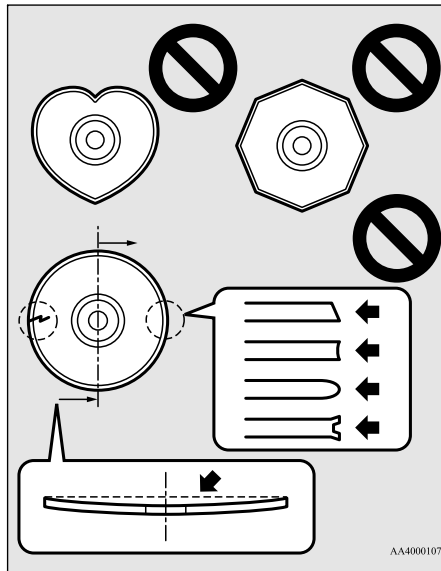

- In the following circumstances, moisture can form on compact discs and inside the audio system, preventing normal operation.

- When there is high humidity (for example, when it is raining).
- When the temperature suddenly rises, such as right after the heater is turned on in cold weather.

In this case, wait until the moisture has had time to dry out.

7-26 Comfort controls

- When the CD player is subjected to violent vibrations, such as during off-road driving, the tracking may not work.
- When storing compact discs, always store them in their separate cases. Never place compact discs in direct sunlight, or in any place where the temperature or humidity is high.
- Never touch the flat surface of the disc where there isn't a label. This will damage the disc surface and could affect the sound quality. When handling a compact disc, always hold it by the outer edge and the center hole.
- To clean a disc, use a soft, clean, dry cloth. Wipe directly from the center hole toward the outer edge. Do not wipe in a circle. Never use any chemicals such as benzine, paint thinner, a disc spray cleaner, or an anti-static agent on the disc.
- Do not use a ball point pen, felt pen, pencil, etc. to write on the label surface of the disc.
- Do not put additional labels or stickers on compact discs. Also, do not use any compact disc on which a label or sticker has started to peel off or any compact disc that has stickiness or other contamination left by a peeled-off label or sticker. If you use such a compact disc, the CD player may stop working properly and you may not be able to eject the compact disc.

Notes on CD-Rs/RWs

N00751900112

- You may have trouble playing back some CD-R/RW discs recorded on CD recorders (CD-R/RW drives), either due to their recording characteristics or dirt, fingerprints, scratches, etc. on the disc surface.
- CD-R/RW discs are less resistant to high temperatures and high humidity than ordinary music CDs and can therefore be damaged and rendered unplayable if left inside your vehicle for a long time.
- Depending on the combination of the writing software, the CD recorder (CD-R/RW drive), and the disc used to create a CD-R/RW, the disc might not play successfully.
- This player cannot play the CD-R/RW discs if the session is not closed.
- This player cannot play CD-R/RW discs which contain data other than CD-DA or MP3 data (Video CD, etc.).
- Be sure to observe the handling instructions for the CD-R/RW disc.

Antenna

WARNING

- Operating the CD player in a manner other than specifically instructed herein may result in hazardous radiation exposure. Do not remove the cover and attempt to repair the CD player by yourself. There are no user serviceable parts inside. In case of malfunction, contact a certified i-MiEV dealer.

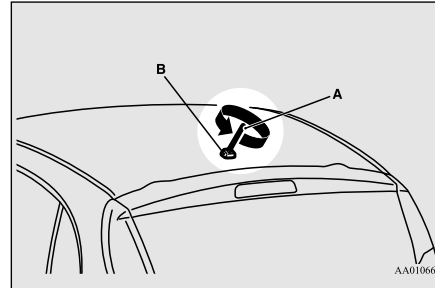

Antenna

N00734200471

To remove

Turn the pole (A) counterclockwise.

To install

Screw the pole (A) clockwise into the base (B) until it is securely retained.

NOTE

- Be sure to remove the roof antenna in the following cases:
 - When using an automatic car wash
 - When covering your vehicle with a car cover
 - When driving into a structure that has a low ceiling.

Clock (if so equipped)

N00755000124

The time is displayed when the electric motor switch is in the “ON” or “ACC” position.

To set the time

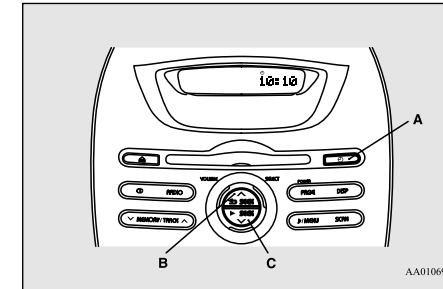

7

- A- Clock button
- B- SEEK **▲** (clock adjustment up) button
- C- SEEK **▼** (clock adjustment down) button

1. Press and hold the clock button and the clock display flashes.
2. Press the SEEK button to adjust the “hours” digit.
If you keep pressing the button, fast-forward begins.
3. When the “hours” digit is adjusted, press the clock button to flash the “minutes” digit.
Press the SEEK button to adjust the “minutes” digit.
If you keep pressing the button, fast-forward begins.

General information about your radio

- When the time is set, press the clock button to stop the clock display from flashing.

NOTE

- Reset the time after the 12V starter battery terminals are disconnected and reconnected.
- Seconds do not appear in the clock display, but after adjusting the “minutes” setting, the clock begins to operate from 0 seconds.

7

General information about your radio

N00733900439

Your vehicle’s radio receives both AM and FM stations.

The quality of your reception is affected by distance, obstacles, and signal interference.

This radio complies with Part 15 of Federal Communications Commission (FCC) Rules (for vehicles sold in U.S.A.). Operation is subject to the following conditions:

- The device may not cause harmful interference.
- This device must accept any interference received, including interference that may cause undesirable operation.

CAUTION

- Changes or modifications not expressly approved by the party meeting the above conditions could void the user’s authority to operate the equipment.

Signal transmission

FM signals do not follow the earth surface nor are they reflected by the upper atmosphere. For this reason, FM broadcasts cannot be received over long distances. AM signals follow the earth’s surface and are reflected by the upper atmosphere. For this reason, AM broadcasts can be received over longer distances.

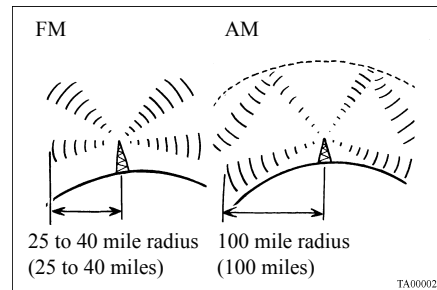

Weak reception (fading)

Because of the limited range of FM signals and the way FM waves transmit, you may experience weak or fading FM reception. When the broadcast is blocked by mountains or similar obstructions, reception can be disturbed.

Reflection

The reason why one can hear FM but not AM in parking garages, under bridges etc., is that FM signals, unlike AM signals, are reflected by solid objects such as buildings, etc.

Because FM signals are easily reflected by buildings, this can also cause reception disturbances.

The direct signal from the broadcast station reaches the antenna slightly before the reflected signal. This time difference may cause some reception disturbance or flutter.

This problem occurs primarily in urban areas.

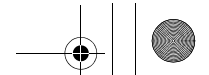

General information about your radio

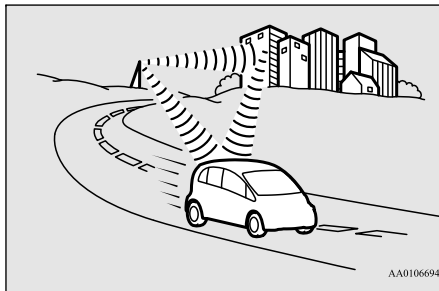

FM stereo reception

Stereo reception requires a high quality broadcast signal. This means that types of disturbances mentioned previously become more marked and the reception range is somewhat diminished during stereo reception.

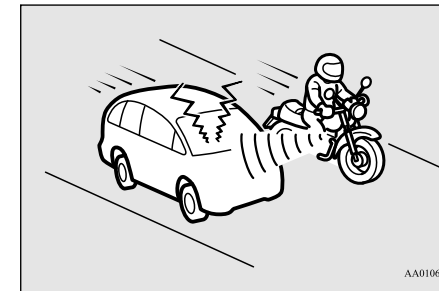

Causes of disturbances

FM reception is affected by the electrical systems of vehicles in the vicinity, especially those without an electronic noise suppression device. The disturbance is even greater if the station is weak or poorly tuned.

FM reception is not as sensitive to electrical disturbances as AM. AM reception is sensitive to electrical disturbances such as power lines, lightning and other types of similar electrical phenomena.

Cross modulation

If one listens to a weak station and is in the vicinity of another strong station, both stations might be received simultaneously.

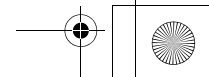
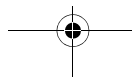
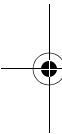
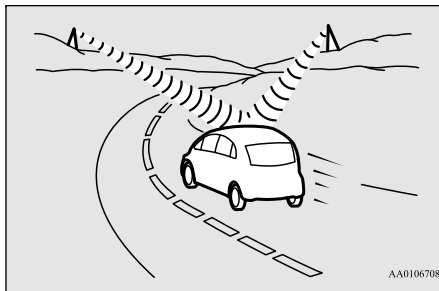

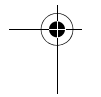
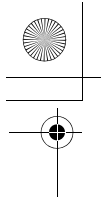

Handwriting practice area consisting of ten horizontal dashed lines.

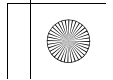
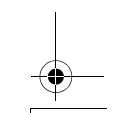
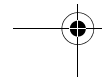
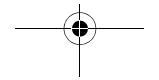
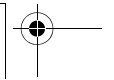
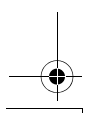
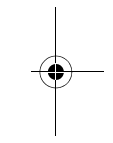
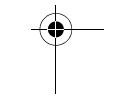
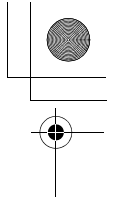
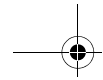
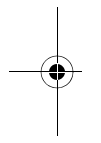

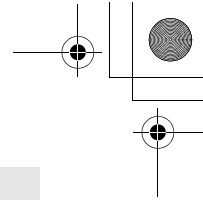
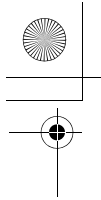

For emergencies

If the vehicle breaks down	8-2
Jump-starting	8-2
Tire repair kit	8-5
Towing	8-11
Operation under adverse driving conditions	8-13

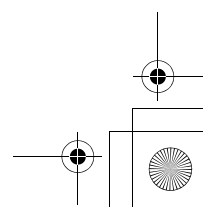
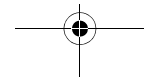
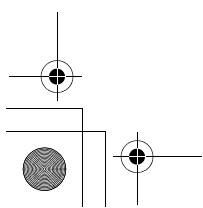
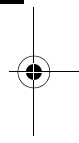
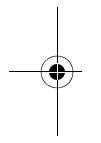

If the vehicle breaks down

If the vehicle breaks down

N00836301243

If your vehicle breaks down on the road, move to the shoulder and turn on the hazard warning flashers. If there is no shoulder, or the shoulder is not safe, drive in the right lane slowly, with the hazard lights flashing, until you come to a safe stopping place. Keep the flashers flashing.

If the ready indicator light goes out while driving, the brakes and steering will continue to work, but without power assist, so more effort will be required for braking and steering. Stop the vehicle on the shoulder of the road and turn on the hazard warning flashers. If you need to push your vehicle, turn the electric motor switch to the "ON" position, and place the selector lever in the "N" (NEUTRAL) position.

8

Jump-starting

N00836400742

If the electric motor unit cannot be energized because the 12V starter battery is weak or dead, you can start it with the battery from another vehicle using jumper cables.

8-2 For emergencies

⚠ WARNING

- To reduce the risk of igniting flammable gas that may be emitted from the 12V starter battery, carefully read this section before jump-starting the vehicle.
- Do not try to start the electric motor unit by pushing or towing the vehicle. This can cause an accident resulting in serious injury or death and can damage the vehicle.

⚠ CAUTION

- Do not attempt jump starting the 12V starter battery while the main drive lithium-ion battery is being charged. Doing so could damage the vehicle or charging equipment.

📖 NOTE

- Do not use jumper cables if they have damage or corrosion.

1. Take off any metal jewelry such as watch bands or bracelets that might make an accidental electrical contact.
2. Position the vehicles close enough together so that the jumper cables can reach, but be sure the vehicles are not touching each other.

⚠ CAUTION

- Check the other vehicle. It must have a 12V battery. If the other system is not 12V, both systems can be damaged.

3. Set the parking brake firmly on your vehicle and move the selector lever into the "P" (PARK) position.
4. Set the parking brake firmly on the other vehicle. Put the automatic transaxle in "P" (PARK) or the manual transaxle in "N" (Neutral).
5. Turn the ignition switch (the electric motor switch) on each vehicle to the "LOCK" position.

📖 NOTE

- Turn off all lights, heater, and other electrical loads. This will help avoid sparks.

6. Remove the battery cover, and then make sure your 12V starter battery electrolyte is at the proper level. (Refer to "Checking 12V starter battery electrolyte level" on page 9-8.)

Jump-starting

⚠ WARNING

- If the electrolyte fluid is not visible, or looks frozen, **DO NOT ATTEMPT JUMP STARTING!!**
The battery might split open or explode if the temperature is below the freezing point or if it is not filled to the proper level.

7. Connect one end of one jumper cable ① to the positive (+) terminal of the discharged battery (A), and then connect the other end ② to the positive (+) terminal of the booster battery (B).

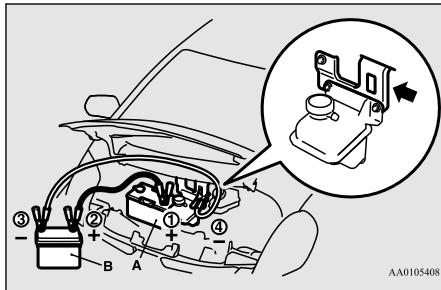

⚠ WARNING

- Make sure that the jumper cables and your clothing are clear of the cooling fans and drive belts. Entanglement with the fans or belts can cause serious personal injury.

📖 NOTE

- Open the terminal cover before connecting the jumper cable to the positive terminal of the 12V starter battery. (Refer to “Disconnection and connection” on page 9-9.)
- Use the proper cables suitable for the battery size. Otherwise heat damage to the cables could result.

8. Connect one end of the other jumper cable ③ to the negative (-) terminal of the booster battery (B), and then connect the other end ④ to the designated ground location of the vehicle with the discharged battery (A) at the point farthest from the battery.

⚠ WARNING

- Be sure to follow the proper order when connecting the batteries, of:
① → ② → ③ → ④.
- Make sure that the connection ④ is made to the correct designated location (as shown in the illustration) properly. If the connection is directly made to the negative (-) terminal of the battery, the flammable gases from inside the battery might catch fire and explode, causing personal injury.

⚠ WARNING

- When connecting the jumper cables, do not connect the positive (+) cable to the negative (-) terminal. Sparks can make the battery explode.

9. Start the engine in the vehicle providing the boost. Let the engine idle a few minutes, then start the electric motor unit by turning the electric motor switch to the ON position.

10. Check if the ready indicator illuminates.

[When the ready indicator illuminates]

Stop the engine of the other vehicle, and disconnect the cables in the reverse order and keep the electric motor switch in the ON position to charge the 12V starter battery for more than 30 minutes. After the 12V starter battery is charged, continue the process from step 17.

[When the ready indicator does not illuminate]

Both the 12V starter battery and the main drive lithium-ion battery have gone flat at the same time. Charge the 12V starter battery and the main drive lithium-ion battery by following steps from steps 11 to 15.

8

Jump-starting

11. Keep the jumper cables to each vehicle connected and turn the electric motor switch of your vehicle to the “LOCK” position.

NOTE

- The jumper cables need to be connected to the 12V starter battery when you start charging the main drive lithium-ion battery because the on board charger etc. operate utilizing power from the 12V starter battery.

8

12. Charge the main drive lithium-ion battery by regular charging. The 12V starter battery will automatically charge while the main drive lithium-ion battery is charging. (Refer to “Regular charging” on page 3-16.)
13. When the charging indicator on the instrument cluster is illuminated, stop the engine of the other vehicle and disconnect the jumper cables in the reverse order.

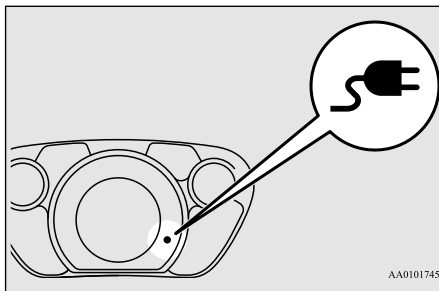

8-4 For emergencies

NOTE

- When the regular charge connector is connected to the charge port, the charging indicator will blink. When charging has started, the charging indicator will illuminate.

14. Charge the main drive lithium-ion battery for more than 1 hour.
15. Disconnect the charging cable. (Refer to “Regular charging” on page 3-16.)
16. Turn the electric motor switch to the “START” position, make sure that the ready indicator on the instrument cluster is illuminated. If the ready indicator does not illuminate, perform the procedure again starting from step 5. If charging cannot be performed, consult a certified i-MiEV dealer.
17. Refit the battery cover. (“Checking 12V starter battery electrolyte level” on page 9-8.)

Charging the 12V starter battery by using an external battery charger

WARNING

- Always remove the 12V starter battery from your vehicle when the 12V starter battery is charged by an external battery charger.
- Keep sparks, cigarettes and flames away from the 12V starter battery because the battery may explode.
- Keep your work area well vented when charging or using the 12V starter battery in an enclosed space.
- Remove all the caps before charging the 12V starter battery.
- Electrolyte (battery acid) is corrosive diluted sulphuric acid. If electrolyte comes in contact with your hands, eyes, clothes, or the painted surface of your vehicle, thoroughly flush with water. If electrolyte gets in your eyes, flush them immediately and thoroughly with water, and get prompt medical attention.
- Always wear protective clothing and goggles when working near the battery.
- Keep the battery out of the reach of children.

As your vehicle has anti-lock brakes

If you drive your vehicle with a low battery charge, after the electric motor unit has been started by using jumper cables, it can cause the anti-lock braking system warning light to illuminate. This is only due to the low battery voltage. It is not a problem with the brake system. If this happens, fully charge the 12V starter battery and ensure the charging system is operating properly.

Tire repair kit

N00836600366

This vehicle is equipped with a tire repair kit which can be used to repair a minor puncture in tread area caused by a nail, screw or similar object. A spare tire is not provided with this vehicle.

WARNING

- The tire repair kit may not permanently seal a punctured tire.
- Using the tire repair kit may damage the wheel and/or the tire inflation pressure sensor for the tire. The vehicle must promptly be inspected and repaired by a certified i-MiEV dealer after using the tire repair kit.

WARNING

- Use only the Mitsubishi genuine tire repair kit. Sealant in other repair kits may not sufficiently seal the tire puncture.

Tire repair kit storage

N00837701026

The tire repair kit is stowed under the rear seat cushion.

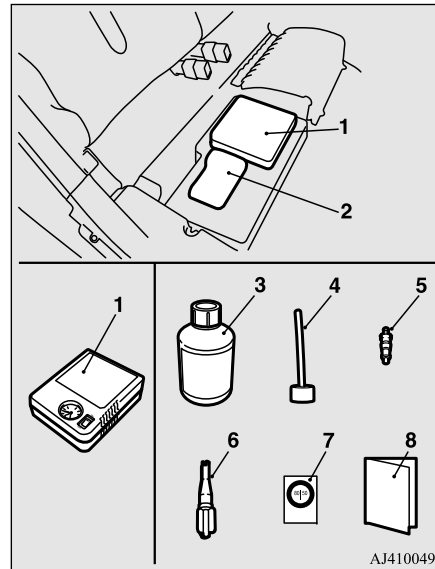

1- Tire compressor

Tire repair kit

- 2- Tire repair set: Items #3-#8 shown above
- 3- Tire sealant bottle
- 4- Filler hose
- 5- Valve insert (spare)
- 6- Valve remover
- 7- Speed restriction sticker
- 8- Instruction manual for tire repair

To remove

N00837800033

1. Pull forward the seat stoppers (A) under the rear seat cushion (B).
2. Lift up the seat cushion and pull it forward to remove it.

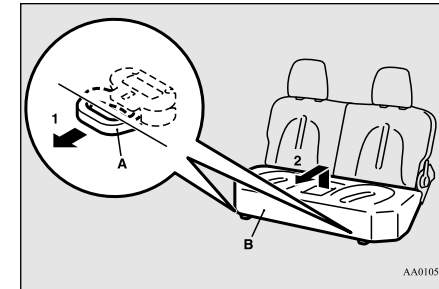

3. Remove the screws (C) with a coin or the washer (D) at a position shown in the illustration, and remove the cover (E).

For emergencies 8-5

Tire repair kit

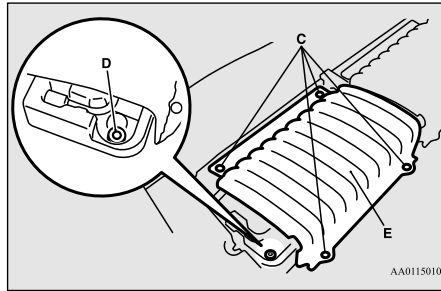

3. Pass both rear seat belt buckles through slits at the rear edge of the seat cushion. Make sure that the seat belt buckles are not twisted.

4. While pushing the seat cushion as far back as possible, press down hooks (A) under the seat cushion into the right and left stopper installation holes (B) until a click is heard.

4. Remove the tire repair kit.

8

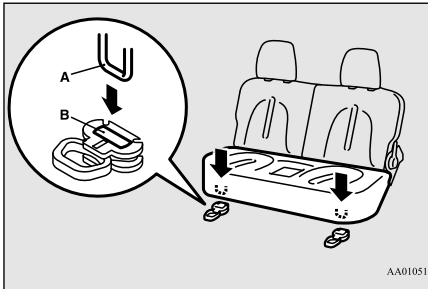
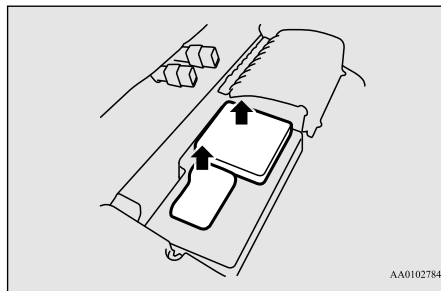

5. After installing the seat cushion, shake it lightly to confirm that it is properly fixed in position.

How to use the tire repair kit

N00800201049

⚠ WARNING

- Never use the tire repair kit under in any of the situations listed below. The tire cannot be repaired by the tire repair kit. If any of these situations occurs, please contact a certified i-MiEV dealer.
- More than one tire is punctured.
- The puncture hole has a length or width of 1/7 inch (4 mm) or greater.
- The tire is punctured in the side wall (A), not in the tread (B).
- The vehicle has been driven with the tire almost completely flat.
- The tire has completely slipped over the wheel rim and come off the wheel.
- The wheel is damaged.
- A bump, cut or crack is on the tire.
- The tire sealant's expiration date has passed. (The expiration date is shown on the bottle label (C).)
- Ambient temperature is below -22 °F (-30 °C) or above 140 °F (60 °C).

To store

N00837900018

1. Return the tire repair kit to its original place.
Attach the cover and fasten the screws.
2. Insert two wire tabs at the rear edge of the seat cushion under the seat back.

8-6 For emergencies

Tire repair kit

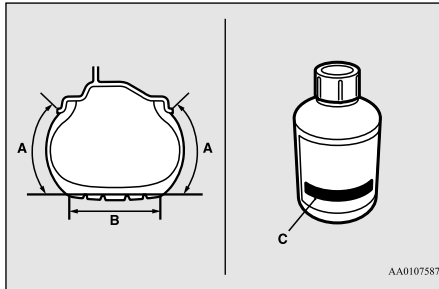

AA0107587

⚠ WARNING

- The tire sealant can cause health damage if swallowed. If you accidentally swallow it, drink as much water as possible and immediately seek medical attention.
- If the tire sealant gets in your eyes or on your skin, rinse it away with lots of water. If you still sense an abnormality, seek medical attention.
- Consult a doctor immediately if any allergic reactions occur.
- Do not allow children to touch the tire sealant.

⚠ CAUTION

- If the vehicle body is contaminated by the tire sealant, wipe the tire sealant off immediately with a wet cloth.
- Immediately wash clothes contaminated with tire sealant.

📖 NOTE

- Do not pull out an object, such as a nail or screw, that penetrates the punctured tire.
- Move the vehicle so that the tire valve is positioned away from the point where the tire touches the ground. If the valve is near the point where the tire touches the ground, the sealant may not enter the tire easily.

1. Park the vehicle on a safe, flat and level place.
2. Set the parking brake firmly.
3. Move the selector lever to the “P” (PARK) position and turn the electric motor switch to the “LOCK” position.
4. Turn on the hazard warning flashers and set up a warning sign, such as a warning triangle or flashing signal lamp, at an adequate distance from the vehicle, and have all your passengers leave the vehicle.
5. Take out the tire repair kit.

6. Take the valve cap (D) off the tire valve (E), then press the valve remover (F) onto the valve as illustrated. Allow all of the air in the tire to escape.

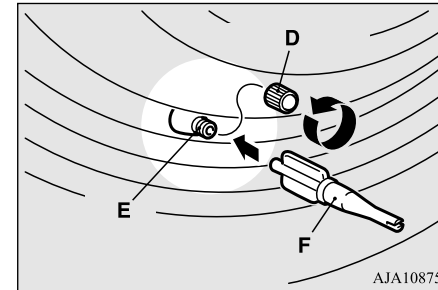

AJA108753

8

7. Remove the valve insert (G) by turning it counterclockwise using the valve remover (F). Put the removed valve insert in a clean place so it does not get dirty.

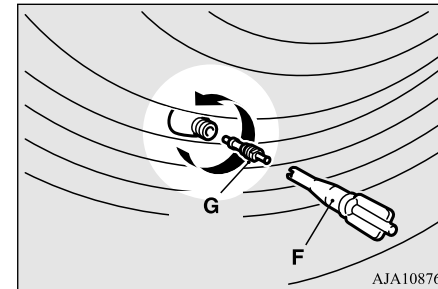

AJA108766

For emergencies 8-7

Tire repair kit

WARNING

- If there is any air left in the tire when you remove the valve insert, the valve insert may fly out and injure you. Make sure the tire contains no air before removing the valve insert.

NOTE

- Turn the valve remover by hand. If you use a tool, the valve remover could be damaged.

8

8. Shake the tire sealant bottle well.

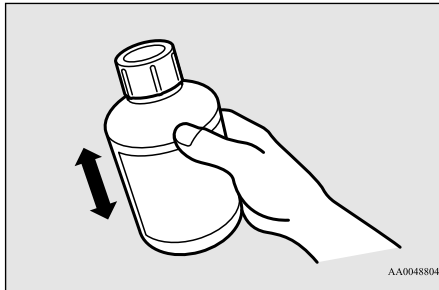

NOTE

- In cold conditions (when the ambient temperature is 32 °F {0 °C} or lower), thickening of the tire sealant can make the tire sealant hard to squeeze out of the bottle. Warm the bottle between your hands inside the vehicle.

9. Take the cap (H) off the tire sealant bottle (I). Do not remove the seal (J). Screw the filler hose (K) onto the bottle (I). As you screw the filler hose onto the bottle, the seal will break, allowing the sealant to be used.

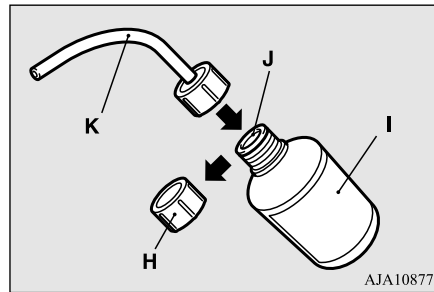

CAUTION

- If you shake the bottle after screwing on the hose, sealant may spray out of the hose.

10. Press the hose onto the valve. Holding the sealant bottle upside-down, squeeze it again and again to inject all of the sealant into the tire.

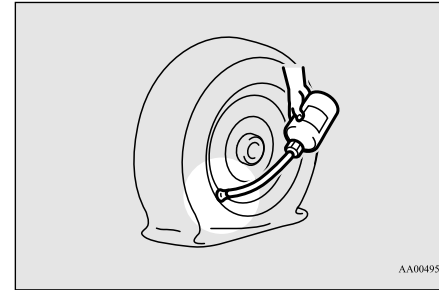

11. After injecting the sealant, pull the hose off the valve, remove any residual sealant from the valve, rim and/or tire. Fit the valve insert (G) into the valve (E), and screw the valve insert securely into place using the valve remover (F).

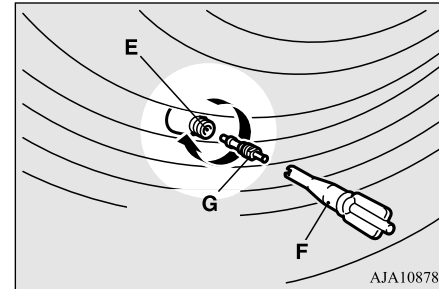

8-8 For emergencies

Tire repair kit

12. After injecting the sealant, securely fit the valve remover (F) into the end of the filler hose (K) to prevent sealant from leaking from the empty bottle.

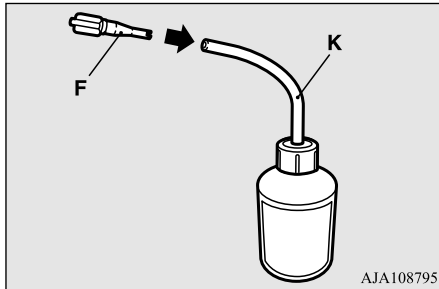

13. Pull out the compressor hose (L) from the side of the tire compressor, and then securely attach the hose to the tire valve (E).

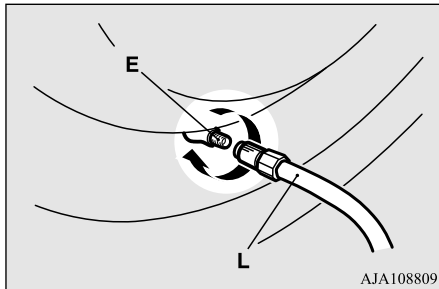

14. Place the compressor (M) with its air pressure gauge (N) on top.

Pull out the compressor's power cord (O), insert the plug on the cord into the 12 V power outlet (P), and then turn the electric motor switch to the "ACC" position. (Refer to "12V power outlet" on page 5-76.)

Turn ON the compressor switch (Q) and inflate the tire to the specified pressure. (Refer to "Tire inflation pressures" on page 9-13.)

If there is a gap between the tire and wheel, push the tread area toward the center of the wheel to close the gap before running the compressor.

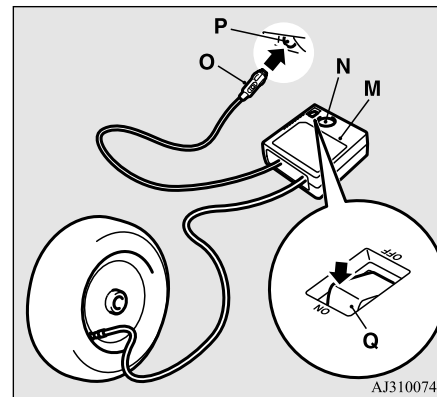

WARNING

- Do not place your hand or fingers between the tire and wheel while inflating the tire. Your hand or fingers may become caught between the tire and wheel.

CAUTION

- The supplied compressor is designed only for inflation of your vehicle tires.
- The compressor is designed to run on a vehicle's 12 V power supply. Do not connect it to any other power source.
- The compressor is not waterproof. If you use it in rain, make sure water does not get on it.
- Any sand or dust sucked into the compressor could make the compressor break down. Do not place the compressor directly on any sandy or dusty surface when using it.
- Do not disassemble or modify the compressor. Also, do not subject the air pressure gauge to shock. It could malfunction.

15. Check and adjust the tire pressure with reference to the air pressure gauge on the compressor. If you overinflate the tire, release air by loosening the hose's end fitting.

Tire repair kit

If there is a gap between the tire and wheel because the tire has moved inward from the wheel rim, press the tire tread towards the wheel to close the gap before running the compressor. (With no gaps, the tire pressure will rise.)

CAUTION

- The surface of the compressor will get hot while the compressor is running. Do not keep the compressor running continuously for more than 10 minutes. After using the compressor, wait for the compressor to cool before using it again.
- If the compressor becomes sluggish or hot while operating, it is overheating. Immediately place the switch in the OFF position and let the compressor cool down for at least 30 minutes.

8

NOTE

- If the tire pressure does not rise to the specified level within 10 minutes, the tire may be so severely damaged that the tire sealant cannot be used to effect the emergency repair. Do not drive the vehicle. Please contact a certified i-MiEV dealer.

16. Turn OFF the compressor switch, then pull the power cord plug out of the 12 V power outlet.

NOTE

- At this point the puncture hole is not sealed yet. Air will leak through the puncture hole until the emergency repair procedure is completed (through step 19 or step 20 of these instructions).

17. Affix the speed restriction sticker (R) to the three-diamond mark on the steering wheel.

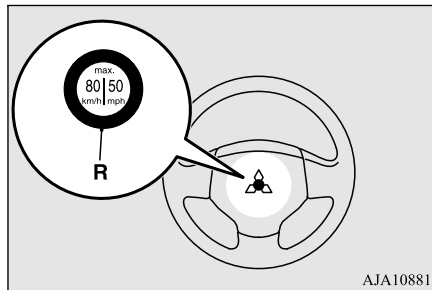

CAUTION

- Do not affix the sticker anywhere except the specified position on the pad of the steering wheel. Affixing the sticker in an incorrect position could prevent the SRS airbag from deploying properly.

18. When you have inflated the tire to the specified pressure, stow the compressor, bottle, and other items in the vehicle and make sure that the seat cushion is properly secured. (Refer to “Tire repair kit storage” on page 8-5.) Promptly start driving the vehicle so that the tire sealant can spread evenly in the tire. Drive with great care. Do not exceed a speed of 50 mph (80 km/h). Observe local speed limits.

CAUTION

- If you sense any abnormality while driving, stop the vehicle and contact a certified i-MiEV dealer. Otherwise the tire pressure may drop before the emergency repair procedure is completed, rendering the vehicle unsafe to drive.

19. After driving for 10 minutes or 3 miles (5 km), park the vehicle in safe place. Remove the air compressor from the stowed position. Check the tire pressure using the air pressure gauge on the compressor. If the tire pressure has apparently not dropped, the emergency repair procedure is complete. Continue the process from step 21.

If the tire pressure is not sufficient, inflate the tire to the specified pressure again and drive the vehicle carefully without exceeding a speed of 50 mph (80 km/h).

Towing

Before driving, stow the compressor and make sure that the rear seat cushion is properly secured.

CAUTION

- If the tire pressure is lower than the minimum permitted pressure (18 psi {130 kPa}), the tire cannot successfully be repaired with the tire sealant. Do not drive the vehicle any further. Contact a certified i-MiEV dealer.

20. After driving for 10 minutes or 3 miles (5 km) again, check the tire pressure using the air pressure gauge on the compressor. If the tire pressure has apparently not dropped, the emergency repair procedure is complete. Before driving, make sure that the compressor is stowed and the seat cushion is properly secured. You must still not exceed a speed of 50 mph (80 km/h). Observe local speed limits.

NOTE

- If the tire pressure has dropped below the specified level when you check it at the end of the repair procedure, do not drive the vehicle any further. Contact a certified i-MiEV dealer.

NOTE

- In cold conditions (when the ambient temperature is 32 °F {0 °C} or lower), the time and driving distance necessary until completion of the repair can become longer than in warmer conditions, and the tire pressure may drop below the specified level even after you have inflated the tire the second time and subsequently driven the vehicle. If this happens, inflate the tire to the specified pressure once more, drive for about 10 minutes or 3 miles (5 km), then check the tire pressure again. If the tire pressure has again dropped below the specified level, stop driving the vehicle and contact a certified i-MiEV dealer.

21. Immediately drive with great care to a certified i-MiEV dealer and have tire repair/replacement performed.

NOTE

- Please give the empty sealant bottle to a certified i-MiEV dealer or dispose of the sealant bottle according to regulations for the disposal of chemical waste.

Towing

N00837001931

If your vehicle needs to be towed

If you need to tow your vehicle, contact a certified i-MiEV dealer or a commercial tow truck service.

Transport the vehicle on a flatbed truck or tow the vehicle either with all wheels or the rear wheels (drive wheels) off the ground.

8

Flat bed type

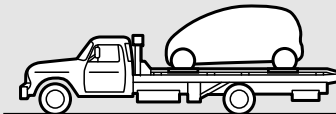

Dolly type

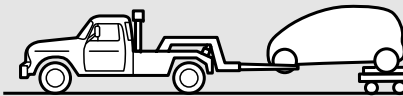

Towing with rear wheels off the ground

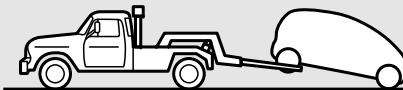

AJM101543

For emergencies 8-11

Towing

⚠ WARNING

- Never tow the vehicle with rear wheels (drive wheels) on the ground. This may cause damage to the electric motors. Also this may cause a fire, if wiring in the electric motor unit room becomes damaged.

Towing with all wheels on the ground

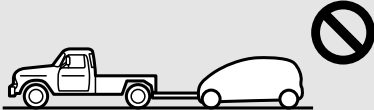

Towing with front wheels off the ground

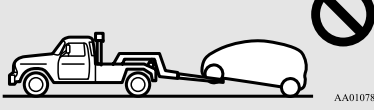

8

⚠ CAUTION

- Never tow the vehicle using a sling type truck. Doing so will damage the bumper and/or body.

Towing with a sling-type truck

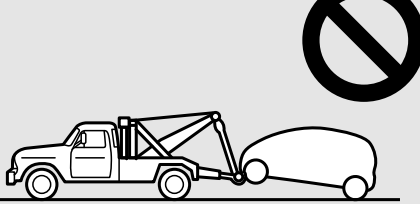

AA0107662

⚠ CAUTION

- Never attempt to tow the vehicle using another vehicle with a rope.
- Never tow another vehicle using your i-MiEV

If a wheel gets stuck in a ditch, do not try to tow the vehicle.

Please contact a certified i-MiEV dealer or a commercial tow truck service for assistance. There may be local regulations concerning towing in your area. Obey the regulations in the area where you are driving your vehicle.

Towing the vehicle by a tow truck

⚠ WARNING

- Never get under your vehicle after it has been lifted by a tow truck.
- Never ride in a vehicle that is being towed.

Towing with rear wheels off the ground

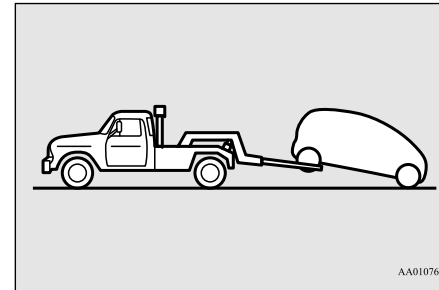

AA0107688

Place the selector lever in the “N” (NEUTRAL) position. Turn the electric motor switch to the “ACC” position and secure the steering wheel in a straight-ahead position with a rope or tie-down strap. Never place the electric motor switch in the “LOCK” or “ON” position when towing.

CAUTION

- If the transmission or the steering system has a problem or damage, transport the vehicle on a flatbed truck or tow the vehicle with the all wheels off the ground.
- If the electric motor switch is in the “ON” position, the Active Stability Control (ASC) system may operate, resulting in an accident. Make sure the electric motor switch is in the “ACC” position before towing.

Operation under adverse driving conditions

N00837200747

If your vehicle becomes stuck in sand, mud or snow

If your vehicle becomes stuck in snow, sand, or mud, it can often be moved by a rocking motion. Rock your vehicle back and forth to free it.

Do not spin the wheels. Constant efforts to free a stuck vehicle can cause transmission failure.

If your vehicle is still stuck after several rocking attempts, call for a commercial tow truck service.

WARNING

- **When trying to rock your vehicle out of a stuck position, make sure that there are no people nearby. The rocking motion can make your vehicle suddenly lurch forward or backward, and injure any bystanders.**

On wet roads**CAUTION**

- Do not drive on a flooded road. If you drive on a flooded road, not only the electric motor unit stops but also a failure like electric leakage or short circuit may occur. If you inevitably had to run on a flooded road and the vehicle was exposed to water, be sure to have your vehicle inspected by a certified i-MiEV dealer.
- When driving in rain, on water-covered roads, or through a car wash, water could get into the brake discs and make them fail temporarily. In such cases, lightly press the brake pedal to see if they are working properly. If they are not, press the pedal lightly several times while driving to dry the brake pads or linings, then check them again.
- When driving in rain, a layer of water may form between the tires and the road surface (aquaplaning). This loosens your tires' grip on the road, making it difficult to steer or brake properly. When driving on a wet road:
 - Drive your vehicle at a safe speed.

Operation under adverse driving conditions**CAUTION**

- Do not drive on worn tires.
- Always keep the tires at the correct inflation pressures.

On snowy or icy roads

- When driving on a road covered with snow or ice, use snow tires. Tire chains cannot be used on your vehicle. There may be state or local regulations about using snow tires. Always check the regulations in your local area before using them. Refer to the section entitled “Snow tires” on page 9-15 and “Tire chains” on page 9-16.
- Drive slowly. Do not make sudden starts or stops, sharp turns, or slam on the brakes.
- Allow extra distance between your vehicle and the vehicle in front of you, and avoid sudden braking.
- If a skid occurs when the accelerator pedal is depressed, take your foot off the pedal. Steer gently in the direction of the skid.
- Your vehicle is equipped with an anti-lock braking system (ABS), hold the brake pedal down firmly and keep it depressed. Do not pump the brake pedal which will result in reduced braking performance.

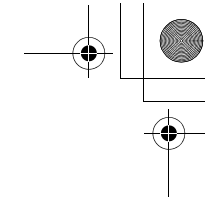
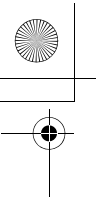

Operation under adverse driving conditions

- After parking on snowy or icy road, it may be difficult to move your vehicle due to freeze-up of the brake. Depress the accelerator pedal little by little to move the vehicle after confirming safety of the vehicle.

CAUTION

- parked too closely against a curb or parking block, or by the side of a road with curbstones;
- driven on a steep slope.

CAUTION

- Do not depress the accelerator pedal rapidly. The vehicle could start moving when it breaks free from the ice, possibly resulting in an accident.

8

On a bumpy or rutted road

- Drive as slow as possible when driving on bumpy or rutted roads or over potholes etc.

CAUTION

- Driving on bumpy, rutted roads or over potholes can damage the tires and wheels. Wheels with low-profile tires or under-inflated tires are especially at risk for damage.
- The vehicle's body, bumper, muffler and other parts may be damaged if the vehicle is:
 - driven over a step (for example, at the entrance or exit of a parking lot);

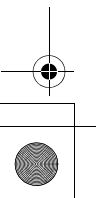

8-14 For emergencies

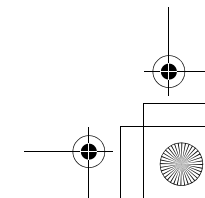
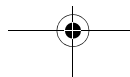

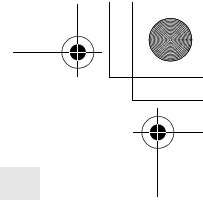
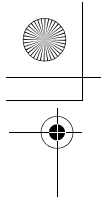

Vehicle care and maintenance

Service precautions	9-2
Hood	9-3
View under the hood and electric motor unit room	9-4
Coolant/Hot water heater fluid	9-4
Washer fluid	9-7
Brake fluid	9-7
12V starter battery	9-7
Tires	9-10
Brake pedal free play	9-16
Parking brake lever stroke	9-16
Wiper blades	9-16
General maintenance	9-17
For cold and snowy weather	9-18
Fusible links	9-18
Fuses	9-18
Replacement of light bulbs	9-21
Vehicle care precautions	9-28
Cleaning the inside of your vehicle	9-28
Cleaning the outside of your vehicle	9-30

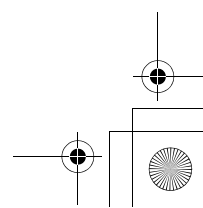
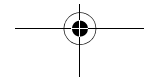
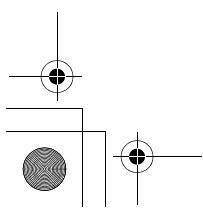
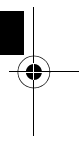
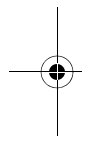

Service precautions

Service precautions

N00937301414

Taking regular care of your vehicle helps preserve its value and appearance as long as possible.

This vehicle is an electric vehicle and is equipped with many high-voltage components. Refer to “High-voltage components” on page 3-34.

You can do some of the maintenance work described in this manual by yourself, but the rest must be performed only by a certified i-MiEV dealer.

9

If you discover a malfunction or other problem, have it corrected by a certified i-MiEV dealer.

Also follow the instructions and take note of the precautions for each procedure.

⚠ WARNING

- Never touch, remove or disassemble the high-voltage components including high-voltage wires colored orange and their connectors. Doing so can result in a fire, property damage, electrocution and serious injury or death.

These components are affixed with a label indicating precautions for handling. Follow the instructions on the label. Take your vehicle to a certified i-MiEV dealer for any necessary maintenance.

High voltage components and wiring cables are located as shown in the figure below.

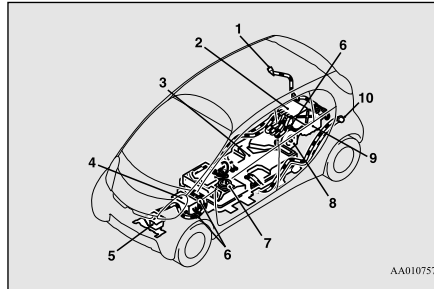

- 1- Regular charge port
- 2- MCU
- 3- Main drive lithium-ion battery
- 4- Heater
- 5- Air conditioner compressor
- 6- High voltage connector
- 7- Service plug
- 8- Electric motor (Electric motor unit)
- 9- On board charger/DC-DC converter
- 10- Quick charge port

⚠ WARNING

- When servicing the vehicle, make sure that the electric motor switch is in the “LOCK” position and the charging cable is disconnected. Failure to do so could result in an electric shock.

⚠ WARNING

- When checking or servicing under the hood or the coolant reserve tank, be sure the electric motor unit is stopped and it has had a chance to cool down.
- If you need to work under the hood with the electric motor unit on, be careful that your clothing, hair, etc. does not get caught in the fan or other moving parts.
- The fan can turn on automatically even if the electric motor unit is not running. Turn the electric motor switch to the “LOCK” position to be safe while you are working under the hood.
- Do not smoke or allow open flames around the 12V starter battery.
- Be extremely careful when working around the 12V starter battery. It contains poisonous and corrosive sulfuric acid.
- Handling your vehicle’s parts and materials in the wrong way can injure you. Ask a certified i-MiEV dealer if you have questions.

⚠ CAUTION

- The components inside the electric motor unit room may be very hot to the touch. Make sure all components have sufficiently cooled before beginning an inspection. These components are affixed with a label indicating precautions for handling. Follow the instructions on the label.

Hood

CAUTION

- When replacing the 12V starter battery, remove the positive (+) and negative (-) terminals after turning the electric motor switch to the "LOCK" position and waiting at least 2 minutes. If the 12V starter battery terminal is removed just after the electric motor switch is turned to the "LOCK" position, this may cause damage to electric components. If the electric motor unit warning light illuminates, do not replace the 12V starter battery. Contact a certified i-MiEV dealer.

Hood

N00937500549

To open

Use the hood release lever (located under the instrument panel near the passenger's door) to unlock the hood.

Pull the lever toward you to release the hood latch.

Release the safety lever (A) and lift the hood.

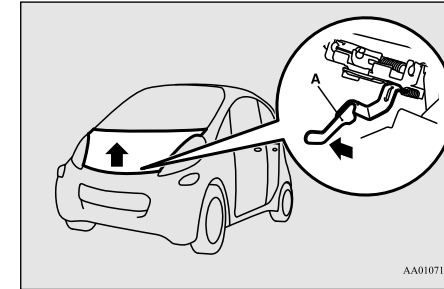

AA0107109

NOTE

- To prevent damage to the hood and wipers, make sure the wipers are at resting position when you open the hood.

Support the hood by inserting the support prop (B) into its slot on the underside of the hood arm.

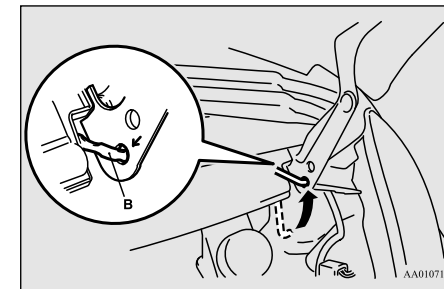

AA0107112



**DIAMOND CARE
PROTECTION PLAN**

Have you purchased the Mitsubishi Motors Diamond Care Protection Plan? The Plan supplements your new vehicle warranties. See a certified i-MiEV dealer for details.

WARNING

- Never use the release lever to unlatch the hood while the vehicle is in motion.
- Do not drive your vehicle unless the hood is locked.

View under the hood and electric motor unit room

⚠ CAUTION

- Always insert the support prop into the hole specially made for it. Propping the hood at any other place could cause the prop to slip out and lead to an accident.
- The hood prop can fall out if the hood is lifted by a strong wind.

⚠ CAUTION

- Make sure the hood is firmly closed before driving.
- If you drive without the hood completely closed, it could open up while driving.

Electric motor unit room

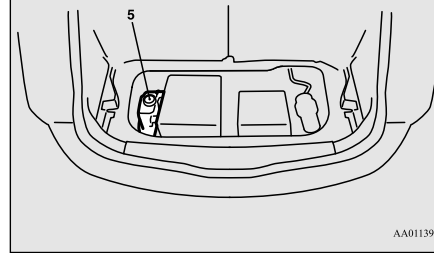

- 1- Windshield washer fluid reservoir
- 2- 12V starter battery
- 3- Hot water heater reservoir
- 4- Brake fluid reservoir
- 5- Coolant reservoir

To close

Make sure the hood is securely locked by softly lifting the centre of the hood.

📖 NOTE

- If this does not close the hood properly, drop it again from a slightly higher position.
- Do not push down strongly on the hood. Depending on how strongly or where you push down, you could create a dent in the hood.

9

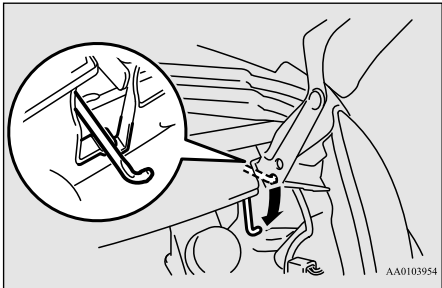

Slowly lower the hood about 12 inches (30 cm), then let it drop from its own weight.

View under the hood and electric motor unit room

N00937600700

Under the hood

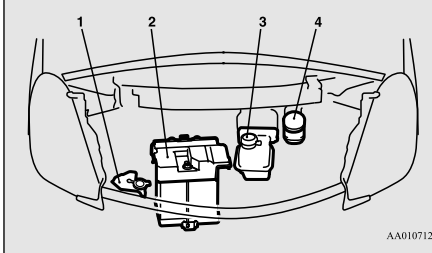

Coolant/Hot water heater fluid

N00937800539

To check the coolant level

⚠ WARNING

- Before checking the coolant level, make sure the electric motor switch is in the "Lock" position to avoid the risk of an electrical shock that can result in serious injury or death.

WARNING

- The room under the hood and the electric motor unit room (located under the luggage room carpet) can be very hot after driving. Wait until they have cooled down.

NOTE

- A heat insulating material is attached to the luggage room floor carpet. To remove the luggage room carpet, grasp and lift up both the carpet fabric and the heat insulating material.

Coolant

1. Open the liftgate.

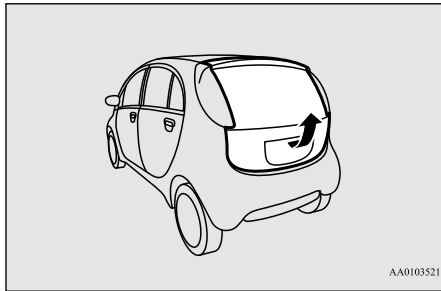

2. Peel off the Velcro fastener (A) to remove the luggage room floor carpet (B).

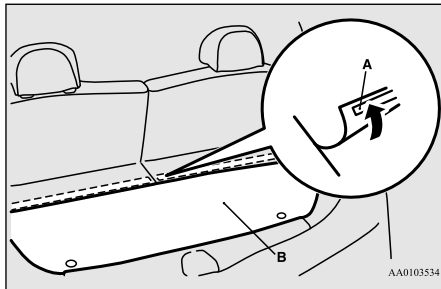

3. Turn the 4 screws on the front and rear of the electric motor unit room lid (C) counterclockwise to loosen and remove them, and then remove the electric motor unit room lid (C).

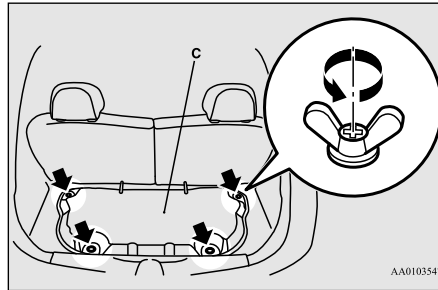

NOTE

- When laying the electric motor unit room lid on the ground, leave the underside of the lid with the rubber surface facing up. If the underside is facing downward debris and other foreign material could get on the rubber surface and prevent proper reinstallation of the electric motor unit room lid.

Coolant/Hot water heater fluid

4. Check the coolant level in the reservoir (D).

While the motor is cold, the coolant level must always be between the “F (FULL)” and the “L (LOW)” marks. If necessary, add coolant. Refer to “To add coolant” on page 9-6.

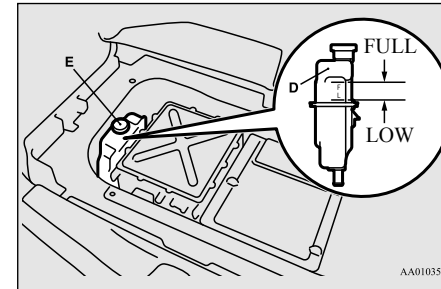

WARNING

- Never touch components inside the electric motor unit room except the reservoir (D).

5. Reinstall the electric motor unit room lid and the luggage room floor carpet by following the removal procedures in reverse.

Hot water heater fluid

The reservoir (A) is located under the hood.

Coolant/Hot water heater fluid

The coolant level in this reservoir should be kept between the “F (FULL)” and the “L (LOW)” marks when measured while the electric motor is cold. If necessary, add coolant. Refer to “To add coolant” on page 9-6.

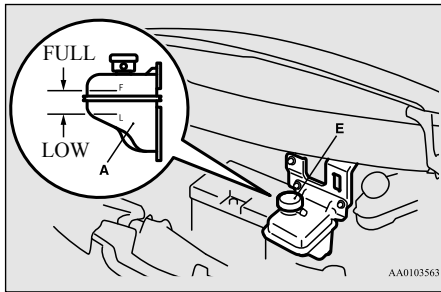

9

To add coolant

Use “Mitsubishi Motors Genuine Super Long Life Coolant Premium” or an equivalent*.

*: similar high quality ethylene glycol based non-silicate, non-amine, non-nitrate and non-borate coolant with long life hybrid organic acid technology

Mitsubishi Motors Genuine Coolant provides excellent protection against corrosion and rust formation on all metals, including aluminum.

9-6 Vehicle care and maintenance

If you need to add coolant often, the cooling system should be pressure-tested for leaks. Take your vehicle to a certified i-MiEV dealer for testing.

CAUTION

- Do not use alcohol or methanol antifreeze or any coolants that contain them. Using the wrong antifreeze can corrode aluminum parts.
- The required concentration of anti-freeze differs depending on the expected ambient temperature.
Above -31 °F (-35 °C): 50 % concentration of anti-freeze
Below -31 °F (-35 °C): 60 % concentration of anti-freeze
You can check the concentration level with a gauge from an automotive supply store, or a certified i-MiEV dealer or service station can check it for you.
- Do not use water to adjust the concentration of coolant.
- Do not top off the tank with plain water only. Water by itself boils at a lower temperature and does not stop rust or freezing. If the water freezes, it will damage your cooling system. Do not use tap water. It can cause corrosion and rust.

Reservoir cap

N0095580010

The reservoir cap (E) must be tightly sealed to prevent losing coolant which may result in electric motor or nearby parts of the room under the hood damage. Only use a Genuine Mitsubishi Parts reservoir cap, or an approved equivalent.

WARNING

- Wait for the electric motor to cool down before opening the reservoir cap. Otherwise hot steam or boiling coolant could spray up from the reservoir and scald you.

Points to remember

N0095570019

- Do not overfill the reservoir.
- Your vehicle uses a special reservoir cap that stays sealed and keeps the pressure in the reservoir below the allowable pressure. If you need to change the cap, use the exact same kind.
- Check the coolant freeze point in the radiator with the proper gauge, and only when it is safe. If you add antifreeze, the contents of the reservoir must be protected against freezing.
- Keep the front of the radiator and condenser clean.

Washer fluid

Washer fluid

N00938600303

The windshield washer fluid reservoir is under the hood.

Check the washer fluid level at regular intervals and add washer fluid to reservoir if necessary.

Open the reservoir cap and check the fluid level.

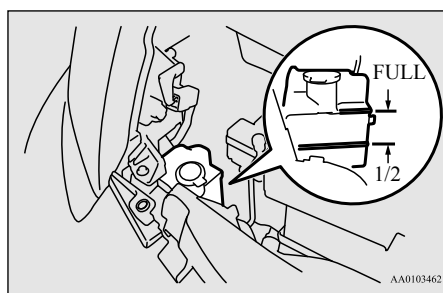

During cold weather

When freezing weather is anticipated, flush out the water in the reservoir by operating the pump. Fill the reservoir with windshield anti-freeze (not radiator antifreeze), and operate the system for a few seconds to flush out the residual water.

Brake fluid

N00938700261

To check the fluid level

The brake fluid level must be between the “MAX” and “MIN” marks on the reservoir.

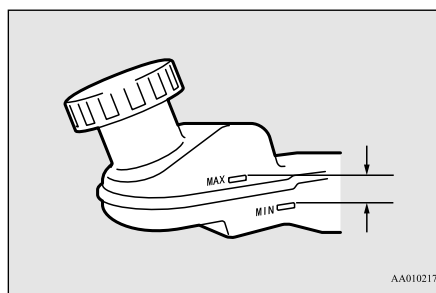

The brake fluid level falls slightly with wear of the brake pads, but this does not indicate any abnormality.

The brake fluid in the master cylinder should be checked when doing other work under the hood. The brake system should also be checked for leaks at the same time.

If the brake fluid level falls markedly in a short length of time, it indicates a leak in the brake system.

If this occurs, have the vehicle checked by a certified i-MiEV dealer.

Fluid type

Use the recommended brake fluid conforming to DOT 3 or DOT 4. The reservoir cap must be tightly sealed to keep dirt and water out.

CAUTION

- Do not let any petroleum-based fluid touch, mix with, or get into the brake fluid. This will damage the seals.
- Be careful when handling brake fluid. It can damage painted surfaces.
- Use only the listed brake fluid. Different brands of brake fluid have different additives, and these can cause a chemical reaction. Do not mix brands of brake fluid.
- Keep the reservoir tank cap closed to keep the brake fluid from evaporating.

12V starter battery

N00939100914

The condition of the 12V starter battery is very important to keep the vehicle's electrical system working properly. Check the 12V starter battery regularly.

12V starter battery

Removing and installing the 12V starter battery upper cover

N00901300054

To remove

1. Turn the plastic nut (A) counterclockwise, and then remove the 12V starter battery upper cover (B).

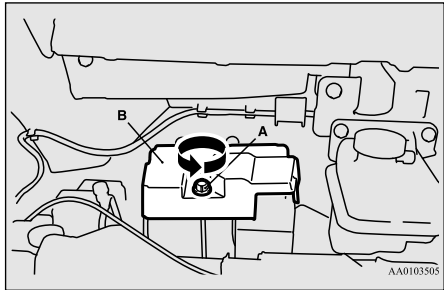

9

NOTE

- Be careful not to lose the removed plastic nut.

To install

1. Install the 12V starter battery upper cover (B) onto the 12V starter battery, and then push the plastic nut (A) in the direction shown by the arrows to secure the cover.

9-8 Vehicle care and maintenance

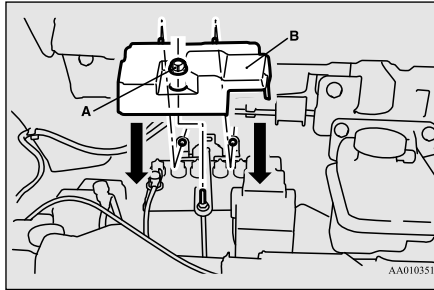

CAUTION

- Be sure to install the 12V starter battery upper cover. Otherwise, the battery electrolyte may spill and cause a malfunction.
- When installing the 12V starter battery upper cover and plastic nut do not touch the cooling fan or other moving parts under the hood. Be especially careful that the cables, your clothing or hair, etc., do not get caught in the cooling fan or other moving parts.

NOTE

- Be sure to install the plastic nut in the correct direction.

Checking 12V starter battery electrolyte level

N00901500069

Before checking the 12V starter battery electrolyte level, remove the 12V starter battery's upper cover.

The electrolyte level must be between the limits shown on the outside of the 12V starter battery. Fill it with distilled water as needed. The inside of the 12V starter battery is divided into several compartments. Take the cap off of each compartment and fill to the mark.

Do not fill above the top line because a spill during driving could cause damage.

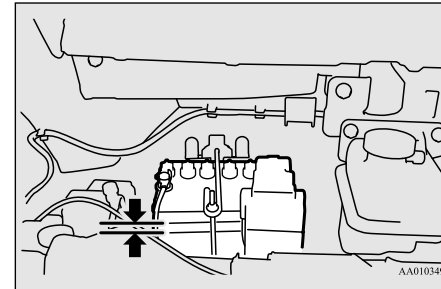

WARNING

- If the 12V starter battery goes flat, be sure to check the 12V starter battery electrolyte level before connecting booster cables.

12V starter battery

⚠ WARNING

- After checking the 12V starter battery electrolyte level, make sure the caps are fitted securely.
- If any of the caps cannot be re-secured to the 12V starter battery, replace the 12V starter battery.
- Electrolyte (battery acid) is made of corrosive diluted sulfuric acid. If it spills on nearby parts, it can crack, stain, or discolor them. And if gets on your skin or in your eyes, it can cause burns or blindness. Please observe the following handling instructions:
 - If electrolyte gets on plastic parts or other nearby parts, wipe it off with a soft cloth or chamois soaked in a solution of water and neutral detergent then immediately rinse the affected parts with plenty of water.
 - If electrolyte gets on your hands or clothes, rinse thoroughly with water. If electrolyte gets in your eyes, flush them with water immediately and get immediate medical attention.

During cold weather

N00901600057

The 12V starter battery is weaker in cold temperatures. This has to do with its chemical and physical properties and is why a very cold 12V starter battery, especially one with a

low charge, will have a hard time starting your vehicle.

It is recommended that you have your 12V starter battery and charging system checked by a certified i-MiEV dealer before the start of cold weather. If necessary, have it charged. This will guarantee more reliable starting, and longer 12V starter battery life.

Disconnection and connection

N00901701114

To disconnect the 12V starter battery cable, stop the electric motor. Disconnect the negative (-) terminal first, then the positive (+) terminal. To reconnect the 12V starter battery, first connect the positive (+) terminal and then the negative (-) terminal, before starting the vehicle.

⚠ WARNING

- Never disconnect the 12V starter battery while the electric motor unit is running, or you could damage the vehicle's electrical parts.
- Never short-circuit the 12V starter battery. This could cause it to overheat and be damaged.
- Keep sparks, cigarettes, and flames away from the 12V starter battery because the 12V starter battery could explode.

⚠ WARNING

- When installing the 12V starter battery, start connection with the positive (+) terminal. If connection is started from the negative (-) terminal, sparks will occur if the positive (+) terminal touches any other parts, and this may cause the 12V starter battery to explode.

📖 NOTE

- Remove the 12V starter battery upper cover before disconnecting the terminal of 12V starter battery. Refer to "Removing and installing the 12V starter battery upper cover" on page 9-8.
- Open the terminal cover (A) before disconnecting or connecting the positive (+) terminal of the 12V starter battery.
- Loosen the nut (B), and then disconnect the 12V starter battery cable from the positive (+) terminal.

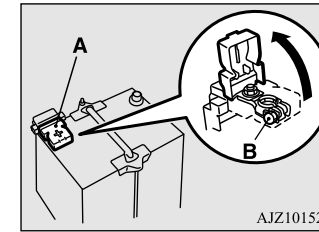

Tires

WARNING

- **Open doors and windows in any closed space where you may be charging or working with the 12V starter battery.**
- **Always wear protective clothing and goggles when working with the 12V starter battery, or have a skilled automobile technician do it.**
- **If you are quick-charging your 12V starter battery, first disconnect the 12V starter battery cables.**
- **In order to prevent a short circuit, be sure to disconnect the negative (-) terminal first, and reconnect it last.**
- **If the electrolyte level is very low, have the 12V starter battery checked at a certified i-MiEV dealer.**
- **12V starter battery terminals and related accessories contain lead and lead compounds. Wash hands after handling.**

CAUTION

- When replacing the 12V starter battery, remove the connected positive (+) and negative (-) terminals after turning the electric motor switch to the “LOCK” position and waiting at least 1 minute. If the 12V starter battery terminal is removed just after the electric motor switch is turned to the “LOCK” position, this may cause damage to components of the electric motor unit.

NOTE

- Before cleaning the 12V starter battery, tighten all the filler port caps to keep dirt and moisture out.
- Check each 12V starter battery terminal for corrosion. If necessary, clean the terminals with a solution of baking soda and water. Grease the posts and clamps after cleaning or tightening them.
- Check to see that the 12V starter battery is securely installed and cannot be moved. Also check each terminal for tightness.
- If you will not be driving your vehicle for a long period of time, remove the 12V starter battery and store it in a place where the 12V starter battery fluid will not freeze. Memory data for settings made by the user may be erased when the 12V starter battery is removed. If this happens, reset the settings again using the relevant procedures. The 12V starter battery only should be stored with a full charge.

Tires

N00939201619

WARNING

- **Driving with tires that are worn, damaged or improperly inflated is dangerous. These type tire conditions will adversely affect vehicle performance. These type tire conditions can also cause a tread separation or blowout which may result in an accident causing serious injury or death.**
- **Tires degrade over time with age even when they are not being used. It is recommended that tires over 6 years generally be replaced even if damage is not obvious.**

It is important to familiarize yourself with the following terms:

- Cold tire pressure:
 - The measured pressure after the vehicle has been parked for at least three hours, or
 - The measured pressure when the vehicle is driven less than 1 mile (1.6 km) after having been parked for three hours.
- Maximum inflation pressure: the maximum permissible cold tire inflation pressure for this tire.
- Recommended inflation pressure: the inflation pressure for optimum tire performance.

- Intended outboard sidewall:
 - The sidewall that contains a whitewall, bears white lettering or bears manufacturer, brand, and/or model name molding that is higher or deeper than the same molding on the other sidewall of the tire, or
 - The outward facing sidewall of an asymmetrical tire that has a particular side that must always face outward when mounted on a vehicle.
- Passenger car tire: a tire intended for use on passenger cars, multipurpose passenger vehicles, and trucks, that have a gross vehicle weight rating (GVWR) of 10,000 pounds or less.
- Light truck (LT) tire: a tire designated by its manufacturer as primarily intended for use on lightweight trucks or multipurpose passenger vehicles.
- Tread: portion of a tire that comes into contact with the road.
- Tread rib: a tread section running circumferentially around a tire.
- Tread separation: pulling away of the tread from the tire carcass.
- Carcass: the tire structure, except tread and sidewall rubber which, when inflated, bears the load.
- Sidewall: portion of a tire between the tread and bead.

- Section width: the linear distance between the exteriors of the sidewalls of an inflated tire, excluding elevations due to labeling, decoration, or protective bands.
- Bead: the part of the tire that is made of steel wires, wrapped or reinforced by ply cords and that is shaped to fit the rim.
- Ply: a layer of rubber-coated parallel cords.
- Cord: the strands forming the plies in the tire.
- Rim: a metal support for a tire or a tire and tube assembly upon which the tire beads are seated.
- Rim diameter: nominal diameter of the bead seat.
- Groove: the space between two adjacent tread ribs.

Tire Markings

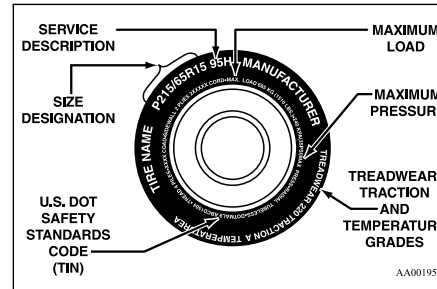

Size Designation

EXAMPLE:P215/65R15

P	Passenger car tire size based on U.S.A. design standards
215	Section width in millimeters (mm.)
65	Aspect ratio in percent (%) Ratio of section height to section width of tire.
R	Construction code • "R" means radial construction. • "D" means diagonal or bias construction.
15	Rim diameter in inches (in)

Tires

 **NOTE**

- European/Japanese metric tire sizing is based on European/Japanese design standards. Tires designed to these standards have the tire size molded into the sidewall beginning with the section width. The letter “P” is absent from this tire size designation. Example: 215/65R15 96H.
- LT (Light Truck) -metric tire sizing is based on U.S.A. design standards. The size designation for LT-metric tires is the same as for P-metric tires except for the letters “LT” that are molded into the sidewall preceding the size designation. Example: LT235/85R16.

9

Service Description

EXAMPLE: 95H

95	<p>Load index A numerical code associated with the maximum load a tire can carry.</p>
H	<p>Speed symbol A symbol indicating the range of speeds at which a tire can carry a load corresponding to its load index under certain operating conditions.</p> <p>The maximum speed corresponding to the speed symbol should only be achieved under specified operating conditions. (i.e. tire pressure, vehicle loading, road conditions and posted speed limits)</p>

Maximum Load

Maximum load indicates the maximum load this tire is designed to carry.

 **WARNING**

- **Overloading of your tire is dangerous. Overloading can cause tire failure, affect vehicle handling, and increase your stopping distance. Use tires of the recommended load capacity for your vehicle. Never overload them.**

Maximum Pressure

Maximum Pressure indicates the maximum permissible cold tire inflation pressure for this tire.

Tire Identification Number (TIN)

The TIN may be found on one or both sides of the tire but the date

code may only be on one side. Look for the TIN on the outboard side of tires as mounted on the vehicle. If the TIN is not found on the outboard side then you will find it on the inboard side of the tire.

EXAMPLE: DOT MA L9 ABCD 1504

DOT	Department of Transportation This symbol certifies that the tire is in compliance with the U.S. Department of Transportation tire safety standards, and is approved for highway use.
MA	Code representing the tire manufacturing location. (2 digits)
L9 ABCD	Code representing the tire size. (2 digits) Code used by tire manufacturer. (1 to 4 digits)
15	Number representing the week in which the tire was manufactured. (2 digits)

04	Number representing the year in which the tire was manufactured. (2 digits)
----	---

Treadwear, Traction and Temperature Grades

Treadwear

The treadwear grade is a comparative rating based on the wear rate of the tire when tested under controlled conditions on a specified government test course. For example, a tire graded 150 would wear one and one-half (1½) times as well on the government course as a tire graded 100. The relative performance of tires depends upon the actual conditions of their use, however, and may depart significantly from the norm due to variations in driving habits, service practices and differences in road characteristics and climate.

Traction

The traction grades, from highest to lowest, are AA, A, B and C. Those grades represent the tire's ability to stop on wet pavement as measured under controlled conditions on specified government test surfaces of asphalt

and concrete. A tire marked C may have poor traction performance.

Temperature

The temperature grades are A (the highest), B and C, representing the tire's resistance to the generation of heat and its ability to dissipate heat when tested under controlled conditions on a specified indoor laboratory test wheel. Sustained high temperature can cause the material of the tire to degenerate and reduce tire life, and excessive temperature can lead to sudden tire failure. The grade C corresponds to a level of performance which all passenger car tires must meet under the Federal Motor Vehicle Safety Standard No. 109. Grades B and A represent higher levels of performance on the laboratory test wheel than the minimum required by law.

9

Tire inflation pressures

N00939300873

Proper tire inflation pressure is essential for the safe and satisfactory operation of your vehicle. The wrong tire pressure will cause problems in three major areas:

- Safety

Tires

Too little pressure increases flexing in the tire and can cause tire failure. Too much pressure can cause a tire to lose its ability to cushion shock. Objects on the road and potholes could then cause tire damage that may result in tire failure.

- **Economy**

The wrong tire pressure can cause uneven wear patterns in the tire tread. These abnormal wear patterns will reduce the tread life, and the tire will have to be replaced sooner.

Too little pressure also makes it harder for the tire to roll, and this uses up more power.

- **Ride comfort and vehicle stability**

The superior riding experience built into your vehicle partly depends on the correct tire pressure. Too much pressure gives an uncomfortable and jarring ride. Too little pressure feels as if your vehicle is slow to respond.

Unequal tire pressures can make steering your vehicle uneven and unpredictable.

The correct tire pressure for your vehicle is listed on the placard attached to the sill of the driver's door.

(Refer to "Tire and loading information placard" on page 11-3.)

The recommended inflation pressures should be used for the tires listed below.

Tire size	Front	Rear
145/65R15 72H	250 KPA, 36 PSI	—
175/60R15 81H	—	250 KPA, 36 PSI

Tire pressures should be checked, and adjusted if necessary, at least once a month. Pressures should be checked more often whenever weather temperatures change severely, because tire pressures change with outdoor temperatures. The pressures listed on the placard are always "cold inflation pressure".

Cold inflation pressure is measured after the vehicle has been parked for at least three hours or is driven less than 1 mile (1.6 km) after having been parked for three hours.

Cold inflation pressure must not go above the maximum values molded into the tire sidewall. After driving several miles, your tire inflation pressure may increase 14 to 41 KPA, 2 to 6 PSI from the cold inflation pressure. Do not let air out of the tires to get back to the specified cold pressure, or your tire pressure will be too low.

You should also take the following safety precautions:

- Keep your tires inflated to the recommended pressures. (See the tire and loading information placard attached to the sill of the driver's door.)
- Stay within the recommended load limits.
- Make sure that the weight of any load in your vehicle is evenly distributed.
- Drive at safe speeds.
- After filling your tires to the correct pressure, check them for damage and air leaks. Be sure to reinstall the caps on the valve stems.

Replacing tires and wheels

N00939600427

CAUTION

- Avoid using different size tires and wheels from the ones listed, and avoid the combined use of different types of tires and wheels. Using different size or type tires and wheels may affect driving safety. Refer to "Tires and wheels" on page 11-6.
- Even if a wheel has the same rim size and offset as the specified type of wheel, its shape may prevent it from being fitted correctly. Consult a certified i-MiEV dealer before using wheels that you have.

CAUTION

- Only Mitsubishi Motors genuine wheels should be used, because your vehicle is equipped with a tire pressure monitoring system. Use of another type of wheel risks air leaks and sensor damage, as it will not be possible to install the tire pressure sensor properly.

Tire maintenance

N00939700170

The following maintenance steps are recommended:

- Check tire pressures regularly.
- Have regular maintenance done on the wheel balance and front and rear suspension alignment.

Tread wear indicators

N00939800214

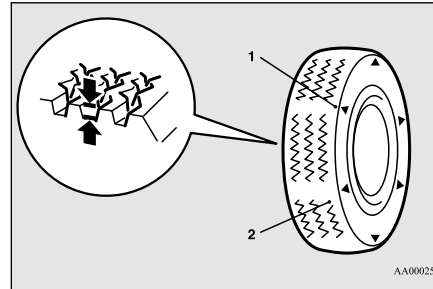

- 1- Location of the tread wear indicator
- 2- Tread wear indicator

Tread wear indicators are built into the original equipment tires on your vehicle to help you know when your tires should be replaced. Many states have laws requiring that you replace your tires at this point.

These indicators are molded into the bottom of the tread grooves and will appear when the tire tread is worn down to 1/16 inch (1.6 mm).

When the bands appear next to one another in two or more places, replace your tires.

NOTE

- Tire wear indicators can have different marks and locations depending on the tire manufacturer.

Tire rotation

N00939900518

Because the front and rear tires and wheels are not the same size, do not rotate the front and rear tires.

WARNING

- Rotating tires would compromise the stability and drivability of the vehicle and could lead to a serious accident.

Snow tires

N00940000359

In some areas of the country, snow tires are required for winter driving. If snow tires are required in your area, you must choose snow tires of the same size and type as the original tires provided with your vehicle. Snow tires should also be installed on all four wheels. Otherwise your safety and vehicle handling can be reduced.

Even where laws may permit it, snow tires should not be operated at sustained speeds over 75 mph (120 km/h).

CAUTION

- If flange nuts are used on your vehicle, change to tapered nuts when using snow tires with steel wheels.

Brake pedal free play

⚠ CAUTION

- Only Mitsubishi Motors genuine wheels should be used, because your vehicle is equipped with a tire pressure monitoring system. Use of another type of wheel risks air leaks and sensor damage, as it will not be possible to install the tire pressure sensor properly.

Tire chains

N00940100129

⚠ CAUTION

- Tire chains cannot be used on your vehicle. The clearance between the chains and the body is not sufficient to allow proper clearance, and the vehicle body might be damaged.

9

Brake pedal free play

N00940300310

To check the brake pedal free play (A), turn off the electric motor unit and press the brake pedal several times with your foot. Then press the pedal down with your fingers until you first feel resistance.

Brake pedal free play:
.1 to .3 inch (3 to 8 mm)

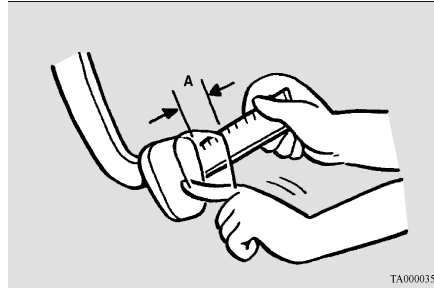

TA0000355

If the free play is not within these limits, take your vehicle to a certified i-MiEV dealer for adjustment.

Parking brake lever stroke

N00940400236

Check the parking brake lever travel occasionally. To check this, pull the lever up slowly and count the number of clicks of the ratchet.

Parking brake lever stroke:
6 to 7 notches

Also check to see if the lever stays gripped by the ratchet after pulling.

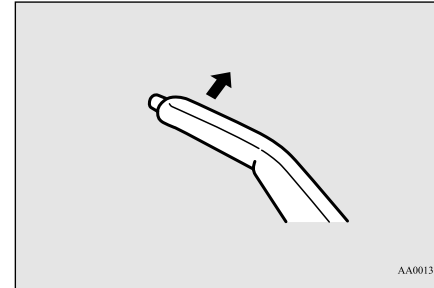

AA0013839

⚠ WARNING

- Continued operation of the vehicle with the parking brake lever out of adjustment may result in the vehicle moving when unattended.

Wiper blades

N00940701210

Check the wiper blades occasionally. Clean them regularly to remove deposits of salt and road film. Use a sponge or cloth and a mild detergent or non-abrasive cleaner to clean the blades and glass areas. Replace the blades if they continue to streak or smear.

General maintenance

NOTE

- Do not run the wipers on dry glass for a long time. This wears out the rubber and can scratch the glass.

During cold weather

If the blades are frozen to the windshield or rear window, do not operate the wipers until the ice has melted and the blades are freed, otherwise the wiper motor may be damaged.

NOTE

- When replacing front wiper blade assembly with a wiper blade for use in cold regions, it is necessary to adjust the washer nozzle (A) spray positions. Always contact a certified i-MiEV dealer when replacing front wiper blade with a wiper blade for use in cold regions.
- When removing snow and frost, be careful not to damage the washer nozzle which are attached to the wiper arm.

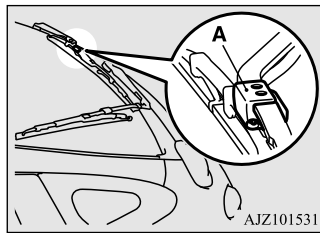
**General maintenance**

N00941500289

The next pages list the maintenance service recommended by Mitsubishi Motors Corporation. In addition to the general maintenance that needs to be performed at the times listed, there are other parts which do not usually need regular maintenance.

But, if any of these parts stops working properly, your vehicle performance could suffer. Have these items checked if you notice a problem with them.

See a certified i-MiEV dealer for assistance, if you have any questions.

Disc brake pads, rear drum brake linings and rear wheel cylinders

N00941600033

Good brakes are essential to safe driving. Check the brake pads and brake linings for wear and check the rear wheel cylinders for leaks. For good braking performance, replace the brake pads with the same type pads as the originals.

Brake hoses

N00941700047

Brake hoses and tubing should be checked for:

- Severe surface cracking, scuffing or worn spots. If the fabric casing of the hose is showing through any cracks or worn spots in the rubber hose cover, the hose should be replaced. The brakes can fail if the hose wears through.
- Improper installation may cause twisting, or wheel, tire or chassis interference.

Ball joint, steering linkage seals and drive shaft boots

N00941800077

Check the following parts for damage and grease leaks:

- Ball joint boots of the front suspension and steering linkage
- Bellows on both ends of the drive shaft

Hood lock release mechanism and safety catch

N00942500114

The hood lock release mechanism and hood safety catch should be checked, cleaned, and oiled when needed for easy movement and to



For cold and snowy weather

stop rust and wear. Use Multipurpose Grease NLGI Grade 2 sparingly for all sliding parts of the hood latch and release lever. Work the grease into the hood lock mechanism until all the movable surfaces are covered.

Also, put a light coat of the same grease on the safety catch wherever moving parts touch.

For cold and snowy weather

N00942600131

Ventilation slots

9

The ventilation slots in front of the windshield should be brushed clear after a heavy snowfall so that the operation of the heating and ventilation systems will not be impaired.

Weatherstripping

To prevent freezing of the weatherstripping on the doors, hood, etc., they should be treated with silicone grease.



Additional equipment (For regions where snow is encountered)

It is a good idea to carry a shovel or a short-handled spade in the vehicle during the winter so that you can clear away snow if you get stranded. A small hand-brush for sweeping snow off the vehicle and a plastic scraper for the windshield, side and rear window are also useful.

Fusible links

N00942700321

The fusible links will melt to prevent a fire if a large current attempts to flow through certain electrical systems.

In case of a melted fusible link, see a certified i-MiEV dealer for inspection and replacement.

For the fusible links, please refer to “Fuse load capacities” on page 9-19.

WARNING

- **Fusible links must not be replaced by any other device. Failing to fit the correct fusible link may result in fire in the vehicle, property destruction and serious or fatal injuries at any time.**

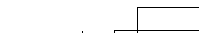
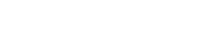
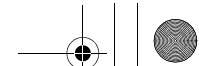
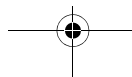

Fuses

N00942800885

Fuse block location

N00901000107

To prevent damage to the electrical system from short-circuiting or overloading, each individual circuit is equipped with a fuse. The fuse blocks are located in the passenger compartment and in under the hood.

NOTE

- Spare fuses are not provided. Please purchase from a certified i-MiEV dealer.

Passenger compartment

The fuse block in the passenger compartment is located in front of the driver's seat at the position shown in the illustration. Press the tab (A) and remove the fuse cover (B).

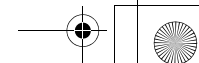

Fuses

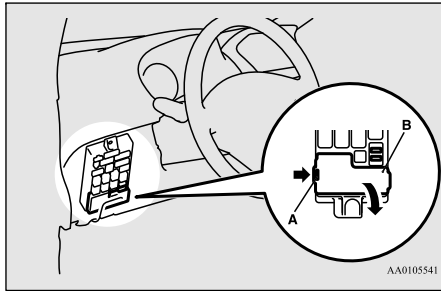

AA0105541

Fuse load capacities

N00954801313

This fuse list shows the names of the electrical systems and their fuse capacities. Always replace a blown fuse with one of the same capacity as the original.

Passenger compartment fuse location table

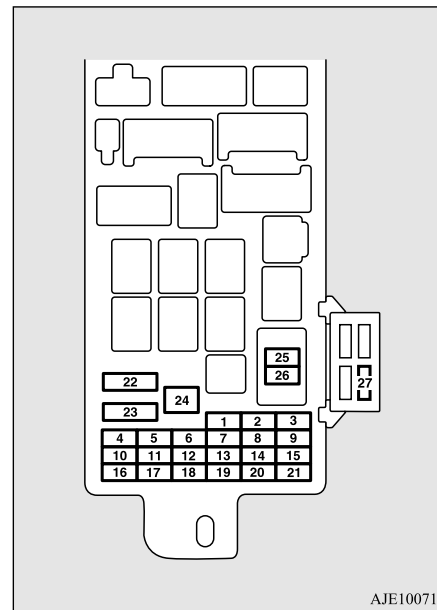

AJE100713

Under the hood

Under the hood, the fuse block is located as shown in the illustration. Press the tab (A) and remove the cover.

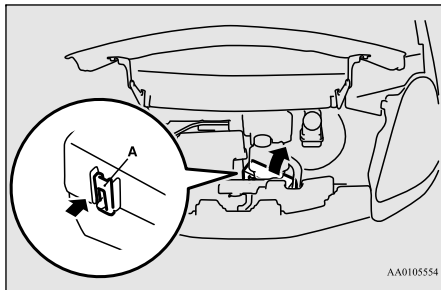

AA0105554

No.	Symbol	Electrical system	Capacity
1		Tail light (left)	7.5 A
2		Cigarette lighter/ 12 V power outlet	15 A
3	—	—	—
4		Starter	7.5 A
5		Audio amplifier	20 A
6	—	—	—
7		Tail light (right)	7.5 A
8		Outside rearview mirrors	7.5 A
9		Control unit (Electric motor unit)	7.5 A
10		Control unit	7.5 A
11		Rear fog light	10 A
12		Door lock	15 A
13		Interior lights (Dome lights)	10 A
14		Rear window wiper	15 A
15		Gauges	7.5 A
16		Relay	7.5 A
17		Heated seat	20 A

Fuses

No.	Symbol	Electrical system	Capacity
18	OPTION	Option	10 A
19		Heated outside rear-view mirrors	7.5 A
20		Windshield wiper	20 A
21		Back-up lights	7.5 A
22		Defogger	30 A
23		Heater	30 A
24		12V starter battery	30 A*
25		Radio	10 A
26		Electronic controlled unit	15 A
27	—	Electronic controlled unit	7.5 A

*: Fusible link

- Some fuses may not be installed on your vehicle, depending on the vehicle model or specifications.
- The table above shows the main equipment corresponding to each fuse.

Under the hood fuse location table

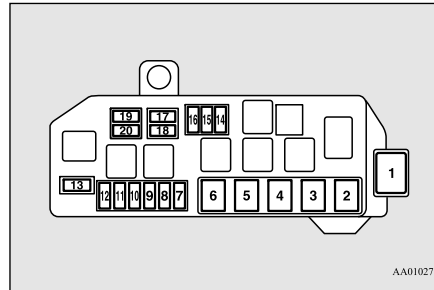

No.	Symbol	Electrical system	Capacity
1	—	—	—
2		12V starter battery	30 A*
3		Electric motor switch	40 A*
4		Radiator fan motor	40 A*
5		Power window control	40 A*
6		Brake electric vacuum pump	30 A*
7		Electric motor unit control	15 A
8	STOP	Stop lights (Brake lights)	15 A

No.	Symbol	Electrical system	Capacity
9		Front fog lights	15 A
10		Water pump (Electric motor unit)	15 A
11		Charge	10 A
12		Hazard warning flasher	10 A
13		Horn	10 A
14		Daytime running lights	10 A
15		Main drive lithium-ion battery fan motor	15 A
16		Water pump (Air conditioning)	10 A
17		Headlight (low beam) (right)	20 A
18		Headlight (low beam) (left)	20 A
19		Headlight (high beam) (right)	10 A
20		Headlight (high beam) (left)	10 A

*: Fusible link

9

- Some fuses may not be installed on your vehicle, depending on the vehicle model or specifications.
- The table above shows the main equipment corresponding to each fuse.

Identification of fuse

N00901100078

Capacity	Color
7.5 A	Brown
10 A	Red
15 A	Blue
20 A	Yellow
30 A	Green (fuse type) /Pink (fusible link type)
40 A	Green (fusible link type)

Fuse replacement

N00954900115

1. Before replacing a fuse, always turn off the electrical item connected to the fuse and turn the electric motor switch to the "LOCK" position.
2. Remove the fuse puller (A) from the inside of the fuse cover in the passenger compartment.

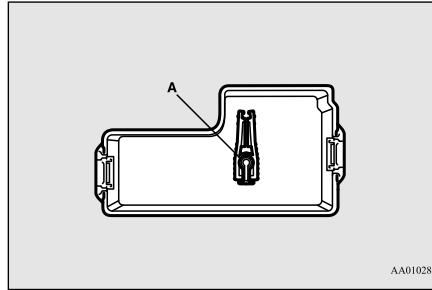

3. Clamp it on the fuse you wish to remove, and pull the fuse straight out from the fuse block.

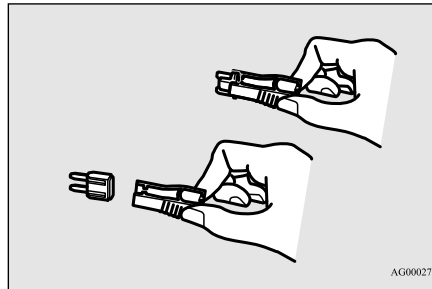

4. Use the fuse location diagrams and their corresponding tables, to check the fuse that is related to the problem. If the fuse is not blown, something else must be causing the problem. Contact a certified i-MiEV dealer to have the problem checked.

Replacement of light bulbs

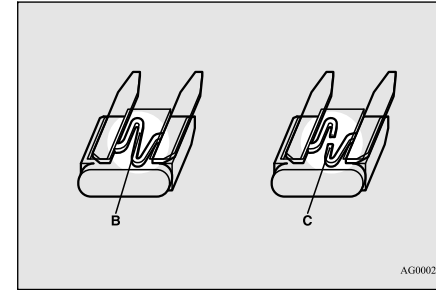

- B- Fuse is OK
- C- Blown fuse

5. Insert a new fuse of the same capacity securely into the appropriate slot.

CAUTION

- Never use a fuse with a capacity greater than the one listed or any substitute, such as wire, foil etc. This would cause the circuit wiring to heat up and could cause a fire.
- If the replacement fuse blows again after a short time, have the electrical system checked by a certified i-MiEV dealer to find and correct the cause.

Replacement of light bulbs

N00942900336

Before replacing a bulb, be sure the light is off. Do not touch the glass part of the new

Replacement of light bulbs

bulb with your bare fingers; the oil from your skin will stay on the glass and dim or destroy the bulb when it gets hot.

CAUTION

- Bulbs are extremely hot immediately after being turned off.
When replacing a bulb, wait for it to cool sufficiently before touching it. You could otherwise be burned.

NOTE

- 9**
- If you are unsure of how to carry out the work as required, it is recommended that these procedures be carried out by a certified i-MiEV dealer.
 - Be careful not to scratch the vehicle body when removing a light and lens.
 - When it rains, or when the vehicle has been washed, the inside of the lens sometimes becomes temporarily foggy. This is the same phenomenon as when window glass mists up on a humid day, and does not indicate a functional problem.
When the light is switched on, the heat will remove the fog. However, if water collects inside the light, please have it checked by a certified i-MiEV dealer.

Bulb capacity

N0094300099

The bulb should only be replaced with a new bulb with the same rating and type. The type and rating are listed on the base of the bulb.

Outside

N00950301916

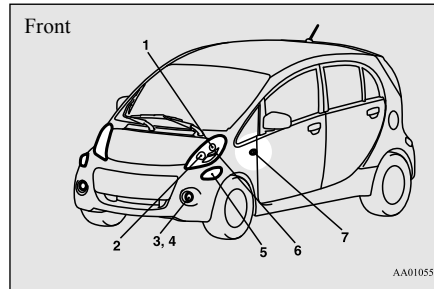

Description	Wattage	ANSI Trade No. or Bulb type
1- Headlight, low beam	55 W	H11
2- Head light, high beam	60 W	9005 HB3
3- Front fog light	35 W	H8

Description	Wattage	ANSI Trade No. or Bulb type
4- Daytime running light	13 W	P13W
5- Front turn signal light	21 W	W21W
6- Parking light	5 W	W5W
7- Front side-marker light	5 W	W5W

NOTE

- Check with a certified i-MiEV dealer when the headlight and the parking light need to be repaired or replaced.

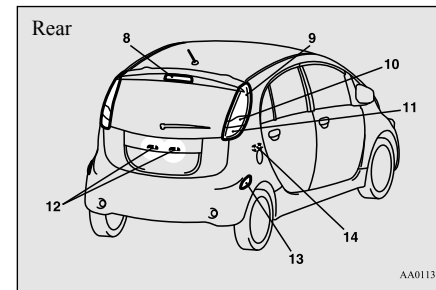

Replacement of light bulbs

Description	Wattage	ANSI Trade No. or Bulb type
8- High-mounted stop light	5 W	W5W
9- Tail and stop light	—	—
10- Rear turn signal light	21 W	WY21W
11- Back-up light	21 W	W21W
12- License plate light	5 W	W5W
13- Rear side-marker light	5 W	W5W
14- Regular charge port light	—	—

NOTE

- The tail and stop lights along with the regular charge port light use LEDs rather than bulbs. For repair and replacement, contact a certified i-MiEV dealer.

Inside

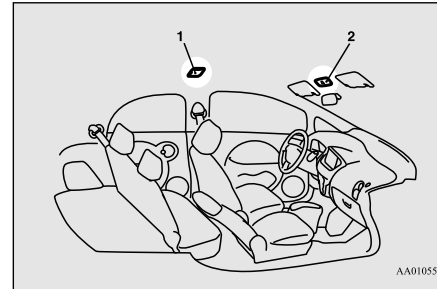

Description	Wattage
1- Dome light (Rear)	8 W
2- Dome light (Front)/Reading lights	8 W

Adjustment of headlight aim

N00943200349

The alignment of the headlights should be checked by a certified i-MiEV dealer.

Front side-marker lights

N00915501184

1. Insert a flat blade screwdriver into the end of the light nearer the rear of the body and pry gently to remove the light.

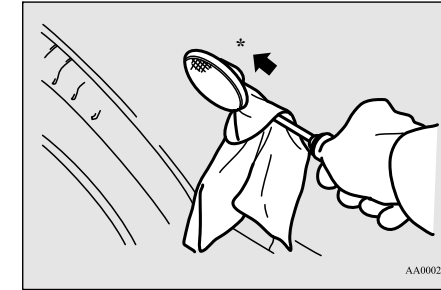

*: Front of the vehicle

NOTE

- Wrap a cloth around the tip of the screwdriver to keep from scratching the lens.

2. Remove the socket and bulb assembly together by turning it counterclockwise.

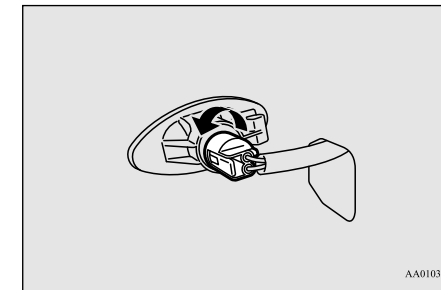

3. Pull the bulb out of the socket.

Replacement of light bulbs

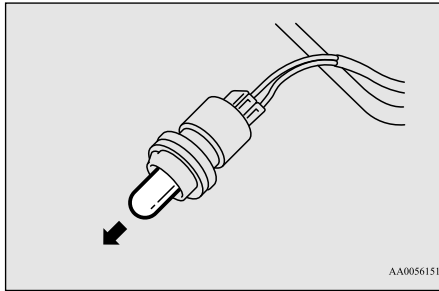

4. To install the bulb, perform the removal steps in reverse.

9

NOTE

● When installing the light assembly, push in the end facing the front of the vehicle first.

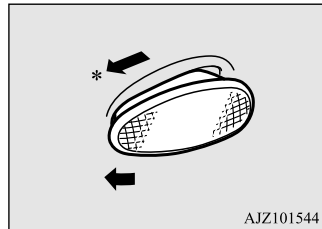

*: Front of the vehicle

Front turn signal lights/Front fog lights/Daytime running lights

N00943401407

1. To create enough work space, turn the steering wheel all the way in the same direction to the side you wish to replace.
2. Remove the clip (A) and bolts (B), then lift the cover (C).

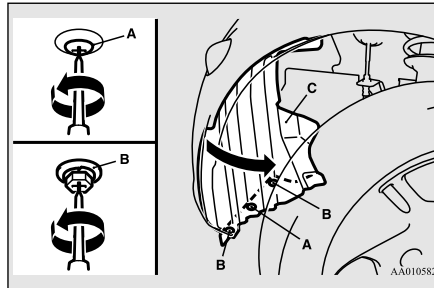

3. Turn the socket counterclockwise to remove it.

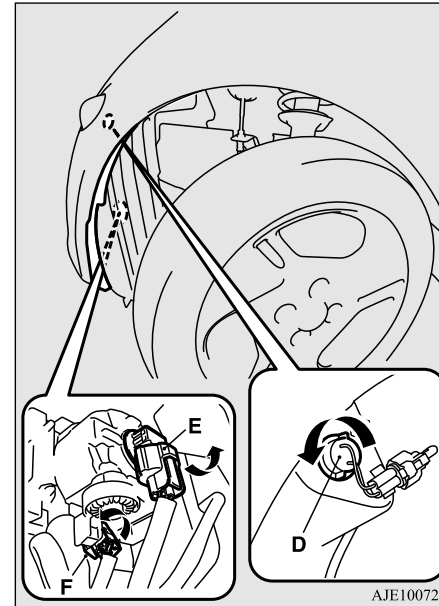

- D- Front turn signal light
- E- Front fog light
- F- Daytime running light

4. Remove the bulb as follows.
 - [Front turn signal light]
Pull the bulb out of the socket.
 - [Front fog light and daytime running light]
While holding down the tab (G), pull out the bulb assembly (H).

Replacement of light bulbs

Front turn signal light

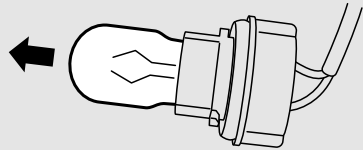

Front fog light

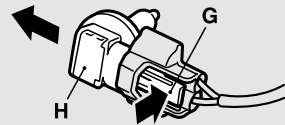

Daytime running light

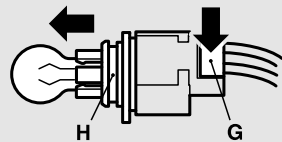

AJE100739

5. To install the bulb, perform the removal steps in reverse.

CAUTION

- Handle halogen light bulb with care. The gas inside a halogen light bulb is highly pressurized, so dropping, knocking, or scratching a halogen light bulb can cause it to shatter.

CAUTION

- Never hold the halogen light bulb with a bare hand, dirty glove, etc. The oil from your hand could cause the bulb to break the next time the fog lights are used. If the glass surface is dirty, clean it with alcohol and let it dry completely before installing the bulb.

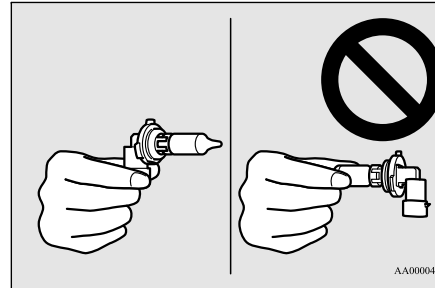

AA0000473

Rear combination lights

N00943700487

1. Open the liftgate.
(Refer to "Liftgate" on page 5-11.)
2. Remove the screws (A) that hold the light unit and remove the light unit.

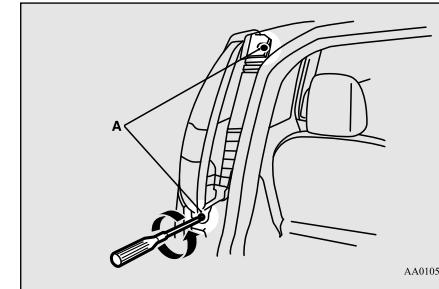

AA0105831

3. Move the light unit toward the rear of the vehicle and remove the pins (B) of the light unit from the vehicle.

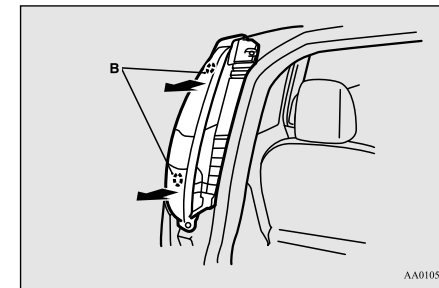

AA0105844

4. Turn the socket counterclockwise to remove it.

9

Replacement of light bulbs

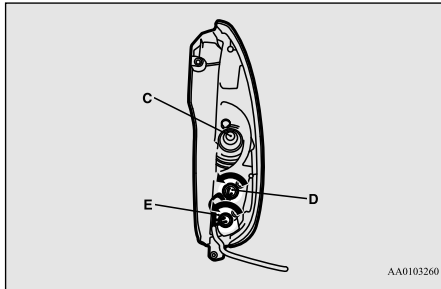

- C- Tail and stop light (LED) - cannot be replaced
- D- Rear turn signal light
- E- Back up light

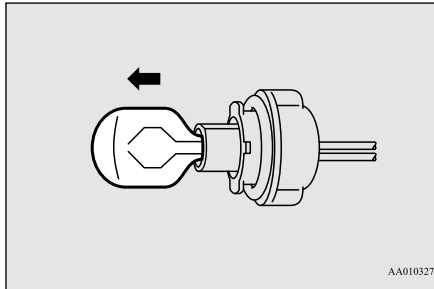

6. To install the bulb, perform the removal steps in reverse.

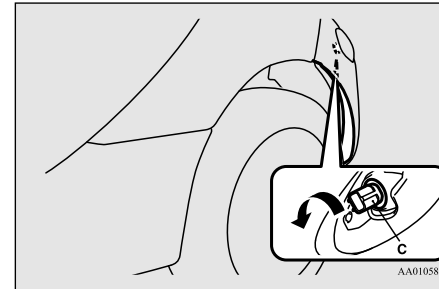

3. Pull the bulb out of the socket.

9

NOTE

- The tail and stop lights use LEDs rather than bulbs. For repair and replacement, contact a certified i-MiEV dealer.

5. Pull the bulb out of the socket.

Rear side-marker lights

N00935400108

1. Remove the clips (A), then lift the cover (B).

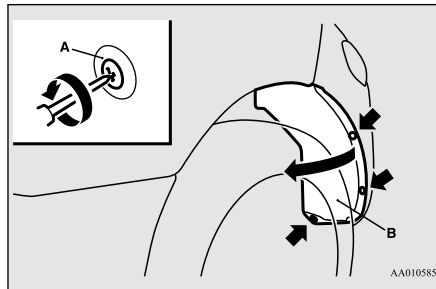

2. Turn the socket (C) counterclockwise to remove it.

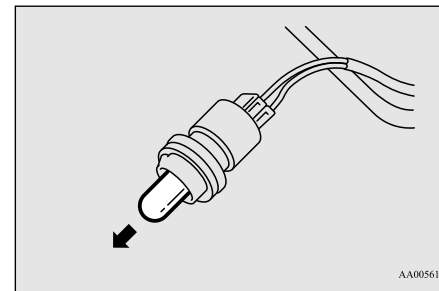

4. To install the bulb, perform the removal steps in reverse.

High-mounted stop light

N00943900128

1. Remove the mounting screws (A) and remove the light unit.

Replacement of light bulbs

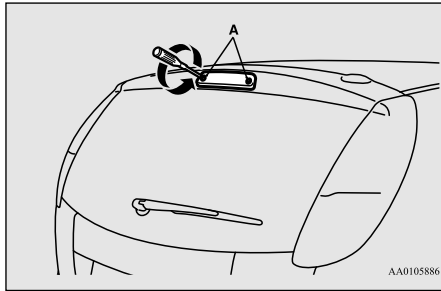

2. While holding down the tab (B), pull out the connector.

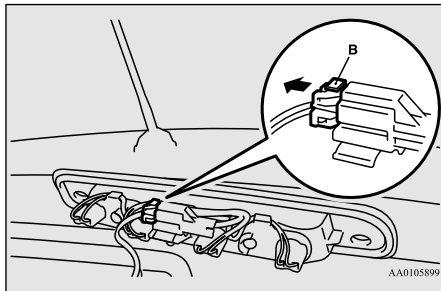

3. Remove the screws (C) and then remove the bulb holder.

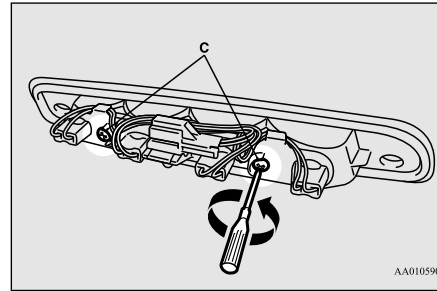

4. Pull the bulb out of the socket.

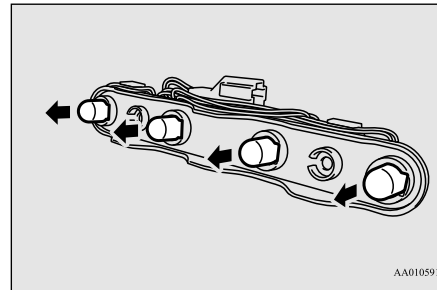

5. To install the bulb, perform the removal steps in reverse.

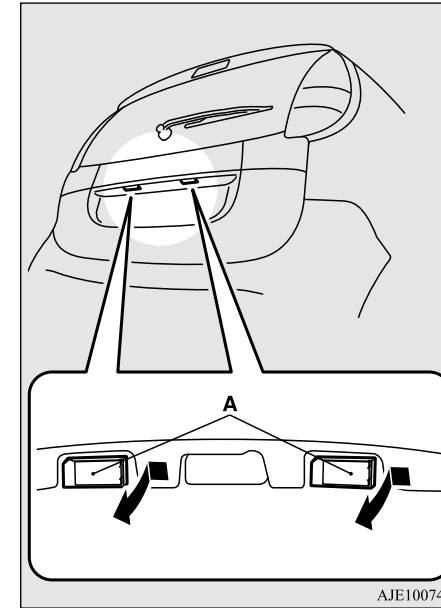

2. Use a flat blade screwdriver into the tab (B) and pry gently to remove the lens.

License plate lights

N00944001413

1. When removing the light unit (A), push it toward the left side of the vehicle body.

Vehicle care precautions

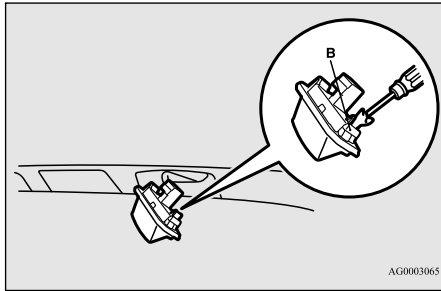

3. Pull the bulb out of the socket.

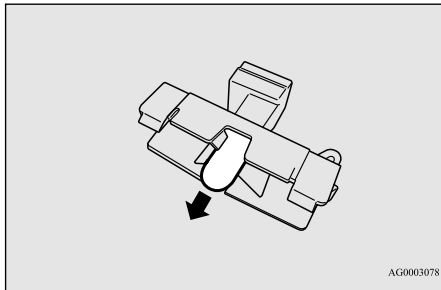

4. To install the bulb, perform the removal steps in reverse.

NOTE

- When installing the light, insert tab (C) first then align and insert tab (D).

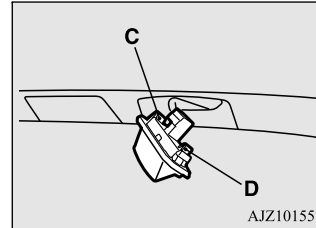

Vehicle care precautions

N00945100195

In order to maintain the value of your vehicle, perform regular maintenance using the proper materials and procedures. Be sure to use only those materials and procedures that meet your local environmental pollution control regulations. Choose the materials you will use carefully, to be sure that they do not contain corrosives. If you are not sure, contact a certified i-MiEV dealer for help in choosing these materials.

CAUTION

- Cleaning products can be dangerous. Some are poisonous. Others are highly flammable. Some are dangerous if you breathe their fumes in a closed space. When you use anything in a container to clean your vehicle, be sure to follow the instructions. Always open your vehicle doors or windows when you're cleaning the inside. Never use the following chemicals to clean your vehicle:

- Gasoline
- Carbon Tetrachloride
- Benzine
- Kerosene
- Naphtha
- Acetone
- Turpentine
- Paint Thinner
- Lacquer Thinner
- Nail Polish Remover

These can all be dangerous, and they all can damage your vehicle.

Cleaning the inside of your vehicle

N00945200079

After washing the inside of your vehicle with any cleaner, wipe it dry in a shady, well ventilated area.

CAUTION

- Do not use organic substances (solvents, benzine, kerosene, alcohol, gasoline, etc.) or alkaline or acidic solutions. These chemicals can cause discoloring, staining or cracking of the surface. If you use cleaners or polishing agents, make sure their ingredients do not include the substances mentioned above.

NOTE

- Always read the instructions on the cleaner label.

Plastic, vinyl leather, fabric and flocked parts

N00945300214

- Lightly wipe these off with a soft cloth soaked in a mild soap and water solution.
- Dip cloth in fresh water and wring out well. Using this cloth, wipe off the detergent thoroughly.

NOTE

- Do not use cleaners, conditioners, and protectants containing silicones or wax. Such products, when applied to the instrument panels or other parts, may cause reflections on the windshield and obscure vision. Also, if such products get on the switches of the electrical accessories, it may lead to failure of these accessories.

Upholstery

N00945500144

- To maintain the value of your new vehicle, maintain the upholstery carefully and keep the interior clean. Use a vacuum cleaner and brush to clean the seats. If stained, vinyl and synthetic leather should be cleaned with an appropriate cleaner. Cloth fabrics can be cleaned with either upholstery cleaner or a mild soap and water solution.
- Clean the carpeting with a vacuum cleaner and remove any stains with carpet cleaner. Oil and grease can be removed by lightly dabbing with a clean white cloth and spot remover.

NOTE

- If fuzzing is difficult to remove from the seat upholstery, draw a suitable defuzzing brush over the surface in one direction.

Cleaning the inside of your vehicle**Genuine leather (if so equipped)**

N00945600275

- To clean, lightly wipe the leather with a soft cloth soaked in a mild soap and water solution.
- To rinse, dip the cloth in fresh water, wring it out well, and wipe off all the soap.
- To preserve and protect, use a leather protecting agent on the genuine leather surface.

NOTE

- If genuine leather is wet with water, wipe it with a dry, soft cloth. If left damp, mildew may grow.
- The genuine leather surface can be damaged if brushed with a nylon or synthetic fiber brush.
- Organic solvents such as benzine, kerosene, alcohol, gasoline, acid or alkaline solvents can discolor the genuine leather surface and should not be used.
- The genuine leather surface may harden and shrink if it is exposed to the direct sunlight for long hours. When your vehicle is parked, place it in the shade as much as possible.

Cleaning the outside of your vehicle

Cleaning the outside of your vehicle

N00945700061

To protect your vehicle's finish, wash it often and thoroughly. If desired, you may wax your vehicle using a nonabrasive automobile wax.

Foreign material

N00945800046

Industrial pollution, road tar, bird droppings, tree sap, insect remains, sea water and other foreign matters can damage the finish on your vehicle.

Generally, the longer any foreign material stays on the finish, the worse the damage. Wash your vehicle as soon as possible whenever the finish gets soiled.

9

Washing

N00945900627

Chemicals contained in the dirt and dust picked up from air, rain, snow or road surfaces can damage the paint and body of your vehicle if left on.

Frequent washing and waxing is the best way to protect your vehicle from this damage.

Do not wash the vehicle in direct sunlight. Park the vehicle in the shade and spray it with water to remove dust. Next, using plenty of

clean water and a car washing mitt or sponge, wash the vehicle from top to bottom.

Use a mild car washing soap if necessary. Rinse thoroughly and wipe dry with a chamomise or soft cloth. After washing the vehicle, carefully clean the joints and flanges of the doors, hood, etc., where dirt is likely to remain.

WARNING

- **Do not wash the vehicle while charging the main drive lithium-ion battery. Doing so could cause a fire or an electric shock.**
- **Before washing the vehicle, make sure that the charging lid and the inner lid are completely closed. If the lid is open, the charging unit is exposed to water, resulting in a fire or an electric shock.**
- **Do not pour water inside the electric motor unit room. Doing so could cause a fire or an electric shock.**

CAUTION

- When washing the vehicle, turn the electric motor switch to the "LOCK" position.
- Do not use a high pressure washing machine to clean the underneath of the vehicle. Doing so might cause the electric motor unit problem or malfunction.

CAUTION

- When washing the underside of your vehicle or the wheels, wear a pair of gloves to protect your hands.
- Never spray or splash water on the electrical parts in under the hood. This may damage them. Be careful also when washing the underbody. Do not spray water up under the hood.
- Avoid automatic car washers that use rotating brushes. These brushes may scratch the paint surface and make it dull. Scratches are more noticeable on darker colored vehicles.
- Some hot water washing equipment uses high pressure and heat to clean your vehicle. This heated water may damage your vehicle's resin parts. It can flood the interior of the vehicle. Therefore, be sure of the following:
 - Keep the washing nozzle at least 28 inches (70 cm) away from the vehicle body.
 - When washing around the door glass, hold the nozzle at a distance of more than 28 inches (70 cm) and at right angles to the glass surface.
- Make sure to do the following when using an automatic car wash, with help from either this manual or the car wash operator, to avoid damaging your vehicle:
 - Fold the outside mirrors.
 - Remove the antenna.
 - Tape the wiper arm assembly.

During cold weather

Salt and other chemicals spread on winter roads in some geographical areas can have a detrimental effect on the vehicle underbody. You should flush the underbody with a high pressure hose every time you wash the outside of your vehicle.

Take special care to remove mud or other debris which could trap and hold salt and moisture.

After washing your vehicle, wipe off all waterdrops from the rubber parts around the doors to prevent the doors from freezing.

NOTE

- When the door is frozen, opening it by force may tear off or crack the rubber gasket installed around the door. Pour warm water to melt the ice. Be sure to thoroughly wipe off the water after opening the door. To prevent freezing of the weatherstripping on the doors, hood, etc., treat with silicone lubricant.

Waxing

N0094600247

Wax your vehicle once or twice a year, or when water does not bead up on the paint.

Use a soft cloth to put a small amount of wax on the painted surfaces. After the wax has dried, polish with a dry soft cloth.

Do not wax your vehicle in direct sunlight.

You should wax when the painted surfaces are cool.

CAUTION

- Waxes containing high abrasive compounds should not be used. These waxes remove rust and stain effectively from the paintwork, but are harmful to the finish on the paint and the plate, because they also remove clearcoat. They are also harmful to other glossy surfaces such as the grille, trim, moldings, etc.
- Do not use gasoline, kerosene, benzene or paint thinners to remove road tar or other dirt from the vehicle surface.
- Do not put wax on the areas having black matte coating because it can cause uneven discoloration, patches, blurs, etc. If these get wax on them, wipe the wax off right away with a soft cloth and warm water.

Polishing

N00946100059

If painted surfaces have been severely damaged and lost their original luster and color tone, polish the surface lightly with a fine polishing compound. Avoid limiting your polishing to the damaged surface only; polish a somewhat wider area, moving the polishing

Cleaning the outside of your vehicle

cloth in one direction. After polishing, flush the compound from the surface and apply a coat of wax to regain a beautiful luster.

Damaged paint

N00946200089

Small cracks and scratches in the paint coat should be touched up as soon as possible with touch-up paint to prevent corrosion.

Check body areas facing the road or the tires carefully for damage to the paint caused by flying stones, etc. The paint code number for your vehicle can be found on the vehicle information code plate. Refer to “Vehicle information code plate” on page 11-2.

9

Cleaning plastic parts

N00946300211

Use a sponge or chamois to clean these parts. If a vehicle wax sticks to a gray or black rough surface of the bumper, molding or lights, the surface may appear white in color. In this case, wipe it off using lukewarm water and a soft cloth or chamois.

CAUTION

- Do not use a scrubbing brush or other rough scrubber as these may damage the plastic surface.

Cleaning the outside of your vehicle

CAUTION

- Do not use wax containing compounds (polishing powder) which may damage the plastic surface.
- Do not let the plastic parts get soiled with gasoline, oil, brake fluids, greases, paint thinner, and sulfuric acid (battery electrolyte). These fluids, etc., may crack, stain or discolor the plastic parts.
If any of these get on the plastic parts, wipe them up with a soft cloth or chamois and a mild solution of soap and water. Then rinse them immediately with water.

CAUTION

- Do not use a brush or other hard implement on the wheels.
Doing so could scratch the wheels.
- Do not use any cleaner that contains an abrasive substance or is acidic or alkaline. Doing so could cause the coating on the wheels to peel or become discolored or stained.
- Do not directly apply hot water using a steam cleaner or by any other means.
- Contact with seawater or road salt used for de-icing can cause corrosion. Rinse off such substances as soon as possible.

Under the hood

N00947000127

Never spray or splash water on the electrical components under the hood, as this may cause damage.

Do not allow any nearby parts (such as plastic parts) come into contact with sulphuric acid (12V starter battery electrolyte), which may crack, stain, or discolour them.

If this occurs, wipe the parts with a soft cloth saturated with a mild detergent and water solution.

Then immediately rinse the affected parts with plenty of water.

9 Chrome parts

N00946400065

To prevent spots and corrosion of chrome parts, wash with water, dry thoroughly, and apply a nonabrasive automotive wax. If the chrome is severely damaged or pitted, use a commercially available chrome polish.

Aluminum wheels

N00946500196

1. Remove dirt using a wet sponge.
2. Use a mild detergent on any dirt that cannot be removed easily with water.
Rinse off the detergent after washing the wheel.
3. Dry the wheel thoroughly using a chamois leather or a soft cloth.

Window glass

N00946600067

The window glass can usually be cleaned using only a sponge and water. Glass cleaner can be used to remove wax, oil, grease, dead insects, etc. After washing the glass, wipe it dry with a clean, dry, soft cloth.

Wiper blades

N00946700097

Use a soft cloth and glass cleaner to remove grease, dead insects, etc., from the wiper blades.

Replace the wiper blades when they no longer clean the windshield and rear window properly.

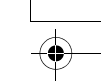
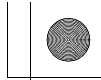
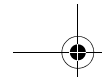
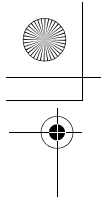

Customer assistance/Reporting Safety Defects

Consumer information (For vehicles sold in U.S.A.)	10-2
Reporting Safety Defects	10-2
Important facts to know in case of an accident	10-3

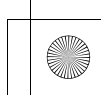
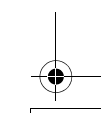
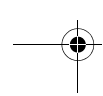
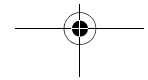
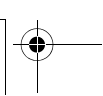
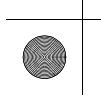
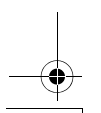
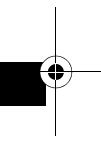
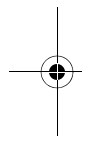



Consumer information (For vehicles sold in U.S.A.)

Consumer information (For vehicles sold in U.S.A.)

N01047100171

This information is provided in compliance with the requirements of the National Highway Traffic Safety Administration, Department of Transportation. It provides the purchasers and/or prospective purchasers with information on reporting safety defects.

Uniform tire quality grading

DOT quality grades - All passenger vehicle tires must conform to Federal Safety Requirements in addition to these grades. The specific grade rating in each grade category is shown on the side wall of the tires on your vehicle.

10

Treadwear

The treadwear grade is a comparative rating based on the wear rate of the tire when tested under controlled conditions on a specified government test course. For example, a tire graded 150 would wear one and one-half (1½) times as well on the government course as a tire graded 100. The relative performance of tires depends upon the actual conditions of



10-2 Customer assistance/Reporting Safety Defects



their use, however, and may depart significantly from the norm due to variations in driving habits, service practices and differences in road characteristics and climate.

Traction AA, A, B, C

The traction grades, from highest to lowest, are AA, A, B and C. Those grades represent the tire's ability to stop on wet pavement as measured under controlled conditions on specified government test surfaces of asphalt and concrete. A tire marked C may have poor traction performance.

WARNING

- The traction grade assigned to this tire is based on straight-ahead braking traction tests, and does not include acceleration, cornering, hydroplaning, or peak traction characteristics.

Temperature A, B, C

The temperature grades are A (the highest), B and C, representing the tire's resistance to the generation of heat and its ability to dissipate heat when tested under controlled conditions on a specified indoor laboratory test wheel. Sustained high temperature can cause the

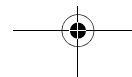

material of the tire to degenerate and reduce tire life, and excessive temperature can lead to sudden tire failure. The grade C corresponds to a level of performance which all passenger car tires must meet under the Federal Motor Vehicle Safety Standard No. 109. Grades B and A represent higher levels of performance on the laboratory test wheel than the minimum required by law.

WARNING

- The temperature grade for this tire is established for a tire that is properly inflated and not overloaded. Excessive speed, underinflation, or excessive loading, either separately or in combination, can cause heat buildup and possible tire failure.

Reporting Safety Defects

N01047201515

If you believe that your vehicle has a defect which could cause a crash or could cause injury or death, you should immediately inform the National Highway Traffic Safety Administration (NHTSA) in addition to notifying Mitsubishi Motors Corporation.

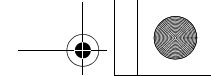

If NHTSA receives similar complaints, it may open an investigation, and if it finds that a safety defect exists in a group of vehicles, it may order a recall and remedy campaign. However, NHTSA cannot become involved in individual problems between you, your dealer, or Mitsubishi Motors Corporation.

To contact NHTSA, you may call the Vehicle Safety Hotline toll-free at 1-888-327-4236 (TTY: 1-800-424-9153); go to <http://www.safercar.gov>; or write to:

**NHTSA Headquarters
1200 New Jersey Avenue, SE
West Building
Washington, DC 20590**

You can also obtain other information about motor vehicle safety from <http://www.safercar.gov>.

For vehicles sold in U.S.A.

To contact Mitsubishi Motors North America, Inc. call 1-888-648-7820 or write to:

**Mitsubishi Motors North America, Inc.
Customer Relations Department
P.O. Box 6400
Cypress, CA 90630-0064**

For vehicles sold in Canada

If you live in Canada, and you believe that your vehicle has a safety defect, you should immediately notify Transport Canada, in addition to notifying Mitsubishi Motor Sales of Canada, Inc. You may write to:

**Transport Canada
330 Sparks Street
Tower C
Ottawa, Ontario K1A 0N5**

Important facts to know in case of an accident

To contact Mitsubishi Motor Sales of Canada, Inc. call 1-888-576-4878 or write to:

**Mitsubishi Motor Sales of Canada, Inc.
Customer Relations Department
P.O. Box 41009
4141 Dixie Road
Mississauga, ON L4W 5C9**

Important facts to know in case of an accident

N01047300098

10

We hope you will never be involved in an accident, but there is always that potential danger. So, please be sure to buckle up and drive safely.

In the event of an accident

- Remain calm.
- Check for injuries. Report all injuries to the police, and, if necessary, call for an ambulance.



Important facts to know in case of an accident

- Record all the details of the accident. This will provide you with accurate records of the accident for discussions with your insurance company and other persons who may be acting on your behalf.

Key information to discuss with your insurance company

- Understand your repair estimate before approving repairs.
- Choosing the repair shop and the brands of parts that they use on your vehicle is your decision.
- Ask for genuine Mitsubishi Motors parts. Many times, to save money, your insurance company will recommend imitation parts that do not meet the original specifications of fit, finish, corrosion resistance or workmanship.

10

Mitsubishi Motors built-in protection

The strength and integrity built into your Mitsubishi vehicle is the result of a specific design referred to as “Energy Management”. Individual body parts are designed to act as one unit in the event of an accident. Shock waves are absorbed by protective panels or are channeled around the passenger compart-

10-4 Customer assistance/Reporting Safety Defects



ment. This important feature is possible because high tensile steel is used in Mitsubishi panels and structural parts, something that cannot be guaranteed by the manufacturers of imitation parts. All Genuine Mitsubishi body panels and support brackets are designed and constructed as important protection features in the event of an accident. By replacing body parts with imitations, your vehicle may no longer meet original equipment specifications.

Consumer rights (For vehicles sold in U.S.A.)

As a consumer requesting repair on your vehicle, you have consumer rights. Across the country, State Insurance Commissioners have begun considering rules on the use of non-OEM parts. This could mean that repair shops will have to disclose to the consumer, when they intend to use non-OEM parts. Since regulations are not consistent on this point, remember you have a choice. So, if you want genuine Mitsubishi Motors parts, you may have to specifically request them. Make certain your insurance company understands imitations are not to be used in the repair of your vehicle. You deserve the best genuine Mitsubishi Motors parts.

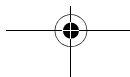

Genuine Mitsubishi Motors parts

Genuine Mitsubishi Motors parts are built with the high quality and durability standards you expect. Genuine Mitsubishi Motors replacements parts are your guarantee that your vehicle will have all the technological advantages and maintain the style and protection of a brand new Mitsubishi Motors. Remember to ask for genuine Mitsubishi Motors parts.

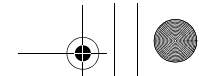

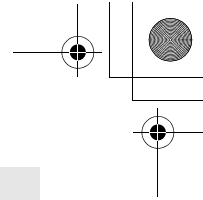
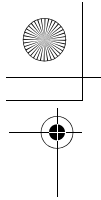

Specifications

Vehicle labeling	11-2
Vehicle dimensions	11-4
Vehicle weights	11-4
Charging system specifications	11-5
Electric motor specifications	11-6
12V starter battery	11-6
Tires and wheels	11-6
Refill capacities	11-7

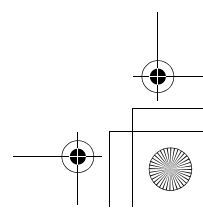
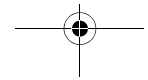
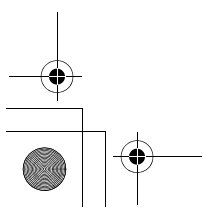
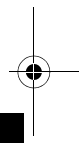
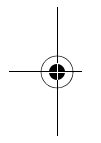

Vehicle labeling

Vehicle labeling

N01147400739

Keep a record of the chassis number and vehicle identification number. This information will assist the police if your vehicle is ever stolen.

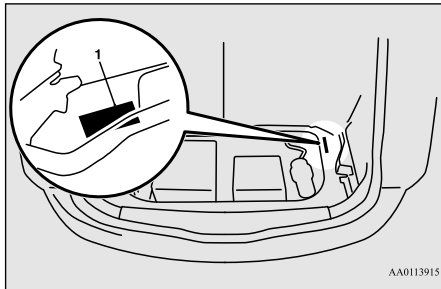

11

1 - Vehicle emission control information label

The vehicle emission control information label is affixed in the location shown in the illustration.

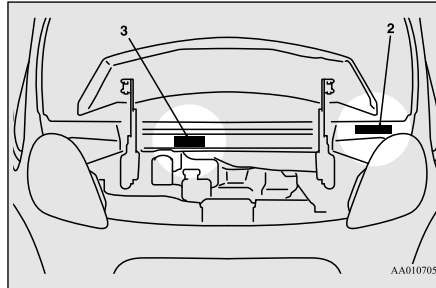

2 - Vehicle identification number plate

The vehicle identification number is stamped in the location shown in the illustration. It is visible from outside of the vehicle through the windshield.

3 - Air conditioning label

The air conditioning label is affixed on the bulkhead as shown in the illustration.

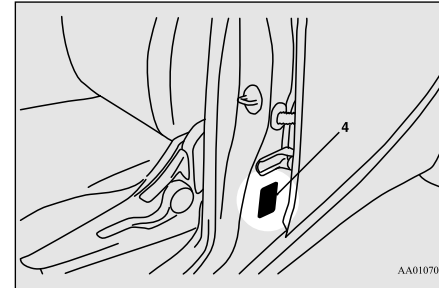

4 - Vehicle information code plate

The vehicle information code plate is located on the driver's door sill.

Chassis number

The chassis number is stamped behind the lid on the right side of the luggage room.

Vehicle labeling

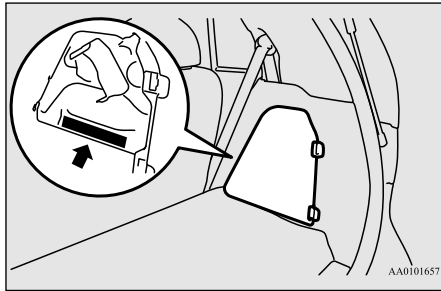

AA0101657

Tire and loading information placard

N01148100599

The tire and loading information placard is located on the driver's door sill.

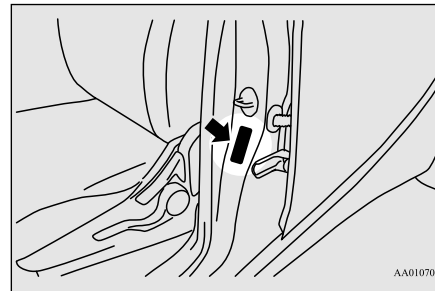

AA0107079

Electric motor number

The electric motor number is stamped on the cylinder block as shown in the illustration.

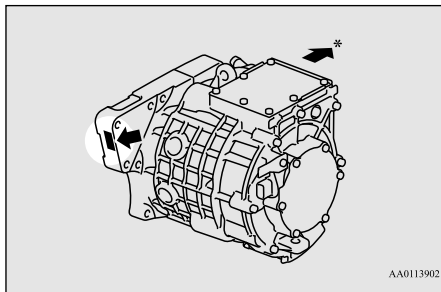

AA0113902

* - Front of the vehicle

Certification label

N01148200239

The certification label is located on the driver's door sill.

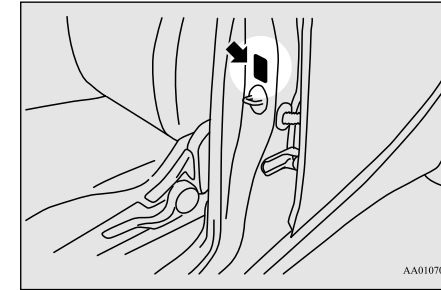

AA0107082

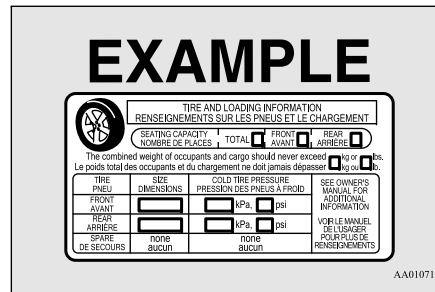

AA0107154

Vehicle dimensions

Vehicle dimensions

N01147501580

Overall length	144.7 in (3,675 mm)
Overall width	62.4 in (1,585 mm)
Overall height	63.6 in (1,615 mm)
Wheel base	100.4 in (2,550 mm)

Vehicle weights

N01147601943

Gross vehicle weight rating (GVWR)	3,329 lb (1,510 kg)	
Gross axle weight rating (GAWR)	Front	1,488 lb (675 kg)
	Rear	1,962 lb (890 kg)
Vehicle capacity weight	661 lb (300 kg)	
Seating capacity	4 persons	

11

GVWR: maximum total weight (load) limit specified for the vehicle
 GAWR: maximum weight (load) limit specified for the front or rear axle
 Seating capacity: the number of maximum occupants

11-4 Specifications

Charging system specifications

Charging system specifications

N01148501037

Regular charging system	Rated input voltage	AC 240V (single phase)	AC 120V (single phase)
	Rated input frequency	50 Hz/60 Hz	
	Rated current	15 A (max)	8 A/12 A (max)* ¹
	Maximum power consumption	3.3 kVA* ²	1.8 kVA* ²
	Applicable standards	UL2594: Electric Vehicle Supply Equipment SAE J1772: (R) SAE Electric Vehicle and Plug in Hybrid Electric Vehicle Conductive Charge Coupler CSA C22.2 No.107.1-01: General use power supplies	
	Leakage current sensitivity in cable control box	20 mA	
Quick charging system	Applicable standards	CHAdeMO	
	Maximum input current	125 A	
Regular charging/ Quick charging system	Enclosure type	Charge connector: Type 3s Control box (CCID): Type 3	

11

*¹: When using a genuine charging cable with control box

*²: When using a home or public charging device (EVSE: Electric Vehicles Supply Equipment)

Electric motor specifications

Electric motor specifications

N01147301038

Electric motor model	Y51
Maximum output	49 kW
Maximum torque	196 N•m

12V starter battery

N01147801307

34B19L(S)

Battery is a 12 volt type.

Tires and wheels

N01147900734

11

Item		Front	Rear
Tire		145/65R15 72H	175/60R15 81H
Wheel	Size	15x4J	15x5J
	PCD	3.93 in (100 mm)	
	Offset	1.37 in (35 mm)	

PCD: Pitch Circle Diameter (installation holes)

NOTE

- Contact a certified i-MiEV dealer for details on the combination used on your vehicle.
- These tires satisfy vehicle loading conditions described in this owner's manual.

11-6 Specifications

Refill capacities

Refill capacities

N01148002143

No.	Item	Capacity	Lubricants
1	Windshield washer fluid	2.0 qt (1.9 L)	—
2	Brake	As required	Conforming to Brake fluid DOT3 or DOT4
3	Hot water heater fluid [Includes .42 qt (0.4 L) in reservoir]	2.0 qt (1.9 L)	Mitsubishi Motors Genuine Super Long Life Coolant Premium or an equivalent*
4	Coolant [Includes 1.2 qt (1.1 L) in reservoir]	5.4 qt (5.1 L)	
5	Transmission	.79 qt (0.75 L)	Mitsubishi Motors Genuine ATF SPIII
6	Refrigerant (air conditioning)	Refer to the “Air conditioning label” on page 11-2	HFC-134a

*: similar high quality ethylene glycol based non-silicate, non-amine, non-nitrate and non-borate coolant with long life hybrid organic acid technology

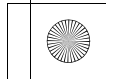
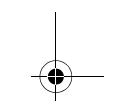
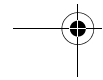
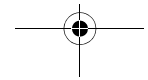
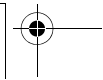
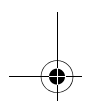
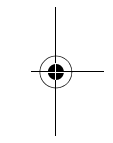
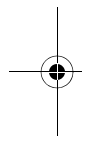
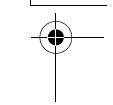
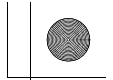
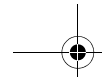
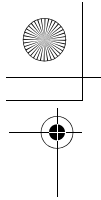

Horizontal dashed lines for writing or printing.

Alphabetical index

Numerics

12V power outlet 5-76
 12V starter battery 9-7
 Specification 11-6
 12V starter battery charging system warning light..... 5-45

A

Accessory (installation) 3-7
 Acoustic vehicle alerting system (AVAS) 5-23
 Active stability control 5-28
 ASC indicator..... 5-30
 ASC OFF indicator 5-30
 ASC OFF switch 5-29
 Skid control function..... 5-29
 Traction control function 5-29
 Air conditioning 7-4
 Important air conditioning operating tips.. 7-10
 Air purifier..... 7-11
 Aluminum wheels..... 9-32
 Antenna 7-27
 Anti-lock braking system..... 5-25
 Warning light 5-26, 5-27
 ASC 5-28
 ASC indicator..... 5-30

ASC OFF indicator..... 5-30
 ASC OFF switch 5-29
 Assist grip 5-81
 Audio
 AM/FM electronically tuned radio with CD player..... 7-11
 Error codes 7-24
 Handling of compact discs 7-25
 Steering wheel audio remote control switch 7-22

B

Back up lights
 Bulb capacity 9-22
 Replacement 9-25
 Ball joint, steering linkage seals and drive shaft boots 9-17
 Battery
 12V starter battery charging system warning light..... 5-45
 Disconnection and connection 9-9
 During cold weather 9-9
 Main drive lithium-ion battery 3-3
 Bluetooth® 2.0 interface 5-53
 Brake
 Anti-lock braking system 5-25
 Braking 6-5
 Fluid 9-7, 11-7
 Hose 9-17
 Parking brake..... 5-16

C

California Perchlorate Materials
 Requirements 3-8
 Capacities 11-7
 Card holder 5-76, 5-80
 Cargo loads 6-10
 Certification label 11-3
 Charging
 Quick charging 3-27
 Regular charging 3-16, 3-26
 Charging indicator 5-44
 Charging Timer 3-41
 Charging troubleshooting guide..... 3-31
 Chassis number..... 11-2
 Child restraint..... 4-13
 Child safety locks for rear door 5-10
 Cleaning

Parking brake lever stroke 9-16
 Pedal 5-24
 Pedal free play..... 9-16
 Power brakes..... 5-24
 Service brake..... 5-24
 Warning light 5-44
 Brake assist system 5-25
 Break-in recommendations 5-2
 Bulb capacity..... 9-22

Alphabetical index

Inside of your vehicle..... 9-28
 Outside of your vehicle 9-30
 Clock..... 7-27
 Cold
 Cautions and actions to deal with intense cold..... 3-10
 Combination headlights and dimmer switch .. 5-46
 Consumer information 10-2
 Coolant..... 9-4, 11-7
 Cruising range..... 3-4
 Cruising range indicator 5-37, 5-40
 Cup holder..... 5-80

D

Dash lights brightness indicator .. 5-37, 5-40
 Daytime running lights
 Bulb capacity 9-22
 Replacement 9-24
 Defogger (rear window) 5-52
 Dimensions 11-4
 Dimmer (high/low beam change) 5-48
 Dinghy towing 6-10
 Disc brake pads 9-17
 Dome light (Front)/Reading lights
 Bulb capacity 9-23
 Switch 5-77

12-2

Dome light (Rear)
 Bulb capacity..... 9-23
 Switch..... 5-78
 Door-ajar warning light and buzzer 5-45
 Doors
 Lock 5-8
 Power door locks 5-9
 Driver's seat belt reminder/warning light..... 4-10
 Driving during cold weather 6-4
 Driving, alcohol and drugs 6-2

E

Economical driving 6-2
 Electric motor
 Number..... 11-3
 Specifications 11-6
 Electric motor switch..... 5-18
 Electric motor unit warning light 5-45
 Electric power steering system (EPS) 5-27
 Electric rear window defogger switch.... 5-52
 Electronic immobilizer (Anti-theft starting system) 5-2
 Energy level gauge..... 5-41
 Energy usage indicator..... 5-37
 EV charging cable 3-23

F

Floor mat 6-2
 Fluid
 Brake fluid..... 9-7, 11-7
 Coolant..... 9-4, 11-7
 Hot water heater fluid 9-4, 11-7
 Washer fluid 9-7, 11-7
 Fluid capacities and lubricants 11-7
 Front fog lights
 Bulb capacity 9-22
 Indicator 5-44
 Replacement 9-24
 Switch 5-50
 Front seats..... 4-3
 Front side-marker lights
 Bulb capacity 9-22
 Replacement 9-23
 Front turn signal lights
 Bulb capacity 9-22
 Replacement 9-24
 Fuses 9-18
 Fusible links..... 9-18

G

Gauges 5-36
 General maintenance..... 9-17
 General vehicle data..... 11-4

Alphabetical index

Genuine parts 3-8
 Glove compartment..... 5-80

H

Hazard warning flasher switch 5-49
 Hazard warning lights 5-44
 Head restraints..... 4-6
 Headlights
 Bulb capacity 9-22
 Dimmer 5-48
 Headlight flasher 5-48
 Reminder buzzer..... 5-48
 Switch 5-46
 Heat
 Cautions and actions to deal with intense heat 3-8
 High beam indicator 5-44
 High-mounted stop light
 Bulb capacity 9-22
 Replacement 9-26
 High-Voltage components 3-34
 Hood 9-3
 Hood lock release mechanism and safety catch..... 9-17
 Horn switch..... 5-53
 Hot water heater fluid..... 9-4, 11-7

I

If the vehicle breaks down..... 8-2
 i-MiEV 3-2
 Cruising range..... 3-4
 Main drive lithium-ion battery 3-3
 Main features 3-2
 Important facts to know in case of an accident 10-3
 Indicator and warning light package 5-43
 Indicators 5-44
 Inside rearview mirror..... 5-16
 Instrument cluster 5-36
 Intense cold
 Cautions and actions 3-10
 Intense heat
 Cautions and actions 3-8
 Interior lights 5-77

J

Jump-starting 8-2

K

Key reminder buzzer..... 5-9, 5-20
 Keyless entry system 5-5
 Keys 5-2

L

Labeling..... 11-2
 License plate lights
 Bulb capacity 9-22
 Replacement..... 9-27
 Liftgate 5-11
 Link System 5-53
 Loading information..... 6-6
 Lubricants 11-7

M

Main drive lithium-ion battery..... 3-3
 Main Drive Lithium-ion Battery Level Indicator 3-50
 MiEV Remote System..... 3-36
 Mirror
 Inside rearview mirror 5-16
 Outside rearview mirrors 5-17
 Modifications to and racing of your vehicle.. 3-6

O

Odometer 5-37, 5-38
 Oil
 Transmission oil 11-7

Alphabetical index

Operation under adverse driving conditions...
8-13
Outside rearview mirrors 5-17
Outside temperature display..... 5-37, 5-41

P

Parking 6-6
Parking brake 5-16
Parking brake lever stroke 9-16
Parking lights
Bulb capacity 9-22
Polishing..... 9-31
Power brakes..... 5-24
Power door locks 5-9
Power down warning light..... 5-46
Power outlet..... 5-76
Power windows 5-14
Precautions during Charging the Main Drive
Lithium-ion Battery 3-15

Q

Quick charging..... 3-27

R

Radio
General information about your radio 7-28
Ready indicator 5-44

12-4

Rear combination lights
Bulb capacity..... 9-22
Replacement..... 9-25
Rear side-marker lights
Bulb capacity..... 9-22
Replacement..... 9-26
Rear turn signal lights
Bulb capacity..... 9-22
Replacement..... 9-25
Rear window defogger switch 5-52
Rear-view camera 5-34
Rearview mirror
Inside..... 5-16
Outside 5-17
Refill capacities 11-7
Regenerative brake system indicator 5-44
Regenerative braking 3-3
Regular charging..... 3-16, 3-26
Remote Climate Control 3-36, 3-47, 7-11
Replacement of light bulbs..... 9-21
Replacing tires and wheels 9-14
Reporting Safety Defects 10-2
Reservoir cap..... 9-6

S

Safe driving techniques..... 6-4
Seat 4-2

Front seats 4-3
Heated seat 4-4
Rear seats 4-5
Seats and restraint systems 4-2
Seat belt..... 4-8
Adjustable seat belt shoulder anchor. 4-11
Child restraint 4-13
Driver's seat belt reminder/warning light ..
4-10
Force limiter 4-13
Front passenger seat belt warning light
4-11
Maintenance and inspection..... 4-20
Pre-tensioner 4-12
Seat belt extender 4-12
Seat belt instructions..... 4-9
Seat belt use during pregnancy 4-12
Selector lever 5-21
Selector lever operation..... 5-21
Selector lever position indicator 5-21
Selector lever positions 5-22
Service brake..... 5-24
Service precautions..... 9-2
Service reminder..... 5-37, 5-38
Skid control function..... 5-29
Snow tires..... 9-15
Speedometer 5-36
Steering
Wheel lock..... 5-20
Stop lights

Alphabetical index

Bulb capacity	9-22
Replacement	9-25
Storage spaces	5-79
Sun visors	5-76
Supplemental Restraint System	4-20
How the Supplement Restraint System works	4-23
Servicing	4-34
Warning light	4-26

T

Tail lights	
Bulb capacity	9-22
Replacement	9-25
Theft-alarm system	5-12
Tire	
Quality grading.....	10-2
Tire pressure monitoring system.....	5-30
Tire repair kit	8-5
Tires	9-10
Inflation pressure	9-13
Maintenance.....	9-15
Replacing tires and wheels.....	9-14
Rotation	9-15
Size (tire and wheel)	11-6
Snow tires	9-15
Tire and loading information placard .	6-7, 11-3
Tire chains	9-16

Tread wear indicators	9-15
Towing.....	8-11
Traction control function.....	5-29
Trailer towing	6-10
Trip odometer	5-37, 5-38
Turn signal lights	
Indicators	5-44
Lever	5-49

U

USB input terminal.....	5-73
How to connect a USB memory device	5-73
How to connect an iPod	5-74

V

Vanity mirror	5-76
Vehicle care precautions	9-28
Vehicle dimensions	11-4
Vehicle labeling	11-2
Vehicle preparation before driving	6-3
Vehicle weights.....	11-4
Vents	7-2

W

Warning lights	5-44
Washer	

Fluid.....	9-7, 11-7
Rear window washer	5-51
Switch	5-51
Windshield washer.....	5-51
Waxing	9-31
Weights	11-4
Wheel	
Specification	11-6
Wiper	
Rear window wiper	5-51
Windshield.....	5-50
Wiper blades	9-16

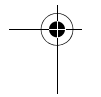
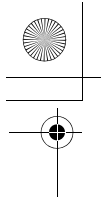

Handwriting practice area consisting of ten horizontal dashed lines.

