

Introduction

N09200102097

Thank you for buying a MITSUBISHI LANCER.

We are confident you will enjoy your vehicle. It has been engineered for optimum performance, durability and comfort. By thoroughly reading this Owner's Manual, you will gain an understanding of the many features that are included in the LANCER. The Owner's Manual contains descriptions and illustrations that will assist in the operation and maintenance of your vehicle.

Your Authorized Mitsubishi Motors Dealer will be happy to assist you with any further questions you may have regarding the operation of your vehicle.

Please note that this manual applies to all LANCER models and explains all features including options. Some features explained in this manual may not be installed on your vehicle.

Please leave this Owner's Manual in the vehicle at the time of resale. The next owner will appreciate having access to the information contained here.

This manual includes instructions for standard and optional equipment available at the time of printing. Mitsubishi Motors Corporation reserves the right to make changes in design and specifications and to make additions or improvements in its product without assuming any obligation to install these on previously manufactured products.



Throughout this manual the words **WARNING** and **CAUTION** appear.

These are reminders to be especially careful. Failure to follow the instructions could result in personal injury or damage to your vehicle.

WARNING

Indicates a strong possibility of severe personal injury or death if instructions are not followed.

CAUTION

Points out hazards or unsafe practices that could cause minor personal injury or damage to your vehicle.

You will see another important symbol:

NOTE Gives helpful information.

WARNING

- **Engine exhaust, some of its constituents, and certain vehicle components contain or emit chemicals known to the State of California to cause cancer and birth defects and reproductive harm. In addition, certain fluids contained in vehicles and certain products of component wear contain or emit chemicals known to the State of California to cause cancer and birth defects or other reproductive harm.**



N09348201032

NOTE

Name of Owner	Date of Purchase
Address of Owner	Model of Vehicle
Name and Address of Dealer	Vehicle Identification Number

Maintenance record

Service Performed	Date	Kilometers Miles	Inspection and Maintenance Item

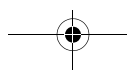

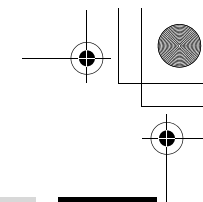
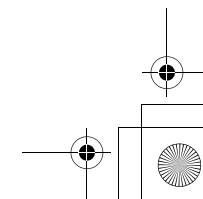
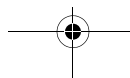
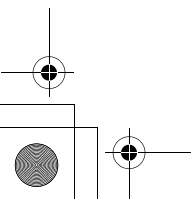
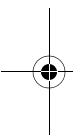

Table of contents

Overview	1
Quick index	2
General information	3
Seat and restraint systems	4
Features and controls	5
Driving safety	6
Comfort controls	7
For emergencies	8
Vehicle care and maintenance	9
Customer assistance/Reporting Safety Defects	10
Specifications	11
Alphabetical index	12



Instruments and controls (Driver's area)

1 Instruments and controls (Driver's area)

N00100202498

Except for RALLIART

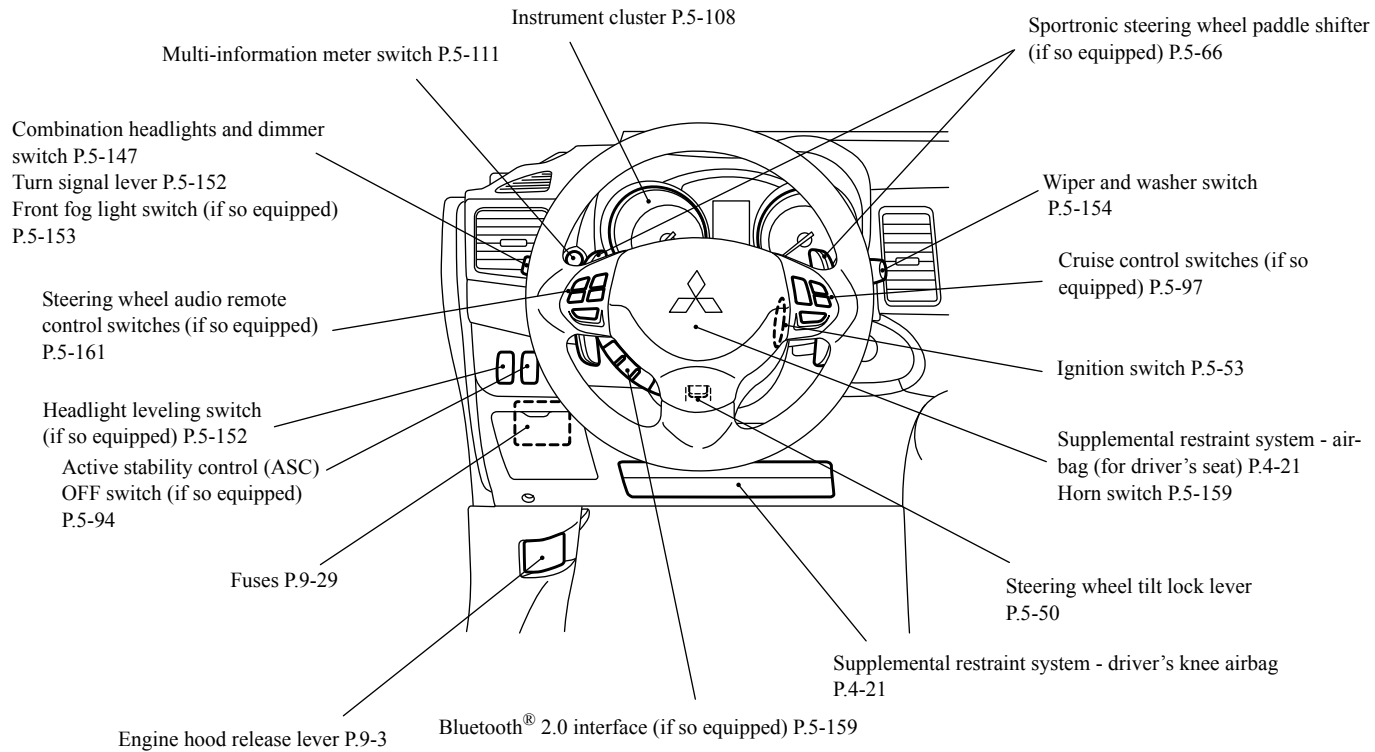

AF5001278

1-1 Overview

Instruments and controls (Driver's area)

1

RALLIART

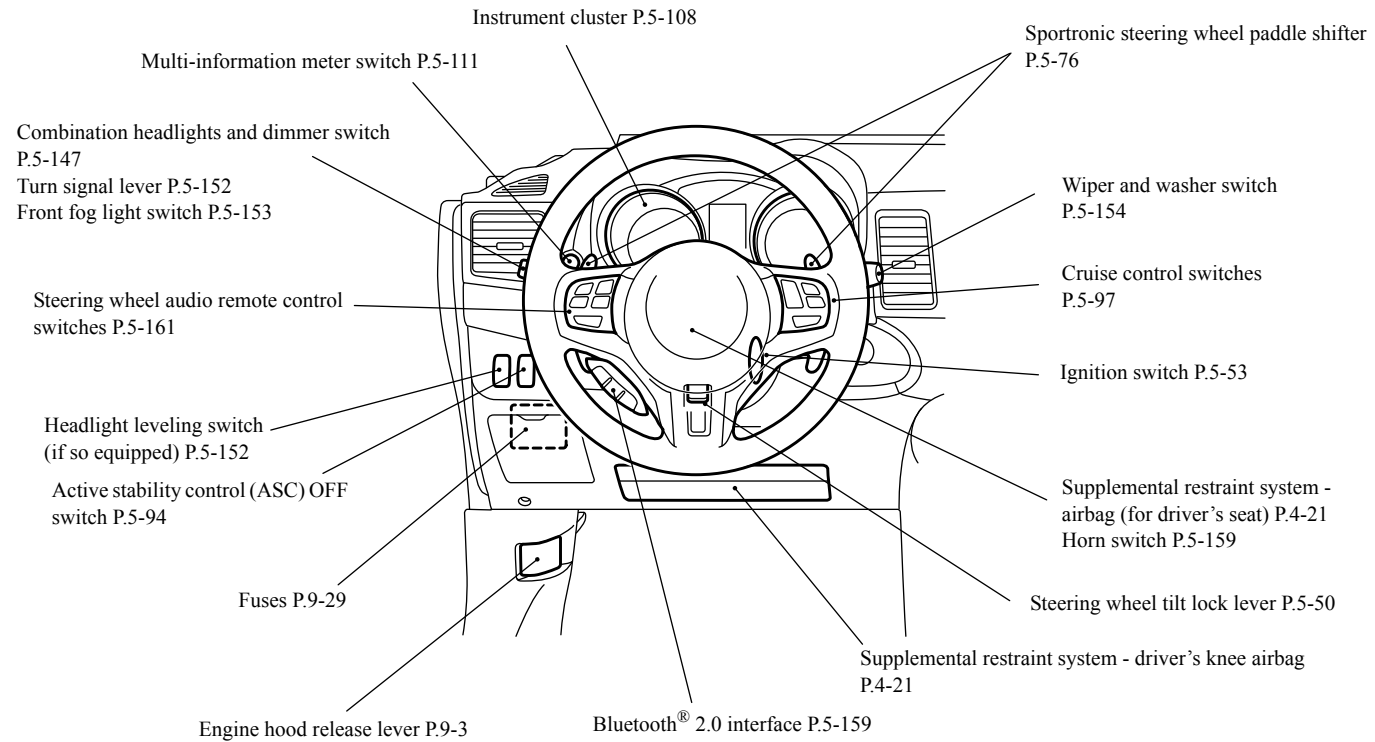

AF5001281

Instruments and controls

1

Instruments and controls

N00100202502

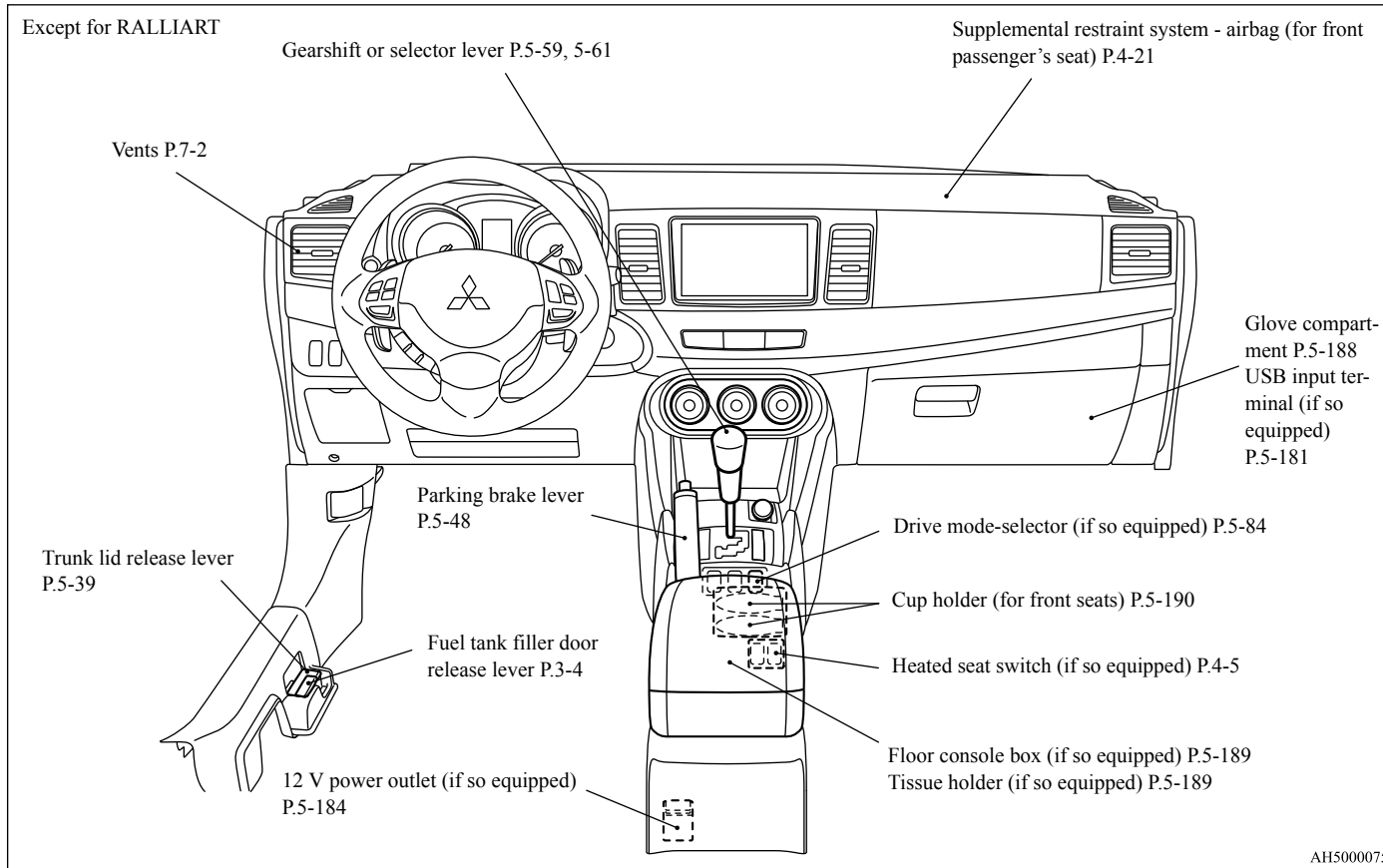

1-3 Overview

Instruments and controls

1

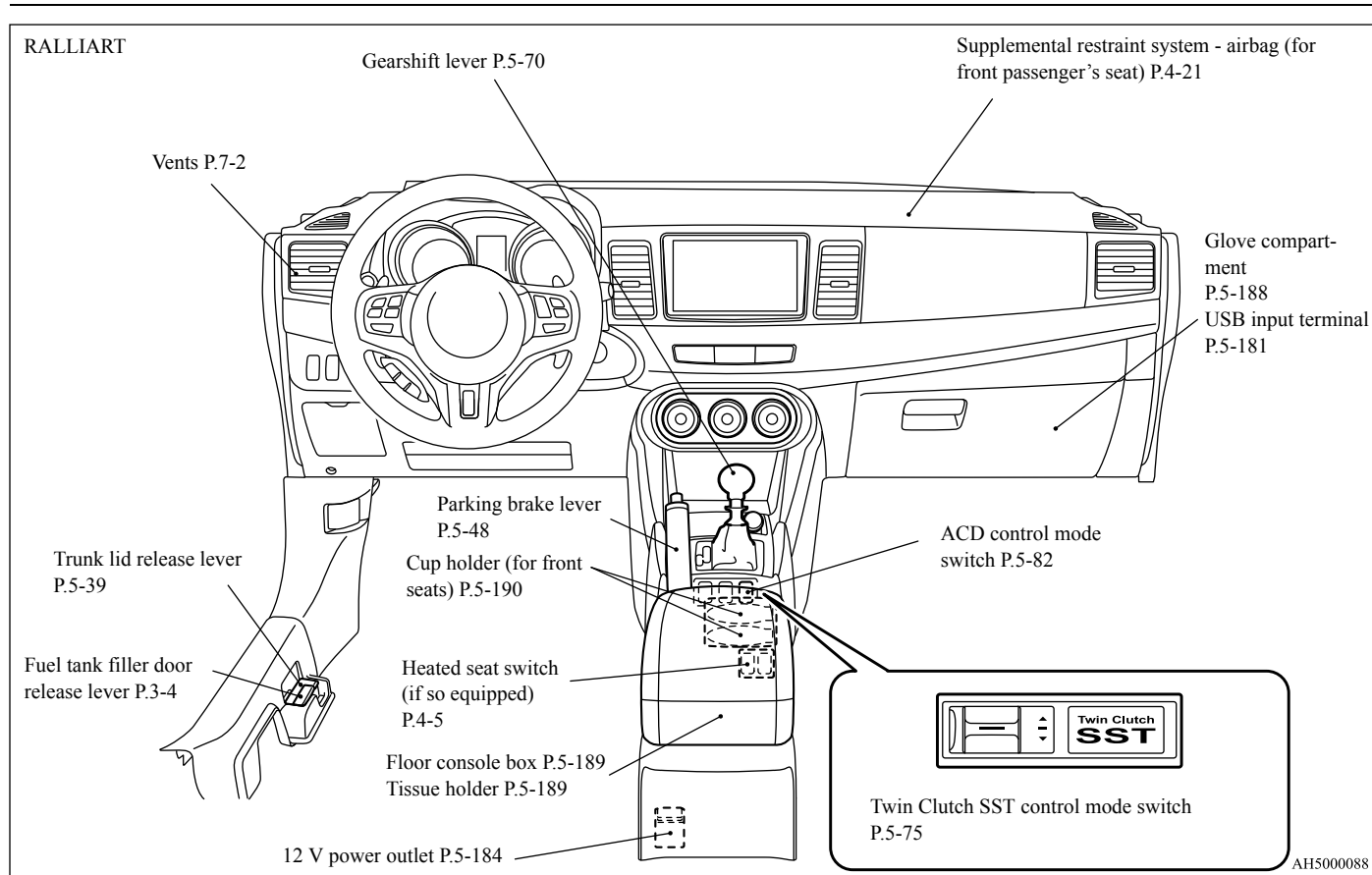

Center panel

1 Center panel

N00100701207

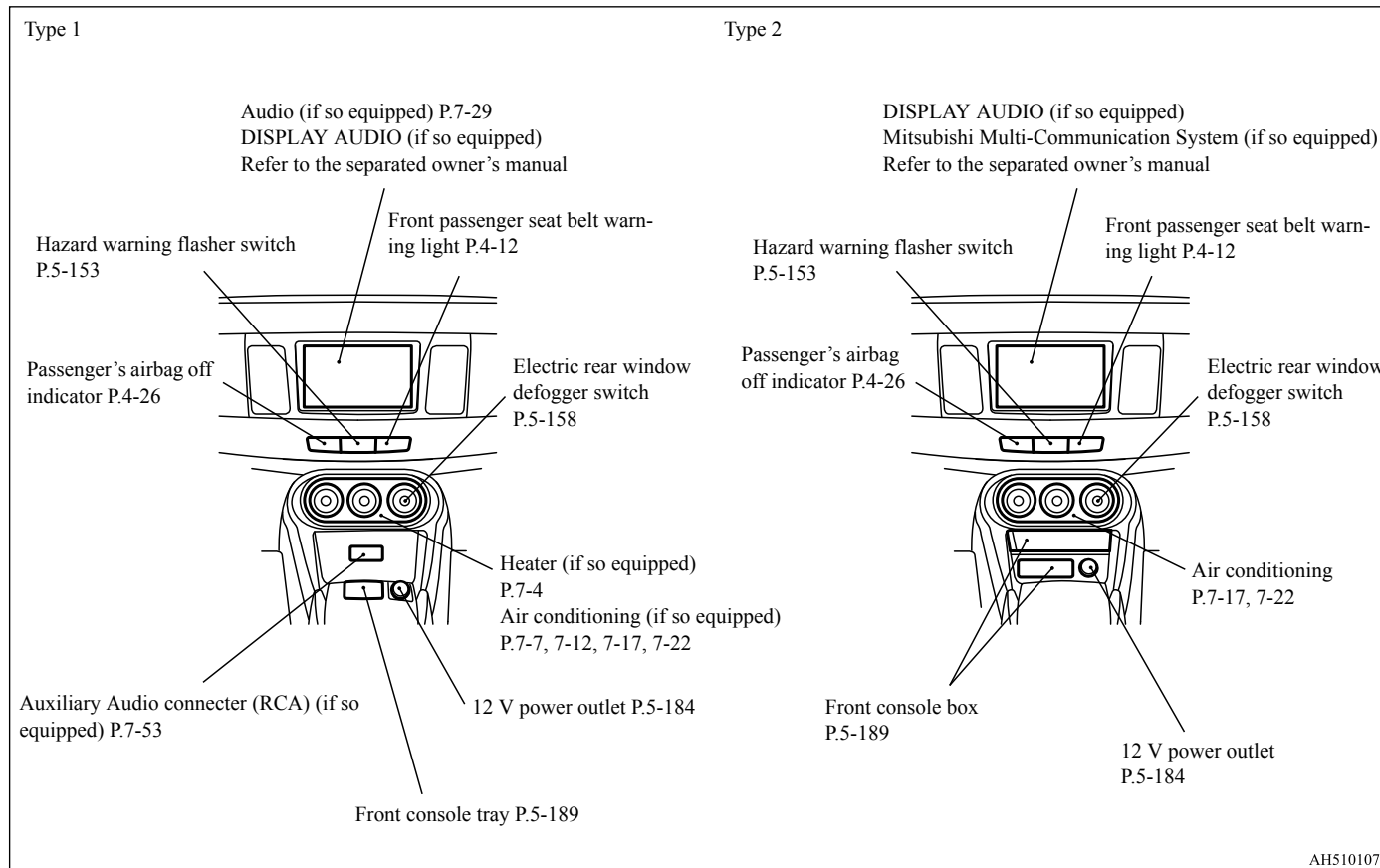

AH5101073

1-5 Overview

Interior

1

N00100302242

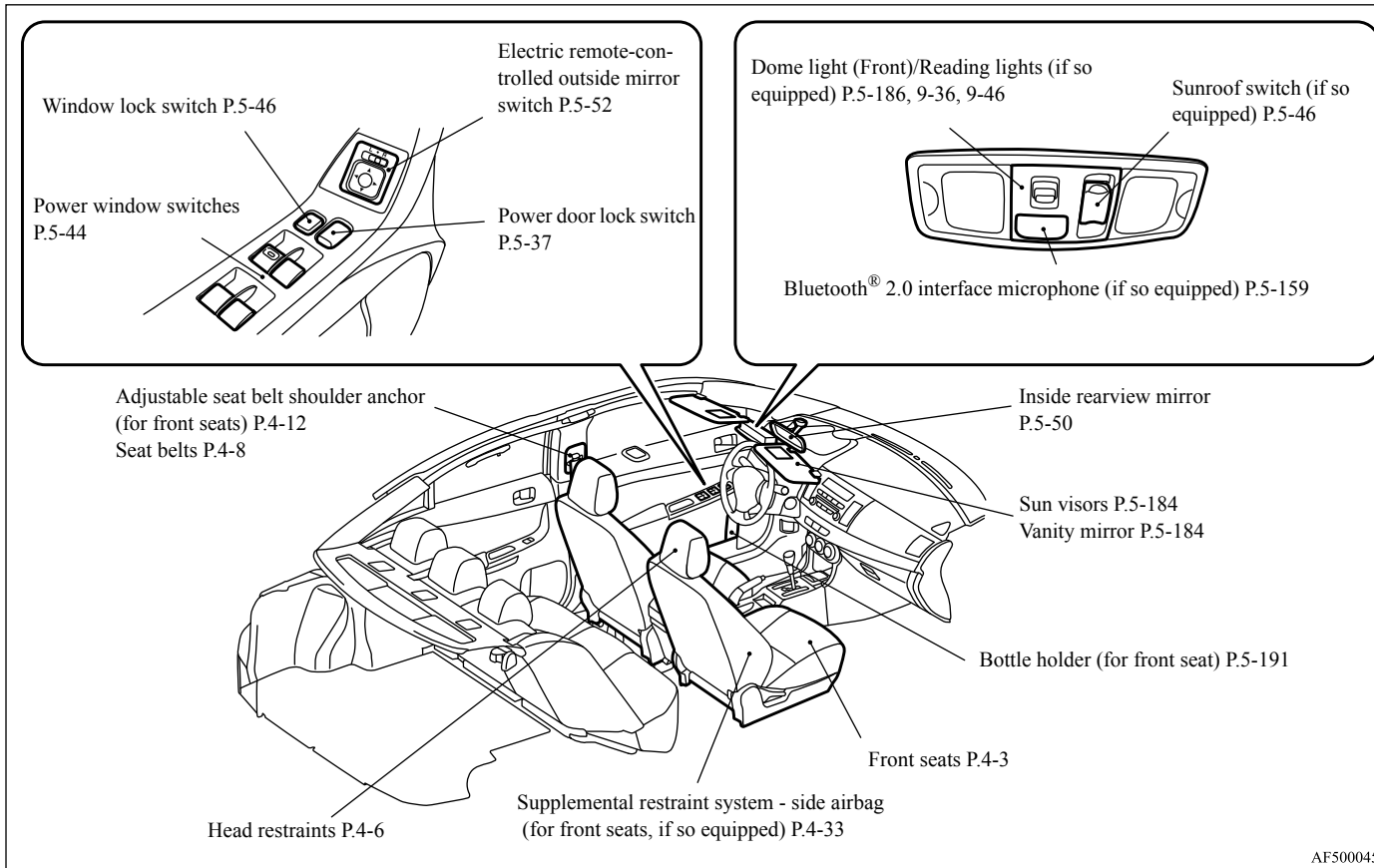

Interior

1

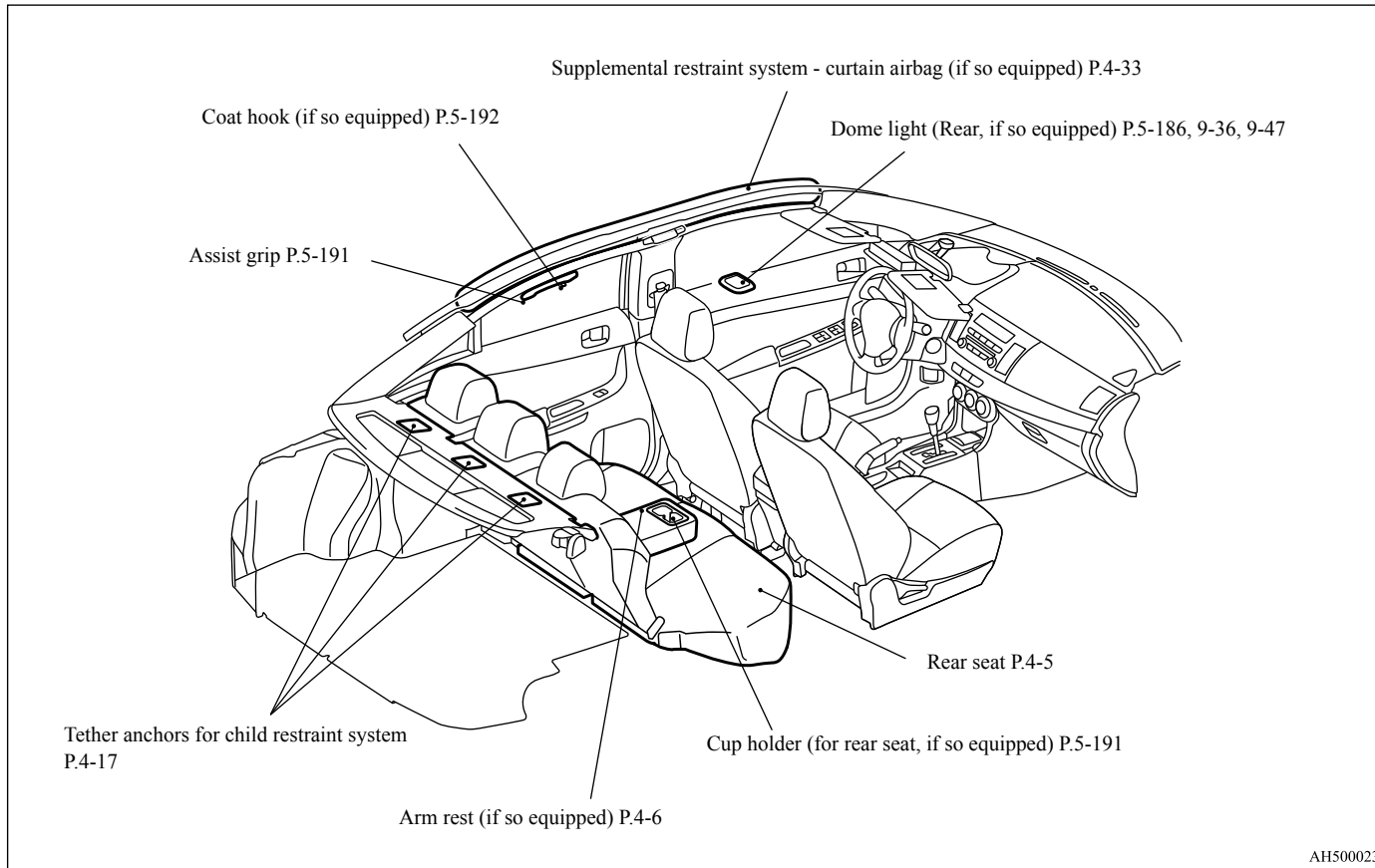

1-7 Overview

Trunk area

Trunk area

1

N00100500413

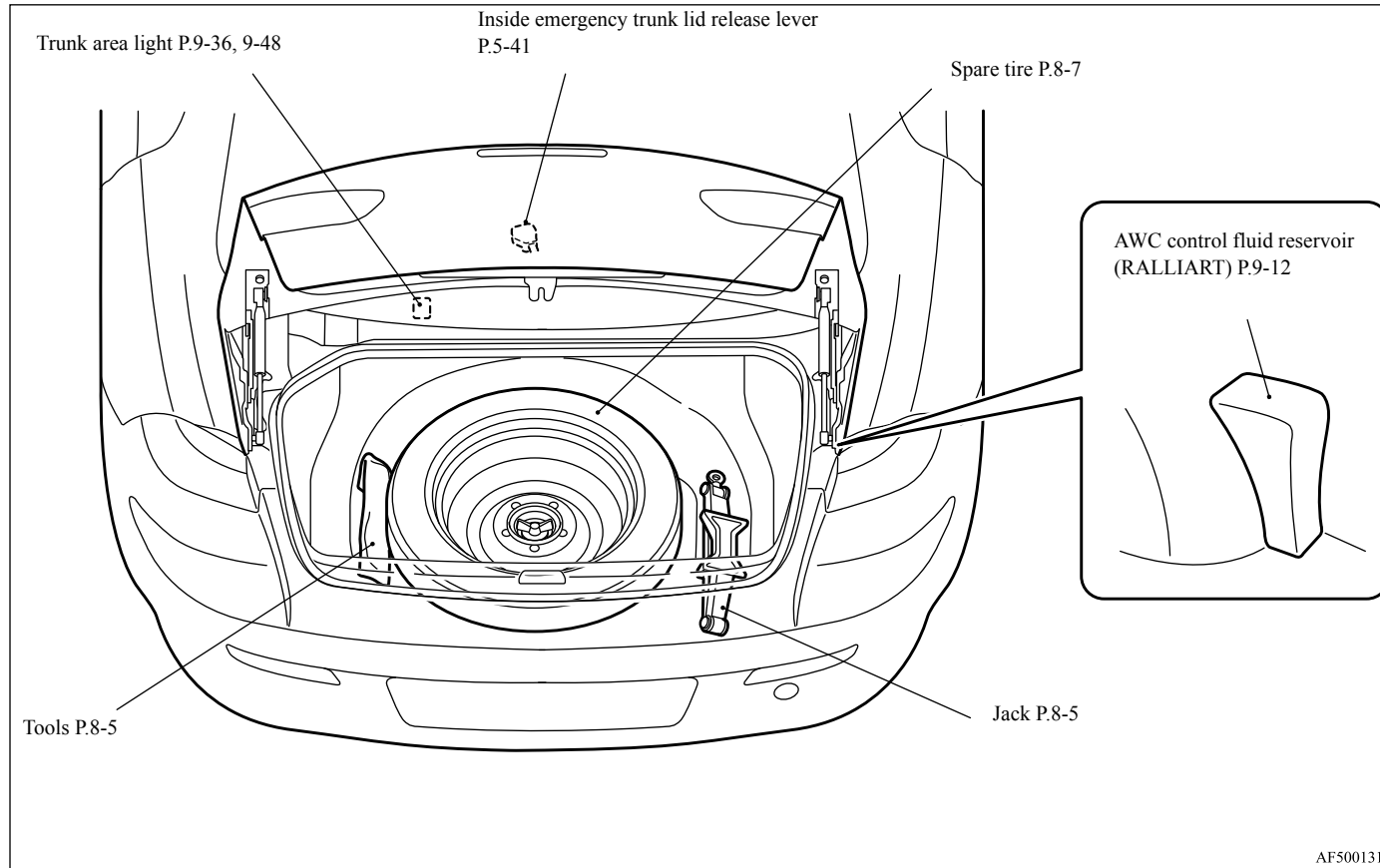

Overview 1-8

Outside (Front)

1 Outside (Front)

N00100602492

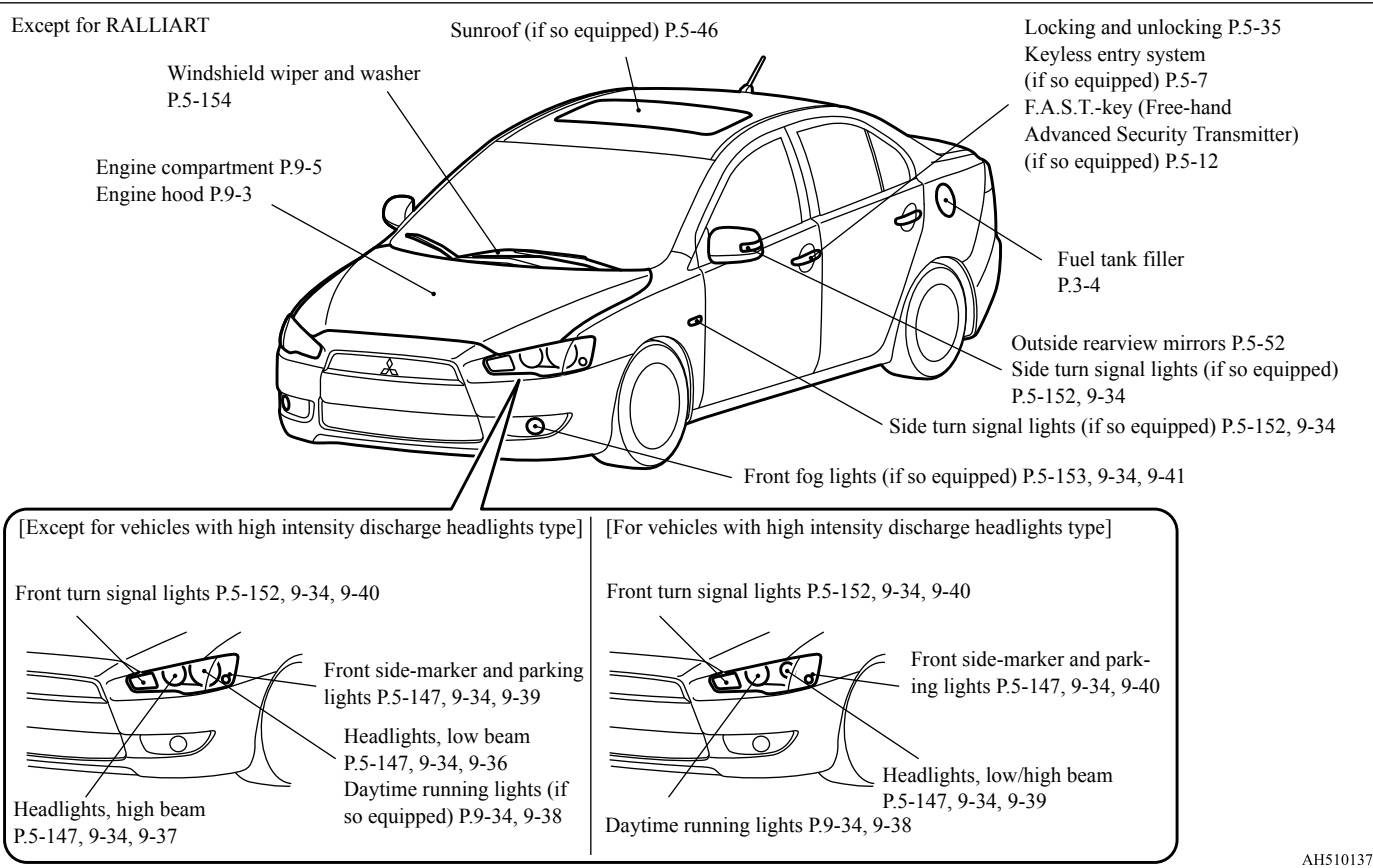

AH5101376

Outside (Front)

1

RALLIART

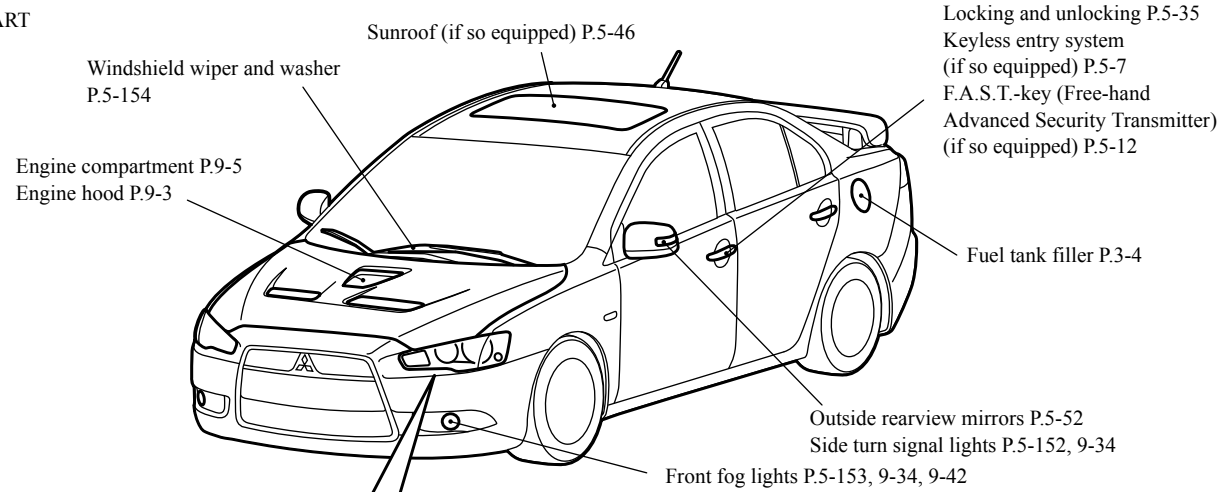

[Except for vehicles with high intensity discharge headlights type]

Front turn signal lights P.5-152, 9-34, 9-40

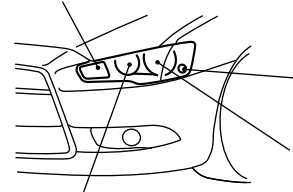

Front side-marker and parking lights P.5-147, 9-34, 9-39

Headlights, low beam P.5-147, 9-34, 9-36
Daytime running lights (if so equipped) P.9-34, 9-38

Headlights, high beam P.5-147, 9-34, 9-37

[For vehicles with high intensity discharge headlights type]

Front turn signal lights P.5-152, 9-34, 9-40

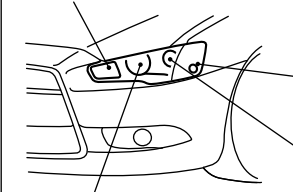

Front side-marker and parking lights P.5-147, 9-34, 9-40

Headlights, low/high beam P.5-147, 9-34, 9-39

Daytime running lights P.9-34, 9-38

AH5101389

Outside (Rear)

1 Outside (Rear)

N00100602362

Except for RALLIART

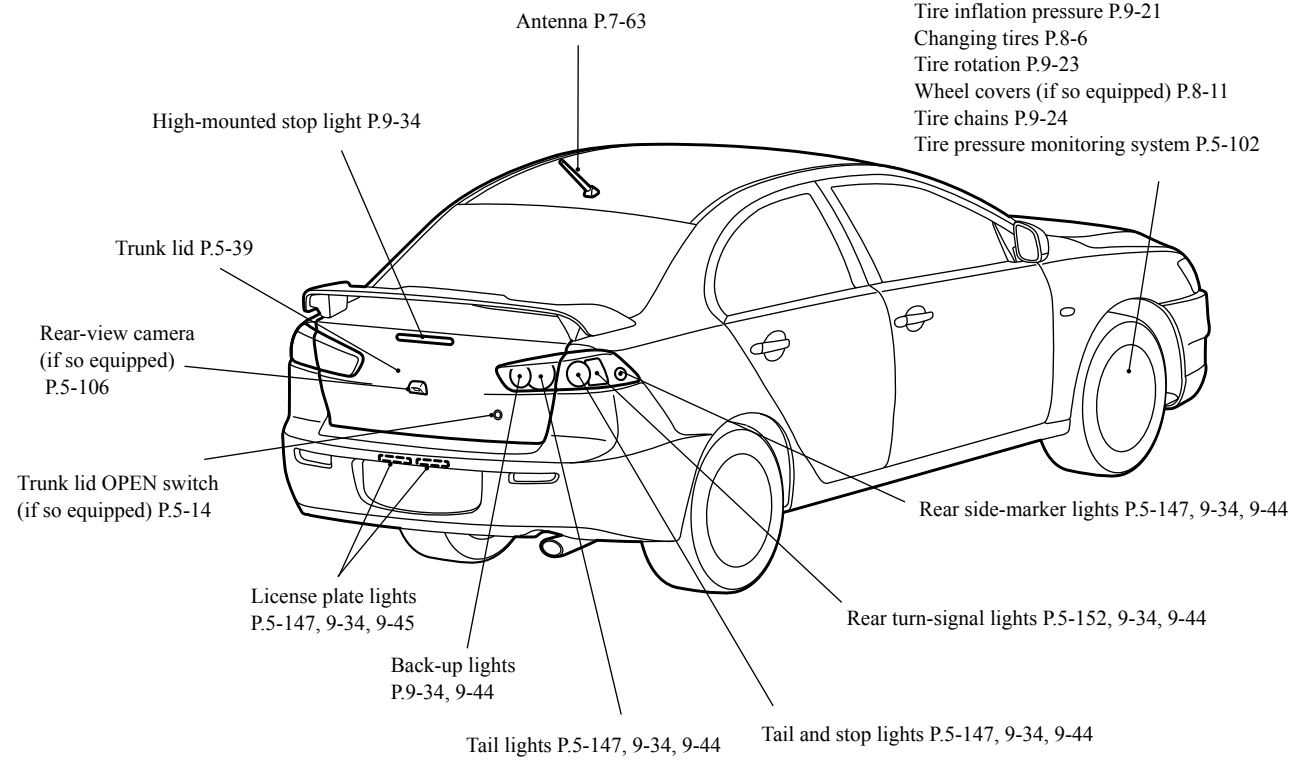

AH5000105

Outside (Rear)

1

RALLIART

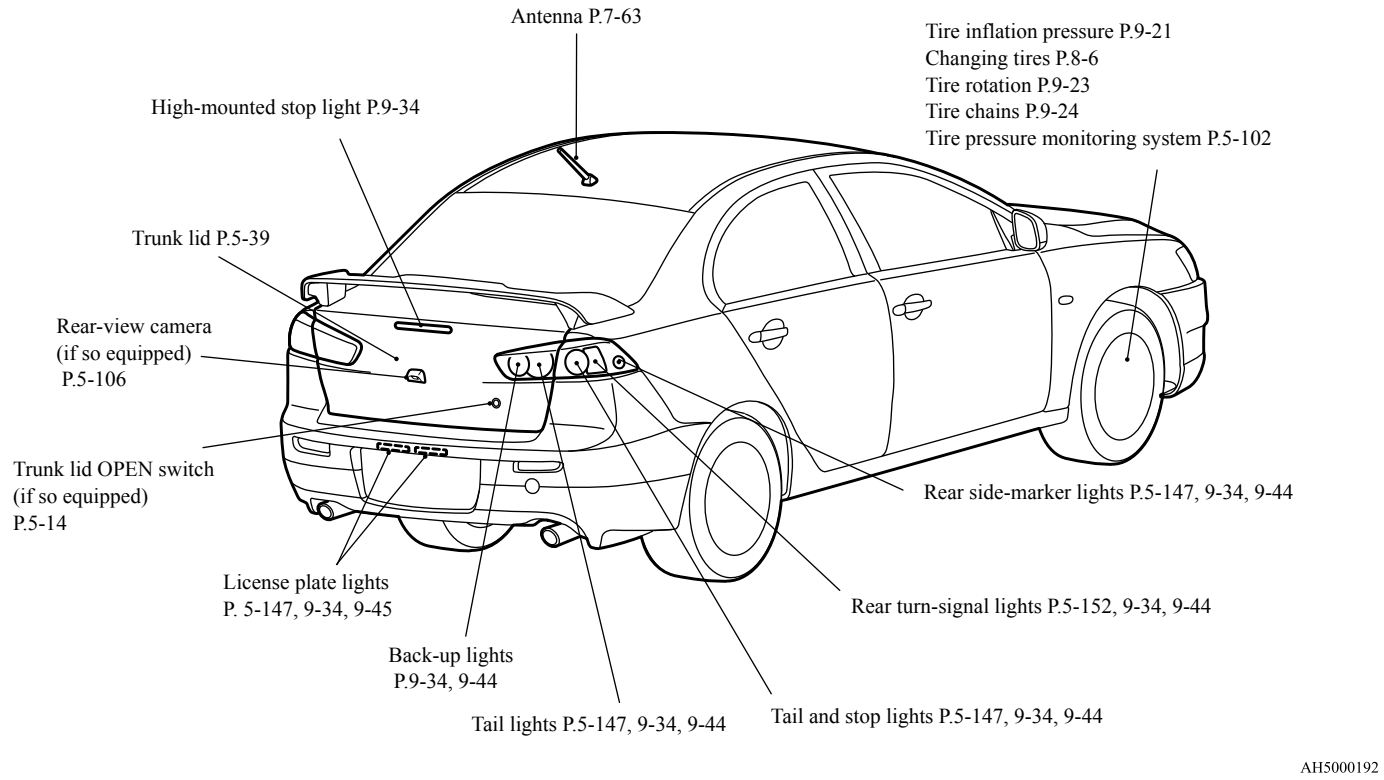

Overview 1-12

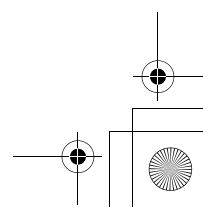
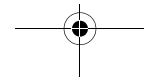
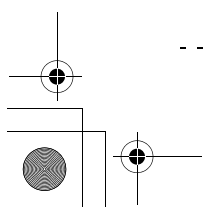
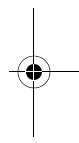
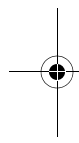
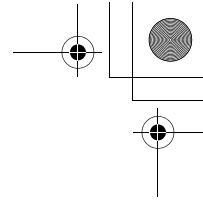
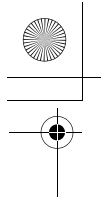

Six sets of horizontal dashed lines for writing, arranged in two groups of three lines each.

If this warning light comes on or flashes while you're driving...



If this warning light comes on or flashes while you're driving...

N00200702191

2



NOTE

- For information regarding warning displays in the multi-information display, refer to “Multi-information display indicators” on page 5-110.
- These warning lights will come on for a few seconds for a bulb check when the ignition switch is first turned to “ON”.

Warning light	Do this	Ref. page
 Charging system warning light	<ul style="list-style-type: none"> ● Park your vehicle in a safe place and stop the engine. Contact an authorized Mitsubishi Motors dealer or a repair facility of your choice for assistance. 	P.5-145
BRAKE or  Brake warning light	<ul style="list-style-type: none"> ● If this light comes on while driving, check to see that the parking brake is fully released. ● If this light stays on after releasing the parking brake, stop and check the brake fluid level. ● If the brake fluid level is correct, there may be a system malfunction. Avoid hard braking and high speeds, and contact an authorized Mitsubishi Motors dealer or a repair facility of your choice for assistance. 	P.5-144
SERVICE ENGINE SOON or  Engine malfunction indicator (“SERVICE ENGINE SOON” or “Check engine light”)	<ul style="list-style-type: none"> ● Although your vehicle will usually be drivable and not need towing, have the engine system checked at an authorized Mitsubishi Motors dealer or a repair facility of your choice as soon as possible. If the vehicle is not drivable, contact emergency roadside assistance at 1-888-648-7820 (for vehicles sold in U.S.A.) or 1-888-576-4878 (for vehicles sold in Canada), an authorized Mitsubishi Motors dealer, or local towing company for assistance. 	P.5-144

If this warning light comes on or flashes while you're driving...

2

Warning light	Do this	Ref. page
 Anti-lock braking system warning light	<ul style="list-style-type: none"> ● When this light comes on, the anti-lock braking system is not functioning and only the ordinary braking system is functioning. ● Park your vehicle in a safe place and stop the engine. Test the system as described on page 5-92. ● If the light does not go out after the test, or if it comes on again, we recommend that you have the system checked at an authorized Mitsubishi Motors dealer or a repair facility of your choice as soon as possible. 	P.5-92, 5-92
 SRS warning light	<ul style="list-style-type: none"> ● Immediately have the airbag and the pre-tensioner seat belt system checked at an authorized Mitsubishi Motors dealer. 	P.4-14, 4-27
 Tire pressure monitoring system warning light	<ul style="list-style-type: none"> ● If the warning light comes on, you should stop and adjust the tires to the proper inflation pressure as soon as possible. (See "Tire inflation pressures" on page 9-21.) Once adjustments have been made, the warning light will go off after a few minutes of driving. ● If the warning light blinks for approximately 1 minute and then remain continuously illuminated, the system is not operating properly. If the system returns to normal, the warning light will go off. If the warning light does not go off, have the vehicle inspected at an authorized Mitsubishi Motors dealer. 	P.5-103

If this problem occurs...

If this problem occurs...

N00200900838

2

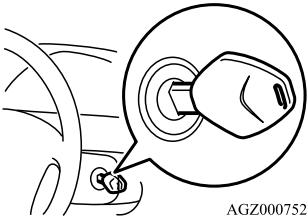
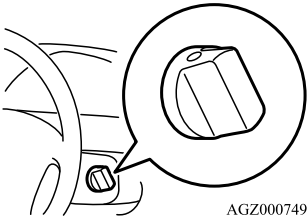

Problem	Do this	Ref. Page
<p>Cannot turn the key. (When using a key to start the engine)</p>  <p style="text-align: right; font-size: small;">AGZ000752</p>	<p>When using a key to start the engine Will not turn from “LOCK” to “ACC”. Turn the key while turning the steering wheel in either direction.</p> <p>Will not turn from “ACC” to “LOCK”. Vehicles with continuously variable transmission (CVT) or Twin Clutch SST: Check the position of the selector lever (CVT) or the gearshift lever (Twin Clutch SST). The key cannot be removed unless the selector lever (CVT) or the gearshift lever (Twin Clutch SST) is set to the “P” (PARK) position. Vehicles with manual transaxle: Place the key at the “ACC” position. Push the key in and turn it.</p>	<p>P.5-54, 5-55</p>
<p>(When using the F.A.S.T.-key to start the engine)</p>  <p style="text-align: right; font-size: small;">AGZ000749</p>	<p>When using the F.A.S.T.-key to start the engine Will not turn from “LOCK (PUSH OFF)” to “ACC”. Push the ignition switch again, turn the steering wheel in both directions and then turn the ignition switch.</p> <p>Will not turn from “ACC” to “LOCK”. Vehicles with CVT or Twin Clutch SST: Check whether the selector lever (CVT) or the gearshift lever (Twin Clutch SST) is set to the “P” (PARK) position. Vehicles with manual transaxle: Place the ignition switch at the “ACC” position. Push the ignition switch in and turn it.</p>	<p>P.5-12</p>
<p>The F.A.S.T.-key does not operate. (for vehicles equipped with the F.A.S.T.-key)</p>	<p>Use the emergency key to lock and unlock the doors and start the engine.</p>	<p>P.5-23</p>

If this problem occurs...

2

Problem	Do this	Ref. Page
Cannot shift the selector lever (CVT) or the gearshift lever (Twin Clutch SST) from the "P" (PARK) position. (for vehicles with CVT or Twin Clutch SST)	Shift the selector lever (CVT) or the gearshift lever (Twin Clutch SST) while pressing the brake pedal. Check that the ignition key or ignition switch is in the "ON" position.	P.5-61, 5-70
The windows are fogged up. 	1. Set the mode selection dial to the "☀" or "☂" position. 2. Turn on the blower.	P.7-6, 7-12, 7-17, 7-22, 7-27
The engine does not start. The lights do not come on. The lights are dim. The horn does not honk. The horn sound is weak.	Have the battery checked. Recharge or replace as needed.	P.8-2, 9-14

If this problem occurs...

Problem	Do this	Ref. page
<p>The engine coolant temperature display “” in the multi-information display is flashing. Steam comes out of the engine compartment. Type 1</p>  <p>Type 2</p> 	<p>The engine is overheated. Carefully stop the vehicle in a safe place.</p>	<p>P.8-4</p>
<p>If your vehicle becomes stuck in sand, mud or snow</p>	<ol style="list-style-type: none"> 1. Slowly press down on the accelerator pedal to get your vehicle moving again. For vehicle equipped with the Electronically controlled 4WD system, set the drive mode-selector to the “4WD AUTO” or “4WD LOCK” position and then slowly press down on the accelerator pedal to get your vehicle moving. 2. If there is nothing to stop your tires from slipping, rock your vehicle back and forth to free it. 	<p>P.8-14</p>

2



⚠ WARNING

- When attempting to rock your vehicle out of a stuck position, be sure that no one is near the vehicle. The rocking motion may cause the vehicle to suddenly lurch forward or backward, possibly injuring bystanders.
- Avoid revving the engine or spinning the wheels. Prolonged efforts to free a stuck vehicle may result in overheating and transaxle failure.
If the vehicle remains stuck after several rocking attempts, have a towing service pull the vehicle out.

Quick index 2-5

If this problem occurs...

2

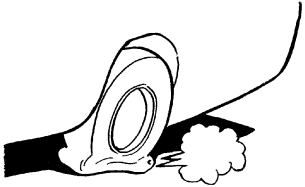
Problem	Do this	Ref. page
The brakes are not functioning properly after driving through water.	Dry out the brakes by driving slowly while lightly pressing the brake pedal.	P.6-5
The CVT makes no engine speed to vehicle speed ratio change when accelerating. The initial movement of the vehicle is slow when the vehicle starts moving. (for vehicles with CVT)	There may be a problem in the CVT. If the  or  warning lights on the multi-information display will not turn off, or if they are coming on frequently, please have the vehicle checked at your nearest Mitsubishi Motors dealer.	P.5-69
Twin Clutch SST does not shift. Vehicle cannot move. Acceleration is slow. The vehicle does not creep. A large shock is felt when shifting. Shifting occurs at higher engine speed. Response is slow. (for vehicles with Twin Clutch SST)	The temperature of the Twin Clutch SST fluid is high, a safety device in the Twin Clutch SST has been activated due to a possible malfunction in the Twin Clutch SST, or there is a possible malfunction in the engine electronic control module.	P.5-72, 5-81, 5-144
A tire is punctured. 	1. Park the vehicle in a safe place where the surface is flat and level. 2. Replace the flat tire with the spare tire.	P.8-6

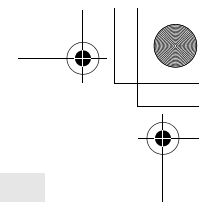

General information

Fuel selection	3-2
Filling the fuel tank	3-4
Modifications to and racing of your vehicle	3-5
Mitsubishi Motors genuine parts	3-6
California Perchlorate Materials Requirements	3-7

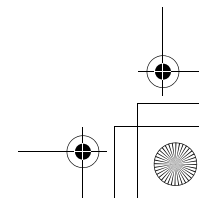
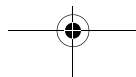
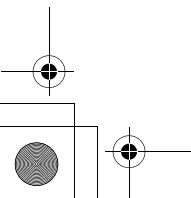
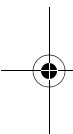

Fuel selection

Fuel selection

N00301000866

3

Your vehicle is designed to use unleaded gasoline only. It is equipped with a fuel filler tube especially designed to accept only a small diameter unleaded gasoline dispensing nozzle.

! WARNING

- Gasoline is highly flammable and explosive. You could be burned, seriously injured or killed when handling it. Whenever you refuel your vehicle, stop the engine and keep flames, sparks, and smoking materials away from the vehicle. Always handle fuel in well-ventilated outdoor areas.

! CAUTION

- Using leaded gasoline in your vehicle will damage the engine, catalytic converter, and the oxygen sensors. Also, using leaded gasoline is illegal, and will void your warranty coverage of the engine, catalytic converter, and oxygen sensors.

Gasoline detergent additives

In the United States, fuel suppliers are required by law to add detergents to their gas-

3-2 General information

oline to minimize fuel-injector fouling and minimize intake-valve deposits. Detergent gasoline helps keep your engine in tune and your emission-control system working properly.

Octane requirement

Except for RALLIART

Your vehicle is designed to operate on unleaded gasoline having a minimum octane number of 87 [(MON+RON)/2], or 91 RON.

RALLIART

Your vehicle is designed to operate on premium grade unleaded gasoline having a minimum octane number of 93 [(MON+RON)/2] or higher for optimum performance. In case premium grade unleaded gasoline 93 [(MON+RON)/2] is not available, unleaded gasoline number of 91 [(MON+RON)/2] can be used. However, the performance level is reduced.

In order to maintain exhaust system durability, premium unleaded gasoline having an octane number of at least 91 [(MON+RON)/2] must be used.

If the premium grade unleaded gasoline number of 91 [(MON+RON)/2] or higher is not available on journey, etc., regular unleaded gasoline having an octane number of 87 [(MON+RON)/2] can be used temporarily as an emergency measure.

MON: Motor Octane Number
RON: Research Octane Number

Oxygenated gasoline

Gasoline sold at some service stations contains oxygenates such as ethanol, although the oxygenates may not be identified by those names. Oxygenates are required in some areas of the country. Such fuel can be used in your vehicle.

Ethanol (Gasohol)

A mixture of up to 10 % ethanol (grain alcohol) and 90 % unleaded gasoline may be used in your vehicle, provided the octane number is at least as high as that recommended for unleaded gasoline.

Methanol

Do not operate your vehicle on gasoline containing methanol (wood alcohol). Using this type of alcohol could adversely affect the vehicle's performance and damage critical parts of the vehicle's fuel system.

Reformulated gasoline

Many areas of the country require the use of cleaner burning fuel referred to as "Reformulated Gasoline".

Reformulated gasoline contains oxygenates and is specially blended to reduce vehicle emissions and improve air quality.

Mitsubishi Motors Corporation strongly supports the use of reformulated gasoline. Properly blended reformulated gasoline has no adverse effect on vehicle performance or the durability of the engine and fuel system.

MMT (methylcyclopentadienyl manganese tricarbonyl)

MMT is a manganese-containing metallic additive that is blended into some gasolines to increase the octane number.

Mitsubishi Motors Corporation recommends using gasolines without MMT.

Use of gasolines blended with MMT may adversely affect performance, and cause the malfunction indicator on your instrument panel to come on. If this happens, contact an authorized Mitsubishi Motors dealer or a repair facility of your choice for assistance.

Sulfur in gasoline

Your vehicle may have been designed to satisfy California's low-emission regulations based on clean-burning low-sulfur gasoline. Gasoline sold in parts of the country other than California is allowed to have a higher sulfur content. Using such gasoline could adversely affect the vehicle's catalytic converter and cause the engine malfunction indicator ("SERVICE ENGINE SOON" or "CHECK ENGINE") to come on. Illumination of this indicator while you are using high-sulfur gasoline does not necessarily mean the vehicle's emission-control system is malfunctioning. Your authorized Mitsubishi Motors dealer may suggest you try using a different, lower-sulfur brand of unleaded gasoline to determine whether the problem is fuel-related.

NOTE

- Poor-quality gasoline can cause problems such as poor starting, stalling during idling, abnormal engine noise, and poor acceleration. If you experience any of these problems, try using a different brand of gasoline. If the engine malfunction indicator ("SERVICE ENGINE SOON" or "CHECK ENGINE") flashes, have the vehicle inspected as soon as possible by the nearest authorized Mitsubishi Motors dealer or a repair facility of your choice.
- Repeatedly driving short distances at low speeds can cause deposits to form in the fuel system and engine, resulting in poor starting and poor acceleration. If these problems occur, you are advised to add a detergent additive to the gasoline when you refuel the vehicle. The additive will remove the deposits, thereby returning the engine to a normal condition. Be sure to use a Mitsubishi Motors Genuine cleaning additive. Using an unsuitable additive could make the engine malfunction. For details, please contact the nearest authorized Mitsubishi Motors dealer.

Filling the fuel tank

Filling the fuel tank

N00301100900

3

⚠ WARNING

- Gasoline is highly flammable and explosive. You could be burned, seriously injured or killed when handling it. When refueling your vehicle, always turn the engine off and keep away from flames, sparks, and smoking materials. Always handle fuel in well-ventilated outdoor areas.
- Before removing the fuel cap, be sure to get rid of your body's static electricity by touching a metal part of the car or fuel pump. Any static electricity on your body could create a spark that ignites fuel vapor.
- Perform the whole refueling process (opening the fuel tank filler door, removing the fuel cap, etc.) by yourself. Do not let any other person come near the fuel tank filler. If you allowed a person to help you and that person was carrying static electricity, fuel vapor could be ignited.
- Do not move away from the fuel tank filler until refueling is finished. If you moved away and did something else (for example, sitting on a seat) part-way through the refueling process, you could pick up a fresh charge of static electricity.
- Be careful not to inhale fuel vapor. Fuel contains toxic substances.

⚠ WARNING

- Keep the doors and windows closed while refueling the vehicle. If they were open, fuel vapor could get into the cabin.

Fuel tank capacity

Front-wheel drive vehicles: 15.5 gal (59.0 L)
All-wheel drive vehicles: 14.5 gal (55.0 L)

Refueling

1. Before filling with fuel, stop the engine.
2. The fuel tank filler is located on the rear driver side of your vehicle.

The fuel tank filler door can be opened from inside the vehicle with the fuel tank filler door release lever located at the left side of the driver's seat.

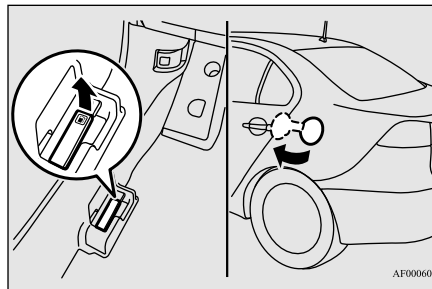

AF0006063

3. Open the fuel tank filler pipe by slowly turning the cap counterclockwise.

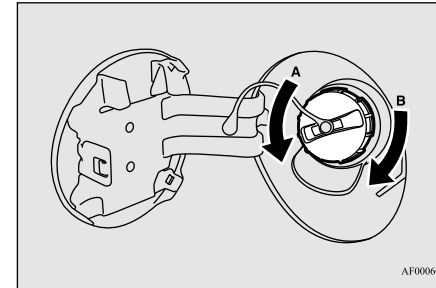

AF0006076

- A- Remove
B- Close

⚠ WARNING

- Since the fuel system may be under pressure, remove the fuel tank filler cap slowly. This relieves any pressure or vacuum that might have built up in the fuel tank. If the cap is venting vapor or if you hear a hissing sound, wait until it stops before removing the cap. Otherwise, fuel may spray out, injuring you or others.

4. While filling with fuel, store the cap in the cap holder located on the inside of the fuel tank filler door.

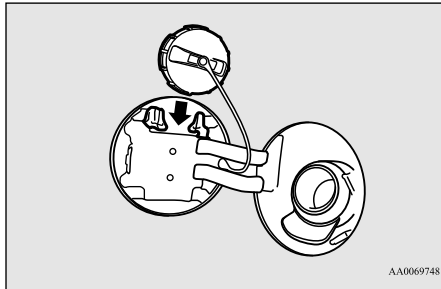

5. To fill with fuel correctly depends mainly on correct handling of the fuel filler nozzle. Do not tilt the nozzle. Insert the nozzle in the tank port as far as it will go.

CAUTION

- Your vehicle can only be operated using unleaded gasoline. Serious engine and catalytic converter damage will result if leaded gasoline is used.

6. When the nozzle stops automatically, do not attempt to add more fuel.

CAUTION

- To avoid fuel spillage and overfilling, do not “top-off” the fuel tank. Spilled fuel could discolor, stain, or crack the vehicle’s paintwork. If fuel spills on the paintwork, wipe it off with a soft cloth.

7. To close, turn the fuel tank filler cap slowly clockwise until you hear clicking sounds, then gently push the fuel tank filler door closed.

WARNING

- **Make sure the fuel cap is securely closed. If the fuel cap is loose, fuel could leak, resulting in a fire.**

CAUTION

- If you need to replace the fuel tank filler cap, use only the cap specified for your model vehicle.

NOTE

- If the fuel tank filler cap is not tight while driving, the engine malfunction indicator (“SERVICE ENGINE SOON” or “Check engine light”) may come on when the onboard diagnostic (OBD) system performs a self check. Always tighten the fuel tank filler cap until you hear clicking sounds. The indicator will go off after driving several times. If the indicator does not go off, contact your authorized Mitsubishi Motors dealer or a repair facility of your choice as soon as possible.

Modifications to and racing of your vehicle

Modifications to and racing of your vehicle

N00301600048

3

This vehicle should not be modified with non-Mitsubishi Motors genuine parts. Mitsubishi Motors designs and manufactures high quality vehicles with an emphasis on safety and durability. Modifications using non-Mitsubishi Motors genuine parts may affect the performance, safety and/or durability of your vehicle, and may violate applicable state and/or federal regulations.

DAMAGE OR PERFORMANCE PROBLEMS RESULTING FROM MODIFICATIONS TO OR RACING OF YOUR VEHICLE ARE NOT COVERED UNDER WARRANTY.

Examples of modifications to your vehicle that can cause damage or performance problems include the following:

- Failure to use Mitsubishi Motors genuine parts
- Failure to use required fuel and fluids
- Failure to use proper size tires and wheels
- Modification of the fuel, intake, exhaust, emission, suspension, engine, drive train or electrical wiring systems

Mitsubishi Motors genuine parts

3

Review the Warranty and Maintenance Manual for further details regarding warranty coverage.

Installation of accessories

N00301700182

CAUTION

- Before any electrical or electronic accessories are installed, consult an authorized Mitsubishi Motors dealer.

- The installation of accessories, optional parts, etc., should only be carried out within the limits prescribed by law in the driving area and in accordance with the guidelines and warnings contained within the documents accompanying this vehicle. Only Mitsubishi Motors approved accessories should be fitted to your vehicle.
- Improper installation of electrical parts could cause fire. Refer to the “Modification/alterations to the electrical or fuel systems” section within this owner’s manual.

3-6 General information

- Using a cellular phone or radio set inside the vehicle without an external antenna may cause electrical system interference, which could lead to unsafe vehicle operation.
- Tires and wheels which do not meet specifications must not be used. Refer to the “Specifications” section for information regarding wheel and tire sizes.

WARNING

- **If you choose to use a cellular phone while driving, you must not allow that usage to distract you in the safe operation of your vehicle. Anything, including cellular phone usage, that distracts you from the safe operation of your vehicle increases your risk of an accident. Refer to and follow all state and local laws in your area regarding cellular phone usage while driving.**

Important point!

Due to the large number of accessory and replacement parts provided by different manufacturers in the market, it is not always possible for an authorized Mitsubishi Motors dealer to check whether the attachment or installation of non-Mitsubishi Motors genu-

ine parts will affect the driving safety of your Mitsubishi-vehicle.

Modification/alterations to the electrical or fuel systems

N00301800040

Mitsubishi Motors manufactures high quality vehicles with an emphasis on safety. It is important to consult an authorized Mitsubishi Motors dealer before installation of any accessory which may involve modification of the electrical or fuel systems.

CAUTION

- Please consult an authorized Mitsubishi Motors dealer concerning any such accessory fitment or modification. If the wires interfere with the vehicle body or improper installation methods are used (protective fuses not included, etc.), electronic devices may be adversely affected, resulting in a fire, vehicle damage, or other accident.

Mitsubishi Motors genuine parts

N00301400105

Mitsubishi Motors Genuine Parts are designed and manufactured to meet high standards of performance, and are recommended for all of your maintenance needs. Also avail-

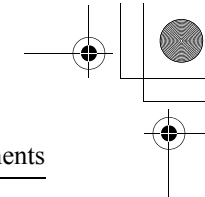

California Perchlorate Materials Requirements

able from your Mitsubishi Motors dealer are a wide variety of accessories to personalize your new vehicle. Each Mitsubishi vehicle has a selection of Mitsubishi Motors authorized accessories to choose from to tailor your new vehicle to your own personal preference. Your Mitsubishi Motors dealer's Parts Manager has information on various audio systems, protection items, as well as interior and exterior accessories available for your specific model.

3

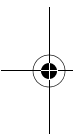

California Perchlorate Materials Requirements

N00300100017

Certain components of this vehicle, such as airbag modules, seat belt pretensioners, and button cell batteries, may contain perchlorate materials.

Special handling may apply. For additional information, see www.dtsc.ca.gov/hazardous-waste/perchlorate.

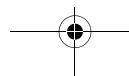
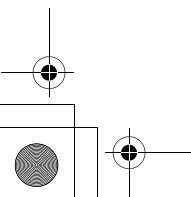
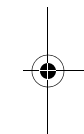

General information 3-7

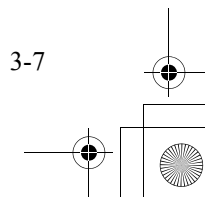

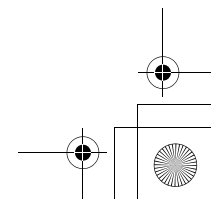
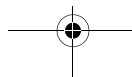
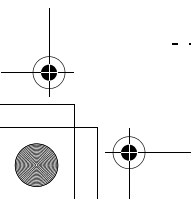
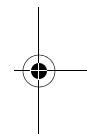
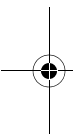
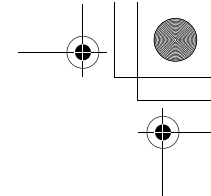
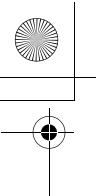

Horizontal dashed lines for writing

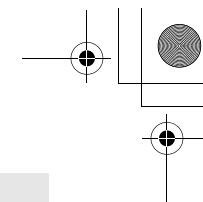

Seat and restraint systems

Seats	4-2
Seats and restraint systems	4-2
Front seats	4-3
Rear seats	4-5
Head restraints	4-6
Seat belts	4-8
Seat belt use during pregnancy	4-13
Seat belt pre-tensioner and force limiter systems	4-13
Child restraint systems	4-14
Maintenance and inspection of seat belts	4-21
Supplemental Restraint System (SRS) - airbag	4-21

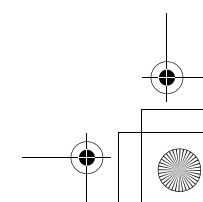
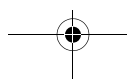
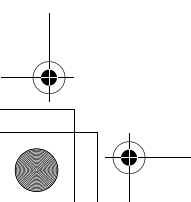
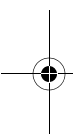

Seats

Seats

N00408400479

4

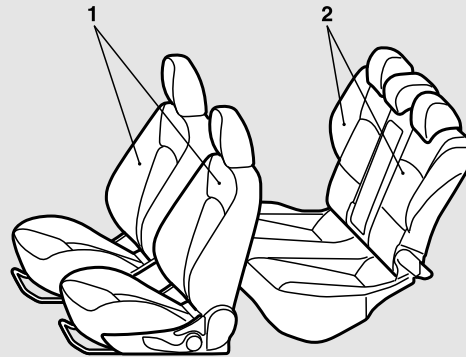

AG1000957

1 - Front seats

- To adjust the seat forward or backward → P.4-3
- To adjust the seatback → P.4-4
- To adjust the seat height (Driver's side only, if so equipped) → P.4-4
- Heated seats (if so equipped) → P.4-5

2 - Rear seats

- Folding the seatbacks forward (if so equipped) → P.4-5

- Arm rest (if so equipped) → P.4-6

Seats and restraint systems

N00401600182

Your vehicle has seat belts and other features that help protect you and your passengers in an accident.

Seat belts are the most important safety device. When worn properly, seat belts can reduce the chance of serious injury or death in various types of crashes. For added protection during a severe frontal collision, your vehicle has a Supplemental Restraint System (SRS) with airbags for the driver and passen-

gers. The seats, head restraints, and door locks also are safety equipment, which must be used correctly.

Always check the following before you drive:

- That everyone in your vehicle is properly wearing their seat belt.
- That infants and small children are properly secured in appropriate child restraint systems in the rear seat.
- That all doors are fully closed and locked.
- That seatbacks are upright, with head restraints properly adjusted.

Safety equipment cannot prevent injury or death in all motor vehicle accidents. You can help reduce the risk of injury or death, however, by following the instructions in this manual.

Front seats

N00401800315

Position the driver's seat as far back as possible while maintaining a position that still enables you to fully apply the pedals, easily control the steering wheel and safely operate the vehicle.

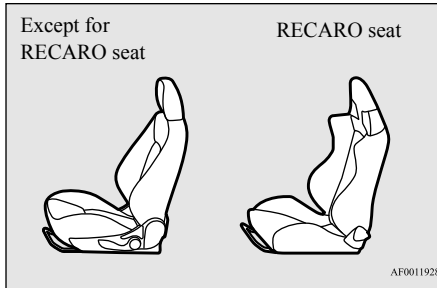

⚠ WARNING

- Do not attempt to adjust the seat while driving. This can cause loss of vehicle control and result in an accident.
- After adjusting the seat, make sure that the seat is securely locked into position.

⚠ WARNING

- To reduce the risk to the driver of serious injury or death during deployment of the driver's airbag, always properly wear the seat belt and adjust the driver's seat as far back as possible while maintaining a position that still enables you to fully apply the pedals, easily control the steering wheel, and safely operate the vehicle.
- To reduce the risk to the front passenger of serious injury or death during deployment of the passenger's airbag, always properly wear the seat belt and adjust the front passenger's seat as far back as possible.
- Always place children 12 years old and under in the rear seat and use appropriate child restraint systems.

⚠ CAUTION

- Make sure that the seat is adjusted by an adult. If it is adjusted by a child, an unexpected accident might occur.
- Do not place a cushion or the like between your back and the seatback while driving. The effectiveness of the head restraints will be reduced in the event of an accident.
- When sliding the seats, be careful not to catch your hand or leg.
- When sliding or reclining the seat rearward, pay careful attention to the rear seat passengers.

Front seats

To adjust the seat forward or backward

N00401900244

Pull the seat adjusting lever up and slide the seat forward or backward to the desired position. Release the adjusting lever to lock the seat in place.

4

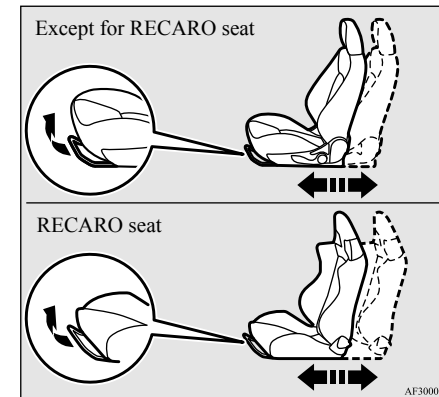

⚠ WARNING

- To make sure that the seat is securely locked, try to move it forward or backward without using the adjusting lever.

Front seats

To adjust the seatback

N00402000297

Except for RECARO seat

4

To adjust the seatback, lean forward slightly, gently pull the seatback lock lever up, then lean backward to a comfortable position and release the lever. The seatback will lock in place.

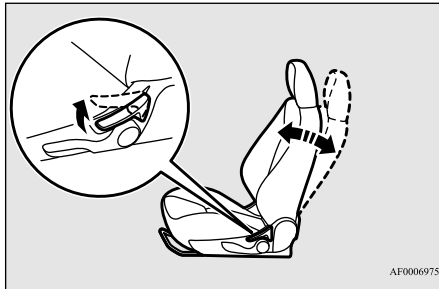

CAUTION

- The reclining mechanism used in the seatback is spring loaded, and will cause the seatback to return quickly to the vertical position when the lock lever is operated. When pulling the lever, sit close to the seatback or hold the seatback with your hand to control its return motion.

RECARO seat

Adjust the seatback angle by turning the dial.

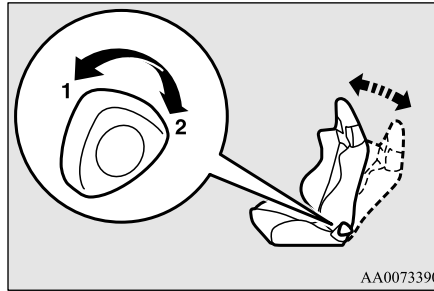

- 1- To move to forward direction
- 2- To recline backward

WARNING

- To reduce the risk of serious injury or death in the event of an accident or sudden stop, all seatbacks should be kept in the upright position while the vehicle is in motion. Seat belt performance during an accident can be adversely affected if the seatbacks are reclined. The more a seatback is reclined, the more likely seat belt performance will be adversely affected. If the seat belt is not properly positioned against the body during an accident, there is increased risk you will slide under the belt and receive serious injury or death.

To adjust the seat height (Driver's side only, if so equipped)

N00402100184

Operate the lever repeatedly to raise or lower the seat.

Rear seats

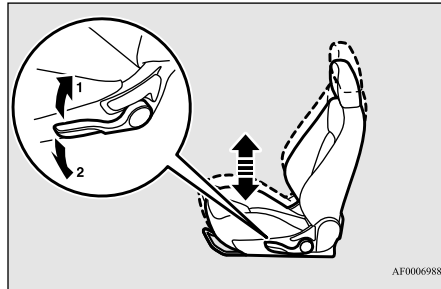

- 1- Raise
- 2- Lower

Heated seats (if so equipped)

N00435600336

The heated seats can be operated when the ignition switch is in the “ON” position.

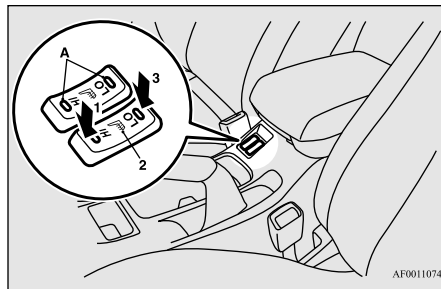

- 1- Heater high (for quick heating)
- 2- Heater off

3- Heater low (to keep the seat warm)

The indicator light (A) will illuminate while the heater is on.

⚠ WARNING

- Persons who are unable to feel temperature change or skin pain due to age, illness, injury, medication, alcohol use, fatigue or other physical conditions or who have sensitive skin may suffer burns when using the heated seat even at low temperatures. To reduce the risk of burns, people with such conditions must use care when using the heated seat.

⚠ CAUTION

- Switch off the seat heaters when not in use. Operate the heaters at high for quick heating. After the seat has become warm, set the heater to low to keep it warm. Slight variations in the seat temperature may be felt while using the heated seats. This is caused by the operation of the heater’s internal thermostat and does not indicate a malfunction.
- Do not place heavy objects on the seat or stick pins, needles, or other pointed objects into the seat.
- Do not place a blanket, cushion, or other insulating material on the seat while using the heater; doing so can cause the heater element to overheat.

⚠ CAUTION

- When cleaning the seat, do not use benzine, kerosene, gasoline, alcohol, or other organic solvents; doing so can cause damage not only to the surface of the seat, but also to the heater.
- If water or any other liquid is spilled on the seat, allow it to dry thoroughly before attempting to use the heater. Turn the heater off immediately if it appears to be malfunctioning during use.

4

Rear seats

N00402500162

Folding the seatbacks forward (if so equipped)

N00402900195

The rear seatbacks can be folded forward to provide additional luggage compartment space.

Push the left and/or right release buttons (A), and fold the rear seatbacks forward. Confirm that the seatback locks securely when it is returned.

Head restraints

4

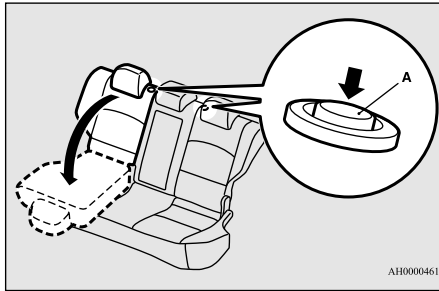

AH0000461

⚠ WARNING

- Do not allow anyone to ride in the luggage compartment while the vehicle is in motion. People who are not properly seated and restrained can be seriously injured or killed in an accident.
- After returning the rear seatbacks to their upright positions, make sure that the seatbacks lock in place and are firmly secured. Also check to be sure that the rear seat belts are in front of the seatbacks, and not caught behind the seatbacks.

⚠ CAUTION

- In the cargo area, do not load the luggage higher than the top of the seats and make sure that the luggage is firmly secured. Restricted rear vision or flying objects entering the passenger compartment during sudden braking can result in a serious accident and injury.

📖 NOTE

- If the seatbacks are returned using too much force, this may cause the center seat belt to lock up. If the seat belt locks up, pull the seat belt once with force and let it retract all the way.

Arm rest (if so equipped)

N00403000294

Tilt the arm rest down for use as shown. The arm rest includes a cup holder. (Refer to “Cup holder” on page 5-190.)

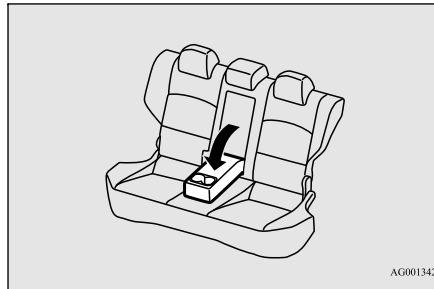

AG0013420

Head restraints

N00404300539

Except for RECARO seat

N00409400030

Padded head restraints for the seats can reduce the risk of a whiplash injury if your vehicle is hit from the rear.

The head restraints are equipped in the illustrated position.

To maximize the effectiveness of your head restraint, adjust the head restraint to the proper position. For the driver and front passenger, adjust the seatbacks to the upright position before adjusting the head restraints. Sit back against the seatback with your head close to the head restraint.

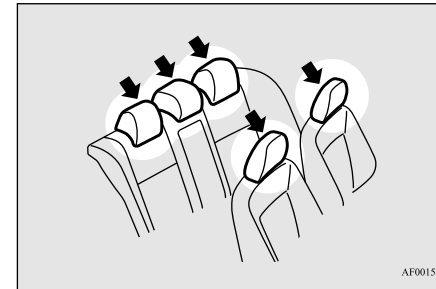

AF0015548

Head restraints

⚠ WARNING

- In order to minimize the risk of a neck injury due to a rear impact, the head restraint must be adjusted to the proper position before vehicle operation. For the driver and front passenger, the seatbacks must be adjusted to the upright position before adjusting the head restraints. The driver should never adjust the seat while the vehicle is in motion.
- Driving without the head restraints in place can cause you and your passengers serious injury or death in an accident. To reduce the risk of injury in an accident, always make sure the head restraints are installed and properly positioned when the seat is occupied.
- Never place a cushion or similar device on the seatback. This can adversely affect head restraint performance by increasing the distance between your head and the restraint.

Adjustment of the head restraint height

To reduce the risk of injury in an accident, adjust the head restraint height so that the center of the restraint is at your eye level when seated. Any person too tall for the restraint to reach their eye level when seated

should raise the restraint to the highest locked position.

- To raise the restraint, pull it straight up.
- To lower the restraint, push down on it while pressing the lock knob (A) in the direction shown by the arrow.
- After adjusting the height, push down on the restraint to make sure it is locked in position.

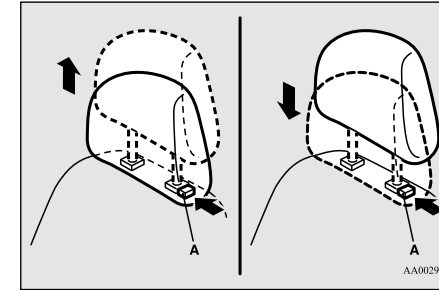
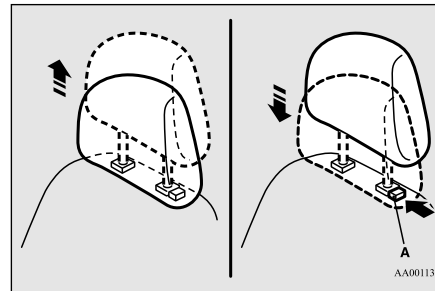

4

⚠ WARNING

- To help minimize the risk of neck injury in the event of an accident, the head restraints must be properly installed and positioned to proper height before vehicle operation.

To install

First check that the head restraint is facing in the right direction as shown in the previous illustration, and then insert it into the seatback. Push the head restraint down while pressing the lock knob (A) until the restraint locks into place.

Seat belts

4

CAUTION

- Check that the lock knob (A) is extended out as shown in the illustration. Then pull the head restraint up to make sure that it is locked in place and will not come out of the seatback.

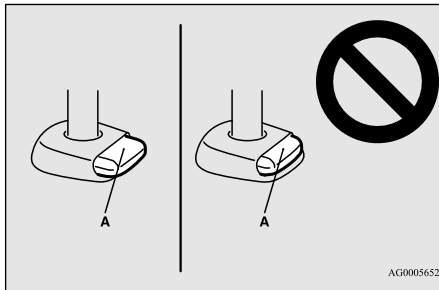

CAUTION

- The shape and size of the head restraint differs according to the seat. Always use the correct head restraint provided for the seat and do not install the head restraint in the wrong direction.

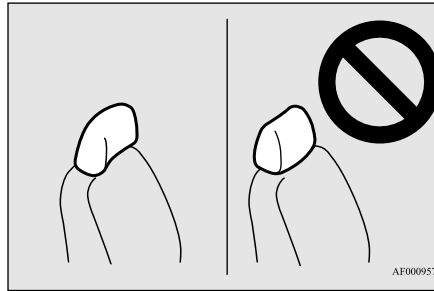

RECARO seat

N00409500044

RECARO seats are equipped with padded head restraints integrated with the seatbacks. These head restraints can reduce the risk of a whiplash injury if your vehicle is hit from the rear.

The head restraints are equipped in the illustrated position.

To maximize the effectiveness of your head restraint, adjust your seatback to the upright position and sit back against the seatback with your head close to the head restraint.

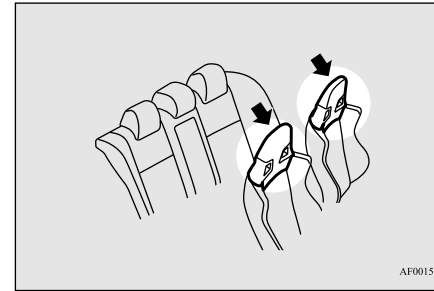

WARNING

- In order to minimize the risk of a neck injury due to a rear impact, the driver and front passenger seatbacks must be adjusted to the upright position before vehicle operation. The driver should never adjust the seat while the vehicle is in motion.
- Never place a cushion or similar device on the seatback. This can adversely affect head restraint performance by increasing the distance between your head and the restraint.

Seat belts

N00406000439

Seat belts are installed in your vehicle to help reduce the risk of injury to the driver and pas-

senger in the event of an accident. Always use the provided seat belts. Carefully review the following information for proper seat belt usage.

⚠ WARNING

- To help reduce the risk of injury or death in an accident, seat belts and child restraint systems must always be used. Refer to “Child restraint systems” on page 4-14 for additional information.
- Never use one seat belt for more than one person.
- Never carry more people in your vehicle than there are seat belts.
- Always adjust the seat belt for a snug fit.
- Always place the shoulder belt over your shoulder and across your chest. Never put it behind you or under your arm.
- Always wear the lap belt as low as possible across your hips, not around your waist.
- Never modify or alter the seat belts in your vehicle.
- To reduce the risk to the driver of serious injury or death during deployment of the driver’s airbag, always properly wear the seat belt and adjust the driver’s seat as far back as possible while maintaining a position that still enables you to fully apply the pedals, easily control the steering wheel, and safely operate the vehicle.

⚠ WARNING

- To reduce the risk to a front seat passenger of serious injury or death from a deploying airbag, make sure the passenger always wears the seat belt properly, remains seated all the way back and upright in their seat, and moves the seat as far back as possible. Refer to “Supplemental Restraint System (SRS) - airbag” on page 4-21 for additional information.
- Never hold an infant or child in your arms or on your lap when riding in this vehicle even when you are wearing your seat belt. Never place any part of the seat belt you are wearing around an infant or child. Failure to follow these simple instructions creates a risk of serious injury or death to your child in the event of an accident or sudden stop.
- Children 12 years old and under should always ride in the rear seat and be properly restrained. This reduces their risk of serious injury or death in an accident, especially due to a deploying front passenger airbag. Refer to “Child restraint systems” on page 4-14 for additional information.

⚠ WARNING

- Any child who is too small to properly wear a seat belt must be properly restrained in an appropriate child restraint system. Children 12 years old and under should be seated only in the rear seat to reduce their risk of serious injury or death in an accident, especially from the deployment of a front passenger airbag.
- Infants **MUST** be placed in a rear-facing child safety seat and positioned in the rear seat.
- In the event of an accident, all seat belt assemblies, including retractors and attachment hardware, should be inspected by an authorized Mitsubishi Motors dealer to determine whether replacement is necessary.

4

Seat belt instructions

N00406201470

All seats are equipped with a seat belt which uses one combined lap-and-shoulder belt with an emergency locking retractor.

This system is designed to provide both comfort and safety. It permits full extension and automatic retraction of the belts during normal vehicle operation. A sensing device inside the belt retractor is designed to lock the retractor in the event of a sudden change in the vehicle’s motion.

Seat belts

4

NOTE

- For instructions on installing a child restraint system using a seat belt, refer to “Installing a child restraint system using the seat belt” on page 4-19.

1. Occupants should always sit back in their seats with their backs against the upright seatback. To reduce the risk of serious injury or death during deployment of the airbag, adjust the driver’s seat as far back as possible while maintaining a position that still enables you to fully apply the pedals, easily control the steering wheel, and safely operate the vehicle. The front passenger seat should also be moved as far back as possible. Refer to “Supplemental Restraint System (SRS) - airbag” on page 4-21. Also refer to “To adjust the seat forward or backward” on page 4-3.

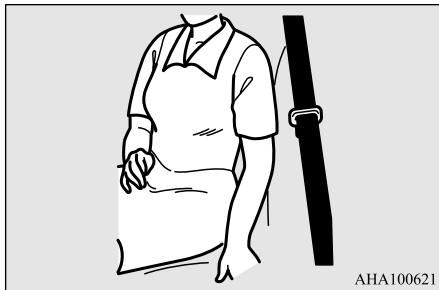

WARNING

- **To reduce the risk of serious injury or death in the event of an accident or sudden stop, all seatbacks should be kept in the upright position while the vehicle is in motion.**
Seat belt performance during an accident can be adversely affected if the seatbacks are reclined. The more a seatback is reclined, the more likely seat belt performance will be adversely affected. If the seat belt is not properly positioned against the body during an accident, there is increased risk you will slide under the belt and receive serious injury or death.

2. Grasp the latch plate and slide it up the webbing so that it easily pulls across your body.



3. Pull the seat belt out slowly while holding the latch plate. Push the latch plate into the buckle until you hear a “click”. Pull up on the belt to be sure the latch plate is locked securely in the buckle.



NOTE

- If the seat belt locks up and cannot be pulled out, pull it once with force and let it retract all the way. Then, pull the belt out slowly once again.

4. The lap part of the belt must always be worn low and snug across the hips. Pull up on the shoulder portion of the belt to take up any slack in the lap belt.

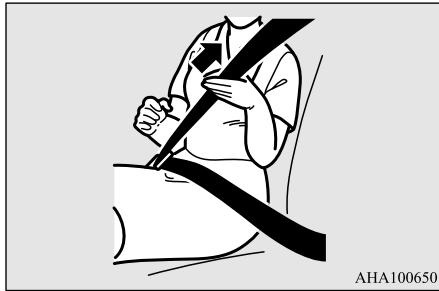

WARNING

- Be sure the seat belt webbing is not twisted when worn. Twisted webbing may adversely affect seat belt performance.

- To release the belt, press the button on the buckle and allow the belt to retract. If the belt does not retract smoothly, pull it out and check for kinks or twists in the webbing. Then make sure it remains untwisted as it retracts.

NOTE

- With the exception of the seat belt for the driver, the seat belts in all other seating positions are equipped with an Automatic Locking Retractor (ALR) function. If you pull the seat belt fully out of the retractor, the retractor will switch to its ALR child restraint installation function (see page 4-19). When the ALR function has been activated, the seat belt will only retract. If this happens, let the belt fully retract, then pull the seat belt back out, repeating steps 1 through 4.

WARNING

- Be sure the lap belt portion fits snugly and is worn as low as possible across the hips, not around the waist. Failure to follow this instruction will increase the risk of serious injury or death in the event of an accident.

Driver's seat belt reminder/warning light and display

N00418400300

Warning light



Warning display type 1



Warning display type 2



4

A tone and warning light are used to remind the driver to fasten the seat belt.

If the ignition switch is set to the "ON" position without the driver's seat belt being fastened, a warning light will come on and a tone will sound for approximately 6 seconds to remind you to fasten your seat belt.

If you then drive with the seat belt unfastened for longer than a minute from when the ignition switch was turned on, the warning light will come on and blink repeatedly and the tone will sound intermittently.

The warning light and the tone will stop after approximately 90 seconds.

If you then repeatedly stop and start your vehicle with the seat belt unfastened, the warning light/display and tone will remind you to fasten your seat belt every time the vehicle starts moving. You will also be reminded to fasten your seat belt in this way when you remove your seat belt while driving. The warning light and the tone go off when the seat belt is fastened.

Seat belts

4

⚠ WARNING

- In order to reduce the risk of serious injury or death in an accident, always wear your own seat belt. Do not allow anyone to ride in your vehicle unless he or she is also seated and wearing a seat belt. Children should additionally be restrained in a secure child restraint system.

📖 NOTE

- At the same time, “FASTEN SEAT BELT” will be displayed on the information screen in the multi-information display.

Front passenger seat belt warning light

N00418300165

The front passenger seat belt warning light is located in the instrument panel.

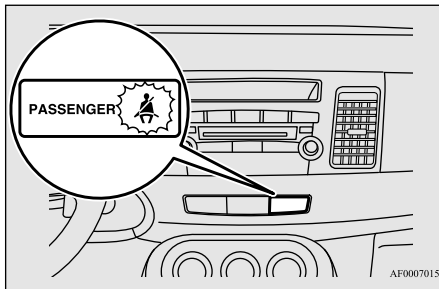

AF0007015

When the key is turned to the “ON” position, this indicator normally comes on and goes off a few seconds later.

The light comes on when a person sits on the front passenger seat but does not fasten the seat belt. It goes off when the seat belt is subsequently fastened.

⚠ WARNING

- Do not install any accessory or sticker that makes the light difficult to see.

Adjustable seat belt shoulder anchor (front seats)

N00406300315

To move the anchor down, press the lock knob (A) and slide the anchor down to the desired position.

To move the anchor up, slide the anchor up to the desired position.

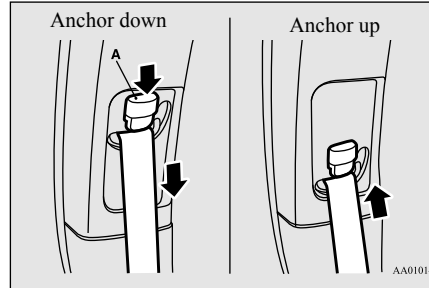

⚠ WARNING

- Always adjust the shoulder belt anchor so that the shoulder belt is positioned across the center of your shoulder without touching your neck. The shoulder belt should not be able to fall off your shoulder. Failure to follow this instruction can adversely affect seat belt performance and increase the risk of serious injury or death in the event of an accident.
- Adjust the shoulder belt anchor only when the vehicle is not in motion.
- Make sure the anchor is securely locked in position after adjusting it.

Seat belt extender

N00406701215

When your seat belt, even fully extended, is not long enough, a seat belt extender must be

obtained. The extender may be used for either of the front seats.

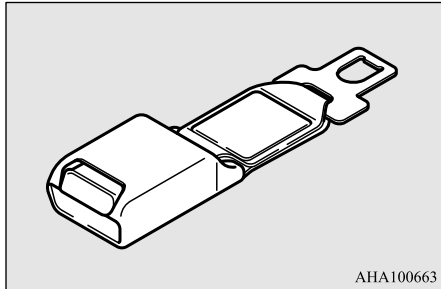

AHA100663

⚠ WARNING

- The extender should only be used if the existing belt is not long enough. Anyone who can use the standard seat belt should not use an extender. Unnecessary use of an extender can adversely affect seat belt performance in an accident.
- When not required, the extender must be removed and stowed.

Seat belt use during pregnancy

N00406800121

Seat belts work for everyone, including pregnant women. Like all occupants, pregnant women are more likely to be seriously injured

or killed in an accident if they do not wear seat belts.

⚠ WARNING

- To reduce the risk of serious injury or death to pregnant women and unborn children in an accident, pregnant women should always wear a seat belt. The lap portion of the seat belt should be worn snug and low across the hips and below the rounding. Consult your doctor if you have any additional questions or concerns.

Seat belt pre-tensioner and force limiter systems

N00417700609

The driver's and front passenger's seats each have a seat belt equipped with a pre-tensioner system.

Pre-tensioner system

The driver and front passenger seat belts are equipped with a seat belt pre-tensioner system. In a moderate-to-severe frontal or side collision, the pre-tensioner system operates simultaneously with the deployment of the front airbags or side airbags and curtain airbags.

Seat belt use during pregnancy

The seat belt pre-tensioners are located within the seat belt retractors (A). When activated, the pre-tensioners quickly draw back seat belt webbing and increase seat belt performance.

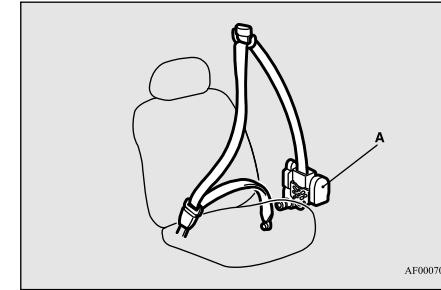

AF0007031

4

The seat belt pre-tensioner system includes the following components:

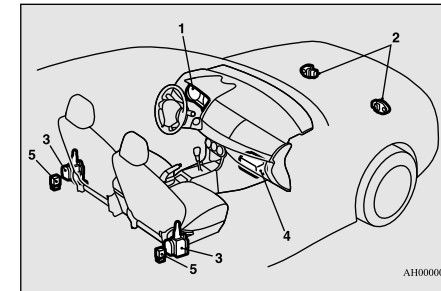

AH0000041

- 1- SRS warning light
- 2- Front impact sensors
- 3- Seat belt pre-tensioners

Child restraint systems

- 4- Airbag control unit
- 5- Side impact sensors

4

The airbag control unit monitors the readiness of the electronic parts of the system whenever the ignition switch is in the “ON” or “START” position. These include all of the items listed above and all related wiring.

The pre-tensioner seat belt system will operate only when the ignition switch is in the “ON” or “START” position.

When the seat belt pre-tensioners activate, some smoke is released and a loud noise will be heard. The smoke is not harmful, but care should be taken not to intentionally inhale it, as it may cause some temporary irritation to people with respiratory problems.

The pre-tensioners activate in the event of a moderate-to-severe frontal or side impact, even if the seat belt is not being worn. The seat belt pre-tensioners may not activate in certain types of collisions, even though the vehicle may appear to be severely damaged. Such non-activation does not mean something is wrong with the seat belt pre-tensioner system, but rather that the collision forces were not severe enough or not of the type to activate the system.

⚠ WARNING

- **The seat belt pre-tensioner system is designed to work only once. After the seat belt pre-tensioners have been activated, they will not work again. They must promptly be replaced and the entire seat belt pre-tensioner system inspected by an authorized Mitsubishi Motors dealer.**

SRS warning

N00408700094

This warning tells you if there is a problem involving the SRS airbags and the pre-tensioner seat belts. Refer to “SRS warning” on page 4-27.

Force limiter system

N00408900113

In the event of an accident, the seat belt force limiter system will help reduce the force applied to the driver and front seat passenger.

Child restraint systems

N00407101766

When transporting infants or small children in your vehicle, an appropriate child restraint system must always be used. This is required by law in the U.S. and Canada.

Child restraint systems specifically designed for infants and small children are offered by several manufacturers. Choose only a child restraint system with a label certifying that it complies with Federal Motor Vehicle Safety Standard 213 (FMVSS 213) or Motor Vehicle Restraint Systems and Booster Seats Safety Regulations (RSSR). Look for the manufacturer’s statement of compliance on the box and child restraint system itself.

The child restraint system should be appropriate for your child’s weight and height, and should properly fit your vehicle’s seat.

For detail information, refer to the instruction manual accompanying the child restraint system.

Guidelines for child restraint system selection

All children should be properly restrained in a restraint device that offers the maximum protection for their size and age.

Be sure to check local, state, or provincial requirements for child size and age that may vary from the recommendations listed below.

- Children less than 1 year old and who weigh 22 pounds (10 kg) or less **MUST** ride in a rear-facing child safety seat that **MUST ONLY** be used in the rear seat.

Child restraint systems

- Children older than 1 year of age and who weigh less than 40 pounds (18 kg) or who are less than 40 inches (100 cm) tall must be in a forward-facing restraint used only in the rear seat.
- Children who weigh more than 40 pounds (18 kg) or who are more than 40 inches (100 cm) tall, regardless of age, should use a suitable child seat or a booster seat in the rear seat until the vehicle's lap/shoulder belt fits them properly.

WARNING

- All children must be seated in the rear seat, and properly restrained. Accident statistics show that children of all sizes and ages are safer when properly restrained in the rear seat, rather than in the front seat.

WARNING

- Any child who is too large to use a child restraint system should ride in the rear seat and wear the lap and shoulder belt properly. The shoulder belt must be positioned over the shoulder and across the chest, not across their neck, and with the lap belt positioned low on the child's hips, not across their stomach. If necessary, a booster seat should be used to help achieve a proper seat belt fit. Follow the booster seat manufacturer's instructions. Only use a booster seat that is certified as complying with Federal Motor Vehicle Safety Standards or Motor Vehicle Restraint Systems and Booster Seats Safety Regulations.
- Never hold an infant or child in your arms or on your lap when riding in this vehicle, even when you are wearing your seat belt. Never place any part of the seat belt you are wearing around an infant or child. Failure to follow these simple instructions creates a risk of serious injury or death to your child in the event of an accident or sudden stop.



4

WARNING

- Your vehicle is also equipped with a front passenger airbag. Never put REAR-FACING CHILD RESTRAINT SYSTEMS or INFANT RESTRAINT SYSTEMS in the front passenger seat. This places the infant too close to the passenger airbag. During deployment of the airbag, the infant can be seriously injured or killed. Rear-facing child restraint systems or infant restraint systems must only be used in the rear seat.

Child restraint systems

4



⚠ WARNING

● **FRONT-FACING CHILD RESTRAINT SYSTEMS** should be used in the rear seat whenever possible. If they must be used in the front passenger seat, move the seat to the most rearward position and make sure the child stays in the child restraint system, properly restrained. Failure to follow these instructions could result in serious injury or death to the child.



⚠ WARNING

- It is important to use an approved rear-facing infant restraint until the infant is one year old (unless the infant outgrows the seat sooner). This allows the infant's neck and spine to develop enough to support the weight of their head in the event of an accident.
- When installing a child restraint system, follow the instructions provided by the manufacturer and follow the directions in this manual. Failure to do so can result in serious injury or death to your child in an accident or sudden stop.
- After installation, push and pull the child restraint system back and forth, and side to side, to see that it is firmly secured. If the child restraint system is not installed securely, it may cause injury to the child or other occupants in the event of an accident or sudden stop.
- When not in use, keep your child restraint system secured with the seat belt, or remove it from the vehicle, in order to prevent it from being thrown around inside the vehicle during an accident.

📖 NOTE

- Before purchasing a child restraint system, try installing it in the rear seat to make sure there is a good fit. Because of the location of the seat belt buckles and the shape of the seat cushion, it may be difficult to securely install some manufacturer's child restraint systems. If the child restraint system can be pulled forward or to either side easily on the seat cushion after the seat belt has been tightened, choose another manufacturer's child restraint system.
- Depending on the seating position in the vehicle and the child restraint system that you have, the child restraint system can be attached using one of the following two methods:
- To the lower anchorage in the rear seat **ONLY** if the child restraint system is compatible with the LATCH system (See page 4-17).
 - To the seat belt (See page 4-19).

Installing a child restraint system using the LATCH (Lower Anchors and Tethers for children) system

N00418800131

Lower anchor locations

The outboard seating positions in the rear seat of your vehicle are equipped with lower anchors for attaching child restraint systems compatible with the LATCH system.

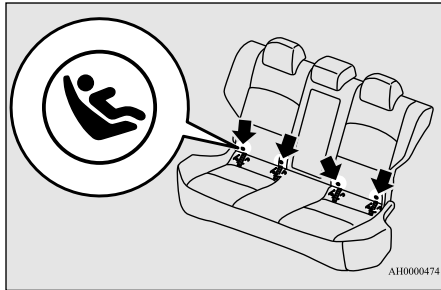

AH0000474

NOTE

- The symbols on the seatback show the location of the lower anchor points.

Tether anchor locations

N00418900129

Your vehicle has 3 attachment points on the rear shelf, located behind the top of your rear seat. These are for securing a child restraint system tether strap to each of the 3 rear seating positions in your vehicle.

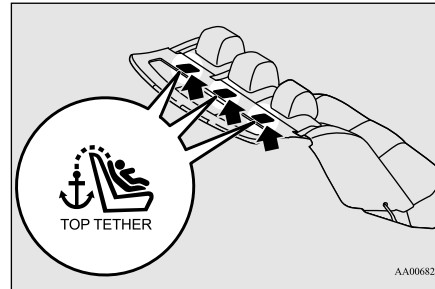

AA0068246

Examples of child restraint systems compatible with the LATCH system

N00419000185

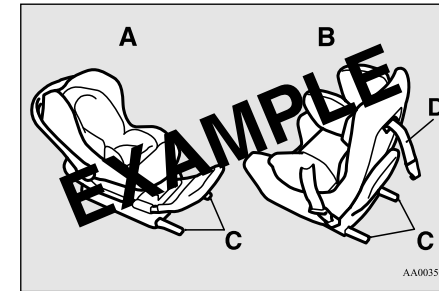

AA0035044

- A- Rear-facing child restraint system
- B- Front-facing child restraint system
- C- Child restraint system lower anchor connectors
- D- Tether strap (These are only examples.)

4

Using the LATCH system

N00419100157

1. In order to securely fasten the tether strap, remove the head restraint from the location where you wish to install the child restraint system.

Child restraint systems

4

2. Push the anchor connectors (A) on the child restraint system into the slits (B) in accordance with the instructions provided by the child restraint system manufacturer. Remember, the lower anchors (E) provided with your vehicle are designed to secure suitable child restraint systems compatible with the LATCH system in the rear seat only.

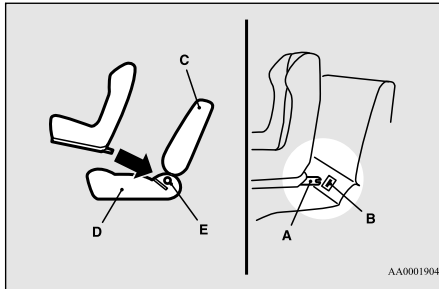

- A- Connector D- Vehicle seat cushion
 B- Slit E- Lower anchor
 C- Vehicle seatback

NOTE

- In order to secure a child restraint system compatible with the LATCH system, use the lower anchor points in the outboard positions of the rear seat. It is not necessary to use the vehicle's seat belt. The vehicle's seat belt, however, **MUST** be used to secure a child restraint system in the center position of the rear seat.

WARNING

- If there is any foreign material in or around the lower anchors, remove it before installing the child restraint system. Also, make sure the seat belt is away from, not looped through or otherwise interfering with, the child restraint system. If foreign matter is not removed and/or the seat belt interferes with the child restraint system, the child restraint system will not be secured properly, could detach and move forward in the event of sudden braking or an accident, and could result in injury to the child or other vehicle occupants.
- When the vehicle is moving, do not adjust the seat where the child restraint system is installed.

3. Open the cover for the tether anchor by pulling it back with your hand as illustrated below (3).

4. Latch the tether strap hook (F) of the child restraint system to the anchor (G) as illustrated below (4) and tighten the top tether strap so it is securely fastened.

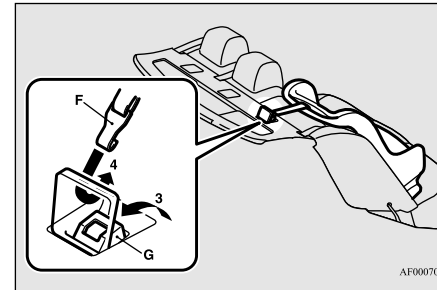

5. Push and pull the child restraint system in all directions to be sure it is firmly secured.

WARNING

- Child restraint system tether anchors are designed only to withstand loads from correctly fitted child restraint systems. Under no circumstances are they to be used for adult seat belts, or harnesses, or for attaching other items or equipment to the vehicle.

Installing a child restraint system using the seat belt (with emergency/automatic locking mechanism)

N00407301508

With the exception of the driver, the seat belt in all other seating positions can be converted from normal Emergency Locking Retractor (ELR) mode to Automatic Locking Retractor (ALR) mode. This means that when you pull the seat belt fully out of the retractor, the retractor will switch to its ALR child restraint installation function. Always use the ALR child restraint installation function when you install a child restraint system using the seat belt.

Children 12 years old and under should always be restrained in the rear seat, whenever possible, although the front passenger seat belt can also be converted to ALR mode.

WARNING

- When you install a child restraint system using the seat belt, always make sure the retractor has been switched to the ALR child restraint installation function. The ALR function will keep the child restraint system tightly secured to the seat. Failure to convert the retractor to the ALR function may allow the child restraint system to move forward during sudden braking or an accident, resulting in serious injury or death to the child or other occupants.

Installation

1. Place the child restraint system on the seat where you wish to install it.
To help assure proper fitting of the child restraint system, always remove the head restraint.
2. Route the seat belt through the child restraint system according to the instructions provided by the child restraint system manufacturer. Then insert the seat belt latch plate into the buckle. Make sure you hear a “click” when you insert the latch plate into the buckle.

Child restraint systems

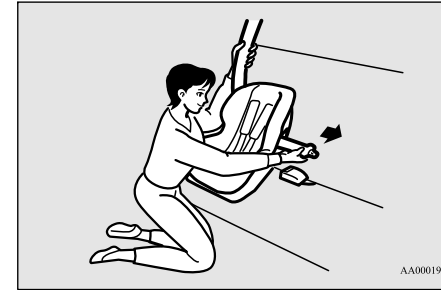

4

3. To activate the ALR child restraint installation function, slowly pull the shoulder part of the belt all the way out of the retractor until it stops. Then let the belt feed back into the retractor.

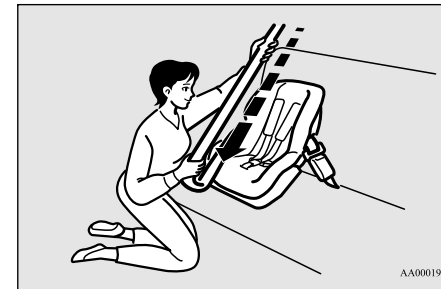

Child restraint systems

4

4. After the belt has retracted, tug on it. If the belt is in the ALR function, you will not be able to pull it out. If the webbing can be pulled out from retractor, the ALR function has not been activated and you will need to repeat steps 3 and 4.
5. After confirming that the belt is locked, grab the shoulder part of the belt near the buckle and pull up to remove any slack from the lap part of the belt allowing the slack to feed into the retractor. Remember, if the lap belt portion is not tight, the child restraint system will not be secure. It may help to put your weight on the child restraint system and/or push on its seat-back while pulling up on the belt (see illustration).

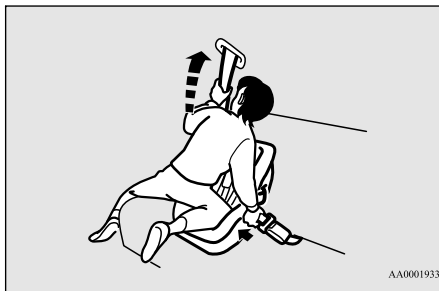

If your child restraint system requires the use of a tether strap, fasten the tether strap in accordance with the following procedures.

6. Open the cover from the tether anchor installation point by pulling it back with your hand as illustrated below (6).
7. Latch the tether strap hook (A) of the child restraint system to the tether anchor (B) as illustrated below (7) and tighten the top tether strap so it is securely fastened.

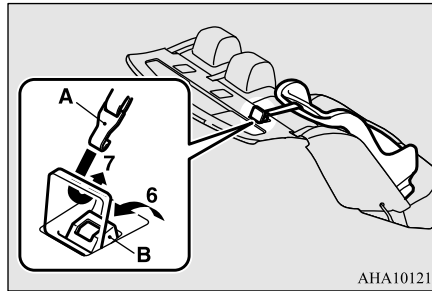

WARNING

- Child restraint system tether anchors are designed only to withstand loads from correctly fitted child restraint systems. Under no circumstances are they to be used for adult seat belts, or harnesses, or for attaching other items or equipment to the vehicle.

8. Before putting your child in the restraint, push and pull the restraint in all directions to be sure it is firmly secured. Do this before each use. If the child restraint system is not firmly secure, repeat steps 1 through 7.
9. To remove a child restraint system from the vehicle and deactivate the ALR mode, remove the child from the restraint. Unlatch the buckle. Then remove the belt from the restraint and let the belt fully retract.
10. Reinstall the head restraint.
Refer to “Head restraints” on page 4-6.

Children who have outgrown child restraint systems

N00407601644

Children who have outgrown a child restraint system should be seated in the rear seat and wear the seat belt. If the shoulder belt crosses their face or neck, and/or the lap belt crosses their stomach, a commercially available booster seat must be used, to raise the child so that the shoulder belt crosses their shoulder and the lap belt remains positioned low across their hips. The booster seat should fit the vehicle seat and have a label certifying compliance with Federal Motor Vehicle Safety Standards or Motor Vehicle Restraint

Systems and Booster Seats Safety Regulations.

⚠ WARNING

- Any child who is too small to properly wear a seat belt must be properly restrained in an appropriate child restraint system, to reduce their risk of serious injury or death in an accident.
- A child should never be left unattended in, or unsupervised, around your vehicle. When you leave the vehicle always take the child out as well.
- Children can die from heat stroke if left or trapped inside the vehicle, especially on hot days.
- Keep your vehicle locked and the trunk lid closed when not in use. Keep your vehicle keys away from children.
- Never allow children to play in the trunk of your vehicle.

Maintenance and inspection of seat belts

N00407000221

The seat belt webbing may be cleaned with mild soap or detergent solution. Do not use an organic solvent. Allow the belts to dry in the shade. Do not allow them to retract until completely dry. Do not attempt to bleach or re-

dye the belts. The color may rub off and the webbing strength may be affected.

Regularly check your seat belt buckles and their release mechanisms for positive engagement and release of the latch plate. Check the retractors for automatic locking when in the Automatic Locking Retractor function.

The entire seat belt assembly should be replaced if the webbing shows any obvious cuts, tears, increase in thickness in any section of the webbing from broken fibers, or severe fading from sunlight. All of these conditions indicate a weakening of the belt, which may adversely affect seat belt performance in an accident.

⚠ WARNING

- Do not attempt to repair or replace any part of the seat belt assemblies. This work should be done by an authorized Mitsubishi Motors dealer. Failure to have an authorized Mitsubishi Motors dealer perform the work could reduce the effectiveness of the belts and could result in a serious injury or death in an accident.

Maintenance and inspection of seat belts

Supplemental Restraint System (SRS) - airbag

N00407701805

4

This vehicle is equipped with a Supplemental Restraint System (SRS), which includes airbags for the driver and passengers.

The SRS front airbags are designed to supplement the primary protection of the driver and front passenger seat belt systems by providing those occupants with protection against head and chest injuries in certain moderate to severe frontal collisions.

The SRS front airbags, together with sensors at the front of the vehicle and sensors attached to the front seats, form an advanced airbag system.

The SRS driver's knee airbag is designed to supplement the primary protection of the driver's seat belt system. It can reduce the forward movement of the driver's lower legs and provide increased overall body protection in certain moderate to severe frontal collisions.

The SRS side airbags (if so equipped) and the curtain airbags (if so equipped) are also designed to supplement the seat belts. The SRS side airbags provide the driver and front passenger with protection against chest injuries by deploying the bag on the side

Supplemental Restraint System (SRS) - airbag

4

impacted in moderate to severe side impact collisions. The SRS curtain airbags provide the driver and passengers on the front seat and rear outboard seat with protection against head injuries by deploying a bag on the side impacted in moderate to severe side impact collisions.

The SRS airbags are NOT a substitute for use of the seat belts. For maximum protection in all types of accidents, seat belts must ALWAYS be worn by everyone who drives or rides in this vehicle (with infants and small children in an appropriate child restraint system in the rear seat, and older children buckled in the rear seat). Refer to “Child restraint systems” on page 4-14.

WARNING

- IT IS VERY IMPORTANT TO ALWAYS WEAR YOUR SEAT BELT PROPERLY EVEN WITH AN AIRBAG.

WARNING

- Seat belts help keep the driver and passengers properly positioned. This reduces the risk of injury in all collisions, and reduces the risk of serious injuries or death when the airbags inflate. During sudden braking just before a collision, an unrestrained or improperly restrained driver or passengers can move forward into direct contact with, or within close proximity to, the airbag when it begins to inflate. The beginning stage of airbag inflation is the most forceful and can cause serious injuries or death if the occupant comes in contact with the airbag at this time.
- Seat belts reduce the risk of injury in rollovers, rear impact collisions, and in lower-speed frontal collisions, because the airbags are not designed to inflate in those situations.
- Seat belts reduce the risk of being thrown from your vehicle in a collision or rollover.
- IT IS VERY IMPORTANT TO BE PROPERLY SEATED.
 - A driver or front passenger sitting too close to the steering wheel or instrument panel during airbag deployment can be seriously injured or killed.

WARNING

- Airbags inflate very quickly and with great force. If the driver and front passenger are not properly seated and restrained, the airbag may not provide the proper protection and can cause serious injuries or death when it inflates.
- To reduce the risk to the driver of serious injury or death due to a deploying driver's airbag, always properly wear your seat belt and adjust the driver's seat as far back as possible, maintaining a position that still allows the driver to have good control of the steering wheel, brake, accelerator, and other vehicle controls.
- To reduce the risk to the front passenger of serious injury or death from a deploying passenger's airbag, make sure the passenger always wears the seat belt properly, remains seated upright and all the way back in the seat, and positions the seat as far back as possible.
- Seat all infants and children in the rear seat, properly restrained in an appropriate child restraint system.
- Airbags inflate very quickly and with great force. Do not sit on the edge of the seat or sit with your lower legs too close to the instrument panel, or lean your head or chest close to the steering wheel or the instrument panel.
- Do not put your feet or legs on or against the instrument panel.

Supplemental Restraint System (SRS) - airbag

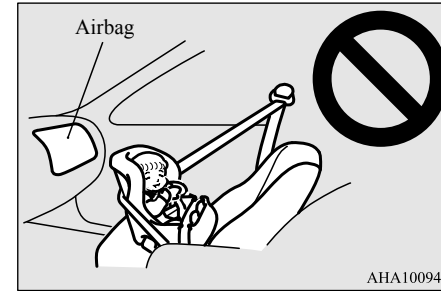
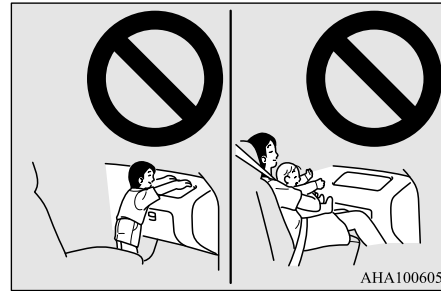
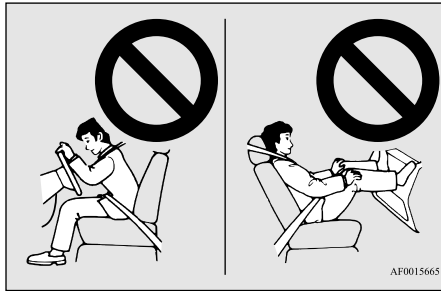

4

⚠ WARNING

- Infants and small children should never ride unrestrained, or lean against the instrument panel. They should never ride held in your arms or on your lap. They can be seriously injured or killed in an accident, especially when the airbags inflate. Infants and children should be properly seated in the rear seat in an appropriate child restraint system. Refer to “Child restraint systems” on page 4-14.

⚠ WARNING

- NEVER put REAR-FACING CHILD RESTRAINT SYSTEMS or INFANT RESTRAINT SYSTEMS in the front passenger seat. This places the infant too close to the passenger airbag. During deployment of the airbag, the infant can be seriously injured or killed. Rear-facing child restraint systems or infant restraint systems must only be used in the rear seat.

⚠ WARNING

- FRONT-FACING CHILD RESTRAINT SYSTEMS should be used in the rear seat whenever possible. If they must be used in the front passenger seat, move the seat to the most rearward position and make sure the child stays in the child restraint system, properly restrained. Failure to follow these instructions could result in serious injury or death to the child.



Supplemental Restraint System (SRS) - airbag

⚠ WARNING

- Older children should be seated in the rear seat with their seat belt properly worn, and with an appropriate booster seat if needed. Refer to “Children who have outgrown child restraint systems” on page 4-20.

4

How the Supplemental Restraint System works

N00407800506

The SRS includes the following components:

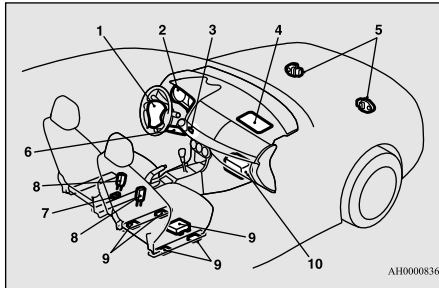

- 1- Driver's airbag
- 2- SRS warning light
- 3- Passenger's airbag off indicator
- 4- Passenger's front airbag
- 5- Front impact sensors
- 6- Driver's knee airbag
- 7- Driver's seat position sensor

- 8- Seat belt buckle switches (vehicles with turbocharger only)
- 9- Passenger's seat weight sensors
- 10- Airbag control unit

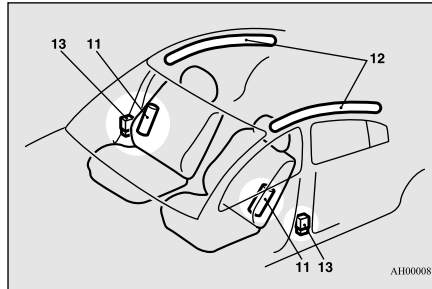

- 11- Side airbag modules
- 12- Curtain airbag modules
- 13- Side impact sensors

The airbag control unit monitors the readiness of the electronic parts of the system whenever the ignition switch is in the “ON” or “START” position. These include all of the items listed above and all related wiring.

The airbags will operate only when the ignition switch is in the “ON” or “START” position.

When the impact sensors detect a front or side impact sufficient to deploy the airbag(s), the appropriate airbag(s) will be deployed.

When airbags deploy, some smoke is released accompanied by a loud noise. The smoke is not harmful, but do not intentionally inhale the smoke as it may cause temporary irritation to people with respiratory problems.

After deployment, the airbags will quickly deflate, so quickly that some people may not even realize the airbags inflated.

Airbag inflation does not prevent the driver from seeing or being able to steer the vehicle, and does not prevent people from leaving the vehicle.

⚠ CAUTION

- Airbags inflate very quickly and with great force. In certain situations, contact with an inflating airbag may cause small cuts, abrasions, and bruises. Refer to “Supplemental Restraint System (SRS) - airbag” on page 4-21.

Event Data Recording

N00418600230

This vehicle is equipped with an event data recorder (EDR).

The main purpose of an EDR is to record, in certain crash or near crash-like situations, such as an airbag deployment or hitting a road obstacle, data that will assist in understanding how a vehicle's systems performed.

Supplemental Restraint System (SRS) - airbag

The EDR is designed to record data related to vehicle dynamics and safety systems for a short period of time, typically 30 seconds or less.

The EDR in this vehicle is designed to record such data as:

- How various systems in your vehicle were operating;
- Whether or not the driver and passenger safety belts were buckled/fastened;
- How far (if at all) the driver was depressing the accelerator and/or brake pedal; and,
- How fast the vehicle was traveling.

These data can help provide a better understanding of the circumstances in which crashes and injuries occur.

 **NOTE**

- EDR data are recorded by your vehicle only if a non-trivial crash situation occurs; no data are recorded by the EDR under normal driving conditions and no personal data (e.g., name, gender, age, and crash location) are recorded. However, other parties, such as law enforcement, could combine the EDR data with the type of personally identifying data routinely acquired during a crash investigation.

To read data recorded by an EDR, special equipment is required, and access to the vehicle or the EDR is needed. In addition to the vehicle manufacturer, other parties, such as law enforcement, that have the special equipment, can read the information if they have access to the vehicle or the EDR.

Driver's seat position sensor

N00417900164

The driver's seat position sensor is attached to the seat rail and provides the airbag control unit with information on the seat's fore-aft position. The airbag control unit controls deployment of the driver's front airbag in accordance with the information it receives from this sensor.

If there is a problem involving the driver's seat position sensor, the SRS warning in the instrument panel will come on. Refer to "SRS warning" on page 4-27.

 **WARNING**

- **If the SRS warning comes on, have the vehicle inspected by an authorized Mitsubishi Motors dealer as soon as possible.**
- **Please observe the following instructions to ensure that the driver's seat position sensor can operate correctly.**
 - **Adjust the seat to the correct position, and sit well back against the seatback. Refer to "Front seats" on page 4-3.**

 **WARNING**

- **Do not recline the seatback more than necessary when driving.**
- **Do not place metallic objects or luggage under the front seat.**
- **If the vehicle is involved in a severe impact, have the SRS sensor inspected by an authorized Mitsubishi Motors dealer as soon as possible.**

4

Passenger's seat weight sensors

N00418000247

The passenger's seat weight sensors are attached to the seat rails and provide the airbag control unit with information regarding the weight on the front passenger seat. The airbag control unit controls deployment of the passenger's front airbag in accordance with the information it receives from this sensor.

The passenger's front airbag will not deploy in an impact when the weight on the seat is sensed to be less than approximately 66 pounds (30 kg). In this case, the passenger's airbag off indicator will come on. Refer to "Passenger's airbag off indicator" on page 4-26.

If there is a problem involving the passenger's seat weight sensors, the SRS warning in the instrument panel will come on. Refer to "SRS warning" page 4-27.

Supplemental Restraint System (SRS) - airbag

4

WARNING

- If any of the following conditions occur, you should immediately have your vehicle inspected by an authorized Mitsubishi Motors dealer as soon as possible:
 - The SRS warning does not initially come on when the ignition switch is turned to the “ON” or “START” position.
 - The SRS warning does not go out after several seconds.
 - The SRS warning comes on while you are driving.
- To ensure that the passenger’s seat weight sensors can correctly sense the weight being applied to the seat, observe the following instructions. Failure to follow these instructions can adversely affect the performance of the passenger’s airbag system.
 - Adjust the seat to the correct position, and sit well back against the seatback. Refer to “Front seats” on page 4-3.
 - Do not recline the seatback more than necessary.
 - Never have more than one person (adult or child) sitting on the seat.
 - Do not place anything between the seat and the floor console.
 - Do not hang anything on the front passenger’s seatback.
 - Do not remove the head restraints.
 - When attaching a child restraint system, secure it firmly.

WARNING

- Do not place luggage or other objects on the seat.
- Do not use a seat cover or a cushion.
- Do not modify or replace the seat and seat belt.
- Do not place luggage or other objects under the seat.
- Do not place the floor mat on the seat rails.
- Do not expose the sensors to liquids or vapors.
- Do not subject the sensors to shock.
- Do not allow rear-seat occupants to push the front passenger seat with their feet or force the front passenger seat upward.
- Do not allow rear-seat occupants to grasp the front passenger’s seatback or put their arms around it.
- When attaching a child restraint system in the rear seat, make sure it does not interfere with the front seat.
- If the vehicle is involved in a severe impact, have the SRS sensors inspected by an authorized Mitsubishi Motors dealer as soon as possible.

Passenger’s airbag off indicator

N00418100277

The passenger’s airbag off indicator is located in the instrument panel.

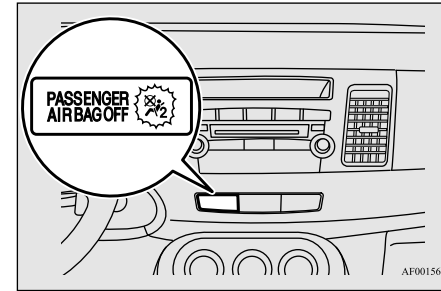

The indicator normally comes on when the ignition switch is turned to the “ON” position and goes out a few seconds later.

In the following situations, the indicator will stay on to show that the passenger’s front airbag is not operational.

- The passenger’s seat weight sensors sense a weight of less than approximately 66 pounds (30 kg) on the front passenger seat.
- The front passenger’s seat is not occupied.

When the weight applied to the front passenger seat is sensed to be approximately 66 pounds (30 kg) or greater, the indicator goes out to show that the passenger’s front airbag is operational.

Supplemental Restraint System (SRS) - airbag

! WARNING

- If any of the following conditions occur, you should immediately have the airbag system in your vehicle inspected by an authorized Mitsubishi Motors dealer as soon as possible:
 - The passenger's airbag off indicator comes on when an adult is sitting on the front passenger seat.
 - The passenger's airbag off indicator does not come on when the front passenger's seat is not occupied.
 - The passenger's airbag off indicator does not come on when the ignition switch is turned to the "ON" position.
 - The passenger's airbag off indicator comes on and goes out repeatedly.
- Do not attach any accessory to your vehicle that makes the passenger's airbag off indicator difficult or impossible to see. You must be able to see the passenger's airbag off indicator and verify the status of the passenger's airbag system.

SRS warning light/display

N00408301619

Warning light



Warning display type 1



Warning display type 2



The system checks itself every time the ignition switch is turned to the "ON" position. The SRS warning light will come on for several seconds and then go out. This is normal and means the system is working properly. If there is a problem involving one or more of the SRS components, the warning light will come on and stay on. At the same time, the warning display will appear on the information screen in the multi information display. The SRS warning light/display is shared by the SRS airbag and the seat belt pre-tensioner system.

! WARNING

- If any of the following conditions occur, there may be a problem with the SRS airbags and/or seat belt pre-tensioners, and they may not function properly in a collision or may suddenly activate without a collision:
 - Even when the ignition switch is in ON, the SRS warning light does not come on or it remains on.
 - The SRS warning light and/or the warning display comes on while driving.
- The SRS airbags and seat belt pre-tensioners are designed to help reduce the risk of serious injury or death in certain collisions.
- If either of the above conditions occurs, immediately have your vehicle checked by an authorized Mitsubishi Motors dealer.

4

Driver's and passenger's front airbag system

N00407900318

The driver's airbag is located under the padded cover in the middle of the steering wheel. The front passenger's airbag is contained in the instrument panel above the glove compartment. The driver's airbag and the front passenger's airbag are designed to deploy at the same time. However, the front passenger's airbag does not deploy when the front

Supplemental Restraint System (SRS) - airbag

passenger seat is not occupied or when the weight sensor in the front passenger seat senses a weight on the seat of less than approximately 66 pounds (30 kg).

4

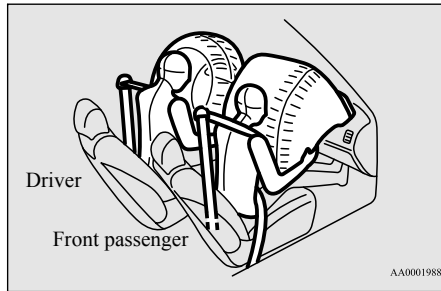

Driver's knee airbag system

N00404500010

The driver's knee airbag is located under the steering wheel. The driver's knee airbag is designed to deploy at the same time as the driver's front airbag.

Deployment of front airbags

N0040800521

The front airbags and driver's knee airbag ARE DESIGNED TO DEPLOY when...

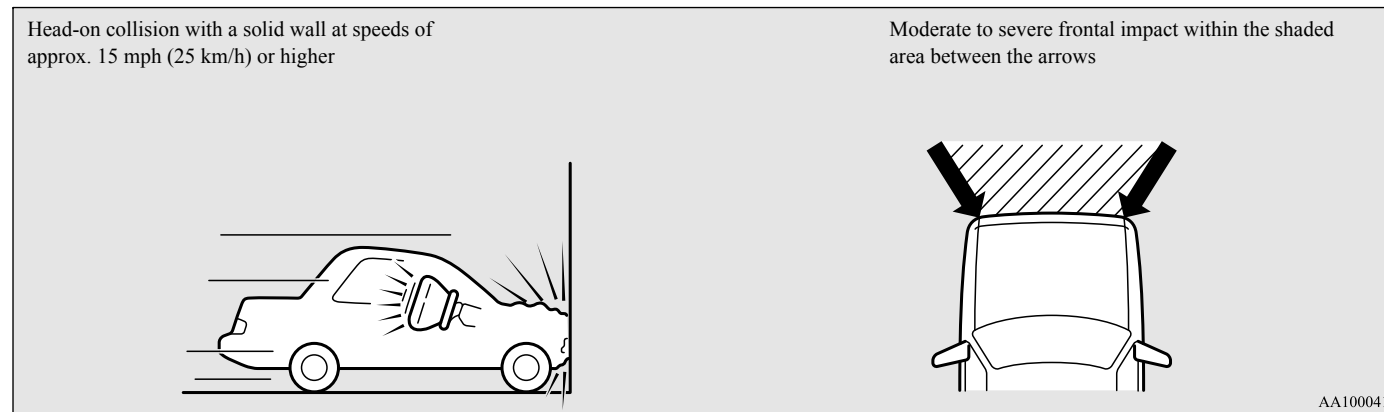

4

The front airbags and driver's knee airbag are designed to deploy when the vehicle suffers a moderate to severe frontal impact. A typical condition is shown in the illustration to the left.

The front airbags and driver's knee airbag are designed to deploy only in certain moderate to severe frontal collisions within the shaded area between the arrows in the illustration to the right.

The front airbags and driver's knee airbag will deploy if the impact to the vehicle's main structure is above a specific threshold level. The threshold level is approximately 15 mph (25 km/h) for a frontal collision straight into a solid flat wall that does not bend or deform. If the impact to the vehicle's main structure is below this threshold level, the front airbags and driver's knee airbag may not deploy. This threshold level may also be higher if the vehicle hits something that absorbs the impact, either by bending or moving (for example,

another stationary vehicle, a pole or a guard rail).

The beginning stage of airbag inflation is the most forceful, and can cause serious injuries or death if you are too close to the deploying airbag. Accordingly, it is important that you always wear the available seat belt.

Supplemental Restraint System (SRS) - airbag

The front airbags and driver's knee airbag MAY NOT DEPLOY when ...

4

In certain types of front collisions, the front airbags and driver's knee airbag may not deploy, even if the deformation of the body seems to be large, because the vehicle's body structure is designed to absorb the impact and deform in order to help protect the occupants. Some typical situations where the front airbags and driver's knee airbag may not deploy are shown in the illustrations.

Because the front airbags and driver's knee airbag do not protect the occupant in all types of frontal collisions, be sure to always wear your seat belts properly.

Collision with a utility pole, tree or other narrow objects



Collision where the vehicle slides under the rear body of a truck



Oblique frontal impact

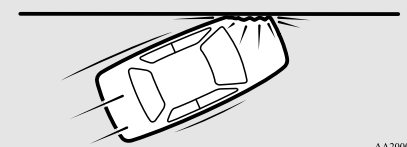

The front airbags and driver's knee airbag ARE NOT DESIGNED TO DEPLOY when ...

The front airbags and driver's knee airbag are not designed to deploy in situations where they cannot provide protection to the occupants. Some typical situations are shown in the illustrations.

Because the front airbags and driver's knee airbag do not protect the occupants in all types of collisions, be sure to always wear your seat belts properly.

Supplemental Restraint System (SRS) - airbag

Rear end collision to your vehicle



Side collision to your vehicle

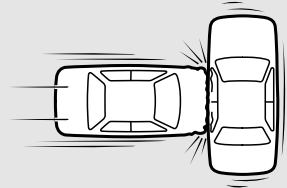

Vehicle rolls onto its side or roof

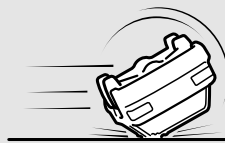

AA2000262

carriage impact). Some typical situations are shown in the illustrations.

Because the front airbags and driver's knee airbag may deploy in certain types of unexpected impacts, as shown in the illustrations, and these unexpected impacts can move you out of position, it is important to always wear your seat belts properly. When worn properly, seat belts can help maintain your distance from the airbags and driver's knee airbag when they begin to inflate. The beginning stage of airbag inflation is the most forceful and can cause serious injury or death if you are close to the deploying airbag.

Collision with an elevated median/island or curb



Vehicle travels over a deep hole/pothole

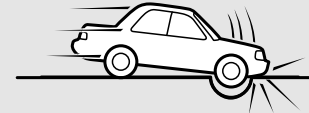

Vehicle drives down a steep slope and hits the ground

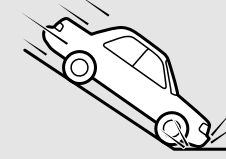

AA2000275

4

The front airbags and driver's knee airbag **MAY DEPLOY** when

...

The front airbags and driver's knee airbag may deploy if the underside of the vehicle suffers a moderate to severe impact (under-

Supplemental Restraint System (SRS) - airbag

4

⚠ WARNING

- Do not attach anything to the steering wheel's padded cover, such as trim material, badges, etc. These could strike and injure an occupant if the airbag inflates.
- Do not set anything on, or attach anything to, the instrument panel above the glove compartment. Such items could strike and injure an occupant if the airbag inflates.

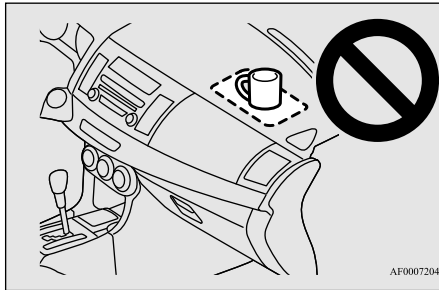

⚠ WARNING

- Do not attach accessories to, or put them in front of, the windshield. They could restrict the airbag inflation, or strike and injure an occupant, when the airbag inflates.

⚠ WARNING

- Do not attach additional keys or accessories (hard, pointed or heavy objects) to the ignition key. Such objects could prevent the driver's knee airbag from inflating normally or could be propelled to cause serious injury if the airbag inflates.
- Do not attach accessories to the lower portion of the driver's side instrument panel. Such objects could prevent the driver's knee airbag from inflating normally or could be propelled to cause serious injury if the airbag inflates.

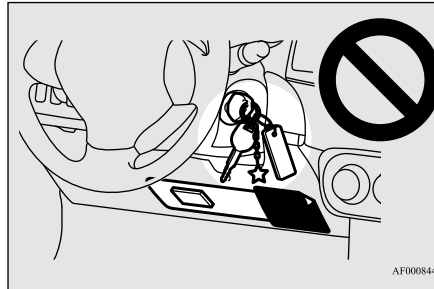

⚠ WARNING

- Do not attempt to remove, install, disassemble or repair the SRS airbags.

⚠ WARNING

- Do not place objects, such as packages or pets, between the airbags and the driver or the front passenger. Such objects can adversely affect airbag performance, or cause serious injury or death when the airbag deploys.
- Immediately after airbag inflation, some parts of the airbag system will be hot. Do not touch them. You could be burned.
- The airbag system is designed to work only once. After the airbags deploy, they will not work again. They must promptly be replaced and the entire airbag system must be inspected by an authorized Mitsubishi Motors dealer.

Supplemental Restraint System (SRS) - airbag

Side airbag system (if so equipped)

N00408100405

The side airbags (A) are contained in the driver and front passenger seatbacks. The side airbag is designed to inflate only on the side of the vehicle that is impacted, even with no passenger in the front seat.

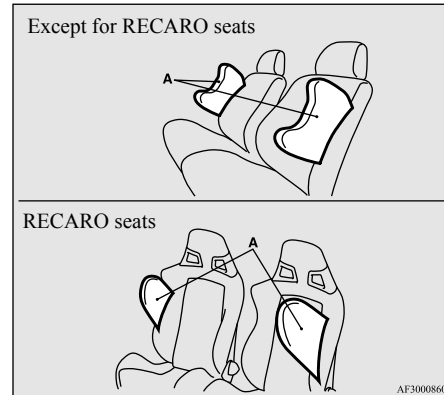

A label is attached to the seatbacks in vehicles with side airbags.

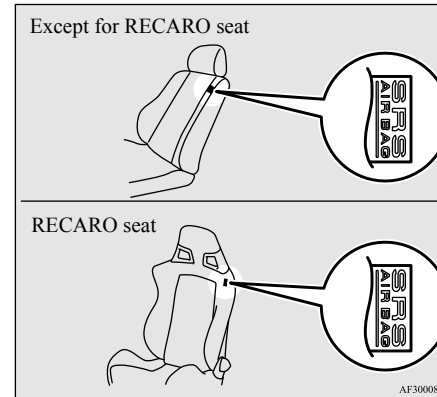

Curtain airbag system (if so equipped)

N00419201230

The curtain airbags are contained in the front and rear pillars and roof side rail. The curtain airbag is designed to inflate only on the side of the vehicle that is impacted, even with no passenger in the front seat.

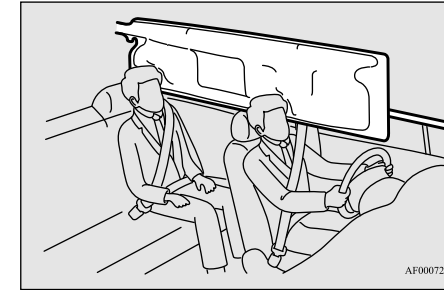

4

WARNING

- The side airbag and curtain airbag can cause serious injury or death to anyone too close to the airbag when it deploys. To reduce the risk of injury from a deploying side airbag and curtain airbags, all occupants must be properly restrained and seated well back, upright, and in the middle of the seat. Do not lean against the door.



Supplemental Restraint System (SRS) - airbag

4

⚠ WARNING

- In order to reduce the risk of injury from a deploying side airbag, do not allow any rear seat passengers to hold onto the back of either front seat. Special care should be taken with children.
- Do not place any objects near or around the front of either front seatback. Such objects can interfere with proper side airbag deployment and cause injury during deployment of the side airbag.
- Do not place stickers, labels or additional trim on the back of either front seat. They can interfere with proper side airbag deployment.
- Do not install seat covers or re-cover seats that have side airbags. Covers can interfere with proper side airbag deployment and adversely affect side airbag performance.
- Do not attach a microphone (A) or any other object around the part where the curtain airbag (B) deploys, such as on the windshield, side door glass or front and rear pillars and roof side rail. When the curtain airbag inflates, the microphone or other object may be hurled with great force or the curtain airbag may not inflate correctly, resulting in death or serious injury.

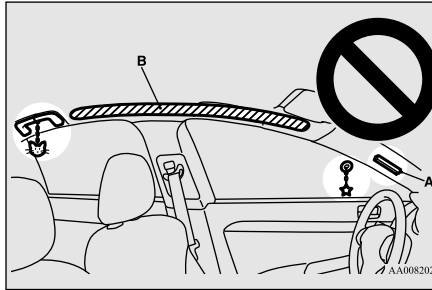
**⚠ WARNING**

- Do not put a hanger or any heavy or pointed object on the coat hook. If the curtain airbag was activated, any such item could be propelled away with great force and could prevent the curtain airbag from inflating correctly. Hang clothes directly on the coat hook (without using a hanger). Make sure there are no heavy or sharp objects in the pockets of clothes that you hang on the coat hook.
- Never install a rear-facing child restraint system in the front passenger seat. Rear-facing child restraint systems **MUST ONLY** be used in the rear seat.

⚠ WARNING

- Front-facing child restraint systems should also be used **ONLY** in the rear seat. If a front-facing child restraint system must be used in the front passenger seat, move the seat as far back as possible, and make sure that the child stays in the child restraint system, properly restrained and away from the door.
- Do not allow a child to lean against or sit close to the passenger door, even if the child is seated in a child restraint system. The child's head should also not lean against or be close to the section of the seatback where the side airbag and curtain airbag are located. It is dangerous if the side airbag and curtain airbag deploys. Failure to follow all of these instructions could lead to serious injury or death to the child.
- Work done on or in the vicinity of the side airbag and curtain airbag system components should be done only by an authorized Mitsubishi Motors dealer. Improper work methods can cause accidental side airbag and curtain airbag deployment, or render a side airbag and curtain airbag inoperable. Either of these situations can result in serious injury or death.

Supplemental Restraint System (SRS) - airbag

Deployment of side airbag and curtain airbag

N00408200507

The side airbag and curtain airbag ARE DESIGNED TO DEPLOY when ...

A side airbag and curtain airbag are designed to deploy when the vehicle suffers a moderate to severe side impact to the middle of the passenger compartment.

The typical situation is shown in the illustration.

Moderate to severe impact to the middle of the vehicle body's side structure

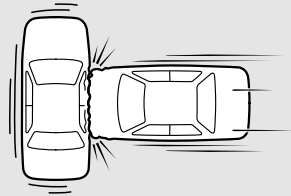

AA0037598

The seat belts in your vehicle are your primary means of protection in an accident. The SRS (Supplemental Restraint System) side airbags and curtain airbags are designed to provide additional protection. Therefore, for

your safety and the safety of all occupants, be sure to always wear your seat belts properly.

The side airbag and curtain airbag MAY NOT DEPLOY when ...

In certain types of side collisions, the side airbag and curtain airbag may not deploy, even if the deformation of the body seems to be large, because the vehicle's body structure is designed to absorb the impact and to deform in order to help protect the occupants. Some typical situations where the side airbag and curtain airbag may not deploy are shown in the illustrations.

Because the side airbags and curtain airbags do not protect the occupant in all types of side collisions, be sure to always wear your seat belts properly.

Side impact in an area away from the passenger compartment

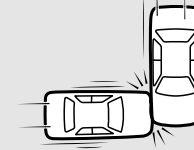

Motorcycle or other similar small vehicle collision with the side of vehicle



Collision with a utility pole, tree or other narrow object



AA2000448

4

Supplemental Restraint System (SRS) - airbag

4

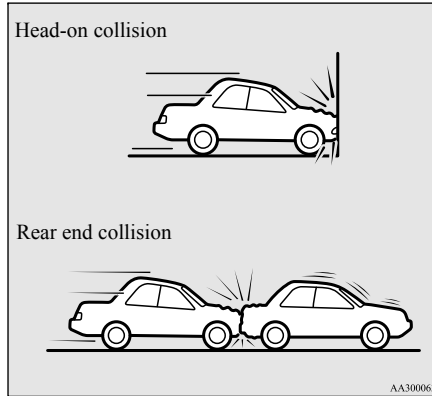
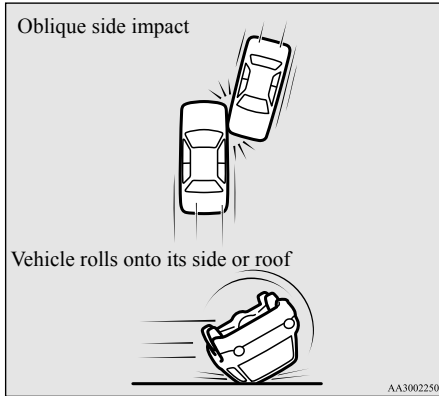

The side airbag and curtain airbag ARE NOT DESIGNED TO DEPLOY when ...

The side airbag and curtain airbag are not designed to deploy in situations where they cannot provide protection to the occupants. Typical situations where the side airbags and curtain airbags cannot provide protection are shown in the illustrations below.

Because the side airbags and curtain airbags do not protect the occupants in all types of collisions, be sure to always wear your seat belts properly.

4-36 Seat and restraint systems

SRS servicing

N00408500672

⚠ WARNING

- Any maintenance performed on or near the components of the SRS should be performed only by an authorized Mitsubishi Motors dealer. Do not permit anyone else to do any service, inspection, maintenance or repair on any SRS components or wiring. Similarly, no part of the SRS should ever be handled, removed or disposed by anyone except an authorized Mitsubishi Motors dealer.
Improper work methods on the SRS components or wiring could result in an accidental airbag deployment or could make the SRS inoperable. Either of these situations could result in serious injury or death.
- Do not modify your steering wheel or any other SRS component or related vehicle part. For example, replacement of the steering wheel, or modifications to the front bumper or body structure can adversely affect SRS performance and may lead to injury.
- If your vehicle has received any damage, you should have the SRS inspected by an authorized Mitsubishi Motors dealer to make sure it is in proper working order.

Supplemental Restraint System (SRS) - airbag

WARNING

- **Do not modify your front seats, center pillar or center console. Such modifications can adversely affect SRS performance and may lead to injury.**
Also, if you discover any tear or open seam in the seat fabric near the side airbag, have the seat inspected by an authorized Mitsubishi Motors dealer.
- **If you find a crack in or damage to the front pillar, rear pillar, or roof side rail where the curtain airbag is located, have the SRS inspected by an authorized Mitsubishi Motors dealer.**

NOTE

- When you transfer ownership of the vehicle to another person, we urge you to alert the new owner that it is equipped with the SRS and refer that owner to the applicable sections in this owner's manual.
- If you decide to junk or scrap your vehicle, we urge you to first take it to an authorized Mitsubishi Motors dealer so that the SRS can be made safe for disposal.
- If any of the following parts needs to be modified for use by a handicapped person, the advanced airbag system will be greatly affected. Please consult an authorized Mitsubishi Motors dealer for assistance.
 - Driver's seat
 - Front passenger seat
 - Front seat belt

NOTE

- Steering wheel
- Instrument panel

[For vehicles sold in U.S.A.]

To contact Mitsubishi Motors North America, Inc.
call 1-888-648-7820 or write to:
Mitsubishi Motors North America, Inc.
Customer Relations Department
P. O. Box 6400
Cypress, CA 90630-0064

[For vehicles sold in Canada]

To contact Mitsubishi Motor Sales of Canada, Inc.
call 1-888-576-4878 or write to:
Mitsubishi Motor Sales of Canada, Inc.
Customer Relations Department
P.O. Box 41009
4141 Dixie Road
Mississauga, ON L4W 5C9

[For vehicles sold in Puerto Rico]

To contact Mitsubishi Motor Sales of Caribbean, Inc.
call 1-787-251-8715 or write to:
Mitsubishi Motor Sales of Caribbean, Inc.
Customer Service Department
P.O. Box 192216
SAN JUAN PR 00919-2216

[For vehicles sold in Guam]

To contact Triple J Enterprises Inc.
call (671) 649-3673 or write to:
Triple J Enterprises, Inc.
P.O. Box 6066
TAMUNING
GUAM 96931

[For vehicles sold in Saipan]

To contact Triple J Motors
call (670) 234-7133 or write to:
Triple J Motors
P.O. Box 500487
SAIPAN, MP96950-0487



Supplemental Restraint System (SRS) - airbag

4

[For vehicles sold in American Samoa]

To contact Pacific Marketing Inc.
call 684 (699) 9140 or write to:

Pacific Marketing, Inc.

P.O. Box 698

PAGO PAGO,

AMERICAN SAMOA AS, 96799

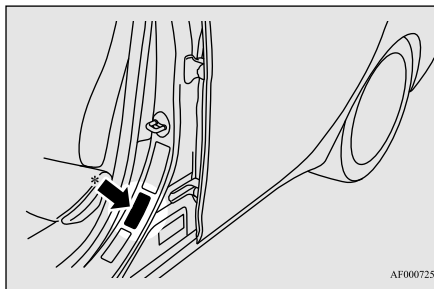

*- Located in the passenger's side as well.

Warning labels

N00408600341

Occupant restraint warning labels for the SRS are located in the vehicle as shown in the illustration.

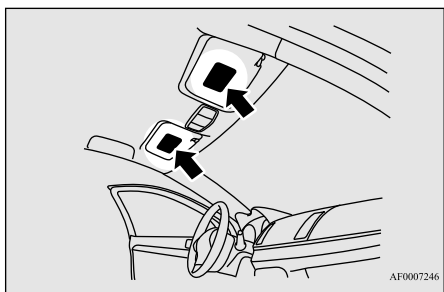

AF0007246

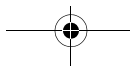

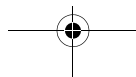
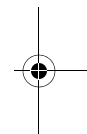
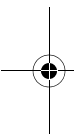
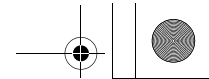

Horizontal dashed lines for text layout.

Features and controls

Break-in recommendations	5-3	All-wheel driving operation	5-86
Keys	5-3	Cautions on handling of all-wheel drive vehicles	5-87
Electronic immobilizer (Anti-theft starting system)	5-4	Limited-slip differential (if so equipped)	5-88
Keyless entry system (if so equipped)	5-7	Service brake	5-89
Free-hand Advanced Security Transmitter (F.A.S.T.-key) (if so equipped)	5-12	Brake assist system	5-90
Door locks	5-35	Hill start assist (vehicles with Twin Clutch SST)	5-90
Power door locks	5-37	Anti-lock braking system	5-91
“Child safety locks” for rear door	5-39	Active Stability Control (ASC) (if so equipped)	5-94
Trunk lid	5-39	Power steering system	5-96
Inside emergency trunk lid release	5-41	Cruise control (if so equipped)	5-97
Theft-alarm system	5-42	Tire pressure monitoring system	5-102
Power windows	5-44	Rear-view camera (if so equipped)	5-106
Sunroof (if so equipped)	5-46	Instrument cluster	5-108
Parking brake	5-48	Multi-information display	5-110
Steering wheel tilt lock lever	5-50	Indicator light, warning light, and information screen display list	5-131
Inside day/night rearview mirror	5-50	Indicators	5-143
Outside rearview mirrors	5-52	Warning lights	5-144
Ignition switch	5-53	Information screen display	5-145
Steering wheel lock	5-55	Combination headlights and dimmer switch	5-147
Starting and stopping the engine	5-55	Headlight leveling switch (if so equipped)	5-152
Turbocharger operation (if so equipped)	5-59	Turn signal lever	5-152
Manual transaxle (if so equipped)	5-59	Hazard warning flasher switch	5-153
Continuously variable transmission (CVT) (if so equipped)	5-61	Front fog light switch (if so equipped)	5-153
Twin Clutch SST (Sportronic Shift Transmission) (if so equipped)	5-70	Wiper and washer switch	5-154
ACD (Active center differential system) (if so equipped)	5-82	Electric rear window defogger switch	5-158
Electronically controlled 4WD system (if so equipped)	5-84	Horn switch	5-159
		Link System (if so equipped)	5-159

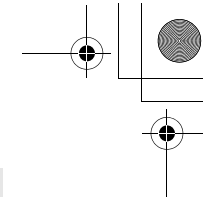
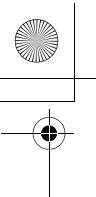

Features and controls

5

Bluetooth® 2.0 interface (if so equipped)	5-159
USB input terminal (if so equipped)	5-181
Sun visors	5-184
12 V power outlet	5-184
Interior lights	5-185
Storage spaces	5-187
Cup holder	5-190
Bottle holder	5-191
Assist grip	5-191
Coat hook (if so equipped)	5-192

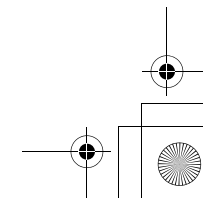
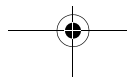
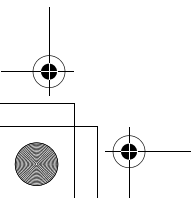
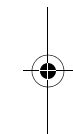
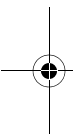

Break-in recommendations

N00508700297

Advanced automobile manufacturing techniques permit you to operate your new vehicle without requiring a long break-in period of low-speed driving.

However, you can add to the future performance and economy of your vehicle by observing the following precautions during the first 300 miles (500 km).

Drive your vehicle at moderate speeds during the break-in period.

- Avoid revving the engine. For vehicles with turbocharger, do not exceed 5,000 rpm for the first 600 miles (1,000 km).
- Avoid rough driving such as fast starts, sudden acceleration, prolonged high-speed driving and sudden braking. These would have a detrimental effect on the engine and also cause increased fuel and oil consumption, which could result in malfunction of the engine components. Be particularly careful to avoid full acceleration while in low gear.
- Do not overload the vehicle. Observe the seating capacity (See “Cargo load precautions” on page 6-10).
- Do not use this vehicle for trailer towing.

Keys

N00508800559

Type 1

Two keys are provided. The keys fit all locks. Keep one in a safe place as a spare key.

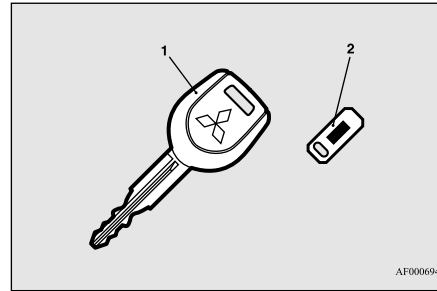

- 1- Key for the electronic immobilizer
- 2- Key number plate

Type 2

Two keys are provided. The keys fit all locks. Keep one in a safe place as a spare key.

Break-in recommendations

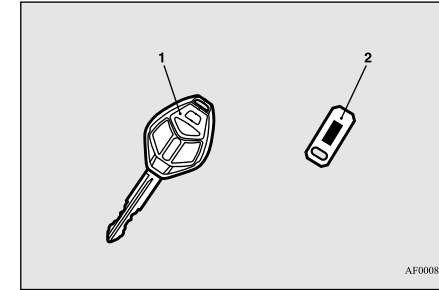

- 1- Key for the electronic immobilizer and keyless entry system
- 2- Key number plate

Type 3

Two Free-hand Advanced Security Transmitter (F.A.S.T.-key) and two emergency keys are provided.

Keep one F.A.S.T.-key and one emergency key in a safe place together as a set of spare keys.

5

Electronic immobilizer (Anti-theft starting system)

5

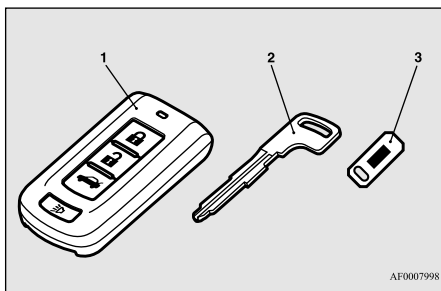

- 1- Free-hand Advanced Security Transmitter (F.A.S.T.-key)
(with electronic immobilizer and keyless entry system function)
- 2- Emergency key
- 3- Key number plate

NOTE

- The key is a precision electronic device with a built-in signal transmitter. Please observe the following in order to prevent damage.
 - Do not leave where it may be exposed to heat caused by direct sunlight, such as on top of the dashboard.
 - Do not take the remote control transmitter apart.
 - Do not excessively bend the key or subject it to strong impacts.
 - Keep the remote control transmitter dry.
 - Keep away from magnetic objects such as key holders.

NOTE

- Keep away from devices that produce magnetism, such as audio systems, computers and televisions.
- Keep away from devices that emit strong electromagnetic waves, such as cellular phones, wireless devices and high frequency equipment (including medical devices).
- Do not clean with ultrasonic cleaners.
- Do not leave the key where it may be exposed to high temperature or high humidity.
- If you lose your key, to prevent the theft of the vehicle immediately contact an authorized Mitsubishi Motors dealer. If you notify an authorized Mitsubishi Motors dealer of the key number, they can make a new key. The key number is stamped on the key number plate. Keep the key number plate in a safe place separate from the key itself.
- No keys other than those registered in advance can be used to start the engine. Refer to “Electronic immobilizer (Anti-theft starting system)” on page 5-4. Refer to “Free-hand Advanced Security Transmitter (F.A.S.T.-key)”: “Electronic immobilizer (Anti-theft starting system)” on page 5-28.

Electronic immobilizer (Anti-theft starting system)

N00509101804

[For vehicles equipped with the Free-hand Advanced Security Transmitter (F.A.S.T.-key)]
For information on operations for vehicles equipped with the Free-hand Advanced Security Transmitter (F.A.S.T.-key), refer to “Free-hand Advanced Security Transmitter (F.A.S.T.-key)”: “Electronic immobilizer (Anti-theft starting system)” on page 5-28.

[Except for vehicles equipped with the Free-hand Advanced Security Transmitter (F.A.S.T.-key)]
The electronic immobilizer is designed to significantly reduce the possibility of vehicle theft. The purpose of the system is to immobilize the vehicle if an invalid start is attempted. A valid start attempt can only be achieved (subject to certain conditions) using a key “registered” to the immobilizer system. All of the keys provided with your new vehicle have been programmed to the vehicle’s electronics.

Electronic immobilizer (Anti-theft starting system)

NOTE

- Do not attach additional keys or accessories to the ignition key. Such objects could prevent the driver's knee airbag from inflating normally. Refer to "Deployment of front airbags" on page 4-29.
- In the following cases, the vehicle may not be able to recognize the registered ID code from the key. This means the engine will not start even when the key is turned to the "START" position.
 - When the key contacts a key ring or other metallic or magnetic object (Type A)
 - When the key grip contacts metal of another key (Type B)
 - When the key contacts or is close to other immobilizer keys (including keys of other vehicles) (Type C)
- In cases like the above, move the offending object(s) away from the key and turn the key back to the "ACC" or "LOCK" position. Then try to start the engine again. If the engine does not start, contact an authorized Mitsubishi Motors dealer.



NOTE

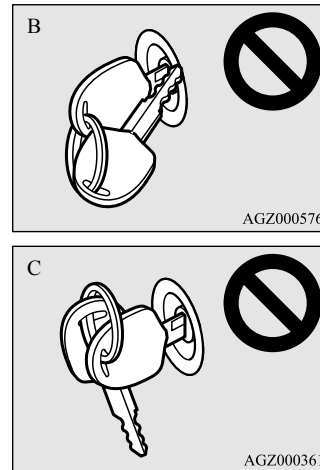

- The key may not operate properly when it is near an object or facility that emits strong electromagnetic waves.
- Electronic immobilizer is not compatible with commercially available remote starting systems. Use of commercially available remote starting systems may result in vehicle starting problems and a loss of security protection.
- A system failure is suspected when the ignition switch is turned to the "START" position, and the engine does not start. In such a case, contact an authorized Mitsubishi Motors dealer.

WARNING

- Do not make any alterations or additions to the immobilizer system. Alterations or additions could cause failure of the immobilizer.

Replacement keys

5

Only keys that have been programmed to the vehicle's electronics can be used to start the vehicle.

If you lose the key, you can order a key from your authorized Mitsubishi Motors dealer by referring to the key number.

To prevent vehicle theft, the ID code for the vehicle keys must be changed.

Take your vehicle and all remaining keys to your authorized Mitsubishi Motors dealer to have your ID code changed.

Additional keys

To add a key, you need to register the ID code to the vehicle.

Registering the ID code can be done by your authorized Mitsubishi Motors dealer. Or it can be done by yourself (except for vehicles sold in Canada).

Electronic immobilizer (Anti-theft starting system)

For you to register the ID code yourself, follow the “Customer key programming” procedure below.

If you choose to have your authorized Mitsubishi Motors dealer register the ID code, take your vehicle and all remaining keys to your authorized Mitsubishi Motors dealer.

5

NOTE

- You are provided with two keys, but you may register up to eight keys.

Customer key programming (Except for vehicles sold in Canada)

N00562201136

You can program new keys to the system if you have two valid (already registered) keys and blank (not registered) immobilizer key (specially cut for your vehicle at your Mitsubishi Motors dealer) by doing the following:

1. Insert the first valid key into the ignition switch and turn the key to the “ON” position for 5 seconds.
2. Turn the key to the “LOCK” position and remove the first key.

3. Within 30 seconds of turning the first key to the “LOCK” position, insert the second valid key into the ignition and turn it to the “ON” position. About 10 seconds later, the immobilizer display will start to blink.
4. When the immobilizer display starts blinking, turn the second valid key to the “LOCK” position and remove it. Within 30 seconds after doing so, insert a blank immobilizer key into the ignition switch and turn it to the “ON” position. Perform this operation no more than 30 seconds after the immobilizer display starts blinking. When registration of the ID code is complete, the immobilizer display will come on for 3 seconds then go off. If an error occurs, the immobilizer display will go off during the procedure.



5. If you wish to register another key, perform the process again from step 1.

NOTE

- Perform the operation when the interrupt display screen is not showing. The interrupt display screen may prevent you from seeing the immobilizer display.

NOTE

- It is not possible to register a key if:
 - the immobilizer display goes off during the procedure
 - the immobilizer display does not come on within 30 seconds after turning the ignition switch to the “ON” position with a blank immobilizer key
- The procedure will be terminated automatically if:
 - a period of 30 seconds or longer elapses from the moment when the first key is turned to the “LOCK” position to the moment when the second key is turned to the “ON” position
 - a period of 30 seconds or longer elapses from the moment when the second key is turned to the “LOCK” position to the moment when the blank immobilizer key is turned to the “ON” position
- To use the new remote control transmitters, it is necessary to register the key with both the electronic immobilizer and keyless entry system. Also refer to “Keyless entry system: Customer remote control transmitter programming” on page 5-9.

General information

Your electronic immobilizer operates on a radio frequency subject to Federal Communications Commission (FCC) Rules (For vehi-

cles sold in U.S.A.) and Industry Canada Rules (For vehicles sold in Canada). This device complies with Part 15 of FCC Rules and Industry Canada licence-exempt RSS standard(s).

Operation is subject to the following two conditions.

- This device may not cause harmful interference.
- This device must accept any interference received, including interference that may cause undesired operation.

CAUTION

- Changes or modifications not expressly approved by the manufacturer for compliance could void the user's authority to operate the equipment.

Keyless entry system (if so equipped)

N00509000763

Press the remote control transmitter buttons to lock or unlock the doors and to open the trunk lid.

It can also help you signal for attention by setting off the panic alarm.

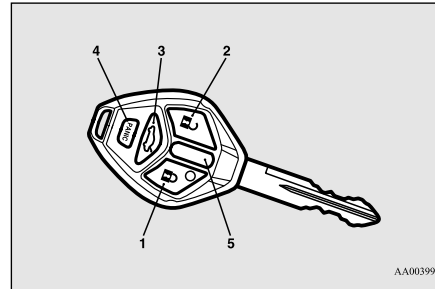

AA0039983

- 1- LOCK (🔒) button
- 2- UNLOCK (🔓) button
- 3- Trunk (↔️) button
- 4- PANIC button
- 5- Indicator light

To lock the doors

N00542700024

Press the LOCK button (1) to lock all the doors.

The turn signal lights will also blink once.

NOTE

- If you press the LOCK button (1) twice quickly, the horn will sound once.

Keyless entry system (if so equipped)

To unlock the doors

N00543301095

Press the UNLOCK button (2) to unlock the driver's door only.

Within about 2 seconds, press the UNLOCK button one more time to unlock all the doors.

The dome light will turn on for 30 seconds. The turn signal lights will also blink twice.

Except for vehicles with the rear seat arm rest, the front side-marker and parking lights will also turn on for about 30 seconds.

Refer to "Welcome light" on page 5-151.

5

NOTE

- The door unlock function can be set so that all doors unlock when the UNLOCK button (2) is pressed once. Refer to "Setting of door unlock function" on page 5-9.

To open the trunk lid

N00543400015

Press the trunk button (3) twice within about 5 seconds and the trunk lid will be opened.

The trunk lid must be closed manually after it has been opened.

Keyless entry system (if so equipped)

Answerback function

N00543501084

Setting of the horn, turn signal lights and buzzer of the keyless entry system answerback function can be changed as required. This is done with the key removed from the ignition switch.

5

NOTE

- The answerback function does not operate when the key is in the ignition switch or any doors is opened.

Horn deactivation/reactivation

The horn answerback function can be set to the following three conditions. Each time the horn answerback function is set, a chime will sound to tell you the condition of the answerback function.

Number of chimes	Condition
One chime	The horn will not sound.
Two chimes	The horn will sound.

Number of chimes	Condition	
	To lock	To unlock
Four chimes	The horn will sound if the LOCK button is pressed twice quickly.	

1. Remove the key from the ignition switch.
2. Open the driver's door and turn the combination headlights and dimmer switch to the "OFF" position.
3. Press the LOCK button (1) for 4 to 10 seconds and press the UNLOCK button (2) during this time.
4. Release in sequence the UNLOCK and LOCK buttons within 10 seconds of pressing the UNLOCK button in step 3.

Changing the setting of the turn signal lights answerback function

The turn signal lights answerback function can be set to the following seven conditions. Each time the turn signal lights answerback function is set, a chime will sound to tell you the condition of the answerback function.

Number of chimes	Condition	
	To lock	To unlock
One chime	One flash	Two flashes

Number of chimes	Condition	
	To lock	To unlock
Two chimes	One flash	No flash
Three chimes	No flash	Two flashes
Four chimes	Two flashes	One flash
Five chimes	No flash	One flash
Six chimes	Two flashes	No flash
Seven chimes	No flash	No flash

1. Remove the key from the ignition switch.
2. Open the driver's door and turn the combination headlights and dimmer switch to the "OFF" position.
3. Press the UNLOCK button (2) for 4 to 10 seconds and press the LOCK button (1) during this time.
4. Release in sequence the UNLOCK and LOCK buttons within 10 seconds of pressing the LOCK button in step 3.

Buzzer deactivation/reactivation

The buzzer answerback function can be turned ON or OFF as required.

Setting of door unlock function

N00543601131

The door unlock function can be set to the following two conditions.

Each time the door unlock function is set, a chime will sound to tell you the condition of the door unlock function.

Number of chimes	Condition
One chime	All doors unlock
Two chimes	Driver's door unlock only

1. Remove the key from the ignition switch.
2. Open the driver's door and turn the combination headlights and dimmer switch to the "OFF" position.
3. Press the LOCK button (1) for 4 to 10 seconds and press the UNLOCK button (2) during this time.
4. Release in sequence the LOCK and UNLOCK buttons within 10 seconds of pressing the LOCK button in step 3.

Using the panic alarm

N00543700018

If you are near your vehicle and feel threatened, you may activate the alarm to call attention as follows:

1. Press the PANIC button (4) for more than 1 second.
2. The headlights will blink on and off and the horn will sound intermittently for about 3 minutes.
3. To turn off the alarm, press any button on the remote control transmitter.

Replacement remote control transmitters

N00543800019

Only remote control transmitters programmed with the vehicle's electronics can lock or unlock all doors.

If you lose the remote control transmitter, you can order a remote control transmitter from your authorized Mitsubishi Motors dealer by referring to the key number.

To prevent vehicle theft, the ID codes for all the remote control transmitters except the one for the lost key must be programmed again.

Take your vehicle and all the remaining remote control transmitters to your authorized Mitsubishi Motors dealer to have your ID codes programmed again.

Keyless entry system (if so equipped)

Additional remote control transmitters

N00543900010

To add a remote control transmitter, you must already have one registered remote control transmitter.

Registering the ID code can be done by yourself or by your authorized Mitsubishi Motors dealer. For you to register the ID code yourself, follow the "Customer remote control transmitter programming" procedure below.

If you choose to have your authorized Mitsubishi Motors dealer register the ID code, take your vehicle and all remaining keys to your authorized Mitsubishi Motors dealer.

5

NOTE

- You are provided with two remote control transmitters, but you may register up to eight remote control transmitters.

Customer remote control transmitter programming

N00544001129

You can program new remote control transmitters to the system if you have one valid (already registered) remote control transmitter by doing the following:

Keyless entry system (if so equipped)

5

1. Have available all (current and new) remote control transmitters you wish to register.
2. With a valid (already registered) remote control transmitter, press the UNLOCK button (2) for 4 to 10 seconds. Then press and hold the LOCK button (1).
3. Within 10 seconds of pressing the LOCK button, release the LOCK and UNLOCK buttons in sequence.
At this time, ID codes for all remote control transmitters except for the transmitter used in steps 2 and 3 are erased and the answerback function (door is locked and unlocked) informs you that the registration mode has been activated.
4. Within 60 seconds after step 3, complete the following ID code registration operation using the next remote control transmitter you wish to register within 4 seconds.
 - i. Press both the LOCK and UNLOCK buttons for 2 seconds.
 - ii. Release both the LOCK and UNLOCK buttons for 1 second.
 - iii. Press the UNLOCK button.
The answerback function informs you that the ID code registration of the transmitter is completed.
5. To register the ID codes of additional remote control transmitters, repeat step 4 within 60 seconds after step 4.

6. If no ID code of a remote control transmitter is registered within 60 seconds after step 4, the registration mode is canceled and the normal mode returns.

NOTE

- For verification purposes, try to lock and unlock the doors after the registration is completed.
- The indicator light (5) comes on each time a button is pressed.
- The keyless entry system does not work if the key is in the ignition switch.
- The remote control transmitter can be used from about 40 feet (12 m) away. However, this distance may change if your vehicle is near a TV transmitting tower, a power station, or a radio station.
- If the UNLOCK button (2) is pressed when all doors are locked and no doors are opened within about 30 seconds, the doors will automatically re-lock.
- If the following conditions are observed after pressing the buttons on the remote control transmitter, the battery in the remote control transmitter may need to be replaced.
 - The doors cannot be locked or unlocked.
 - The trunk lid cannot be opened.
 - The panic alarm cannot be operated.
 - The indicator light (5) is dim or does not come on.

NOTE

- If you lose your remote control transmitter, please contact an authorized Mitsubishi Motors dealer for a replacement.
- If you wish to obtain an additional remote control transmitter, please contact an authorized Mitsubishi Motors dealer. A maximum of eight remote control transmitters can be programmed for your vehicle.
- To use the new remote control transmitters, it is necessary to register the key with both the electronic immobilizer and keyless entry system.
Also refer to “Electronic immobilizer (Anti-theft starting system): Customer key programming” on page 5-6.

General information

N0054610111

Your keyless entry system operates on a radio frequency subject to Federal Communications Commission (FCC) Rules (For vehicles sold in U.S.A.) and Industry Canada Rules (For vehicles sold in Canada). This device complies with Part 15 of FCC Rules and Industry Canada licence-exempt RSS standard(s).

Operation is subject to the following two conditions.

- This device may not cause harmful interference.

- This device must accept any interference received, including interference that may cause undesired operation.

⚠ CAUTION

- Changes or modifications not expressly approved by the manufacturer for compliance could void the user's authority to operate the equipment.

Procedure for replacing the remote control transmitter battery

N00544100077

1. Before replacing the battery, remove static electricity from your body by touching a metal grounded object.
2. With the Mitsubishi mark facing you, insert the cloth-covered tip of a flat blade screwdriver into the notch in the remote control transmitter case and use it to open the case.

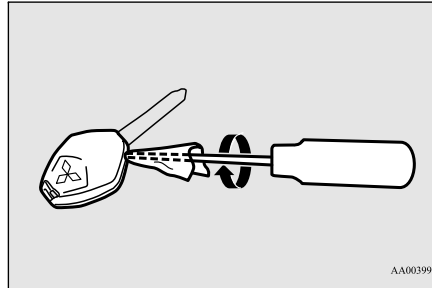

📖 NOTE

- Be sure to perform the procedure with the Mitsubishi mark facing you. If the Mitsubishi mark is not facing you when you open the remote control transmitter case, the buttons may come out.

3. Remove the remote control transmitter from the remote control transmitter case. Then, open the remote control transmitter using the method described in step 2.

Keyless entry system (if so equipped)

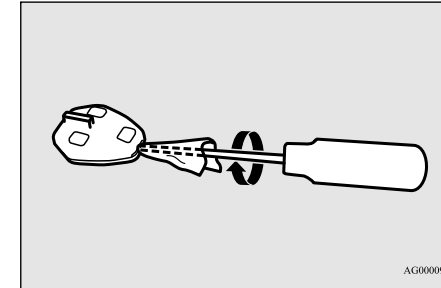

5

4. Remove the old battery.
5. Install a new battery with the +side (A) down.

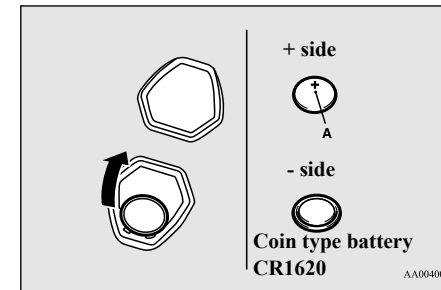

6. Close the remote control transmitter firmly.
7. Place the remote control transmitter in the remote control transmitter case, then securely close the remote control transmitter case.

Free-hand Advanced Security Transmitter (F.A.S.T.-key) (if so equipped)

8. Check the keyless entry system to see that it works.

NOTE

- You may purchase a replacement battery at an electric appliance store.
- Your authorized Mitsubishi Motors dealer can replace the battery for you if you prefer.

5

CAUTION

- When the remote control transmitter case is opened, be careful to keep water, dust, etc. out. Also, do not touch the internal components.

Free-hand Advanced Security Transmitter (F.A.S.T.-key) (if so equipped)

N00503100052

The Free-hand Advanced Security Transmitter (F.A.S.T.-key) enables the doors to be locked and unlocked, the trunk lid to be opened, and the engine to be started simply by carrying it.

The F.A.S.T.-key can also be used as the remote control transmitter of the keyless entry system.

Refer to “Free-hand Advanced Security Transmitter (F.A.S.T.-key)”: “Keyless entry

The F.A.S.T.-key must be carried by the driver. The F.A.S.T.-key is required for vehicle operations such as locking and unlocking the doors, opening the trunk lid, and starting the engine. When leaving the vehicle, make sure you are carrying the F.A.S.T.-key and then lock the vehicle.

WARNING

- Individuals who use implantable pacemakers or implantable cardioverter-defibrillators should keep away from the external and internal transmitters. The electromagnetic waves used in the F.A.S.T.-key may affect the operation of implantable pacemakers and implantable cardioverter-defibrillators.

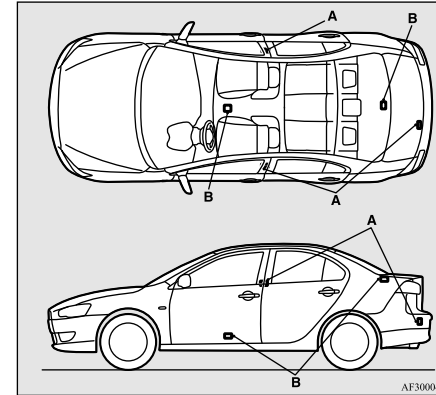

- A- External transmitter
B- Internal transmitter

WARNING

- Individuals using other electrical medical apparatuses besides implantable pacemakers and implantable cardioverter-defibrillators should check with the manufacturer of the apparatus to confirm the effect of the electromagnetic waves used by the F.A.S.T.-key. The electromagnetic waves may affect the operations of the electro-medical apparatus.

Free-hand Advanced Security Transmitter (F.A.S.T.-key) (if so equipped)

The operations possible with the F.A.S.T.-key can be modified as stated below. (Keyless entry operations are possible.) For details, contact an authorized Mitsubishi Motors dealer.

- Enabling only the locking and unlocking of the doors and the opening of the trunk lid
- Enabling only the starting of the engine
- Deactivating the F.A.S.T.-key

NOTE

- The F.A.S.T.-key uses weak electromagnetic waves. In cases such as the following, operation may be improper or unstable.
 - The vehicle is near a facility that emits strong electromagnetic waves, such as a TV transmitting tower, a power station, a radio station or an airport
 - The key is carried together with other communication devices such as cellular phones or radios, or electrical appliances such as computers
 - The F.A.S.T.-key touches or is covered by a metal object
 - A keyless entry system is being used nearby
 - The battery of the F.A.S.T.-key is run down
 - The vehicle is in a location with strong electromagnetic waves or noise

NOTE

Use the emergency key in such circumstances.

Refer to “To operate using the emergency key” on page 5-23.

- The F.A.S.T.-key is constantly performing reception operations in its communication with the vehicle. This means that the battery is always running down, regardless of how often the F.A.S.T.-key is used. The battery life is about 1 to 3 years, depending on the usage conditions.
- Since the F.A.S.T.-key is constantly performing reception operations, the reception of strong electromagnetic waves can accelerate the running down of the battery. Do not place near electrical appliances such as televisions or computers.

Operating range of the F.A.S.T.-key

N00503200112

When a person enters the operating range of the F.A.S.T.-key while carrying the F.A.S.T.-key and presses the driver's or front passenger's door lock/unlock switch or the trunk lid OPEN switch, verification of the ID code is performed.

The F.A.S.T.-key enables the doors to be locked and unlocked, the trunk lid to be opened and the engine to be started only

when the ID codes of the vehicle and F.A.S.T.-key match.

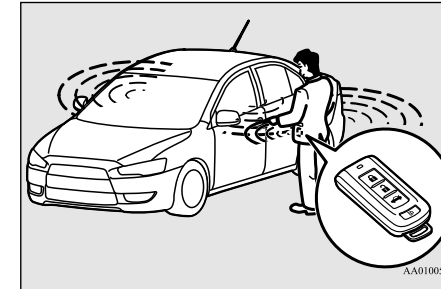

5

NOTE

- When the battery of the F.A.S.T.-key has run down or there are strong electromagnetic waves or noise in the area, the operating range could decrease or operations could become unstable.

Operating range for locking and unlocking the doors and for opening the trunk lid

The operating range is within about 2.3 feet (70 cm) of the driver's and front passenger's door lock/unlock switches, and the center of the trunk lid.

Free-hand Advanced Security Transmitter (F.A.S.T.-key) (if so equipped)

5

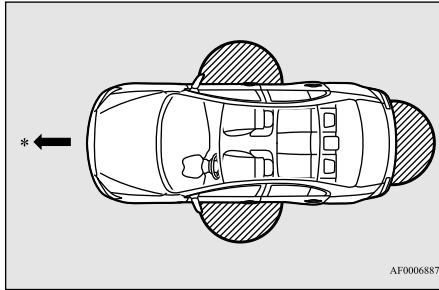

AF0006887

*: Front of the vehicle

: Operating range

NOTE

- Only the F.A.S.T.-key that is detectable by the doors and the trunk lid can lock and unlock the doors and open the trunk lid.
- The system may not operate if the F.A.S.T.-key is too close to the windshield, door windows or trunk lid.
- Even if the F.A.S.T.-key is within about 2.3 feet (70 cm) of the driver's or front passenger's door lock/unlock switch and center of the trunk lid, the system may not operate if the key is close to the ground or in a high position.
- If the F.A.S.T.-key is within the operating range, even a person not carrying the F.A.S.T.-key can lock and unlock the doors or open the trunk lid by pressing the driver's or front passenger's door lock/unlock switch or the trunk lid OPEN switch.

Operating range for starting the engine

N00503300025

The operating range is the interior of the vehicle.

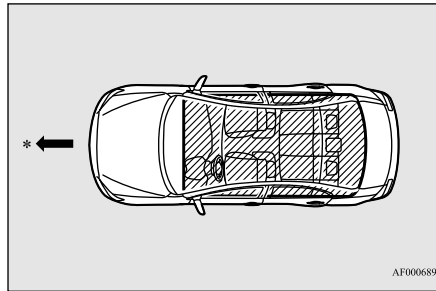

AF0006890

*: Front of the vehicle

: Operating range

NOTE

- Even if the F.A.S.T.-key is within the operating range, it may not be possible to start the engine if the key is in a storage space such as the glove compartment, on top of the instrument panel, or in the door pocket or trunk compartment.
- Even if the F.A.S.T.-key is outside the vehicle, it may be possible to start the engine if the key is too close to a door or door window.

To operate using the F.A.S.T.-key

N00503401241

To lock the doors

While carrying the F.A.S.T.-key, press the driver's or front passenger's door lock/unlock switch (A) within the operating range to lock all the doors.

The turn signal lights will blink once and the buzzer will sound once.

Also refer to "Door locks" and "Power door locks" on pages 5-35 and 5-37 respectively.

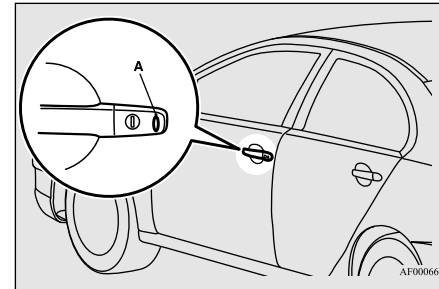

AF0006669

NOTE

- In cases such as the following, the F.A.S.T.-key does not operate.

Free-hand Advanced Security Transmitter (F.A.S.T.-key) (if so equipped)

NOTE

- There is a F.A.S.T.-key in the passenger compartment
- A door is open or ajar
- The ignition switch is in a position other than “LOCK”
- The emergency key is inserted into the ignition switch
- When the vehicle is locked, the theft-alarm system prepares to enter the armed stage. Refer to “Theft-alarm system” for further details on page 5-42.

To unlock the doors

While carrying the F.A.S.T.-key within the operating range, you can unlock the doors by F.A.S.T.-key operation.

The dome light will turn on for 30 seconds. The turn signal lights will blink twice and the buzzer will sound twice.

Also refer to “Door locks” and “Power door locks” on pages 5-35 and 5-37 respectively.

Press the driver’s door lock/unlock switch (A) to unlock only the driver’s door.

Within about 2 seconds, press the driver’s door lock/unlock switch (A) one more time to unlock all the doors.

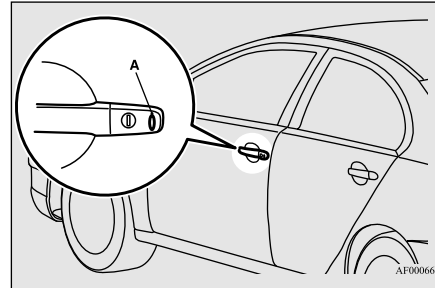

NOTE

- Settings can be changed so that all doors are unlocked automatically by one press of the driver’s door lock/unlock switch (A). Refer to “Setting of door unlock function” on pages 5-9 and 5-32.

Press the front passenger’s door lock/unlock switch (A) to unlock all the doors.

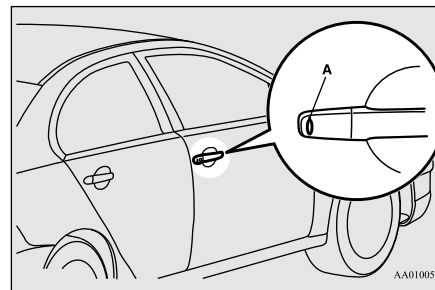

NOTE

- If the doors are unlocked when all doors are locked and no doors are opened within about 30 seconds, the doors will automatically re-lock.
- In cases such as the following, the F.A.S.T.-key does not operate.
 - A door is open or ajar
 - The ignition switch is in a position other than “LOCK”
 - The emergency key is inserted into the ignition switch
- The amount of time after unlocking until the vehicle re-locks automatically can be adjusted. See an authorized Mitsubishi Motors dealer for details.
- Function settings can be modified as stated below. See an authorized Mitsubishi Motors dealer for details.
 - Activating the operation confirmation function (blink of the turn signal lights) only during locking, or only during unlocking.
 - Deactivating the operation confirmation function (blink of the turn signal lights) and buzzer.
 - Modifying the number of blink in the operation confirmation function (blink of the turn signal lights).
 - Making the buzzer sound when the F.A.S.T.-key is removed from the passenger compartment when all the doors are closed.

Free-hand Advanced Security Transmitter (F.A.S.T.-key) (if so equipped)

To open the trunk lid

While carrying the F.A.S.T.-key within the operating range to open the trunk lid, press and hold down the OPEN switch (A) until the trunk lid opens.

5 Also refer to “Trunk lid” on pages 5-39 respectively.

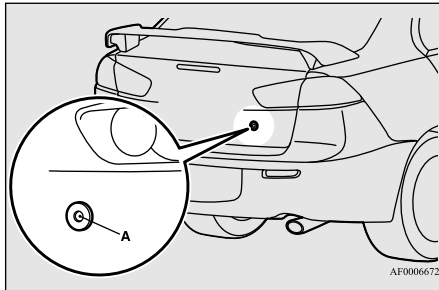

NOTE

- The F.A.S.T.-key does not operate when the trunk lid is open.

Ignition switch

N00513500059

To prevent vehicle theft, no F.A.S.T.-keys other than those registered in advance can be

used to start the engine. (Electronic immobilizer function)

While carrying the F.A.S.T.-key, the ignition switch can be turned to start the engine.

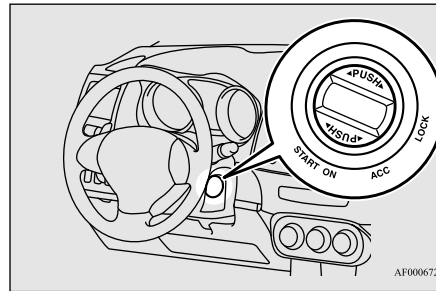

LOCK (PUSH OFF)

The position where the steering wheel is locked.

LOCK (PUSH ON)

When the ID code verification inside the vehicle produces a match, the ignition switch can be turned.

ACC

Allows operation of electrical accessories with the engine off.

ON

The engine runs and all electrical accessories can be used.

START

Engages the starter. Release the ignition switch when the engine starts. The ignition switch returns automatically to the “ON” position.

NOTE

- Your vehicle is equipped with an electronic immobilizer. To start the engine, the ID code which the F.A.S.T.-key sends must match the one registered to the immobilizer computer. (Refer to “Electronic immobilizer (Anti-theft starting system)” on page 5-28.)

Free-hand Advanced Security Transmitter (F.A.S.T.-key) (if so equipped)

NOTE

- If the ignition switch is not turned to the “LOCK (PUSH OFF)” position when the engine is not running, the ID code cannot be verified and the engine will not start even if the ignition switch is turned to the “START” position. If this happens, fully return the ignition switch to the “LOCK (PUSH OFF)” position, and start the engine again.

To turn from “LOCK (PUSH OFF)” to “ACC”

N00513600021

Turn slowly after pressing the ignition switch.

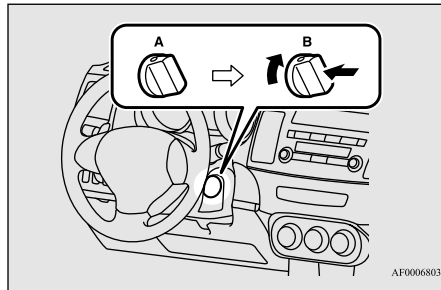

- A- Steering wheel locked
B- Steering wheel lock released

NOTE

- To turn the ignition switch from the “LOCK (PUSH OFF)” position to the “ACC” position, push the ignition switch again, turn the steering wheel in both directions and then turn the ignition switch.
- The ignition switch cannot be turned unless the F.A.S.T.-key is inside the vehicle. Refer to “Operating range for starting the engine” on page 5-14.

To turn from “ACC” to “LOCK”

N00513700051

For vehicles with manual transaxle

Slowly turn the ignition switch to the “LOCK” position while pressing it.

For vehicles with continuously variable transmission (CVT) or Twin Clutch SST (sportronic shift transmission)

First, set the selector lever (CVT) or the gearshift lever (Twin Clutch SST) to the “P” (PARK) position, and then slowly turn the ignition switch to the “LOCK” position while pressing it.

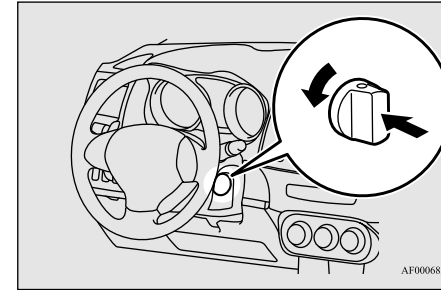

5

NOTE

- For vehicle with CVT or Twin Clutch SST, the ignition switch cannot be turned to the “LOCK” position unless the selector lever (CVT) or the gearshift lever (Twin Clutch SST) is in the “P” (PARK) position.

CAUTION

- If the engine is stopped while driving, the power brake booster will stop functioning and greater effort for braking will be required. Also, the power steering system will not function and it will require greater effort to manually steer the vehicle.
- Do not leave the ignition switch in the “ON” position for a long time when the engine is not running. Doing so could lead to a dead battery.
- Do not turn the ignition switch to the “START” position when the engine is running. It will damage the starter motor.

Free-hand Advanced Security Transmitter (F.A.S.T.-key) (if so equipped)



Warning activation

N00503500160

With the F.A.S.T.-key, warnings are given through buzzers and displays on the information screen in the multi-information display in order to prevent mistaken operations or vehicle theft.







5

When a warning operates, be sure to check the vehicle and the F.A.S.T.-key. A warning is also displayed if there is a problem in the F.A.S.T.-key. If the following warning displays, contact an authorized Mitsubishi Motors dealer.







Type 1 	There is a problem in the F.A.S.T.-key
Type 2 	

If the following warning display, the display goes off if corrective action is taken.

- The ID codes of the F.A.S.T.-key and the vehicle cannot be verified

Type 1 	Someone may be carrying a F.A.S.T.-key with a different ID code, or the F.A.S.T.-key may not be within the operating range
Type 2 	
Type 1 	Refer to “F.A.S.T.-key take-out monitoring system” on page 5-18.
Type 2 	
Type 1 	The battery of the F.A.S.T.-key is run down
Type 2 	

- A door cannot be locked even when the driver’s or front passenger’s door lock/unlock switch is pressed.

Type 1 	Refer to “Key lock-in prevention system” on page 5-19.
Type 2 	
Type 1 	Refer to “Door ajar prevention system” on page 5-19.
Type 2 	
Type 1 	Refer to “Ignition switch turn-off reminder system” on page 5-20.
Type 2 	

F.A.S.T.-key take-out monitoring system

N00559801141

Type 1



Free-hand Advanced Security Transmitter (F.A.S.T.-key) (if so equipped)

Type 2



When the ignition switch is in a position other than the “LOCK (PUSH OFF)”, if the door(s) are opened, the F.A.S.T. - key is removed from the passenger compartment, and then the door(s) are closed, the warning display is displayed and the buzzer sounds 4 times as a warning since it’s impossible to verify the ID codes of the F.A.S.T.-key and vehicle.

NOTE

- The F.A.S.T.-key take-out monitoring system does not function if the F.A.S.T.-key is removed through a window without opening a door. This setting can be changed. See an authorized Mitsubishi Motors dealer for details.
- The warning may display even if the F.A.S.T.-key is in the operating range for starting the engine. The surrounding environment or electromagnetic waves may make it impossible to verify the ID codes of the F.A.S.T.-key and vehicle.

Key lock-in prevention system

N00559900103

Type 1



Type 2



When the ignition switch is in the “LOCK (PUSH OFF)” position, the F.A.S.T.-key is left in the passenger compartment, all the doors are closed, and someone tries to lock the vehicle by pressing the driver’s or front passenger’s door lock/unlock switch, the warning display is displayed and the buzzer sounds for about 3 seconds as a warning, and the doors cannot be locked.

If all the doors are manually locked and closed while the ignition switch is in the “LOCK (PUSH OFF)” position and the F.A.S.T.-key is left in the car, the doors will automatically unlock and a buzzer will sound for about 3 seconds.

Door ajar prevention system

N00560000104

Type 1



Type 2



When the ignition switch is in the “LOCK (PUSH OFF)” position, and someone tries to lock the vehicle by pressing the driver’s or front passenger’s door lock/unlock switch while one of the doors is not fully closed, the warning display is displayed and the buzzer sounds for about 3 seconds as a warning, and the doors cannot be locked.

5

Free-hand Advanced Security Transmitter (F.A.S.T.-key) (if so equipped)

Ignition switch turn-off reminder system

N00560100105

Type 1



5

Type 2



When the ignition switch is in a position other than “LOCK (PUSH OFF)”, all the doors are closed, and someone tries to lock the vehicle by pressing the driver’s or front passenger’s door lock/unlock switch, the warning display is displayed and the buzzer sounds for about 3 seconds as a warning, and the doors cannot be locked.

Steering wheel lock

N00514300025

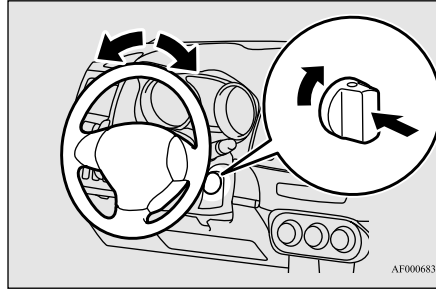

To lock

Turn the ignition switch to the “LOCK” position.

Turn the steering wheel until it is locked.

To unlock

Turn the ignition switch to the “ACC” position while moving the steering wheel slightly.

CAUTION

- Carry the key with you when leaving the vehicle.

CAUTION

- If your vehicle needs to be towed, turn the ignition switch to the “ACC” position to unlock the steering wheel.

NOTE

- If the front wheels are turned, the anti-theft lock may sometimes make it difficult to turn the ignition switch from “LOCK” to “ACC” position. Firmly turn the steering wheel to the left or to the right as you turn the ignition switch.

Starting

N00514601302

Tips for starting

- Do not operate the starter motor for longer than 15 seconds as this could run the battery down or damage the starter motor. If the engine does not start, turn the ignition switch back to the “LOCK” position, wait a few seconds, and then try again. Trying repeatedly with the engine or starter motor still turning will damage the starter mechanism.

Free-hand Advanced Security Transmitter (F.A.S.T.-key) (if so equipped)

- If the engine will not start because the battery is weak or discharged, refer to “Jump-starting the engine” on page 8-2 for instructions.
- A longer warm up period will only consume extra fuel. The engine is warmed up enough for driving when the bar graph of the engine coolant temperature display starts to move. Refer to “Interrupt display screen (With ignition switch in the “ON” position)” on page 5-119.
- On vehicles equipped with the Twin Clutch SST, the following may occur after the engine is started, but they do not indicate an abnormality.
 - You may hear operational sounds of the Twin Clutch SST and you may feel vibration in the vehicle body.
 - If you shift the gearshift lever into the “N” (NEUTRAL) position and depress the accelerator pedal, increases in the engine speed will be limited.

WARNING

- **Never run the engine in a closed or poorly ventilated area any longer than is needed to move your vehicle out of the area. Carbon monoxide gas, which is odorless and extremely poisonous, could build up and cause serious injury or death.**

CAUTION

- Do not push-start the vehicle.
- Do not run the engine at high rpms or drive at high speeds until the engine has had a chance to warm up.
- Release the ignition switch as soon as the engine starts. Otherwise, the starter motor will be damaged.

Starting the engine

Your vehicle is equipped with an electronically controlled fuel injection system. This is a system that automatically controls fuel injection. There is no need to depress the accelerator pedal when starting the engine.

The starter motor should not be run for more than 15 seconds at a time.

To prevent battery drain, wait a few seconds between attempts to restart the engine.

1. Make sure all occupants are properly seated with seat belts fastened.
2. Press and hold the brake pedal down with your right foot.
3. Press and hold the clutch pedal all the way down (manual transaxle).

NOTE

- For models equipped with a manual transaxle, the starter will not operate unless the clutch pedal is fully depressed (Clutch interlock). This is a safety feature.

4. On vehicles with manual transaxle, place the gearshift lever in the “N” (Neutral) position.

On vehicles with continuously variable transmission (CVT) or Twin Clutch SST, make sure the selector lever (CVT) or the gearshift lever (Twin Clutch SST) is in the “P” (PARK) position.

NOTE

- On vehicles with CVT, the starter will not operate unless the selector lever is in the “P” (PARK) or “N” (NEUTRAL) position. On vehicles with Twin Clutch SST, the starter will not operate unless the gearshift lever is in the “P” (PARK) position or the gearshift lever is in the “N” (NEUTRAL) position with the brake pedal depressed. For safety reasons, start the engine in the “P” (PARK) position so that the wheels are locked.

Free-hand Advanced Security Transmitter (F.A.S.T.-key) (if so equipped)

5

5. While pushing the ignition switch from “LOCK” (PUSH OFF) to “LOCK” (PUSH ON), set the ignition switch to the “ON” position and confirm that all warning lights and warning displays are operating properly.
6. Without pressing the accelerator pedal, slowly turn the ignition switch to the “START” position to start the engine. Release the ignition switch when the engine starts.

NOTE

- Minor noises may be heard on engine start-up. These will disappear as the engine warms up.

When the engine is hard to start

After several attempts, you may experience that the engine still does not start.

1. Make sure that all electric devices, such as lights, air conditioning blower and rear window defogger, are turned off.

2. While depressing the brake pedal on vehicles equipped with continuously variable transmission (CVT) or Twin Clutch SST or the clutch pedal on the vehicles equipped with manual transaxle, press the accelerator pedal halfway and hold it there, then crank the engine. Release the accelerator pedal, immediately after the engine starts.
3. If the engine still will not start, the engine could be flooded with too much gasoline. While depressing the brake pedal on vehicles equipped with CVT or Twin Clutch SST or the clutch pedal on the vehicles equipped with manual transaxle, push the accelerator pedal all the way down and hold it there, then crank the engine for 5 to 6 seconds. Return the ignition switch to the “LOCK” position and release the accelerator pedal. Wait a few seconds, and then crank the engine again for 5 to 6 seconds while depressing the brake pedal or the clutch pedal, but do not push the accelerator pedal. Release the ignition key if the engine starts. If the engine fails to start, repeat these procedures. If the engine still will not start, contact your local Mitsubishi Motors dealer or a repair facility of your choice for assistance.

Startability of continuously variable transmission (CVT) vehicles or Twin Clutch SST vehicles at extremely cold ambient temperature

When the ambient temperature is -4°F (-20°C) or lower on vehicles with CVT, or -22°F (-30°C) or lower on vehicles with Twin Clutch SST, it may not be possible to start from a standstill even with the selector lever (CVT) or the gearshift lever (Twin Clutch SST) in the “D” (DRIVE) or “R” (REVERSE) position.

This phenomenon occurs because the transaxle has not warmed up sufficiently; it does not indicate a problem. If this occurs, place the selector lever (CVT) or the gearshift lever (Twin Clutch SST) in the “P” (PARK) position and let the engine idle for at least 10 minutes.

The transaxle will warm up, and you will be able to drive normally.

Do not leave the vehicle during warm-up operation.

Free-hand Advanced Security Transmitter (F.A.S.T.-key) (if so equipped)

To operate using the emergency key

N0051480020

Emergency key

N00515200148

The emergency key is built into the F.A.S.T.-key.

When the F.A.S.T.-key cannot be used, such as when the battery of the F.A.S.T.-key or the vehicle has run down, the emergency key can be used to lock and unlock the driver's door and to start the engine.

To use the emergency key (1), unlock the lock knob (2) and remove it from the F.A.S.T.-key (3).

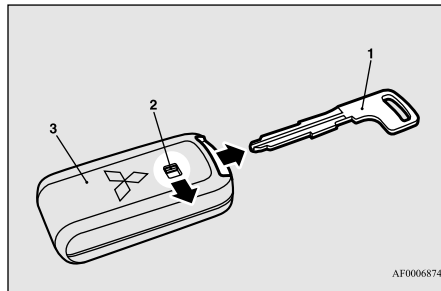

NOTE

- Only use the emergency key in an emergency. When the battery of the F.A.S.T.-key has run down, replace the battery as soon as possible and use it as a F.A.S.T.-key again.
- After using the emergency key, be sure to reinsert it into the F.A.S.T.-key.

To lock or unlock the driver's door with the emergency key

Turn the emergency key toward the front of the vehicle to lock the door. After checking that the door is locked, turn the emergency key back to the center and remove it.

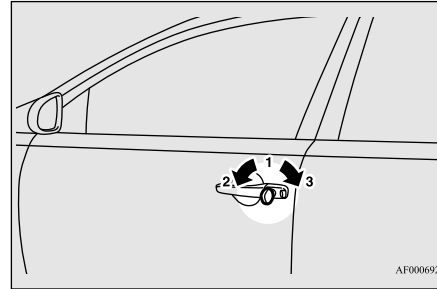

- 1- Insert or remove the emergency key
- 2- Lock
- 3- Unlock

Ignition switch

N00529301222

To prevent vehicle theft, only the emergency key with the pre-registered F.A.S.T.-key inserted can start the engine. (Electronic immobilizer function)

5

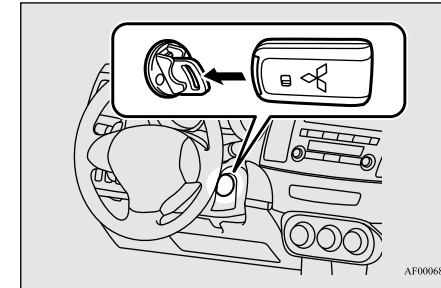

LOCK

The engine is off and the steering wheel is locked. The emergency key can be inserted and removed only when the ignition switch is in this position.

ACC

The electrical accessories can be used with the engine off.

Free-hand Advanced Security Transmitter (F.A.S.T.-key) (if so equipped)

ON

The engine will start only by using the emergency key with the F.A.S.T.-key inserted. It is possible to use all electrical accessories with only the emergency key.

5 START

Engages the starter. Release the emergency key when the engine starts. The ignition switch returns automatically to the “ON” position.

NOTE

- Your vehicle is equipped with an electronic immobilizer. To start the engine, the ID code which the F.A.S.T.-key sends must match the one registered to the immobilizer computer. (Refer to “Electronic immobilizer (Anti-theft starting system)” on page 5-28.)

To turn from “LOCK” to “ACC”

1. Remove the emergency key from the F.A.S.T.-key.
2. While pushing the lock release buttons (A), remove the cover of the ignition switch.

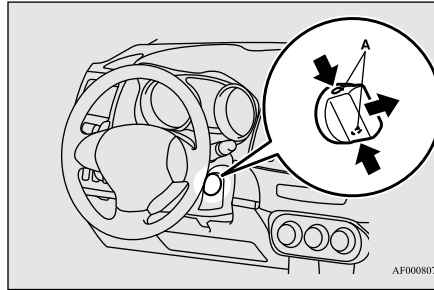

3. Insert the emergency key into the ignition switch, and slowly push and turn.

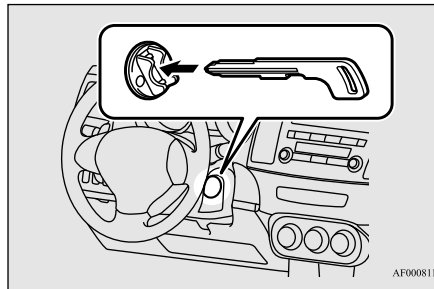

NOTE

- When the ignition switch cannot be turned from the “LOCK” position to the “ACC” position, turn the ignition switch while turning the steering wheel in both directions.

To turn from “ACC” to “LOCK”

1. [For vehicles with manual transaxle]
Push the emergency key in at the “ACC” position and keep it depressed until it is turned to the “LOCK” position, and remove.
[For vehicles with continuously variable transmission (CVT) or Twin Clutch SST]
First, set the selector lever (CVT) or the gearshift lever (Twin Clutch SST) to the “P” (PARK) position, and then slowly turn the ignition switch to the “LOCK” position while pressing it.

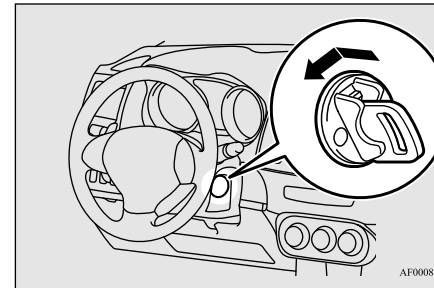

NOTE

- For vehicles with CVT or Twin Clutch SST, the emergency key cannot be removed unless the selector lever (CVT) or the gearshift lever (Twin Clutch SST) is set to the “P” (PARK) position.

Free-hand Advanced Security Transmitter (F.A.S.T.-key) (if so equipped)

2. Install the cover of the ignition switch.
3. Reinsert the emergency key into the F.A.S.T.-key.

NOTE

- Always install the cover of the ignition switch when not using the emergency key. Not doing so could cause damage if foreign material such as dust gets into the keyhole of the ignition switch.

CAUTION

- Do not turn the ignition switch to the LOCK position while the vehicle is moving. This will cause the steering wheel to lock, making it impossible to operate the vehicle.
- If the engine is stopped while driving, the power brake booster will stop functioning and greater effort for braking will be required. Also, the power steering system will not function and it will require greater effort to manually steer the vehicle.
- Do not leave the ignition switch in the "ON" position for a long time when the engine is not running. The battery will run down.
- Do not turn the ignition switch to the "START" position when the engine is running. It will damage the starter motor.

Steering wheel lock

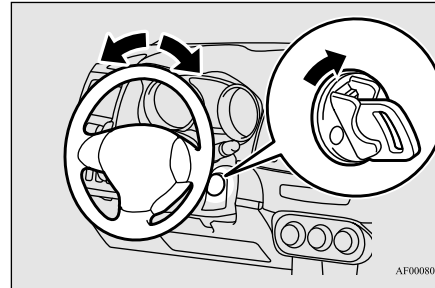

To lock

Turn the emergency key to the "LOCK" position.
Turn the steering wheel until it is locked.

To unlock

Turn the emergency key to the "ACC" position while moving the steering wheel slightly.

CAUTION

- Remove the emergency key when leaving the vehicle.
- If your vehicle needs to be towed, turn the emergency key to the "ACC" position to unlock the steering wheel.

NOTE

- If the front wheels are turned, the anti-theft lock may sometimes make it difficult to turn the emergency key from "LOCK" to "ACC". Firmly turn the steering wheel to the left or to the right as you turn the emergency key.

Starting

Tips for starting

- Do not operate the starter motor continuously for longer than 15 seconds as this could run the battery down or damage the starter motor. If the engine does not start, turn the emergency key back to the "LOCK" position, wait a few seconds, and then try again. Trying repeatedly with the engine or starter motor still turning will damage the starter mechanism.
- If the engine will not start because the battery is weak or discharged, refer to "Jump-starting the engine" on page 8-2 for instructions.
- A longer warm up period will only consume extra fuel. The engine is warmed up enough for driving when the bar graph of the engine coolant temperature display starts to move. Refer to "Interrupt display screen (With ignition switch in the "ON" position)" on page 5-119.

5

Free-hand Advanced Security Transmitter (F.A.S.T.-key) (if so equipped)

- On vehicles equipped with the Twin Clutch SST, the following may occur after the engine is started, but they do not indicate an abnormality.
- You may hear operational sounds of the Twin Clutch SST and you may feel vibration in the vehicle body.
- If you shift the gearshift lever into the “N” (NEUTRAL) position and depress the accelerator pedal, increases in the engine speed will be limited.

WARNING

● Never run the engine in a closed or poorly ventilated area any longer than is needed to move your vehicle out of the area. Carbon monoxide gas, which is odorless and extremely poisonous, could build up and cause serious injury or death.

CAUTION

- Do not push-start the vehicle.
- Do not run the engine at high rpms or drive at high speeds until the engine has had a chance to warm up.
- Release the emergency key as soon as the engine starts. It will damage the starter motor.

Starting the engine

5-26 Features and controls

Your vehicle is equipped with an electronically controlled fuel injection system. This is a system that automatically controls the fuel injection. There is no need to depress the accelerator pedal when starting the engine. The starter motor should not be run for more than 15 seconds at a time. To prevent battery drain, wait a few seconds between attempts to restart the engine.

1. Make sure all occupants are properly seated with seat belts fastened.
2. While pushing the lock release buttons (A), remove the cover of the ignition switch.

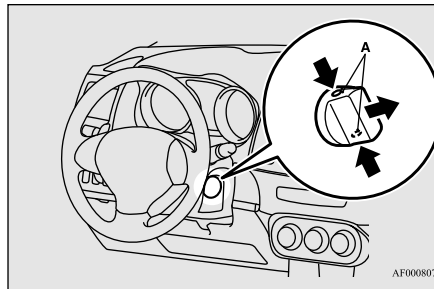

3. Insert the emergency key into the ignition switch.

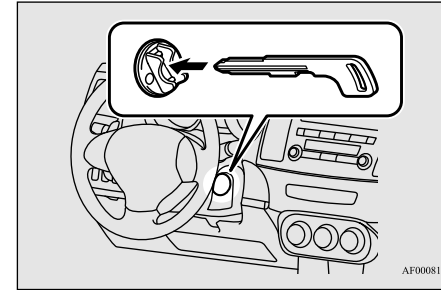

4. Insert the F.A.S.T.-key into the emergency key.

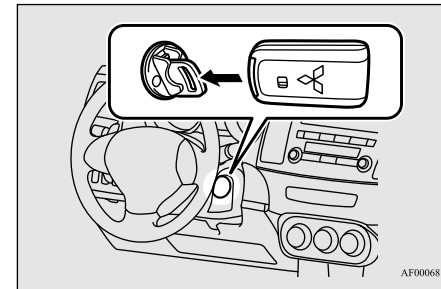

5. Press and hold the brake pedal down with your right foot.
6. Press and hold the clutch pedal all the way down (manual transaxle).

Free-hand Advanced Security Transmitter (F.A.S.T.-key) (if so equipped)

NOTE

- For models equipped with a manual transaxle, the starter will not operate unless the clutch pedal is fully depressed (Clutch interlock). This is a safety feature.

7. On vehicles with manual transaxle, place the gearshift lever in the “N” (Neutral) position.

On vehicles with CVT or Twin Clutch SST, make sure the selector lever (CVT) or the gearshift lever (Twin Clutch SST) is in the “P” (PARK) position.

NOTE

- On vehicles with continuously variable transmission (CVT) or Twin Clutch SST, the starter will not operate unless the selector lever (CVT) or the gearshift lever (Twin Clutch SST) is in the “P” (PARK) position or the selector lever (CVT) or the gearshift lever (Twin Clutch SST) is in the “N” (NEUTRAL) position with the brake pedal depressed.
For safety reasons, start the engine in the “P” (PARK) position so that the wheels are locked.

- Turn the emergency key with the F.A.S.T.-key to the “ON” position and make certain that all warning lights and warning displays are functioning properly before starting the engine.
- Turn the emergency key with the F.A.S.T.-key to the “START” position without pressing the accelerator pedal. Release the emergency key with the F.A.S.T.-key when the engine starts.
- Remove the F.A.S.T.-key from the emergency key.

NOTE

- Minor noises may be heard on engine start-up. These will disappear as the engine warms up.

WARNING

- **Make sure to remove the F.A.S.T.-key from the emergency key after the engine is started. If not removed, the F.A.S.T.-key could fall to the floor, which may interfere with pedal operation. Furthermore, the F.A.S.T.-key could prevent the driver’s knee airbag from inflating normally or could be propelled to cause serious injury if the airbag inflates.**

NOTE

- When using the emergency key to start the engine, first remove the key from the key holder. If the emergency key is attached to a key holder (key ring), it may become impossible to insert the keyless operation key into the emergency key, and it may prevent the engine from being started.

5**When the engine is hard to start**

After several attempts, you may experience that the engine still does not start.

- Make sure that all electric devices, such as lights, air conditioning blower and rear window defogger, are turned off.
- While depressing the brake pedal on vehicles equipped with continuously variable transmission (CVT) or Twin Clutch SST or the clutch pedal on the vehicles equipped with manual transaxle, press the accelerator pedal halfway and hold it there, then crank the engine. Release the accelerator pedal, immediately after the engine starts.

Free-hand Advanced Security Transmitter (F.A.S.T.-key) (if so equipped)

3. If the engine still will not start, the engine could be flooded with too much gasoline. While depressing the brake pedal on vehicles equipped with CVT or Twin Clutch SST or the clutch pedal on the vehicles equipped with manual transaxle, push the accelerator pedal all the way down and hold it there, then crank the engine for 5 to 6 seconds. Return the ignition switch to the "LOCK" position and release the accelerator pedal. Wait a few seconds, and then crank the engine again for 5 to 6 seconds while depressing the brake pedal or the clutch pedal, but do not push the accelerator pedal. Release the ignition key if the engine starts. If the engine fails to start, repeat these procedures. If the engine still will not start, contact your local Mitsubishi Motors dealer or a repair facility of your choice for assistance.

Startability of continuously variable transmission (CVT) vehicles or Twin Clutch SST vehicles at extremely cold ambient temperature

When the ambient temperature is -4°F (-20°C) or lower on vehicles with CVT, or -22°F (-30°C) or lower on vehicles with Twin Clutch SST, it may not be possible to start from a standstill even with the selector lever (CVT) or the gearshift lever (Twin

Clutch SST) in the "D" (DRIVE) or "R" (REVERSE) position.

This phenomenon occurs because the transaxle has not warmed up sufficiently; it does not indicate a problem. If this occurs, place the selector lever (CVT) or the gearshift lever (Twin Clutch SST) in the "P" (PARK) position and let the engine idle for at least 10 minutes.

The transaxle will warm up, and you will be able to drive normally.

Do not leave the vehicle during warm-up operation.

Electronic immobilizer (Anti-theft starting system)

N00529600101

The electronic immobilizer is designed to significantly reduce the possibility of vehicle theft. The purpose of the system is to immobilize the vehicle if an invalid start is attempted. A valid start attempt can only be achieved (subject to certain conditions) using a F.A.S.T.-Key "registered" to the immobilizer system.

All of the keys provided with your new vehicle have been programmed to the vehicle's electronics.

Replacement F.A.S.T.-key

N0056100039

Only the F.A.S.T.-keys that have been programmed to the vehicle's electronics can be used to start the vehicle.

If you lose the F.A.S.T.-key, you can order a F.A.S.T.-key from your authorized Mitsubishi Motors dealer by referring to the key number. To prevent vehicle theft, the ID codes for all the F.A.S.T.-keys except the one for the lost F.A.S.T.-key must be programmed again.

Take your vehicle and all the remaining F.A.S.T.-keys to your authorized Mitsubishi Motors dealer to have your ID codes programmed again.

Additional F.A.S.T.-key

N00561100030

To add a F.A.S.T.-key, you must already have two registered F.A.S.T.-keys. You need to register the ID code to the vehicle.

Registering the ID code can be done by your authorized Mitsubishi Motors dealer. Or it can be done by yourself (except for vehicles sold in Canada).

For you to register the ID code yourself, follow the "Customer F.A.S.T.-key programming" procedure below.

If you choose to have your authorized Mitsubishi Motors dealer register the ID code,

Free-hand Advanced Security Transmitter (F.A.S.T.-key) (if so equipped)

take your vehicle and all remaining F.A.S.T.-keys to your authorized Mitsubishi Motors dealer.

NOTE

- You are provided with two F.A.S.T.-keys, but you may register up to four F.A.S.T.-keys. You can obtain blank F.A.S.T.-keys specially cut for your vehicle from your Mitsubishi Motors dealer.

Customer F.A.S.T.-key programming (Except for vehicles sold in Canada)

N00561200073

You can program new F.A.S.T.-keys to the system if you have two valid (already registered) F.A.S.T.-keys, blank (not registered) F.A.S.T.-key and emergency key (specially cut for your vehicle at your Mitsubishi Motors dealer).

To use the new F.A.S.T.-key, it is necessary to register the key with both the electronic immobilizer and keyless entry system.

Also refer to “Keyless entry system: Customer F.A.S.T.-key programming” on page 5-33.

For F.A.S.T.-key programming, follow the procedures below.

1. Remove the emergency key from the F.A.S.T.-key. Refer to “Emergency key” on page 5-23.
2. While pushing the lock release buttons (A), remove the cover of the ignition switch.

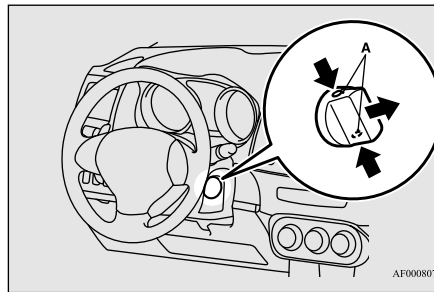

AF0008070

3. Insert the emergency key into the ignition switch.

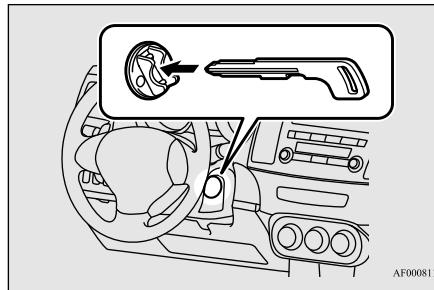

AF0008113

4. Insert the first valid F.A.S.T.-key into the emergency key.

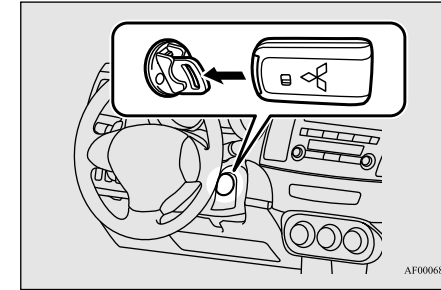

AF0006816

5

5. Turn the emergency key with the F.A.S.T.-key to the “ON” position for 5 seconds.
6. Turn the emergency key with the F.A.S.T.-key to the “LOCK” position. Within 30 seconds after doing so, remove the F.A.S.T.-key from the emergency key, insert the second valid F.A.S.T.-key into the emergency key and turn it to the “ON” position. About 10 seconds later, the immobilizer display will start to blink.

Free-hand Advanced Security Transmitter (F.A.S.T.-key) (if so equipped)

5

7. When the immobilizer display starts blinking, turn the second valid F.A.S.T.-key to the “LOCK” position and remove it. Within 30 seconds after doing so, insert a blank F.A.S.T.-key into the emergency key and turn it to the “ON” position. Perform this operation no more than 30 seconds after the immobilizer display starts blinking. When registration of the ID code is complete, the immobilizer display will come on for 3 seconds then go off. If an error occurs, the immobilizer display will go off during the procedure.



8. If you wish to register another F.A.S.T.-key, repeat the process from step 1.

NOTE

- Perform the operation when the interrupt display screen is not showing. The interrupt display screen may prevent you from seeing the immobilizer display.
- It is not possible to register a F.A.S.T.-key if:
 - the immobilizer display goes off during the procedure

NOTE

- the immobilizer display does not come on within 30 seconds after turning the ignition switch to the “ON” position with a blank F.A.S.T.-key
- The procedure will be terminated automatically if:
 - a period of 30 seconds or longer elapses from the moment when the first F.A.S.T.-key is turned to the “LOCK” position to the moment when the second F.A.S.T.-key is turned to the “ON” position
 - a period of 30 seconds or longer elapses from the moment when the second F.A.S.T.-key is turned to the “LOCK” position to the moment when the blank F.A.S.T.-key is turned to the “ON” position
- To use the new remote control transmitters, it is necessary to register the key with both the electronic immobilizer and keyless entry system. Also refer to “Keyless entry system: Customer F.A.S.T.-key programming” on page 5-33.

Keyless entry system

N00515500141

Press the remote control transmitter buttons to lock or unlock the doors and to open the trunk lid.

It can also help you signal for attention by setting off the panic alarm.

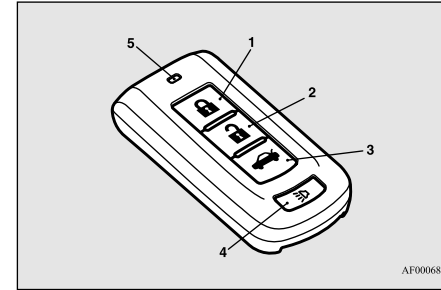

- 1- LOCK (🔒) button
- 2- UNLOCK (🔓) button
- 3- Trunk (🚪) button
- 4- PANIC (🚨) button
- 5- Indicator light

To lock the doors

N00544200036

Press the LOCK button (1) to lock all the doors.

The turn signal lights will also blink once.

NOTE

- If you press the LOCK button (1) twice quickly, the horn will sound once.

Free-hand Advanced Security Transmitter (F.A.S.T.-key) (if so equipped)

To unlock the doors

N00544301106

Press the UNLOCK button (2) to unlock the driver's door only. Within about 2 seconds, press the UNLOCK button one more time to unlock all the doors.

The dome light will turn on for 30 seconds. The turn signal lights will also blink twice. Except for vehicles with the rear seat arm rest, the front side-marker and parking lights will also turn on for about 30 seconds. Refer to "Welcome light" on page 5-151.

NOTE

- The door unlock function can be set so that all doors unlock when the UNLOCK button (2) is pressed once. Refer to "Setting of door unlock function" on page 5-32.

To open the trunk lid

N00544400012

Press the trunk button (3) twice within about 5 seconds and the trunk lid will be opened. The trunk lid must be closed manually after it has been opened.

Answerback function

N00544501065

Setting of the horn, turn signal lights and buzzer of the keyless entry system answer-

back function can be changed as required. This is done with the key removed from the ignition switch.

NOTE

- The answerback function does not operate when the key is in the ignition switch or any door is opened.

Horn deactivation/reactivation

The horn answerback function can be set to the following three conditions.

Each time the horn answerback function is set, a chime will sound to tell you the condition of the answerback function.

Number of chimes	Condition
One chime	The horn will not sound.
Two chimes	The horn will sound.
Four chimes	The horn will sound if the LOCK button is pressed twice quickly.

1. Turn the ignition switch to the "LOCK" position. If you started the engine with the key, remove the key from the ignition switch.

2. Open the driver's door and turn the combination headlights and dimmer switch to the "OFF" position.
3. Press the LOCK button (1) for 4 to 10 seconds and press the UNLOCK button (2) during this time.
4. Release in sequence the UNLOCK and LOCK buttons within 10 seconds of pressing the UNLOCK button in step 3.

5

Changing the setting of the turn signal lights answerback function

The turn signal lights answerback function can be set to the following seven conditions.

Each time the turn signal lights answerback function is set, a chime will sound to tell you the condition of the answerback function.

Number of chimes	Condition	
	To lock	To unlock
One chime	One flash	Two flashes
Two chimes	One flash	No flash
Three chimes	No flash	Two flashes
Four chimes	Two flashes	One flash
Five chimes	No flash	One flash
Six chimes	Two flashes	No flash
Seven chimes	No flash	No flash

5

Free-hand Advanced Security Transmitter (F.A.S.T.-key) (if so equipped)

1. Turn the ignition switch to the “LOCK” position. If you started the engine with the key, remove the key from the ignition switch.
2. Open the driver’s door and turn the combination headlights and dimmer switch to the “OFF” position.
3. Press the UNLOCK button (2) for 4 to 10 seconds and press the LOCK button (1) during this time.
4. Release in sequence the UNLOCK and LOCK buttons within 10 seconds of pressing the LOCK button in step 3.

Buzzer deactivation/reactivation

The buzzer answerback function can be turned ON or OFF as required.

Setting of door unlock function

N00544601112

The door unlock function can be set to the following two conditions. Each time the door unlock function is set, a chime will sound to tell you the condition of the door unlock function.

Number of chimes	Condition
One chime	All doors unlock
Two chimes	Driver’s door unlock only

1. Turn the ignition switch to the “LOCK” position. If you started the engine with the key, remove the key from the ignition switch.
2. Open the driver’s door and turn the combination headlights and dimmer switch to the “OFF” position.
3. Press the LOCK button (1) for 4 to 10 seconds and press the UNLOCK button (2) during this time.
4. Release in sequence the LOCK and UNLOCK buttons within 10 seconds of pressing the LOCK button in step 3.

Using the panic alarm

N00544700015

If you are near your vehicle and feel threatened, you can activate the alarm to call attention as follows:

1. Press the PANIC button (4) for more than 1 second.
2. The headlights will blink on and off and the horn will sound intermittently for about 3 minutes.
3. To turn off the alarm, press any button on the remote control transmitter.

Replacement F.A.S.T.-keys

N00561300029

Only a F.A.S.T.-key, which has been programmed into the vehicle’s electronics, can lock and unlock all the doors, and start the engine.

If you lose the F.A.S.T.-key, you can order a F.A.S.T.-key from your authorized Mitsubishi Motors dealer by referring to the key number. To prevent vehicle theft, the ID codes for all the F.A.S.T.-keys except the one for the lost F.A.S.T.-key must be programmed again.

Take your vehicle and all the remaining F.A.S.T.-keys to your authorized Mitsubishi Motors dealer to have your ID codes programmed again.

Additional F.A.S.T.-keys

N00561400020

To add a F.A.S.T.-key, you must already have two registered F.A.S.T.-keys.

Registering the ID code can be done by your authorized Mitsubishi Motors dealer. Or it can be done by yourself (except for vehicles sold in Canada). For you to register the ID code yourself, follow the “Customer F.A.S.T.-key programming” procedure below. If you choose to have your authorized Mitsubishi Motors dealer register the ID code, take your vehicle and all remaining F.A.S.T.-

Free-hand Advanced Security Transmitter (F.A.S.T.-key) (if so equipped)

keys to your authorized Mitsubishi Motors dealer.

NOTE

- You are provided with two F.A.S.T.-keys, but you may register up to four F.A.S.T.-keys.

Customer F.A.S.T.-key programming (Except for vehicles sold in Canada)

N0056150116

You can program new F.A.S.T.-keys to the system if you have two valid (already registered) F.A.S.T.-keys, blank (not registered) F.A.S.T.-key and emergency key (specially cut for your vehicle at your Mitsubishi Motors dealer).

To use the new F.A.S.T.-key, it is necessary to register the key with both the electronic immobilizer and keyless entry system.

Also refer to “Electronic immobilizer: Customer F.A.S.T.-key programming” on page 5-29.

For F.A.S.T.-key programming, follow the procedures below.

1. Remove the emergency key from the F.A.S.T.-key. Refer to “Emergency key” on page 5-23.

2. While pushing the lock release buttons (A), remove the cover of the ignition switch.

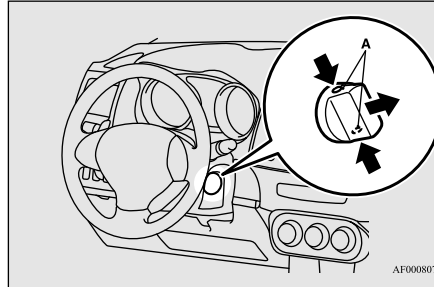

AF0008070

3. Insert the emergency key into the ignition switch.

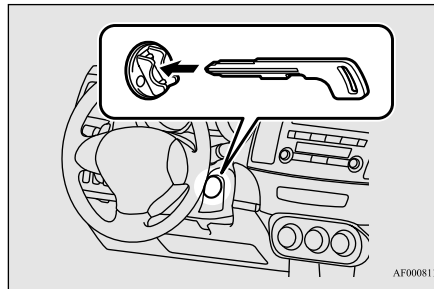

AF0008113

4. Insert the valid F.A.S.T.-key into the emergency key.

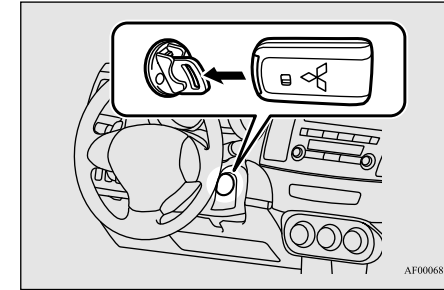

AF0006816

5

5. Turn the emergency key with F.A.S.T.-key to the “ON” position. (Perform the following procedure within 30 seconds)
6. Remove the F.A.S.T.-key from the emergency key.
7. With the first valid F.A.S.T.-key, press the UNLOCK button for 4 to 10 seconds and press the LOCK button during this time.
8. Release in sequence the LOCK and UNLOCK buttons within 10 seconds of pressing the LOCK button in step 7. (Perform the following procedure within 30 seconds)
9. With the second valid F.A.S.T.-key, press the UNLOCK button for 4 to 10 seconds and press the LOCK button during this time.

Free-hand Advanced Security Transmitter (F.A.S.T.-key) (if so equipped)

5

10. Release in sequence the LOCK and UNLOCK buttons within 10 seconds of pressing the LOCK button in step 9, and the immobilizer display will blink on the information screen in the multi-information display. (Perform the following procedure within 60 seconds)
11. Press the LOCK button twice with the blank F.A.S.T.-key and the immobilizer display will come on for 30 seconds on the information screen in the multi-information display.
12. This completes the registration of the F.A.S.T.-key.

NOTE

- The indicator light (5) comes on each time a button is pressed.
- The keyless entry system does not work if the key is in the ignition switch.
- The F.A.S.T.-key can be used from about 40 feet (12 m) away. However, this distance may change if your vehicle is near a TV transmitting tower, a power station, or a radio station.
- If the UNLOCK button (2) is pressed when all doors are locked and no doors are opened within about 30 seconds, the doors will automatically re-lock.
- If the following conditions are observed after pressing the buttons on the remote control transmitter, the battery in the remote control transmitter may need to be replaced.

NOTE

- The doors cannot be locked or unlocked.
 - The trunk lid cannot be opened.
 - The panic alarm cannot be operated.
 - The indicator light (5) is dim or does not come on.
 - If you lose your F.A.S.T.-key, please contact an authorized Mitsubishi Motors dealer for a replacement.
 - If you wish to obtain an additional F.A.S.T.-key, please contact an authorized Mitsubishi Motors dealer. A maximum of four F.A.S.T.-key can be programmed for your vehicle.
 - To use the new remote control transmitters, it is necessary to register the key with both the electronic immobilizer and keyless entry system.
- Also refer to “Electronic immobilizer (Anti-theft starting system): Customer F.A.S.T.-key programming” on page 5-29.

General information

N00561601074

Your F.A.S.T.-key operates on a radio frequency subject to Federal Communications Commission (FCC) Rules (For vehicles sold in U.S.A.) and Industry Canada Rules (For vehicles sold in Canada). This device complies with Part 15 of FCC Rules and Industry Canada licence-exempt RSS standard(s). Operation is subject to the following two conditions.

- This device may not cause harmful interference.
- This device must accept any interference received, including interference that may cause undesired operation.

CAUTION

- Changes or modifications not expressly approved by the manufacturer for compliance could void the user's authority to operate the equipment.

Procedure for replacing the remote control transmitter battery

N00561700081

1. Before replacing the battery, remove static electricity from your body by touching a metal grounded object.
2. With the Mitsubishi mark facing you, insert the cloth-covered tip of a flat blade screwdriver into the notch in the remote control transmitter case and use it to open the case.

Door locks

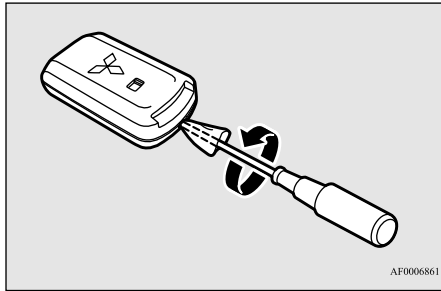

AF0006861

5. Close the remote control transmitter case firmly.
6. Check the keyless entry system to see that it works.

NOTE

- You may purchase a replacement battery at an electric appliance store.
- Your authorized Mitsubishi Motors dealer can replace the battery for you if you prefer.

NOTE

- Be sure to perform the procedure with the Mitsubishi mark facing you. If the Mitsubishi mark is not facing you when you open the remote control transmitter case, the transmitter may come out.

3. Remove the old battery.
4. Install a new battery with the +side (A) up.

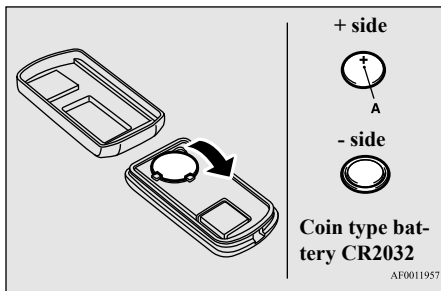

AF0011957

CAUTION

- When the remote control transmitter case is opened, be careful to keep water, dust, etc. out. Also, do not touch the internal components.

Door locks

N00509200491

WARNING

- **Make sure all doors are tightly closed and locked while driving.**
- **Locked doors, in combination with the use of seat belts, can help reduce the risk of ejection in an accident.**
- **Locked doors can help keep passengers, especially small children, from opening doors and falling out of moving vehicles.**

WARNING

- **Locked doors can help prevent outsiders from gaining access to your vehicle when you slow or come to a stop.**
- **Lock your vehicle whenever you leave it. Children who get into unlocked vehicles may not be able to get out. Children trapped inside vehicles can quickly be overcome by heat and suffer serious injury or death due to heat stroke.**
- **Never leave children unattended inside a vehicle. In addition to the risk of heat stroke, children can activate switches and controls, resulting in an injury or fatal accident.**

NOTE

- When locking or unlocking with the key, only the driver's door will be locked or unlocked. To lock or unlock all doors, use the power door lock switches, the keyless entry system, the F.A.S.T.-key or the remote control transmitter of the F.A.S.T.-key. Refer to "Power door locks" on page 5-37, "Keyless entry system" on page 5-7 and 5-30, and "To operate using the F.A.S.T.-key" on page 5-14.
- In vehicles equipped with the F.A.S.T.-key, the driver's door can be locked and unlocked using the emergency key. Refer to "Emergency key" on page 5-23.

Door locks

To lock or unlock the front doors with the key

Turn the key toward the front of the vehicle to lock the door. After checking that the door is locked, turn the key back to the center and remove it.

5

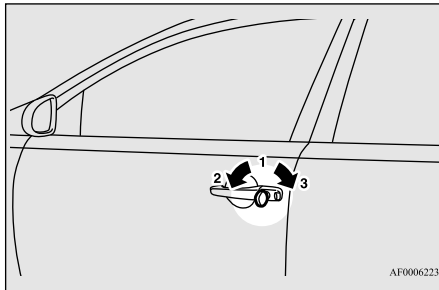

- 1- Insert or remove the key
- 2- Lock
- 3- Unlock

To lock or unlock the door from the inside

Move the lock knob to the lock position to lock the door. All doors should be kept locked while driving.

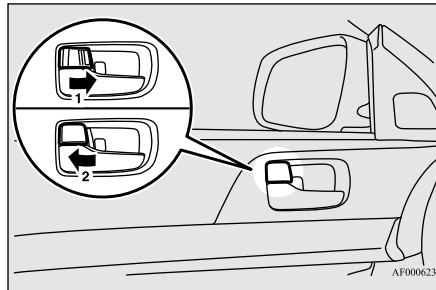

- 1- Lock
- 2- Unlock

The driver's door can be unlocked without using the lock knob by pulling on the inside door handle.

To lock the door without using the key

1. Move the inside lock knob to the locked position.

2. Be sure the keys are not inside the vehicle. Close the door.

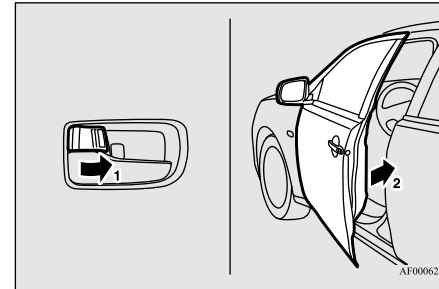

Key reminder system

N00549600178

When a key was used to start the engine

Type 1



Type 2



If the ignition switch is turned off and the driver's door is opened with the key in the ignition switch, the key reminder buzzer will sound intermittently to remind you to remove the key.

The warning display will be displayed on the information screen in the multi-information display.

Lock out protection

N00517300039

When you push the lock knob forward or lock the door with the power door lock switch in both of the following conditions, the lock knob will automatically return to the unlocked position.

- The key is in the ignition switch or the ignition switch is in the "ACC" or "ON" position.
- Driver's door or front passenger door is opened.

Ignition switch return reminder system

N00503800121

When the F.A.S.T.-key was used to start the engine

Type 1



Type 2



If the driver's door is opened while the ignition switch is in a position other than "LOCK" (PUSH OFF), the ignition switch return reminder buzzer will sound intermittently to remind you to return the ignition switch to the "LOCK" (PUSH OFF) position. The warning display will be displayed on the information screen in the multi-information display.

Power door locks

N00509300564

NOTE

- When locking or unlocking with the key on the driver's door, only the driver's door will lock or unlock.
- Repeated continuous operation between lock and unlock could activate the power door locking systems built-in protection circuit and prevent the system from operating. If this occurs, wait about 1 minute before operating the inside lock knob or the key.

5

Power door locks

To lock and unlock the doors

Using the power door lock switch

5

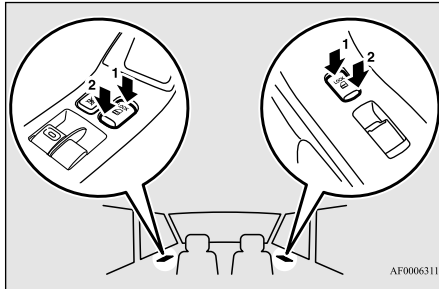

- 1- Lock
- 2- Unlock

All of the doors can be locked or unlocked by pressing the power door lock switch on the driver's or the front passenger's door.

Using the key

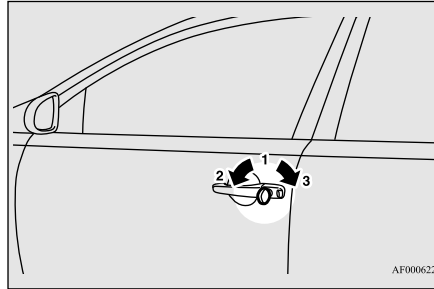

- 1- Insert or remove the emergency key.
- 2- Lock
- 3- Unlock

Turn the key in the driver's door lock once in the unlocking direction, and the driver's door will be unlocked.

To unlock the doors

N00517701131

You can select either the function to unlock the doors using the ignition switch position or the function to unlock the doors using the selector lever {continuously variable transmission (CVT)} position or the gearshift lever (Twin Clutch SST) position. These functions are not activated when the vehicle is shipped from the factory. To activate or deactivate these functions, please contact your authorized Mitsubishi Motors dealer.

Using the ignition switch position

All doors will unlock when the ignition switch is turned to the "LOCK" position.

Using the selector lever {continuously variable transmission (CVT)} position or the gearshift lever (Twin Clutch SST) position

All doors will unlock when the selector lever (CVT) or the gearshift lever (Twin Clutch SST) is moved to the "P" (PARK) position with the ignition switch in the "ON" position.

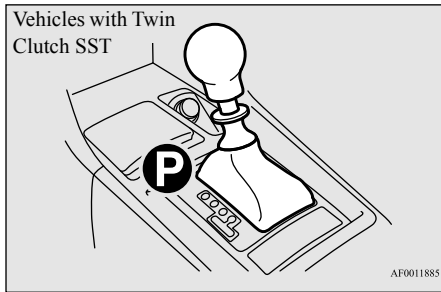
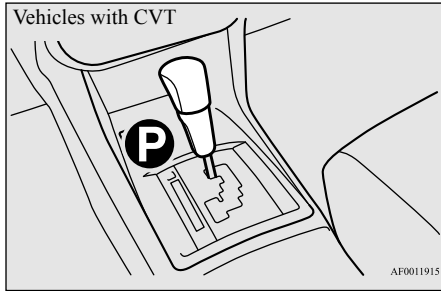

“Child safety locks” for rear door

N00509400190

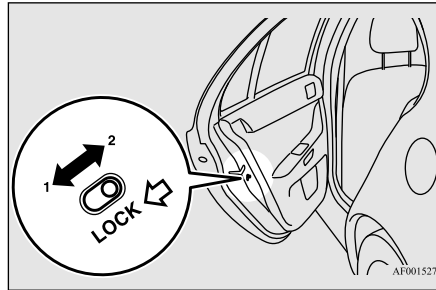

- 1- To lock
- 2- To release

Child safety locks help prevent rear passengers, especially children, from opening the rear door using the inside door handle.

A lock lever for the child safety lock is provided on each rear door.

When the lever is in the lock position (1), the rear door cannot be opened using the inside door handle.

To open the rear door when the child safety lock lever is in the lock position, pull the outside door handle.

When the lever is in the release position (2), the child safety lock is released and the rear

“Child safety locks” for rear door

door can be opened using the inside door handle.

⚠ WARNING

- Always keep the doors tightly closed and locked when driving. An unlocked door may be accidentally opened by a passenger, especially by a child who could fall out. Also, if the doors are not locked, there is a greater risk of someone being thrown from the vehicle in an accident.

5

Trunk lid

N00509501198

⚠ WARNING

- It is dangerous to drive with the trunk lid open since carbon monoxide (CO) gas can enter the cabin. CO is an invisible, odorless gas that can cause unconsciousness and even death.
- Do not allow children to have access to the trunk, either by climbing into the trunk from outside or through the inside of the vehicle. Always close the trunk lid when your vehicle is unattended. If trapped in the trunk, it is possible to escape from the trunk by using the inside emergency trunk release lever. (See “Inside emergency trunk lid release” on page 5-41.)

Trunk lid

⚠ CAUTION

- Do not stand behind the exhaust pipe when loading and unloading luggage. Heat from the exhaust could lead to burns.

5

To open

Operation from outside the vehicle

Using the key (Vehicles with key cylinder)

Insert the key and turn it clockwise.

The trunk lid will pop up slightly. Lift it to open the trunk.

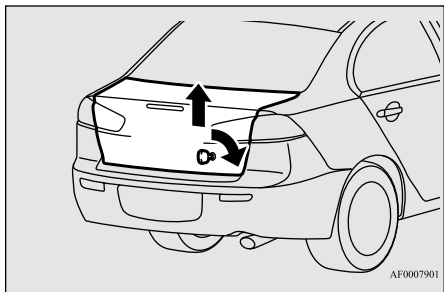

Using the remote control transmitter (Vehicles with keyless entry system or F.A.S.T.-key)

Press the trunk button (Vehicles with keyless entry system or F.A.S.T.-key) or OPEN switch (Vehicles with F.A.S.T.-key). (See “Keyless entry system” on page 5-7, 5-30 or “Free-hand Advanced Security Transmitter (F.A.S.T.-key)” on page 5-12.)

The trunk lid will pop up to slightly. Lift it to open the trunk.

Operation from inside the vehicle

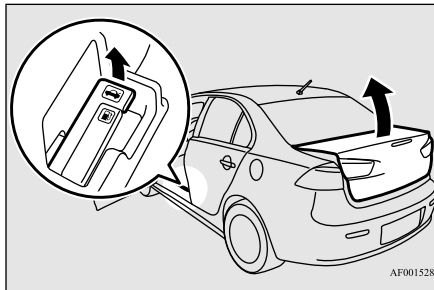

Pull the trunk lid release lever, located to the left of the driver's seat, up to open the trunk.

⚠ CAUTION

- Do not use the trunk lid release lever while the vehicle is moving. If the trunk lid is opened, objects in the trunk could fall onto the road and cause an accident.

NOTE

- The trunk area light comes on when the trunk lid is opened, and goes out when it is closed.
- The trunk area light remains illuminated for a certain period and then goes off automatically. Refer to “Interior light auto-cutout function (dome light and other lights)” on page 5-187.

To close

Pull the trunk lid downward as illustrated. Gently slam the trunk lid from the outside so

that it is completely closed. Always ensure the trunk lid is securely closed.

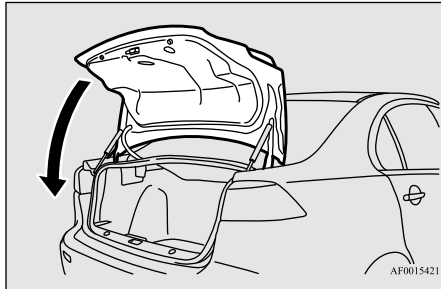

⚠ CAUTION

- Be careful to prevent catching anyone's fingers when closing the trunk lid.
- Before starting the vehicle, be sure to confirm that the trunk lid is closed. If the trunk lid opens while driving the vehicle, objects stored in the trunk could fall out onto the road.

📖 NOTE

- Gas struts (A) are installed in the locations illustrated to support the trunk lid. Please observe the following in order to prevent damage or faulty operation.
 - Do not touch, push or pull the gas struts when closing the trunk lid.
 - Do not attach any plastic material, tape, etc., to the gas struts.

📖 NOTE

- Do not tie string, etc., around the gas struts.
- Do not hang any object on the gas struts.

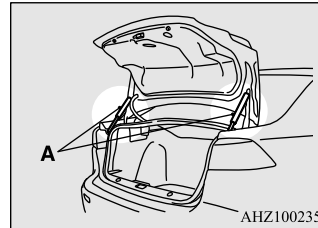

Inside emergency trunk lid release

N00509800165

The emergency trunk lid release is designed to provide a way to open the trunk lid from inside the trunk. It was developed to help prevent death and serious injuries to children who might become locked inside a vehicle trunk.

The emergency trunk lid release lever (see illustration) is mounted on the trunk lid.

The lever glows in the dark after exposure to sunlight.

Inside emergency trunk lid release

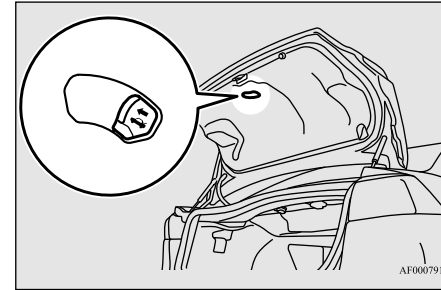

5

You and your family should familiarize yourselves with the location and operation of the emergency trunk lid release lever. Children should be taught not to play in or around vehicles.

⚠ WARNING

- Children should never be left unsupervised in or around vehicles.
- Unsupervised children could lock themselves in an open vehicle or trunk.
- People trapped inside a vehicle or trunk, even if only for a short period of time, can quickly die from suffocation or heat stroke, especially on hot days. Interior temperatures in vehicles can rise in minutes.
- Keep your vehicle doors locked and the trunk lid closed when not in use. Keep your vehicle keys away from children.

Theft-alarm system

To open the trunk from the inside, move the lever (A) in the direction of the arrow on the lever. Push up on the trunk lid to open the trunk and climb out.

5

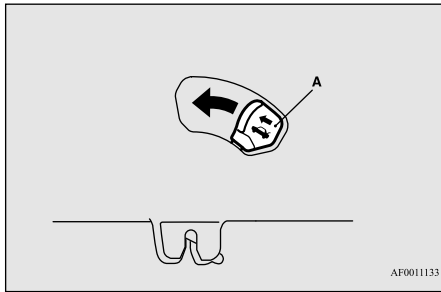

CAUTION

- When loading the trunk, place your things so that they will not touch the emergency trunk lid release lever when you close the trunk. Otherwise you could damage the lever and make it unusable.

Theft-alarm system

N00510200185

The theft-alarm system is designed to provide protection from unauthorized entry into the vehicle. This system is operated in three stages: the first is the “armed” stage, the second is the “alarm” stage, and third is the “disarmed” stage. If triggered, the system

5-42 Features and controls

provides both audible and visual alarm signals.

CAUTION

- Do not modify or add parts to the theft-alarm system. Doing so could cause the theft-alarm to malfunction.

Armed stage

N00510301183

Park the vehicle and stop the engine. Arm the system as described below.

1. Turn the ignition switch to the “LOCK” position. Also, if a key was used to start the engine, remove the key from the ignition switch.
2. Make sure that the trunk lid and engine hood are closed.
3. Lock all doors by either the remote control transmitter or the F.A.S.T.-key.

Arm the system and leave

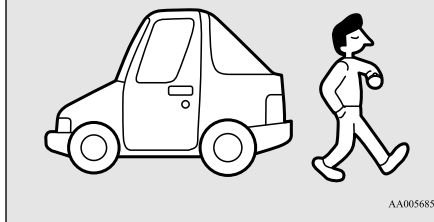

At this time, the theft-alarm indicator (A) on the audio panel flashes for confirmation.

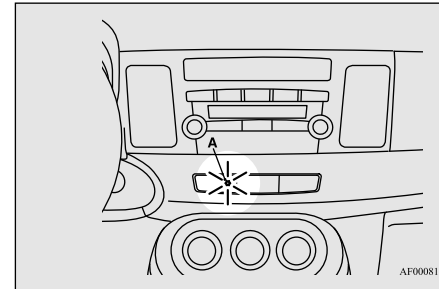

4. The system has entered the armed stage after about 20 seconds, when the theft-alarm indicator (A) flashing becomes slower.

The theft-alarm indicator (A) continues to flash while the system is in the armed stage.

NOTE

- If the engine hood or the trunk lid is open, the theft-alarm indicator (A) illuminates and the system cannot enter the armed stage. The system enters the armed stage about 20 seconds after the engine hood or the trunk lid is closed.
- The system will be disarmed if, while the theft-alarm indicator (A) is illuminated, all doors are unlocked by remote control transmitter or the F.A.S.T.-key.

Theft-alarm system

NOTE

- The system will be disarmed if, while the theft-alarm indicator is illuminated, the ignition switch is turned to the “ON” position.
- The system will not be armed if a door or the trunk lid or the engine hood is not completely closed. If this happens, rearm the system as described above.

Alarm stage

N00510401197

The alarm will be activated if any of the following occur while the vehicle is parked and the system is armed.

- One of the doors is opened without using the remote control transmitter or the F.A.S.T.-key.
- The engine hood or the trunk lid is opened.

Type of alarm

When the alarm is activated:

1. The headlights blink on and off for 3 minutes.
After 3 minutes the headlights automatically shut off.
2. The horn will sound intermittently for 3 minutes.

Horn sounds!
Headlights blink on and off!



AF0008168

NOTE

- The alarm will continue to operate for 3 minutes. At the end of that period, the alarm will automatically shut off to save battery power. The system will then be rearmed until the proper disarming step is taken.
- The alarm will resume if unauthorized actions are taken again, even if the alarm has stopped.
- While the alarm is operating, a warning is displayed on the information screen in the multi-information display.

Type 1



Type 2



Alarm deactivation

5

The alarm can be deactivated in the following ways.

- By using the remote control transmitter or the F.A.S.T.-key to lock or unlock the door.
- Turn the ignition switch to the “ON” position.

Disarmed stage

N00510501169

The system will be disarmed if the following operation is performed.

- The ignition switch is turned to the “ON” position.
- All doors are unlocked by the remote control transmitter or the F.A.S.T.-key.

Power windows

5

Disarm...by remote control transmitter or F.A.S.T.-key

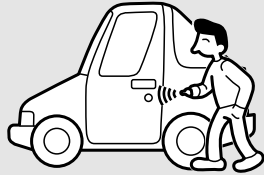

AA0070940

NOTE

- If the UNLOCK button is pressed when all doors are closed and no door is opened within approximately 30 seconds, re-arming will automatically occur.
- The amount of time after unlocking until the vehicle relocks automatically can be adjusted. See an authorized Mitsubishi Motors dealer for details.
- Once the system has been disarmed, it cannot be rearmed except by repeating the arming procedure.

Testing the theft-alarm system

N00510601128

Use the following procedure to test the system:

1. Lower the driver's window.

2. Arm the system as explained in "Armed stage".
3. Make sure that the theft-alarm indicator comes on and flashes for approximately 20 seconds.
4. Wait a few seconds and then unlock the driver's side door by using the inside door lock knob and open the door.
5. Check to be sure that the horn sounds intermittently and the headlights blink on and off when a door is opened.
6. Disarm the system by unlocking all doors by the remote control transmitter or the F.A.S.T.-key.

Power windows

N00510800367

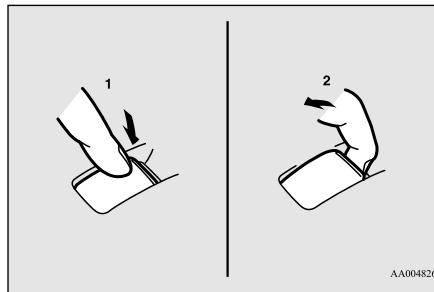

AA0048266

- 1- Open (down)
- 2- Close (up)

NOTE

- Never try to operate the main switch and sub switch in different directions at the same time. This will freeze the window in position.
- Operating the power windows repeatedly with the engine stopped will run down the battery. Use the window switches only while the engine is running.

WARNING

- Before operating the power windows, make sure that nothing can be trapped (head, hands, fingers, etc.) in the window.
- Never leave the vehicle with the key in the ignition switch.
- Never leave a child alone in the vehicle.

Main switch

The main switch located on the driver's door can be used to operate all door windows.

A window can be opened or closed by operating the corresponding switch.

Press the switch down to open the window, and pull up the switch to close it.

If the driver's door window switch is fully pressed down/pulled up, the driver's door window automatically opens/closes completely.

Power windows

If you want to stop the window movement, operate the switch lightly in the reverse direction.

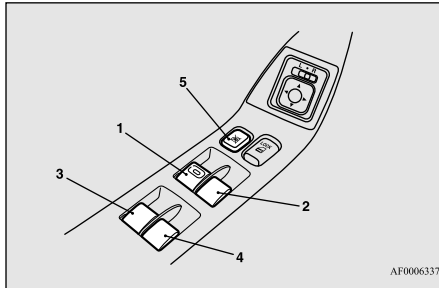

- 1- Driver's door window switch
- 2- Front passenger door window switch
- 3- Left rear door window switch
- 4- Right rear door window switch
- 5- Window lock switch

Sub switch

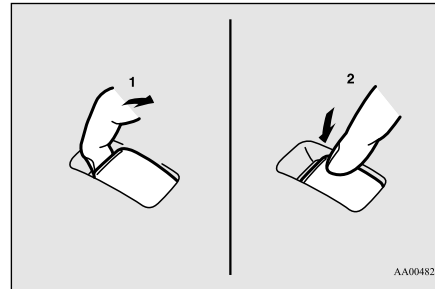

- 1- Close (up)
- 2- Open (down)

Each sub switch can be used for its own passenger door window, unless the driver's window lock switch is activated.

Timer function

The power windows can be run up or down when the ignition switch is in the "ON" position.

The door windows can be opened or closed for a 30 second period after the ignition switch is turned to the "ACC" or "LOCK" position. However, once the driver's door or the front passenger's door is opened, the power windows cannot be operated.

Safety mechanism (Driver's door window only)

N0052880092

If a hand or head is trapped, for safety the door window is automatically lowered a little. After the door window is lowered, pull up the switch again to close the door window.

5

! WARNING

- If the safety mechanism is activated three or more times successively, the safety mechanism will be temporarily cancelled. If a hand or head subsequently gets trapped, a serious injury can result.

! CAUTION

- The safety mechanism is deactivated just before the door window closes. This allows the door window to close completely. Therefore be especially careful that fingers are not trapped in the door window opening.
- The safety mechanism is deactivated while the switch is pressed. Therefore be especially careful that fingers are not trapped in the door window opening.
- Do not deliberately trap your hands or head in order to activate the safety mechanism. Your hand or head could be trapped and personal injury could result.

5

Sunroof (if so equipped)

NOTE

- The safety mechanism can be activated if the driving conditions or other circumstances cause the door window to be subjected to a physical shock similar to that caused by trapped hand or head.
- If the safety mechanism is activated 3 or more times consecutively, the safety mechanism is deactivated and normal closing of the door window will be aborted. Use the following method to return to normal operation.
 1. If the door window is open, repeatedly pull up the power window switch to fully close the door window.
 2. With fully closing the window, release the switch and then pull up the switch again for about 1 second.

Lock switch

N00549000127

When this switch is in the lock mode, the main switch for passenger door window and the sub switch cannot be used to open or close the door window, and the main switch

will open or close only the driver's door window. To unlock the switch, press it again.

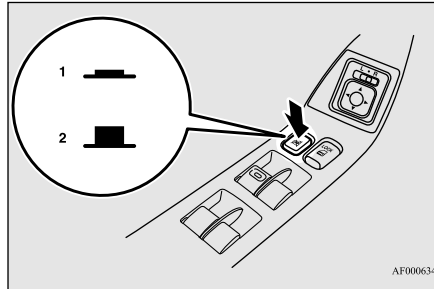

AF0006340

- 1- Lock
- 2- Unlock

WARNING

- Before driving with a child in the vehicle, be sure to lock the window switch to make it inoperative. Children tampering with the switch could easily trap their hands or heads in the window.

What to do if you hear wind buffeting when driving

N00551400014

Wind buffeting can be described as the perception of pressure on the ears or a booming or rumbling sound. Your vehicle may exhibit wind buffeting when driving with one or both

rear door windows down or partially opened. This is a normal occurrence that can be minimized. If the buffeting occurs with the rear door windows open, open the front door windows as well as the rear door windows to minimize the condition.

Sunroof (if so equipped)

N00511000656

WARNING

- Do not stick your head, hands or anything else in the sunroof opening.
- Before operating the sunroof, make sure that nothing can be trapped (head, hands, fingers, etc.).
- Never leave a child (or other person who is incapable of safely operating the sunroof switch) alone in the vehicle.

The sunroof can be opened and closed with the ignition switch in the "ON" position.

Sunroof (if so equipped)

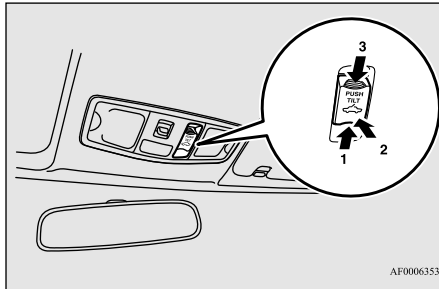
**To open**

Press the switch (1), the sunroof automatically opens and the sunroof will stop several centimeters this side of the full open position. Press the switch (1) again, and the sunroof will be fully open.

To stop the moving sunroof, press the switch.

NOTE

- The sunroof stops just before reaching the fully open position. If the vehicle is driven with the sunroof in this position, wind buffeting is lower than with the sunroof fully open.

To close

Press the switch (3), the sunroof automatically closes.

To stop the moving sunroof, press the switch.

To tilt up

When the switch (2) is pressed, the rear edge of sunroof raises for ventilation.

To tilt down

Press the switch (3).

Timer function

The sunroof can be operated when the ignition switch is in the "ON" position. The sunroof can be opened or closed for a 30 seconds period after the ignition switch is turned to the "ACC" or "LOCK". However, once the driver's door or the front passenger's door is opened, the sunroof cannot be operated until the ignition switch is turned on again.

Safety mechanism

If a hand or head is trapped in the closing sunroof opening, the safety mechanism will cause the sunroof to re-open automatically. The opened sunroof will become operational again after a few seconds.

If the safety mechanism is activated 5 or more times consecutively, normal closing of the sunroof will be aborted.

As an emergency measure, the sunroof can be closed in small increments until it is completely closed by repeatedly pressing the switch (2).

After performing the emergency measure, consult an authorized Mitsubishi Motors dealer.

5**NOTE**

- The safety mechanism can be activated if the driving conditions or other circumstances cause the sunroof to be subjected to a physical shock similar to that caused by a trapped hand or head.

CAUTION

- The safety mechanism is deactivated just before the sunroof closes. This allows the sunroof to close completely. Therefore be especially careful that fingers are not trapped in the sunroof opening.

Parking brake

CAUTION

- The safety mechanism is deactivated while the switch (2) is pressed. Therefore be especially careful that fingers are not trapped in the sunroof opening.
- Do not deliberately trap your hands or head in order to activate the safety mechanism. Personal injury and malfunction of the sunroof could result.

5

Sunshade

The sunshade can be opened or closed manually while the sunroof is closed. When the sunroof is opened, the sunshade will also open automatically.

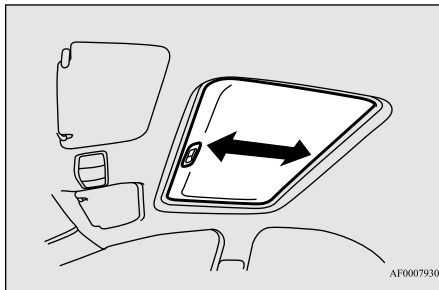

CAUTION

- Do not attempt to close the sunshade when the sunroof is opened.

5-48 Features and controls

CAUTION

- Be careful that hands are not trapped when closing the sunshade.

NOTE

- Be sure to tilt down the sunroof before closing the sunshade.
- When leaving the vehicle unattended, be sure to close the sunroof and without the ignition key.
- Do not try to operate the sunroof if it is frozen closed (after snowfall or during extreme cold).
- Do not sit on or place heavy luggage on the sunroof or roof opening edge.
- Do not apply any force that may cause damage to the sunroof.
- Release the switch when the sunroof has reached a completely open or completely closed position.
- If the sunroof does not operate when the sunroof switch is operated, release the switch and check whether something is trapped by the sunroof. If nothing is trapped, have the sunroof checked at an authorized Mitsubishi Motors dealer.
- Be careful when tilting up the sunroof if a ski carrier or a roof carrier is installed. Depending on the model of ski carrier or roof carrier, the sunroof may contact the carrier when the sunroof is tilted up.

NOTE

- Be sure to close the sunroof completely when washing the vehicle or when leaving the vehicle.
- Do not put any wax on the weatherstrip (black rubber) around the sunroof opening. If it is waxed, the weatherstrip cannot maintain a weatherproof seal with the sunroof.
- After washing the vehicle or after rain be sure to wipe off any water that is on the sunroof before operating it.
- Operating the sunroof repeatedly with the engine turned off will run down the battery. Operate the sunroof only while the engine is running.

Parking brake

N00511400298

To park the vehicle, first bring it to a complete stop, fully engage the parking brake, and then move the gearshift lever to 1st (on a uphill) or "R" (Reverse) (on a downhill) position, for vehicles with a manual transaxle, set the selector lever {continuously variable transmission (CVT)} or the gearshift lever (Twin Clutch SST) to "P" (PARK) position for vehicles with CVT or Twin Clutch SST.

Parking brake

To apply

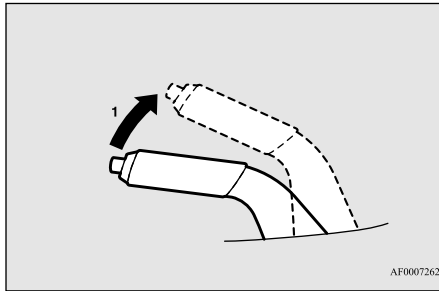

- 1- Pull the lever up without pushing the button at the end of hand grip. When the parking brake is set and the ignition switch is in the "ON" position, the brake warning light in the instrument cluster will come on.

Before driving, be sure to release the parking brake.

To release

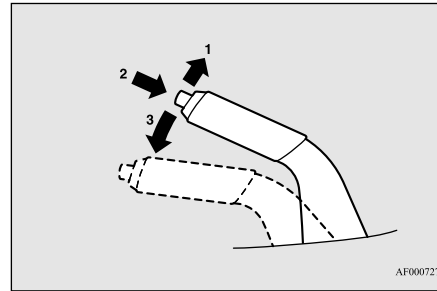

- 1- Pull the lever up slightly.
- 2- Push and hold the button at the end of the hand grip.
- 3- Push the lever downward.

When parking on a hill, apply the parking brake and turn the front wheels toward the curb on a downhill grade, away from the curb on an uphill grade.

CAUTION

- Before driving, be sure that the parking brake is fully released and brake warning light is off. If you drive without the parking brake fully released, the warning display will appear on the information screen in the multi-information display. If a vehicle is driven without releasing the parking brake, the brakes will be overheated, resulting in ineffective braking and possible brake failure.

Warning light



Warning display type 1



Warning display type 2



5

Steering wheel tilt lock lever

Steering wheel tilt lock lever

N00511500215

To adjust the steering wheel height, release the tilt lock lever while holding the steering wheel by hand, and raise or lower the steering wheel to the desired height.

5

After adjustment, securely lock the lever by pulling it upward.

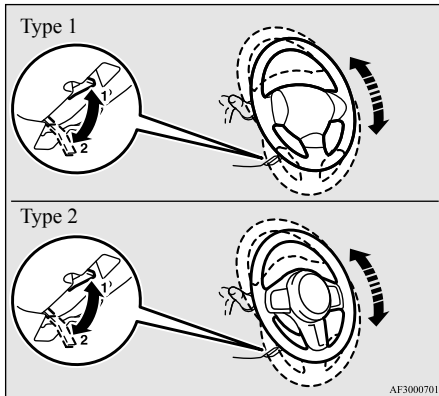

- 1- Locked
- 2- Released

WARNING

- After adjusting, make sure the lock lever is secured in the locked (1) position.

WARNING

- Do not attempt to adjust the steering wheel while driving. This can be dangerous.
- When releasing the tilt lock lever {moving it to the position (2)}, be sure to hold the steering wheel firmly. Otherwise, the steering wheel may slip down too suddenly.

Inside day/night rearview mirror

N00548601080

Adjust the inside rearview mirror only after making any seat adjustments so as to have a clear view to the rear of the vehicle.

WARNING

- Do not attempt to adjust the inside rearview mirror while driving. This can be dangerous. Be sure to adjust the mirror before driving.

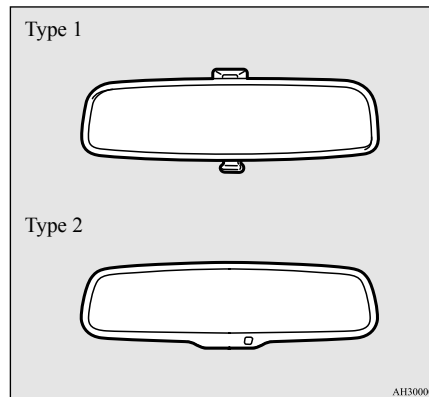

Adjust the inside mirror to maximize the view through the rear window.

Inside day/night rearview mirror

To adjust the vertical mirror position

It is possible to move the mirror up and down to adjust its position.

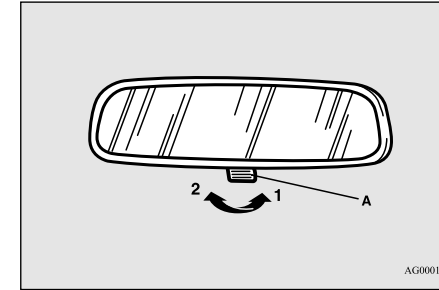
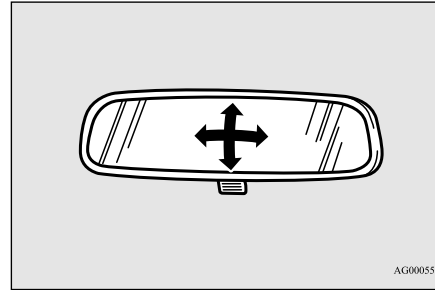
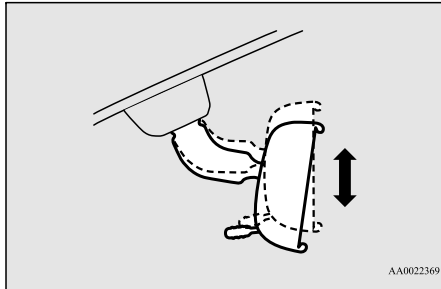

5

- 1- Daytime position
- 2- Night position

To reduce the glare

Type 1

The day/night knob (A) at the bottom of the mirror can be used to adjust the mirror to reduce the glare from the headlights of vehicles behind you during night driving.

To adjust the mirror position

It is possible to move the mirror up/down and left/right to adjust its position.

Outside rearview mirrors

Type 2

When the headlights of the vehicles behind you are very bright, the reflection factor of the rearview mirror is automatically changed to reduce the glare.

5

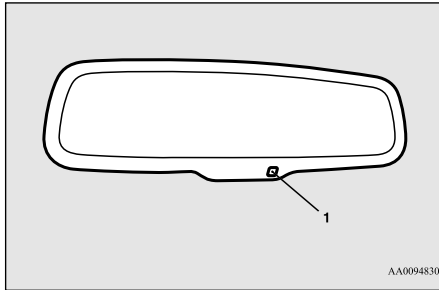

Normally, use the automatic mode. When the ignition switch is turned to the “ON” position, the reflection factor of the mirror is automatically changed.

NOTE

- Do not hang items on, or spray glass cleaner on the sensor (1), as reduced sensitivity could result.

Outside rearview mirrors

N00512201245

Adjust the outside rearview mirrors only after making any seat adjustments so you have a clear view to the rear of the vehicle.

WARNING

- Do not attempt to adjust the outside rearview mirrors while driving. This can be dangerous. Be sure to adjust the mirrors before driving.
- Your passenger’s side mirror is convex. The objects you see in the mirror will look smaller and farther away than they appear in a regular flat mirror. Do not use this mirror to estimate the distance of vehicles following you when changing lanes.

To adjust the mirror position

The outside rearview mirrors can be adjusted when the ignition switch is in the “ON” or “ACC” position. Move the lever (A) to the same side as the mirror you wish to adjust.

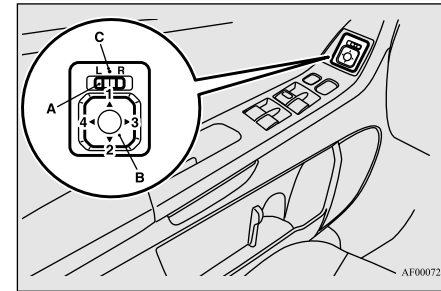

L- Left outside mirror adjustment
R- Right outside mirror adjustment

Press the switch (B) to adjust the mirror position.

- 1- Up
- 2- Down
- 3- Right
- 4- Left

NOTE

- After adjusting, return the lever to the “•” (off) position (C).

To fold the mirror

The outside mirror can be folded in toward the side window to prevent damage when parking in tight locations.

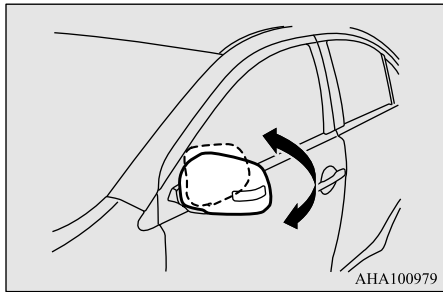

Heated mirror (if so equipped)

N00549300175

When the rear window defogger switch is pressed with the engine running, the outside rearview mirrors are defogged or defrosted. Current will flow through the heater element inside the mirrors, thus clearing away frost or condensation.

The indicator light (A) will illuminate while the defogger is on. The heater will be turned off automatically in about 20 minutes.

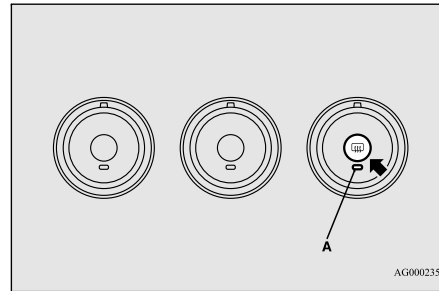

Ignition switch

N00512400615

[For vehicles equipped with the F.A.S.T.-key]
For information on operations for vehicles equipped with the F.A.S.T.-key, refer to “F.A.S.T.-key: Ignition switch” on page 5-16.

[Except for vehicles equipped with the F.A.S.T.-key]

Ignition switch

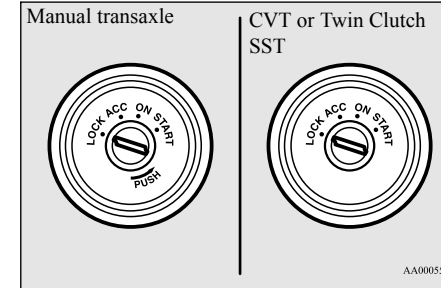

5

LOCK

The engine is off and the steering wheel is locked. The key can be inserted and removed only when the switch is in this position.

ACC

Allows operation of electrical accessories with the engine off.

ON

The engine runs and all accessories can be used.

Ignition switch

START

Engages the starter. After the engine starts, release the key and it will return automatically to the “ON” position.

5

NOTE

- Your vehicle is equipped with an electronic immobilizer. To start the engine, the ID code which the transponder inside the key sends must match the one registered to the immobilizer computer. (Refer to “Electronic immobilizer” on page 5-4.)

ACC power auto-cutout function

N00539601097

After about 30 minutes has elapsed with the ignition switch in the “ACC” position, the function automatically cuts out the power for the audio system and other electric devices that can be operated with that position.

When the ignition switch is turned from the “ACC” position, the power is supplied again to those devices.

NOTE

- It is possible to modify functions as follows:

5-54 Features and controls

NOTE

- The time until the power cuts out can be changed to about 60 minutes.
 - The ACC power auto-cutout function can be deactivated.
- For details, consult a Mitsubishi Motors dealer.

To remove the key

N00550900184

For vehicles with a manual transaxle, when removing the key, push the key in at the “ACC” position and keep it depressed until it is turned to the “LOCK” position, and remove.

Manual transaxle

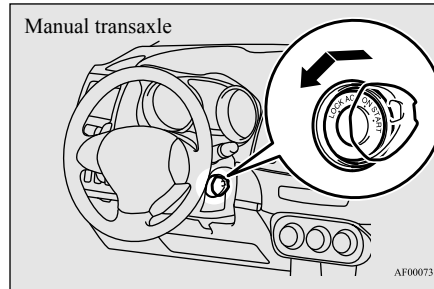

For vehicles with a continuously variable transmission (CVT) or Twin Clutch SST, when removing the key, first set the selector lever (CVT) or the gearshift lever (Twin

Clutch SST) to the “P” (PARK) position, and then turn the key to the “LOCK” position and remove it.

CVT or Twin Clutch SST

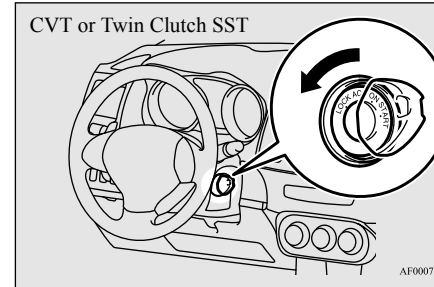

NOTE

- For vehicles with a CVT or Twin Clutch SST, the key cannot be removed unless the selector lever (CVT) or the gearshift lever (Twin Clutch SST) is set to the “P” (PARK) position, which allows the ignition switch to turn to the “LOCK” position.

CAUTION

- Do not remove the ignition key from the ignition switch while driving. The steering wheel will lock, causing loss of control.

Steering wheel lock

⚠ CAUTION

- If the engine is turned off while driving, the power brake booster will stop functioning and braking efficiency will be reduced. Also, the power steering system will not function and it will require greater effort to manually steer the vehicle.
- Do not leave the key in the “ON” position for a long time when the engine is not running. This will cause the battery to run down.
- Do not turn the key to the “START” position when the engine is running. It will damage the starter motor.

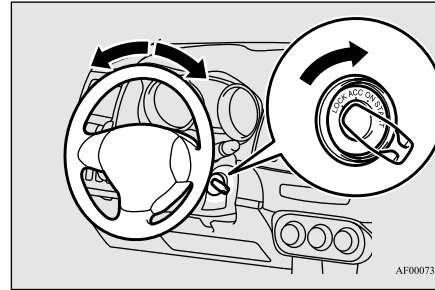

📖 NOTE

- If the front wheels are turned, the anti-theft lock may sometimes make it difficult to turn the key from “LOCK” position to “ACC” position. Firmly turn the steering wheel to the left or to the right as you turn the key.

Steering wheel lock

N00512500195

[For vehicles equipped with the F.A.S.T.-key]
For information on operations for vehicles equipped with the F.A.S.T.-key, refer to “F.A.S.T.-key: Steering wheel lock” on page 5-20.

[Except for vehicles equipped with the F.A.S.T.-key]

To lock

Remove the key at the “LOCK” position.
Turn the steering wheel until it is locked.

To unlock

Turn the key to the “ACC” position while moving the steering wheel slightly.

⚠ CAUTION

- Remove the key when leaving the vehicle.

Starting and stopping the engine

N00542100060

Tips for starting

- Do not operate the starter motor continuously for longer than 15 seconds as this could run the battery down or damage the starter motor. If the engine does not start, turn the ignition switch back to the “LOCK” position, wait a few seconds, and then try again. Trying repeatedly with the engine or starter motor still turning will damage the starter mechanism.
- If the engine will not start because the battery is weak or discharged, refer to “Jump-starting the engine” (on page 8-2) for instructions.
- [Except for vehicles equipped with the turbocharger]

Starting and stopping the engine

5

The engine is warmed up enough for driving when the bar graph of engine coolant temperature display starts to move. A longer warm up period will only consume extra fuel.

- [For vehicles equipped with the turbo-charger]

The engine is warmed up enough for driving when the bar graph of engine coolant temperature display starts to move. Driving before the bar graph moves may cause deterioration of turbocharger performance and driveability. A longer warm up period will only consume extra fuel.

- On vehicles equipped with the Twin Clutch SST, the following may occur after the engine is started, but they do not indicate an abnormality.

- You may hear operational sounds of the Twin Clutch SST and you may feel vibration in the vehicle body.
- If you shift the gearshift lever into the “N” (NEUTRAL) position and depress the accelerator pedal, increases in the engine speed will be limited.

⚠ WARNING

- **Never run the engine in a closed or poorly ventilated area any longer than is needed to move your vehicle out of the area. Carbon monoxide gas, which is odorless and extremely poisonous, could build up and cause serious injury or death.**

⚠ CAUTION

- Do not push-start the vehicle.
- Do not run the engine at high rpms or drive at high speeds until the engine has had a chance to warm up.
- Release the ignition switch as soon as the engine starts. Otherwise, the starter motor will be damaged.

Starting the engine

N00542201169

[For vehicles equipped with the F.A.S.T.-key.]

For information on operation for vehicles equipped with the F.A.S.T.-key, refer to “F.A.S.T.-key: Starting the engine” on page 5-20.

[Except for vehicles equipped with the F.A.S.T.-key.]

Your vehicle is equipped with an electronically controlled fuel injection system, which automatically controls the release of fuel.

There is usually no need to depress the accelerator pedal when starting the engine.

The starter should not be run for more than 15seconds at a time.

To prevent battery drain, wait a few seconds between attempts to restart the engine.

1. Make sure all occupants are properly seated with seat belts fastened
2. Insert the ignition key.
3. Make sure the parking brake is applied.
4. Press and hold the brake pedal down with your right foot.
5. Press and hold the clutch pedal all the way down (manual transaxle).

📖 NOTE

- For models equipped with a manual transaxle, the starter will not operate unless the clutch pedal is fully depressed (Clutch interlock). This is a safety feature.

6. On vehicles with manual transaxle, place the gearshift lever in the “N” (Neutral) position.

On vehicles with continuously variable transmission (CVT) or Twin Clutch SST, make sure the selector lever (CVT) or gearshift lever (Twin Clutch SST) is in the “P” (PARK) position.

Starting and stopping the engine

NOTE

- On vehicles with CVT, the starter will not operate unless the selector lever is in the “P” (PARK) or “N” (NEUTRAL) position. On vehicles with Twin Clutch SST, the starter will not operate unless the gearshift lever is in the “P” (PARK) position or the gearshift lever is in the “N” (NEUTRAL) position with the brake pedal depressed. For safety reasons, start the engine in the “P” (PARK) position so that the wheels are locked.

7. Turn the ignition switch to the “ON” position and make certain that all warning lights are functioning properly before starting the engine.
8. Turn the ignition switch to the “START” position without pressing the accelerator pedal. Release the key when the engine starts.

NOTE

- Minor noises may be heard on engine start-up. These will disappear as the engine warms up.

When the engine is hard to start

After several attempts, you may experience that the engine still does not start.

1. Make sure that all electric devices, such as lights, air conditioning blower and rear window defogger, are turned off.
2. While depressing the brake pedal on vehicles equipped with continuously variable transmission (CVT) or Twin Clutch SST or the clutch pedal on the vehicles equipped with manual transaxle, press the accelerator pedal halfway and hold it there, then crank the engine. Release the accelerator pedal, immediately after the engine starts.
3. If the engine still will not start, the engine could be flooded with too much gasoline. While depressing the brake pedal on vehicles equipped with CVT or Twin Clutch SST or the clutch pedal on the vehicles equipped with manual transaxle, push the accelerator pedal all the way down and hold it there, then crank the engine for 5 to 6 seconds. Return the ignition switch to the “LOCK” position and release the accelerator pedal. Wait a few seconds, and then crank the engine again for 5 to 6 seconds while depressing the brake pedal or the clutch pedal, but do not push the accelerator pedal. Release the ignition key if the engine starts. If the engine fails to start, repeat these procedures. If the engine still will not start, contact your local Mitsubishi Motors dealer or a repair facility of your choice for assistance.

Startability of continuously variable transmission (CVT) vehicles or Twin Clutch SST vehicles at extremely cold ambient temperature

When the ambient temperature is -4°F (-20°C) or lower on vehicles with CVT, or -22°F (-30°C) or lower on vehicles with Twin Clutch SST, it may not be possible to start from a standstill even with the selector lever (CVT) or the gearshift lever (Twin Clutch SST) in the “D” (DRIVE) or “R” (REVERSE) position.

This phenomenon occurs because the transaxle has not warmed up sufficiently; it does not indicate a problem. If it occurs, place the selector lever (CVT) or the gearshift lever (Twin Clutch SST) in the “P” (PARK) position and let the engine idle for at least 10 minutes.

The transaxle will warm up, and you will be able to start normally.

Do not leave the vehicle during warm-up operation.

Idle speed in high altitude area

N00547600015

At high altitude locations, the idle speed may be higher. This is done in order to stabilize

5

Starting and stopping the engine

the idle speed when the power steering system and other systems operate. It does not indicate a malfunction.

Stopping the engine

N0054230088

5

1. Bring the vehicle to a complete stop.
2. Fully engage the parking brake while depressing the brake pedal.
3. For vehicles with a manual transaxle, turn the ignition switch to the "LOCK" position to stop the engine, and then move the gearshift lever to the 1st (on a uphill) or "R" (Reverse) (on a downhill) position. For vehicles with continuously variable transmission (CVT) or Twin Clutch SST, place the selector lever (CVT) or the gearshift lever (Twin Clutch SST) in the "P" (PARK) position, and then turn the ignition switch to the "LOCK" position to stop the engine.

NOTE

- For vehicles with Twin Clutch SST, the engine will stop and the vehicle power will turn off approximately 1 second after the ignition switch is turned to the "LOCK" position.

The reason for this is that, in the time from when the ignition switch is turned to the "LOCK" position until the engine stops, the gears inside the Twin Clutch SST disengage so that the engine will start smoothly the next time it is started.

Two clutches installed in the Twin Clutch SST alternately engage and disengage to achieve smooth shifting.

In addition, the gear on the side with the free clutch is engaged, therefore, quick shifting is performed.

If the engine was stopped with the gear engaged like this, it would provide resistance the next time the engine is started. Therefore, the gear disengages in the approximately 1-second period until the engine stops.

- For vehicles with Twin Clutch SST, do not operate the gearshift lever or the accelerator pedal for approximately 1 second until the engine stops.

NOTE

- For vehicles with Twin Clutch SST, if the temperature inside the engine compartment is high, the cooling fans (A) will continue to operate for some time even if the engine is stopped.

Therefore, the operation sound of the cooling fans may be heard even after the engine is stopped. This sound is normal and does not indicate a malfunction.

After operating for a period of time, the cooling fans will stop automatically.

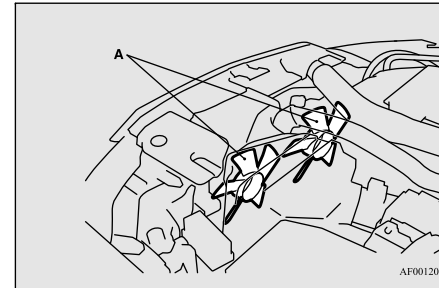

Turbocharger operation (if so equipped)

N00537300051

CAUTION

- Do not run the engine at high speeds (for example, by revving it or by accelerating rapidly) immediately after starting it.
- Do not stop the engine immediately after high-speed or uphill driving. First allow the engine to idle to give the turbocharger a chance to cool down.
- Engine oil must be properly maintained to avoid engine and/or turbocharger damage. To better protect your engine and turbocharger, use fully synthetic engine oil.

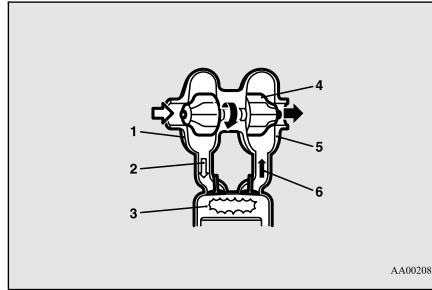

AA0020860

- 1- Air compressor
- 2- Compressed air
- 3- Cylinder
- 4- Turbo fin
- 5- Turbine
- 6- Exhaust gas

Turbocharger operation (if so equipped)

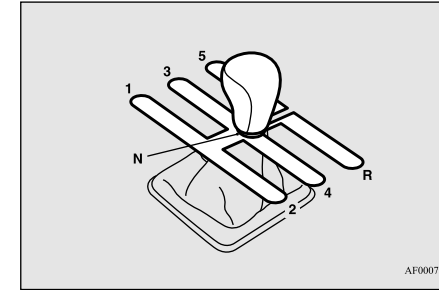

AF0007347

5

NOTE

- During cold weather, shifting may be difficult until the transaxle lubricant has warmed up. This is normal and not harmful to the transaxle.

Turbocharger

The turbocharger increases engine power by pushing large amounts of air into the engine's cylinders. The finned parts inside the turbocharger turn at extremely high speeds and are subjected to extremely high temperatures. They are lubricated by engine oil and cooled by engine oil and coolant. If the engine oil is not replaced at the specified intervals, the bearings may seize or emit abnormal noise.

Manual transaxle (if so equipped)

N00512700113

The shift pattern below is shown on the gearshift lever. Press the clutch pedal all the way down while shifting gears.

To start

Press the clutch pedal all the way down and shift into 1st or "R" (Reverse) position. Then gradually release the clutch pedal while depressing the accelerator pedal.

CAUTION

- Do not move the gearshift lever into reverse while the vehicle is moving forward; doing so will damage the transaxle.

Manual transaxle (if so equipped)

⚠ CAUTION

- Do not rest your foot on the clutch pedal because this will cause premature clutch wear or damage.
- Do not coast in the “N” (Neutral) position (illegal in many states).
- Do not use the gearshift lever as a handrest, because this can result in premature wear of the transaxle shift forks.

📖 NOTE

- If it is hard to shift into 1st, depress the clutch pedal a second time; the shift will then be easier.
- To shift into reverse from 5th gear, move the gearshift lever to the “N” (Neutral) position, and then shift it into reverse.

Proper shift points

N00537400049

Always use care to change the gear with the vehicle speed matched to the engine speed. Proper shifting will improve fuel economy and prolong engine life.

⚠ CAUTION

- Avoid downshifting that may cause the tachometer pointer to enter the red zone. This puts the engine at risk of being damaged.

5-60 Features and controls

Changing gears while the vehicle is moving

N00548101027

Always use care to change the gear with the vehicle speed matched to the engine speed. Proper shifting will improve fuel economy and prolong engine life. Avoid shifting down at high speed, as this may cause excessive engine speed (the tachometer needle into the red zone) and damage the engine.

📖 NOTE

- The gearshift indicator shows recommended gearshift points for fuel-efficient driving. It shows a “▲” when an upshift is recommended, and it shows a “▼” when a downshift is recommended.

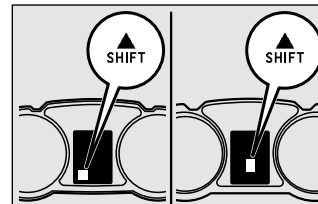

AHZ100248

Upshifting

N00512900131

For the best fuel economy and performance in using your manual transaxle, upshift as listed below.

At low altitude locations, shift at the vehicle speeds listed. Upshifting earlier during cruise conditions (relatively steady speeds) will improve your fuel economy.

Shift point	Upshift speeds	
	Acceleration	Cruise
1st gear to 2nd gear	15 mph (24 km/h)	15 mph (24 km/h)
2nd gear to 3rd gear	28 mph (45 km/h)	19 mph (31 km/h)
3rd gear to 4th gear	36 mph (58 km/h)	33 mph (53 km/h)
4th gear to 5th gear	45 mph (72 km/h)	45 mph (72 km/h)

At high altitude locations, upshift as listed below.

Shift point	Upshift speeds
1st gear to 2nd gear	15 mph (24 km/h)
2nd gear to 3rd gear	25 mph (40 km/h)
3rd gear to 4th gear	40 mph (64 km/h)

Continuously variable transmission (CVT) (if so equipped)

Shift point	Upshift speeds
4th gear to 5th gear	45 mph (72 km/h)

Downshifting

N0051300096

It is recommended that you downshift to a lower gear when needed to maintain the desired speed, according to the table.

Avoid downshifting at too high a speed. The engine may suffer damage.

To maintain a safe speed and prolong brake life, shift down to 2nd or 1st when descending a steep hill.

Downshifting is also important to avoid “lugging” the engine at too low a speed, such as when turning a corner or when driving up a steep hill.

Recommended downshifting speed

Downshifting speed	Shift point
Under 20 mph (32 km/h)	Shift down from current gear to 2nd gear.
20 to 30 mph (32 to 48 km/h)	Shift down from current gear to 3rd gear.

Driving precautions

N00513100215

The table below shows the maximum recommended driving speed for in each gear. Do not drive near or at these speeds for prolonged periods of time.

Maximum possible driving speed

Shift points	Maximum possible driving speed
1st gear	31 mph (50 km/h)
2nd gear	62 mph (100 km/h)
3rd gear	87 mph (140 km/h)
4th gear	121 mph (195 km/h)

Do not use the gearshift lever as a handrest. This can result in premature wear of the transaxle shift forks.

Continuously variable transmission (CVT) (if so equipped)

N00513200229

The CVT will automatically and continuously change its gear ratio depending on road and

driving conditions. This helps achieve smooth driving and excellent fuel efficiency. Also you can manually shift up and shift down the transmission. Refer to “Sports mode” on page 5-66.

DRIVING UPHILL

5

The transmission prevents unnecessary upshifts even when the accelerator pedal is released and ensures smooth driving.

DRIVING DOWNHILL

According to the conditions, the transmission will automatically shift to a lower gear ratio to achieve stronger engine braking. This may help reduce your need to use the service brake.

Selector lever operation

N00513800384

As an additional safety precaution, models equipped with a continuously variable transmission have a shift-lock device that holds the selector lever in the “P” (PARK) position. To move the selector lever from the “P” (PARK) position to another position, follow the steps below.

Continuously variable transmission (CVT) (if so equipped)

1. Press and hold the brake pedal down.
2. Move the selector lever to the desired position.

NOTE

- The selector lever cannot be moved from “P” (PARK) to another position if the ignition switch is at the “LOCK” or “ACC” position, or the key has been removed, or if the brake pedal is not pressed and held down.

5

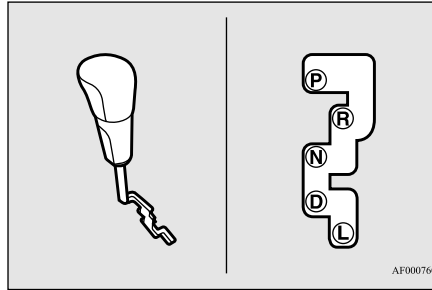

WARNING

- Always depress the brake pedal when shifting the selector lever into a selector position from the “P” (PARK) or “N” (NEUTRAL) position.
- When beginning to drive, do not shift the selector lever from the “P” (PARK) or “N” (NEUTRAL) position while depressing the accelerator pedal. Doing so is dangerous because the vehicle will “jump” forward or backward.

Except for vehicles with manual gate

The CVT has 2 forward selector positions and 1 reverse selector position.

The CVT selects an optimum ratio automatically when the selector lever is in the “D” (DRIVE) or “L” (LOW) position, depending on the speed of the vehicle and the position of the accelerator pedal.

The selector lever has 5 positions.

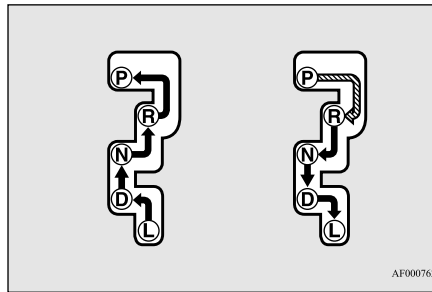

	With the brake pedal depressed, set the selector lever in the gate to operate.
	Set the selector lever in the gate to operate.

NOTE

- To ensure proper transmission operation, stop at each detent position when shifting. After shifting, check the position in the multi-information display.
- If the brake pedal is not depressed and held, the shift-lock device activates to prevent the selector lever from being moved from the “P” (PARK) position.
- For a shift indicated by in the illustration, depress the brake pedal before moving the selector lever. If you attempt to move the selector lever before depressing the brake pedal, the selector lever will be immovable.

Vehicles with manual gate

The CVT has 2 forward selector positions and 1 reverse selector position.

Continuously variable transmission (CVT) (if so equipped)

The CVT selects an optimum ratio automatically when the selector lever is in the “D” (DRIVE) position, depending on the speed of the vehicle and the position of the accelerator pedal.

The selector lever (A) has 2 gates; the main gate (B) and the manual gate (C).

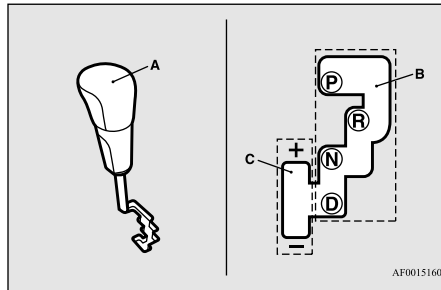

NOTE

- In the main gate, the selector lever has 4 positions.
- For information on manual gate operation, please refer to “Sports mode” on page 5-66.

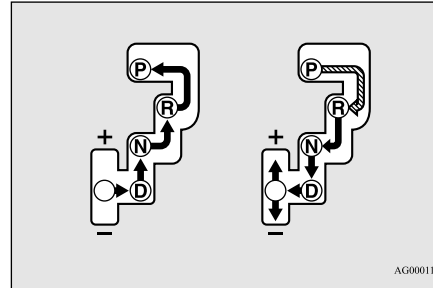

	With the brake pedal depressed, set the selector lever in the gate to operate.
	Set the selector lever in the gate to operate.

WARNING

- **Always depress the brake pedal when shifting the selector lever into a selector position from the “P” (PARK) or “N” (NEUTRAL) position. When beginning to drive, do not shift the selector lever from the “P” (PARK) or “N” (NEUTRAL) position while depressing the accelerator pedal. Doing so is dangerous because the vehicle will “jump” forward or backward.**

NOTE

- To ensure proper transmission operation, stop at each detent position when shifting. After shifting, check the position in the multi-information display.
- If the brake pedal is not depressed and held, the shift-lock device activates to prevent the selector lever from being moved from the “P” (PARK) position.
- For a shift indicated by in the illustration, depress the brake pedal before moving the selector lever. If you attempt to move the selector lever before depressing the brake pedal, the selector lever will be immovable.

5

When the selector lever cannot be shifted from the “P” (PARK) position

N00563100021

When the selector lever cannot be shifted from the “P” (PARK) position to another position while the brake pedal is pressed and held down with the ignition switch at the “ON” position, the battery may be flat or the shift-lock mechanism may be malfunctioning.

Immediately have your vehicle checked by an authorized Mitsubishi Motors dealer or a repair facility of your choice.

If you need to move the vehicle, shift the selector lever as follows.

Continuously variable transmission (CVT) (if so equipped)

1. Make sure the parking brake is fully applied.
2. Stop the engine if it is running.
3. Insert a screwdriver with a cloth over its tip into the notch (A) of the cover. Pry gently as shown to remove the cover.

5

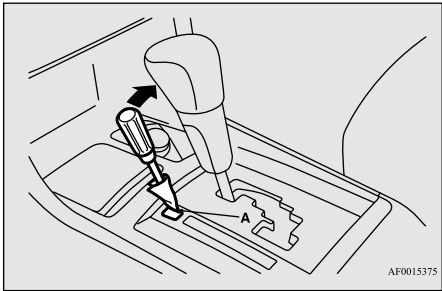

4. Depress the brake pedal with the right foot.
5. Turn the ignition switch to the “ACC” position.

NOTE

- For vehicles with the Free-hand Advanced Security Transmitter (F.A.S.T.-key), turn the ignition switch to the “ACC” position with the emergency key if the vehicle battery is flat.

6. Insert a screwdriver in the shift-lock release hole (B). Shift the selector lever to the “N” (NEUTRAL) position while pressing the screwdriver down.

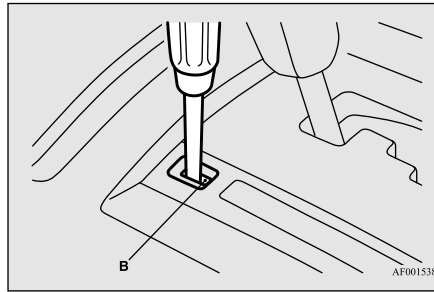

Selector lever position display

N00513900402

When the ignition switch is turned to the “ON” position, the selector lever position is shown on the multi-information display.

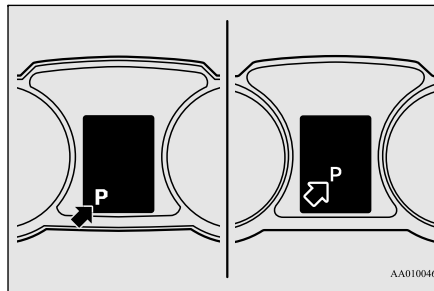

Warning display

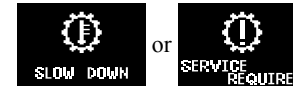

N00514000194

Type 1





Type 2



When the  warning display or the  warning display appears on the information screen in the multi-information display while you are driving, there could be a malfunction in the CVT.

CAUTION

- If a malfunction occurs in the CVT while driving, the  warning display or the  warning display will appear on the information screen in the multi-information display. In this case, immediately park your vehicle in a safe place and follow these procedures:

[When  warning display is showing]

The continuously variable transmission (CVT) fluid is overheating. The engine control may activate to lower the CVT fluid temperature, causing the engine revolutions and vehicle speed to decrease. In this case, take one of the following procedures:

Continuously variable transmission (CVT) (if so equipped)

CAUTION

- Slow down your vehicle.
- Stop your vehicle in a safe place, put the selector lever in the “P” (PARK) position, and open the engine hood with the engine running to allow the engine to cool down.

After a while, confirm that the  warning display is no longer showing. It is safe to continue driving if the display is no longer showing. If the warning display remains or flashes frequently, have your vehicle inspected by an authorized Mitsubishi Motors dealer or a repair facility of your choice.

[When  warning display is showing]

It may be that there is something unusual happening in the CVT, causing a safety device to activate. Have your vehicle inspected by an authorized Mitsubishi Motors dealer or a repair facility of your choice as soon as possible.

Selector lever positions

N00514200372

“P” PARK

This position locks the transmission to prevent the vehicle from moving. The engine can be started from the “PARK” position.

“R” REVERSE

Move the lever to this position only after the vehicle has come to a complete stop.

CAUTION

- Never shift into the “P” (PARK) or “R” (REVERSE) position while the vehicle is in motion. If the lever is shifted into the “P” (PARK) or “R” (REVERSE) position while the vehicle is in motion, the transmission may be damaged.

“N” NEUTRAL

At this position, the transmission is disengaged. It is the same as the neutral position on a manual transaxle and should be used when the vehicle is not moving for an extended length of time during driving, such as in a traffic jam.

WARNING

- Never move the selector lever to the “N” (NEUTRAL) position while driving since you could accidentally slip it into the “P” (PARK) or “R” (REVERSE) position, damaging the transmission.

WARNING

- To prevent the vehicle from rolling when stopped on a slope, the engine should be started in the “P” (PARK) position, not in “N” (NEUTRAL) position.
- To prevent rolling, always keep your foot on the brake pedal when the vehicle is in “N” (NEUTRAL) position, or when shifting into or out of “N” (NEUTRAL) position.

5

“D” DRIVE

This position is used for most city and highway driving. The transmission will automatically and continuously change its gear ratio depending on road and driving conditions.

CAUTION

- To prevent transmission damage, never shift into the “D” (DRIVE) position from the “R” (REVERSE) position while the vehicle is in motion.

“L” LOW (except for vehicles with manual gate)

This position is for driving up very steep hills and for engine braking at low speeds when driving down steep hills.

Continuously variable transmission (CVT) (if so equipped)

⚠ WARNING

- This position can be used for maximum engine braking. Be very careful not to shift into “L” (LOW) suddenly. Sudden engine braking may cause the tires to skid. Select this position according to the road conditions and vehicle speed.

5

Sports mode (if so equipped)

N00514400417

Vehicles with manual gate

Whether the vehicle is stationary or in motion, sports mode is selected by pushing the selector lever from the “D” (DRIVE) position into the manual gate (1). To return to “D” (DRIVE) operation, push the selector lever back into the main gate (2).

In sports mode, rapid shifting is possible simply by operating the selector lever or sportronic steering wheel paddle shifter.

Unlike the manual transaxle, sports mode allows shifting with the accelerator pedal depressed.

📖 NOTE

- For vehicles equipped with the sportronic steering wheel paddle shifter, sports mode can be operated even when the selector lever is in the main gate (2). To return to “D” (DRIVE) operation, pull the sportronic steering wheel paddle shifter on the +(UP) side for longer than 2 seconds, or park the vehicle to change the selector lever position indicator to “D” (DRIVE) and return to “D” (DRIVE) operation.

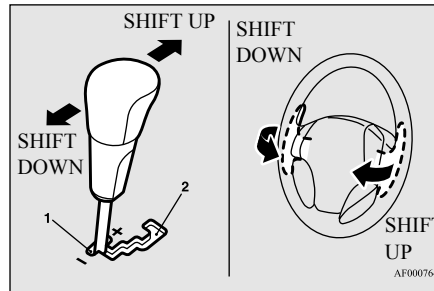

+ (SHIFT UP)
Transmission shifts up once by each operation.

- (SHIFT DOWN)
Transmission shifts down once by each operation.

⚠ CAUTION

- Upward shifts do not take place automatically in sports mode. The driver must make upward shifts in accordance with prevailing road conditions, making sure the engine rpm remains below the red zone on the tachometer.
- By rapidly moving the selector lever or sportronic steering wheel paddle shifter to the “- (SHIFT DOWN)” side twice, it is possible to skip one shift range (i.e., 3rd to 1st or 4th to 2nd). Since sudden engine braking or acceleration can cause a loss of traction, downshifts must be made carefully in accordance with the vehicle’s speed.
- On vehicles with a sportronic steering wheel paddle shifter, shift ranges may not change when the lateral paddle shifters are operated at the same time.

📖 NOTE

- Shift ranges can only be selected in a forward direction from 1st to 6th. To reverse or park the vehicle, move the selector lever to the “R” or “P” position.

Continuously variable transmission (CVT) (if so equipped)

NOTE

- To maintain good running performance, the transmission may refuse to perform an upshift when the selector lever or sportronic steering wheel paddle shifter is moved to the “+(SHIFT UP)” position at certain vehicle speeds. Also, to prevent over-revving of the engine, the transmission may refuse to perform a downshift when the shift lever or sportronic steering wheel paddle shifter is moved to the “- (SHIFT DOWN)” position at certain vehicle speeds. When this happens, a buzzer sounds to indicate that a downshift is not going to take place.
- Move the selector lever gently between the manual and main gates and between positions in the manual gate. And do not operate sportronic steering wheel paddle shifter violently. Excessive force could damage the selector lever or sportronic steering wheel paddle shifter.

Except for vehicles with manual gate

While driving with the selector lever in the “D” (DRIVE), sports mode can be selected by pulling one of the sportronic steering wheel shifters toward you. In sports mode, rapid shifting is possible simply by operating the sportronic steering wheel paddle shifter.

Unlike the manual transaxle, sports mode allows shifting with the accelerator pedal depressed.

NOTE

- To return to “D” (DRIVE) operation, pull the sportronic steering wheel paddle shifter on the +(UP) side for longer than 2 seconds, or park the vehicle to change the selector lever position indicator to “D” (DRIVE) and return to “D” (DRIVE) operation.
- When the sportronic steering wheel paddle shifter is operated with the selector lever in the “L” (LOW) position, gear is not shifted because the selectable shift range is limited.

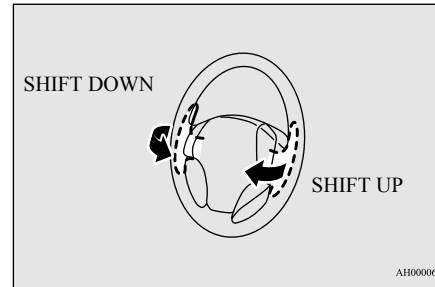

+ (SHIFT UP)

Transmission shifts up once by each operation.

- (SHIFT DOWN)

Transmission shifts down once by each operation.

CAUTION

- Upward shifts do not take place automatically in sports mode. The driver must make upward shifts in accordance with prevailing road conditions, making sure the engine rpm remains below the red zone on the tachometer.
- By rapidly moving the sportronic steering wheel paddle shifter to the “- (SHIFT DOWN)” side twice, it is possible to skip one shift range (i.e., 3rd to 1st or 4th to 2nd). Since sudden engine braking or acceleration can cause a loss of traction, downshifts must be made carefully in accordance with the vehicle’s speed.
- Shift ranges may not change when the lateral paddle shifters are operated at the same time.

NOTE

- Shift ranges can only be selected in a forward direction from 1st to 6th. To reverse or park the vehicle, move the selector lever to the “R” or “P” position.

Continuously variable transmission (CVT) (if so equipped)

NOTE

- To maintain good running performance, the transmission may refuse to perform an upshift when the sportronic steering wheel paddle shifter is moved to the “+(SHIFT UP)” position at certain vehicle speeds. Also, to prevent over-revving of the engine, the transmission may refuse to perform a downshift when the sportronic steering wheel paddle shifter is moved to the “-(SHIFT DOWN)” position at certain vehicle speeds. When this happens, a buzzer sounds to indicate that a downshift is not going to take place.
- Do not operate sportronic steering wheel paddle shifter violently. Excessive force could damage the sportronic steering wheel paddle shifter.

Sports mode display

N00538800154

In sports mode, the currently selected shift range is displayed on the information screen in the multi-information display.

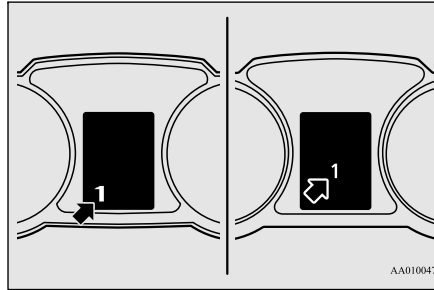

AA0100474

NOTE

- While driving in sports mode, the sports mode display may change to show “D” and shifting in sports mode may no longer be possible. This indicates that controls to drive in the “D” position are operating normally in order to lower the temperature of the continuously variable transmission (CVT) fluid; it does not indicate a malfunction. Once the temperature of the continuously variable transmission (CVT) fluid drops, shifting in the sports mode will be possible again.

Operation of the CVT

N00514500287

CAUTION

- Before selecting a position with the engine running and the vehicle stationary, fully depress the brake pedal to prevent the vehicle from creeping. Do not release the brakes until you are ready to drive away. The vehicle will begin to move as soon as the CVT is engaged, especially when the engine speed is high (fast idle or air conditioning on).
- Depress the brake pedal with the right foot. Using the left foot could cause driver movement delay in case of an emergency.
- To prevent sudden acceleration, never run the engine at high rpms when shifting from the “P” (PARK) or “N” (NEUTRAL) position.
- Operating the accelerator pedal while the other foot is resting on the brake pedal will affect braking efficiency and may cause premature wear of brake pads.
- Use the selector lever in the correct shift position in accordance with driving conditions. Never coast downhill backward in the driving shift position { “D” (DRIVE), “L” (LOW) or sports mode } or coast forward in the “R” (REVERSE) position. Engine stopping and increased brake pedal and steering effort could lead to an accident.

Continuously variable transmission (CVT) (if so equipped)

CAUTION

- Do not rev the engine with the brake pedal pressed when the vehicle is stationary. This can damage the CVT.

Also, when you depress the accelerator pedal while holding down the brake pedal with the selector lever in the “D” (DRIVE) position, the engine revolutions may not rise as high as when performing the same operation with the selector lever in the “N” (NEUTRAL) position.

Passing acceleration

N00514900063

To gain extra acceleration in “D” (DRIVE) position (when passing another vehicle) push the accelerator to the floor if it is safe to do so in traffic conditions. The CVT will automatically downshift.

NOTE

- In sports mode, downshifts do not take place when the accelerator is depressed all the way to the floor.

Waiting

N00515000074

For short waiting periods, such as at traffic lights, the vehicle can be left in selector lever position and held stationary with the service brake.

For longer waiting periods with the engine running, the selector lever should be placed in the “N” (NEUTRAL) position.

CAUTION

- To avoid transmission overheating, never try to keep your vehicle stationary on a hill by using the accelerator pedal. Always apply the parking brake and/or service brake.
- Unexpected acceleration may occur if the selector lever is in a position other than “P” (PARK) or “N” (NEUTRAL). Before driving off from a stop, make sure that the selector lever is in “D” (DRIVE) position or “Sports mode” position.

Parking

N00515100062

To park the vehicle, first bring it to a complete stop, fully engage the parking brake, and then move the selector lever to the “P” (PARK) position.

If you are going to leave the vehicle unattended, always switch off the engine and carry the key.

NOTE

- On a slope, be sure to apply the parking brake before moving the selector lever to the “P” (PARK) position. If you move the selector lever to the “P” (PARK) position before applying the parking brake, it may be difficult to disengage the selector lever from the “P” (PARK) position when next you drive the vehicle, requiring application of a strong force to the selector lever to move from the “P” (PARK) position.

When the CVT makes no speed change

N00515300194

If the CVT does not shift while driving, or your vehicle does not pick up enough speed when starting on an uphill slope, there may be something unusual happening in the transmission, causing a safety device to activate. Have your vehicle checked at an authorized Mitsubishi Motors dealer or a repair facility of your choice as soon as possible.



- If your vehicle has difficulty moving uphill, shift the selector lever into “L” (LOW) position (except for vehicles with sport mode) or 2nd shift range of the sports mode.

This method might not work depending on the type of transmission malfunction.

Twin Clutch SST (Sportronic Shift Transmission) (if so equipped)

- Once the vehicle is moving on a level road, move the selector lever back to “D” (DRIVE) position.

NOTE

- When the  warning display or the  warning display appears on the information screen in the multi-information display, there could be a malfunction in the CVT. Refer to “Continuously variable transmission (CVT): Warning display” on page 5-64.

5

Twin Clutch SST (Sportronic Shift Transmission) (if so equipped)

N00539700059

The Twin Clutch SST is a transmission that, through integrated control of the engine and transmission, is able to achieve both the smooth shifting of an automatic transaxle and the acceleration and fuel economy close to a manual transaxle. In addition, the control mode can be selected from two types to suit the driving conditions.

Together with manual shifting, the transmission is capable of responding to a variety of driving circumstances.

Twin Clutch SST control mode → P.5-74

5-70 Features and controls

Manual shift → P.5-76

Gearshift lever operation

N00539800050

As an additional safety precaution, models equipped with a Twin Clutch SST have a shift-lock device that holds the gearshift lever in the “P” (PARK) position. To move the gearshift lever from the “P” (PARK) position to another position, follow the steps below.

- Press and hold the brake pedal down.
- Move the gearshift lever to the desired position.

NOTE

- The gearshift lever cannot be moved from “P” (PARK) to another position if the ignition switch is at the “LOCK” or “ACC” position, or the key has been removed, or if the brake pedal is not pressed and held down.

The Twin Clutch SST has 6 forward gears and 1 reverse gear.

The individual gears are selected automatically, depending on the position of the gearshift lever, the speed of the vehicle and the position of the accelerator pedal.

The gearshift lever (A) has 2 gates; the main shift gate (B) and the manual shift gate (C).

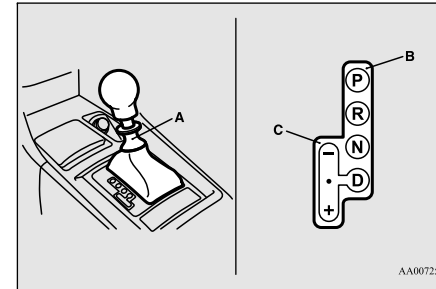

NOTE

- In the main shift gate, the gearshift lever has 4 positions.
- For information on manual shift gate operation, please refer to “Manual shift” on page 5-76.

Twin Clutch SST (Sportronic Shift Transmission) (if so equipped)

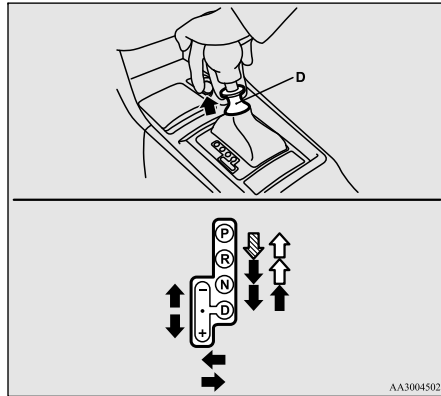

↙	The pull-ring (D) must be pulled up while the brake pedal is depressed to move the gearshift lever.
↓	The gearshift lever will move without pulling up the pull-ring (D).
↘	The pull-ring (D) must be pulled up to move the gearshift lever.

WARNING

- If the pull-ring is always pulled up when using the gearshift lever, the gearshift lever may be accidentally shifted into the “P” (PARK) or “R” (REVERSE) position. Do not pull up the pull-ring when making shifts shown by ↓ in the illustration.
- Always depress the brake pedal when shifting the gearshift lever into another position from the “P” (PARK) or “N” (NEUTRAL) position. When beginning to drive, do not shift the gearshift lever from the “P” (PARK) or “N” (NEUTRAL) position while depressing the accelerator pedal. Doing so is dangerous because the vehicle will “jump” forward or backward.

NOTE

- For a shift indicated by ↙ in the illustration, depress the brake pedal before moving the gearshift lever. If you attempt to move the gearshift lever before depressing the brake pedal, the gearshift lever will be immovable.
- Do not accelerate immediately after moving the gearshift lever. It may take some time for the transmission to shift to the selected gear.
- When the gearshift lever is operated when the Twin Clutch SST fluid temperature is low, the time required to shift to the selected gear may be longer than usual.

Gearshift lever position display

N0053990064

When the ignition switch is turned to the “ON” position, the gearshift lever position is shown on the multi-information display.

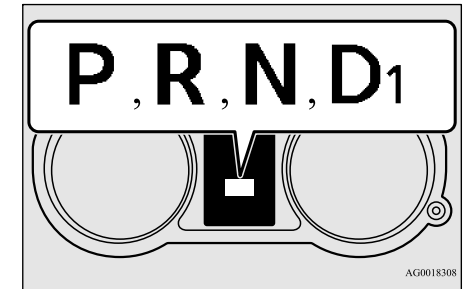

AG0018308

In addition, when the vehicle is driven with the gearshift lever in the “D” (DRIVE) position, the forward gear number is shown.

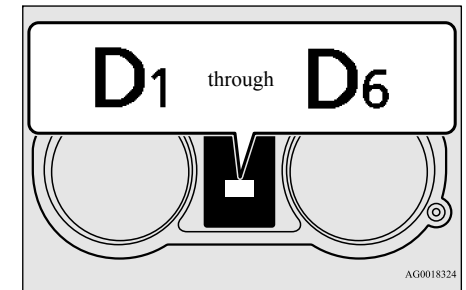

AG0018324

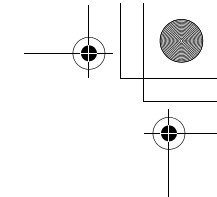

Twin Clutch SST (Sportronic Shift Transmission) (if so equipped)

When the gearshift lever position display blinks

5

When the gearshift lever is placed in the “R” (REVERSE) position, the gearshift lever position display on the multi-information display may blink and the vehicle will not move because the gears in the transmission have not engaged.

If this occurs, perform the following procedure.

1. Depress the brake pedal with your right foot and place the gearshift lever in the “N” (NEUTRAL) position.
2. Place the gearshift lever in the “R” (REVERSE) position, and confirm that the gearshift lever position display stops blinking.
3. Repeat 1 and 2 above if the gearshift lever position display continues to blink.

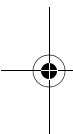

⚠ WARNING

- To avoid unintended vehicle movement, keep brake pedal applied with your right foot and do not depress the accelerator pedal, while the gearshift lever position display is blinking.

If the gearshift lever position display is not showing

N00562500028

There may be a problem in the Twin Clutch SST.

If this occurs, the safety device operates and prevents the vehicle from moving. Therefore, perform the following procedure.

1. Park your vehicle in a safe place and stop the engine.
2. Restart the engine.

If the gearshift lever position display is shown and the vehicle can move after this procedure is performed, there is no malfunction.

If the gearshift lever position display is not shown and the vehicle cannot move, or if this problem occurs repeatedly, have the vehicle checked by an authorized Mitsubishi Motors dealer or a repair facility of your choice as soon as possible.

Warning display

N00540000052



When the warning display or the warning display appears on the information screen in the multi-information display while you are driving, take the following measures.

When warning display is showing

N00543100096

The temperature of the Twin Clutch SST fluid is high.

If this occurs, take one of the following measures.

- Reduce the vehicle speed.
- Stop the vehicle in a safe place, place the gearshift lever in the “P” (PARK) position, and then open the engine hood with the engine running to cool the engine.

After a while, check that the warning display has gone out.

If the display goes out, the vehicle can be driven normally.

If the warning display remains on or comes on frequently, have the vehicle checked by an authorized Mitsubishi Motors dealer or a repair facility of your choice.

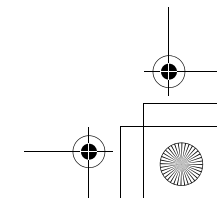
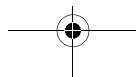
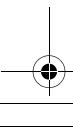
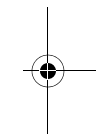

Twin Clutch SST (Sportronic Shift Transmission) (if so equipped)

CAUTION

- If the  warning display is shown, such as when the vehicle does not accelerate while traveling even if the accelerator pedal is depressed, the vehicle may not be able to be driven normally.
For safety, pay attention to your surroundings when driving the vehicle.

NOTE

- If the vehicle is continuously driven on hilly roads or in an aggressive manner involving high engine rpm, sudden acceleration and/or deceleration, the vehicle transmission may vibrate.
This vibration is to alert the driver that the Twin Clutch SST fluid temperature has risen. It does not indicate a malfunction.
If this occurs, perform the same measures for when the  warning appears. If the vibration stops, the vehicle can be driven normally.



If vehicle is driven with warning displayed

If the vehicle continues to be driven after the  warning display appears, and the temperature of the Twin Clutch SST fluid continues to rise, the transmission protection control may operate and cause the transmission to

function as if the gearshift lever was in the “N” (NEUTRAL) position.

(At this time, the vehicle temporarily cannot be driven.)

If this occurs, take the following measures.

1. Depress the brake pedal and stop the vehicle in a safe place.
2. Place the gearshift lever in the “P” (PARK) position, and then open the engine hood with the engine running to cool the engine.
3. After a while, check that the  warning display has gone out, and then stop the engine if the  warning display has gone out.
4. If the engine can be restarted, the vehicle can be driven normally.

If the warning display remains on or comes on frequently, have the vehicle checked by an authorized Mitsubishi Motors dealer or a repair facility of your choice.

When warning display is showing

N00543200039

A safety device in the Twin Clutch SST has been activated due to a possible malfunction in the Twin Clutch SST or in the engine electronic control module.

If this occurs, perform the following procedure.

1. Park your vehicle in a safe place and stop the engine.
2. Restart the engine.

If the  warning display goes out, there is no abnormal condition.

However, if the warning display remains on or comes on frequently, have the vehicle checked by an authorized Mitsubishi Motors dealer or a repair facility of your choice as soon as possible.

5

CAUTION

- If the  warning display is shown, such as when the vehicle does not accelerate while traveling even if the accelerator pedal is depressed, the vehicle may not be able to be driven normally.
For safety, pay attention to your surroundings when driving the vehicle.

Twin Clutch SST (Sportronic Shift Transmission) (if so equipped)

Gearshift lever positions (Main shift gate)

N00540100011

“P” PARK

5

This position locks the transmission to prevent the vehicle from moving. The engine can be started from the “PARK” position.

“R” REVERSE

Move the lever to this position only after the vehicle has come to a complete stop.

⚠ CAUTION

- Never shift into the “P” (PARK) or “R” (REVERSE) position while the vehicle is in motion. If the lever is shifted into the “P” (PARK) or “R” (REVERSE) position while the vehicle is in motion, the transmission may be damaged.

“N” NEUTRAL

At this position, the transmission is disengaged. It is the same as the neutral position on a manual transaxle and should be used when the vehicle is not moving for an extended

length of time during driving, such as in a traffic jam.

⚠ WARNING

- Never move the gearshift lever to the “N” (NEUTRAL) position while driving since you could accidentally slip it into the “P” (PARK) or “R” (REVERSE) position and the engine speed could rise, damaging the transmission.
- To prevent the vehicle from rolling when stopped on a slope, the engine should be started in the “P” (PARK) position. Although the engine can be started when the vehicle is in the “N” (NEUTRAL) position, for safety reasons, do not start the engine in the “N” (NEUTRAL) position.
- Always keep your foot on the brake pedal when the vehicle is in “N” (NEUTRAL) position, or when shifting into or out of “N” (NEUTRAL) position, to prevent rolling.

“D” DRIVE

This position is used for most city and highway driving. Engine shifting and braking are done automatically as needed, depending on road conditions.

⚠ CAUTION

- Never shift into the “D” (DRIVE) position from the “R” (REVERSE) position while the vehicle is in motion. If the lever is shifted into the “D” (DRIVE) from the “R” (REVERSE) position while the vehicle is in motion, the transmission may be damaged.

📖 NOTE

- For information on manual shift gate operation, please refer to “Manual shift” on page 5-76.
- When the engine is cold, upshifts occur at a higher vehicle speed than when the engine is warm. This control is performed to quickly warm up the engine. It does not indicate a malfunction. After the vehicle has been driven for a while, upshifts will occur at the regular engine speeds.

Twin Clutch SST control mode



N00540200070

Select the control mode from the following two types to suit the driving conditions.

Twin Clutch SST (Sportronic Shift Transmission) (if so equipped)

Twin Clutch SST control mode	Characteristic
Normal (Control mode when engine is started)	Control mode for normal driving on local roads, freeways, and the like. Smooth shifting is performed at low engine speeds for economical driving with good ride quality.
Sport	Control mode for driving on mountain roads, roads with uphill and downhill slopes, and freeways with long downhill slopes where engine braking is necessary. Compared to “Normal” mode, shifting occurs at higher engine speeds and is quicker. In addition, quick downshifting is possible when the accelerator pedal is depressed for quick acceleration or when the brakes are applied.

NOTE

- When continuously driving on closed circuit tracks or at other locations where the engine is operated at high speeds and under a heavy load, the Twin Clutch SST fluid temperature will have a tendency to rise. In this case, if the temperature rises too high, the  warning display will appear on the information screen in the multi-information display to alert the driver.
If the  warning display appears, be sure to refer to “Warning display” on page 5-72 and follow the appropriate measures.
- The Twin Clutch SST control mode can be selected both when “D” range operation is selected and when manual shifting is selected.
- If you select “Sport” mode while the engine is cold, the transmission may shift up at different speeds compared to that when the engine is warm. This is simply the operation of the control system to warm the engine quickly. It does not indicate a malfunction.
- For slippery road surfaces, such as roads with accumulated snow, “Normal” mode is recommended for smooth shifting at low engine speeds.

Twin Clutch SST control mode switch

N00540300068

When the ignition switch is set to the “ON” position, operate the Twin Clutch SST control mode switch (A) to change the control mode.

5

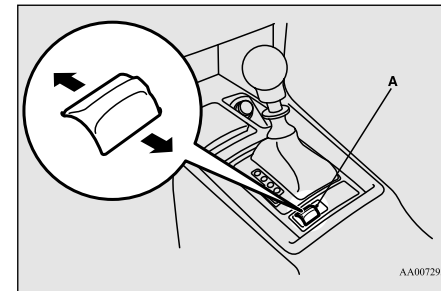

When the engine is started, the control mode is automatically set to the “Normal” mode. Use the following procedures to change the control mode.

To shift from “Normal” mode to “Sport” mode

While the vehicle is stopped or being driven, push the Twin Clutch SST control mode switch forward.

Twin Clutch SST (Sportronic Shift Transmission) (if so equipped)

To shift from “Sport” mode to “Normal” mode

While the vehicle is stopped or being driven, push the Twin Clutch SST control mode switch rearward.

5

NOTE

- If the Twin Clutch SST control mode switch is continuously pressed after a control mode has been selected, an erroneous operation prevention function operates and the control mode is automatically set to the “Normal” mode.

If you would like to select a control mode again, return the ignition switch to the “ACC” or “LOCK” position and restart the engine. Then, push the Twin Clutch SST control mode switch.

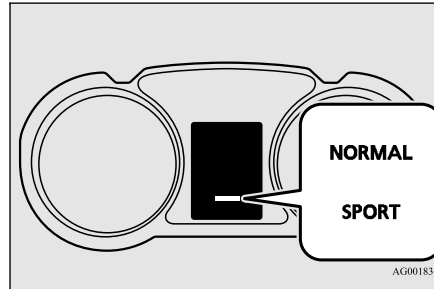

Manual shift

Using the gearshift lever (A) or the sportronic steering wheel shifters (B), shifting can be performed manually.

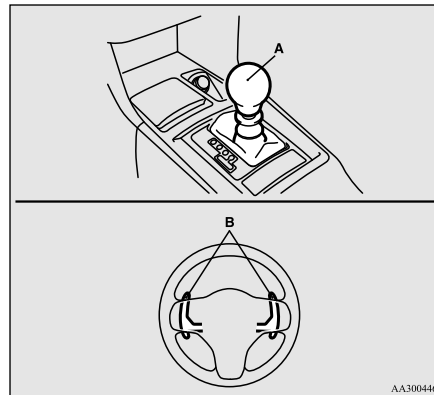

Shifting can be performed even while the accelerator pedal is depressed.

This allows the driver to enjoy sporty driving, such as quick cornering, by nimbly downshifting to reduce vehicle speed just before entering a curve.

CAUTION

- When manually shifting while the vehicle is being driven, select the correct shift position to control the engine speed so that the tachometer indicator does not enter the red zone.
- Sudden engine braking and rapid acceleration can cause the vehicle to skid. Shift down according to road conditions and vehicle speed.
- If both the left and right sportronic steering wheel shifters are operated at the same time, the transmission may not change gears.

Twin Clutch SST control mode display

When the ignition switch is set to the “ON” position, the currently selected control mode is displayed on the multi-information display.

NOTE

- Only the forward gears 1 to 6 can be selected.
To reverse or park, place the gearshift lever in the “R” (REVERSE) or “P” (PARK) position.
- During manual shifting, downshifting will be performed automatically when the vehicle slows down and the transmission will downshift to 1st gear before the vehicle stops.

Twin Clutch SST (Sportronic Shift Transmission) (if so equipped)

NOTE

- If the gearshift lever or sportronic steering wheel shifters are operated repeatedly, the transmission will also shift repeatedly.
- In order to ensure driving performance, upshifting may not occur depending on the vehicle speed even if the gearshift lever or sportronic steering wheel shifters are operated. In addition, in order to prevent excessive engine speed, the buzzer sounds and downshifting may not occur depending on the vehicle speed even if the gearshift lever or sportronic steering wheel shifters are operated.
- When driving in an aggressive manner involving high engine rpm, sudden acceleration and/or deceleration, the Twin Clutch SST could take longer to shift due to higher fluid temperatures.

Shifting using the gearshift lever

N00540600032

Selecting manual shifting

While the vehicle is stopped or being driven, move the gearshift lever from the “D” (DRIVE) position in the main shift gate toward the driver’s seat to select manual shifting.

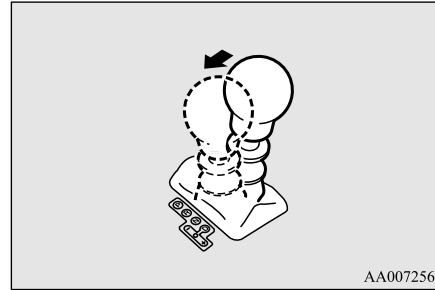

Shifting up and shifting down

Each time the gearshift lever is pulled rearward, the transmission shifts up 1 gear. In addition, each time the gearshift lever is pushed forward, the transmission shifts down 1 gear.

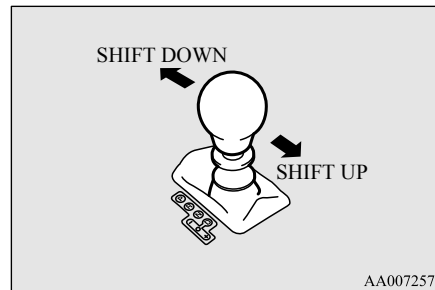

NOTE

- After manual shifting is selected using the gearshift lever, shifting up and down can also be performed using the sportronic steering wheel shifters.

Returning to “D” range operation

Move the gearshift lever toward the front passenger’s seat to return to automated shifting.

5

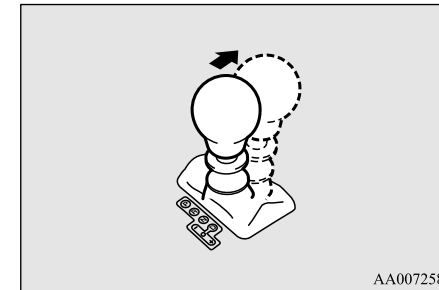

NOTE

- When the gearshift lever is moved to the “D” (DRIVE) position from the manual shift gate, it may automatically select a gear different from the gear selected during manual shifting depending on vehicle speed or driving conditions.

Twin Clutch SST (Sportronic Shift Transmission) (if so equipped)

Shifting using the sportronic steering wheel shifters

N00540700033

Selecting manual shifting

5

While the vehicle is stopped or being driven with the gearshift lever in the “D” (DRIVE) position, manual shifting can be selected by pulling one of the sportronic steering wheel shifters toward you.

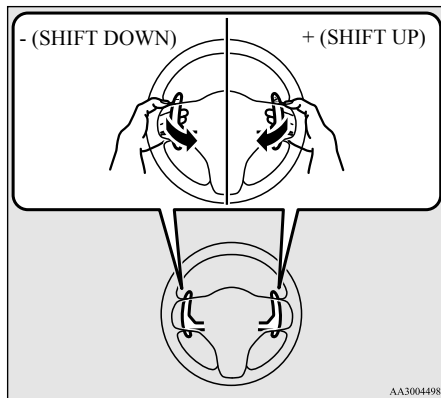

Shifting up

Each time the +(SHIFT UP) sportronic steering wheel shifter is pulled, the transmission shifts up 1 gear.

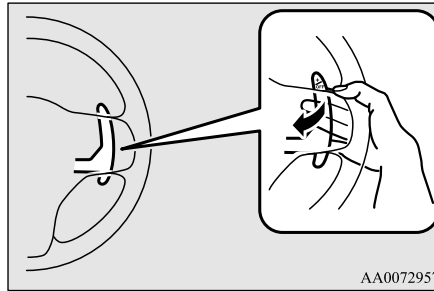

Shifting down

Each time the - (SHIFT DOWN) sportronic steering wheel shifter is pulled, the transmission shifts down 1 gear.

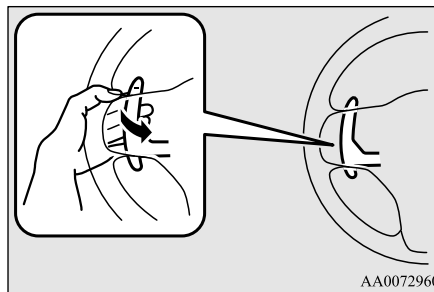

NOTE

- After manual shifting is selected using the sportronic steering wheel shifters, shifting up and down can also be performed using the gearshift lever.

Returning to “D” range operation

When the gearshift lever is in the “D” (DRIVE) position, pull the +(SHIFT UP) sportronic steering wheel shifter toward you for 2 seconds or more to return to “D” range operation.

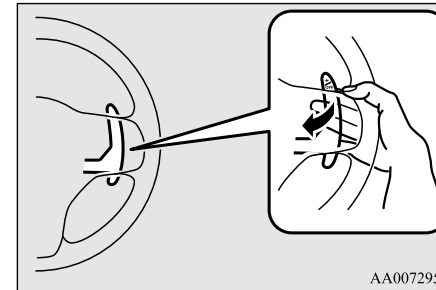

NOTE

- If manual shifting is selected using the sportronic steering wheel shifters when the gearshift lever is in the “D” (DRIVE) position, the transmission will automatically return to “D” range operation before the vehicle stops.

Twin Clutch SST (Sportronic Shift Transmission) (if so equipped)

NOTE

- When the transmission returns to “D” range operation from manual shifting, it may automatically shift up or down from the gear selected using manual shifting depending on the vehicle speed or driving conditions.
- If manual shifting is selected using the sportronic steering wheel shifters, “D” range operation will again be selected by moving the gearshift lever from the “D” (DRIVE) position toward the driver’s seat, then return it toward the front passenger’s seat.

Manual shift display

N00543000040

In manual shift, the currently selected gear is displayed on the multi-information display.

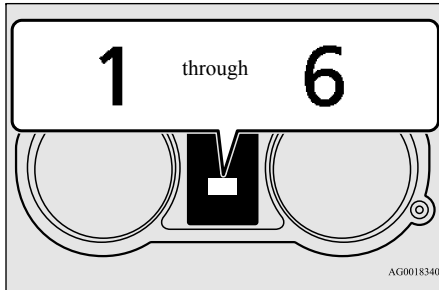

Operation of the Twin Clutch SST

N00540800021

CAUTION

- Before selecting a position with the engine running and the vehicle stationary, fully depress the brake pedal to prevent the vehicle from creeping.
Do not release the brakes until you are ready to drive away. The vehicle will begin to move as soon as the Twin Clutch SST is engaged.
- Depress the brake pedal with the right foot. Using the left foot could cause driver movement delay in case of an emergency.
- To prevent sudden acceleration, never run the engine at high rpms when shifting from the “P” (PARK) or “N” (NEUTRAL) position.
- Operating the accelerator pedal while the other foot is resting on the brake pedal will affect braking efficiency, may cause premature wear of brake pads and may cause engine damage.
- Use the gearshift lever in the correct shift position in accordance with driving conditions.
Never coast downhill backward in the driving shift position { “D” (DRIVE) or manual shifting } or coast forward in the “R” (REVERSE) position.
Engine stopping and increased brake pedal and steering effort could lead to an accident.

CAUTION

- Do not rev the engine with the brake pedal pressed when the vehicle is stationary. This can cause sudden acceleration and damage the Twin Clutch SST.
Also, when you depress the accelerator pedal while holding down the brake pedal with the gearshift lever in the “D” (DRIVE) position, the engine revolutions may not rise as high as when performing the same operation with the gearshift lever in the “N” (NEUTRAL) position.

5

Passing acceleration

N00540900019

To gain extra acceleration in “D” (DRIVE) position (when passing another vehicle) push the accelerator to the floor if it is safe to do so in traffic conditions. The Twin Clutch SST will automatically downshift.

NOTE

- In manual shift, downshifts do not take place when the accelerator is depressed all the way to the floor.

Twin Clutch SST (Sportronic Shift Transmission) (if so equipped)

Uphill/downhill driving

N00541600039

DRIVING UPHILL

The Twin Clutch SST may not upshift to a higher shift position if the computer determines the current speed cannot be maintained once a higher shift position is engaged.

5

For smoother vehicle performance, if you release the throttle while climbing a steep grade, the Twin Clutch SST may not upshift. This is normal, as the computer is temporarily preventing shifting. After reaching the top of the hill, normal shift function will resume.

CAUTION



- Do not use the tendency of the vehicle to creep forward in order to drive at low speeds up hills.

The transmission may be damaged and an accident may occur due to the following conditions.

- The Twin Clutch SST fluid temperature will rise and can cause transmission damage.

CAUTION

- If the vehicle is continuously driven at low speeds using the tendency of the vehicle to creep forward, the vehicle will vibrate or the  warning display will appear on the information screen in the multi-information display to alert the driver that the Twin Clutch SST fluid temperature has risen. After that, if the Twin Clutch SST fluid temperature rises even higher, the transmission protection control will operate. If this occurs, the vehicle may suddenly reverse as if the gearshift lever was in the “N” (NEUTRAL) position and cause an accident.

If the  warning display appears or the transmission protection control operates, refer to “When  warning display is showing” on page 5-72.

DRIVING DOWNHILL

When traveling down steep grades, the computer may automatically select a lower shift position. This function assists engine braking efforts, reducing the need for using the service brakes.

Waiting

N00541000033

For short waiting periods, such as at traffic lights, the vehicle can be left in gearshift

lever position and held stationary with the service brake.

For longer waiting periods with the engine running, place the gearshift lever in the “N” (NEUTRAL) position and apply the parking brake, while holding the vehicle stationary with the service brake.

Prior to moving off after having stopped the vehicle, make sure that the gearshift lever is in “D” (DRIVE) position or manual shift position.



CAUTION

- Do not rev the engine unnecessarily while the vehicle is stationary. Unexpected acceleration may occur if the gearshift lever is in a position other than “P” (PARK) or “N” (NEUTRAL).
- Do not keep the vehicle in a stopped position on an uphill slope by depressing the accelerator pedal instead of the brake pedal. The transmission may be damaged and an accident may occur due to the following conditions.
 - The Twin Clutch SST fluid temperature will rise and can cause transmission damage.

Twin Clutch SST (Sportronic Shift Transmission) (if so equipped)

CAUTION

- If the vehicle is kept in a stopped position by depressing the accelerator pedal instead of the brake pedal, the vehicle will vibrate or the  warning display will appear on the information screen in the multi-information display to alert the driver that the Twin Clutch SST fluid temperature has risen. After that, if the Twin Clutch SST fluid temperature rises even higher, the transmission protection control will operate. If this occurs, the vehicle may suddenly reverse as if the gearshift lever was in the “N” (NEUTRAL) position and cause an accident.

If the  warning display appears or the transmission protection control operates, refer to “When  warning display is showing” on page 5-72.

Parking

N00541100018

To park the vehicle, first bring it to a complete stop, fully engage the parking brake, and then move the gearshift lever to the “P” (PARK) position.

What to do if the following occur with the Twin Clutch SST

N00541201087

If there is a malfunction in the Twin Clutch SST or engine electronic control module, the following may occur.

- Twin Clutch SST does not shift.
- Vehicle cannot move.
- Twin Clutch SST acceleration is slow.
- Vehicle does not creep.
- “Shift shock” is large.
- Shifting occurs at higher engine speed.
- Response is slow.

If any of these occurs, perform the following procedure.

When  warning display is showing

The temperature of Twin Clutch SST fluid is high.

Refer to “Warning display” on page 5-72 and follow the appropriate measures.

When the engine malfunction indicator (“SERVICE ENGINE SOON” or “Check engine light”) comes on or blinking

There could be a malfunction in the engine electronic control module.

Refer to “Engine malfunction indicator (“SERVICE ENGINE SOON” or “Check engine light”)” on page 5-144 and follow the appropriate measures.

When the gearshift lever position display is not showing**5**

A safety device in the Twin Clutch SST has been activated due to a possible malfunction in the Twin Clutch SST.

Refer to “If the gearshift lever position display is not showing” on page 5-72 and follow the appropriate measures.

When  warning display is showing or when no warning is showing in the multi-information display

A safety device in the Twin Clutch SST has been activated due to a possible malfunction in the Twin Clutch SST or in the engine electronic control module.

Perform the following procedure.

1. Park your vehicle in a safe place and stop the engine.
2. Restart the engine.

If the vehicle moves and accelerates normally after this procedure is performed, there is no malfunction in the transmission.

ACD (Active center differential system) (if so equipped)

However, if the vehicle does not move or accelerate normally, or if this problem occurs repeatedly, have the vehicle checked by an authorized Mitsubishi Motors dealer or a repair facility of your choice as soon as possible.

5

CAUTION

- When the Twin Clutch SST fluid temperature is high, the engine idle speed when the vehicle is stopped may increase or the vehicle will have a weak tendency to creep. After that, if the Twin Clutch SST fluid temperature rises even higher, the warning  display will appear.

ACD (Active center differential system) (if so equipped)

N00538500034

The ACD is a system that improves acceleration performance and straight-ahead stability by regulating the differential limiting action and power drive distribution of the center differential.

CAUTION

- Do not over-rely on the ACD. Even the ACD cannot prevent the natural laws of physics from acting on the vehicle. This system, like any other system, has limits and cannot help you to maintain traction and control of the vehicle in all circumstances. Reckless driving can lead to accidents. It is the driver's responsibility to drive carefully. This means taking into account the traffic, road and environmental conditions.
- Be sure to use tires that are the same specified size, type, and brand, and have no difference in the amount of wear for all four wheels. Otherwise, the ACD may not work properly.

NOTE

- If the parking brake lever is pulled up while the vehicle is moving, the center differential is designed to switch to a free state condition which will allow the rear wheel to lock easier.

ACD control mode

N00545400048

Select the control mode from the following three types to suit the driving conditions.

ACD control mode	Operation
TARMAC	Normally, use this control mode. Use this mode for paved roads.
GRAVEL	Use this control mode when driving on somewhat slippery road surfaces, such as wet road surfaces and gravel roads.
SNOW	Use this control mode when driving on slippery road surfaces, such as snow-covered roads.

ACD control mode switch

When the ignition switch is set to the "ON" position, operate the AWC switch to change the control mode.

Each time the switch is pushed, the control mode changes in the order "TARMAC" → "GRAVEL" → "SNOW" → "TARMAC".

ACD (Active center differential system) (if so equipped)

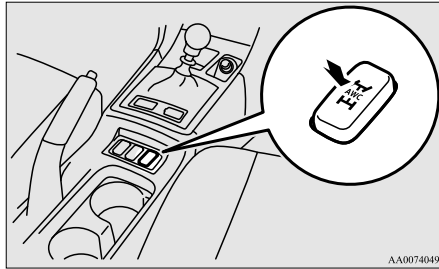

AA0074049

NOTE

- The control mode can be changed while the vehicle is moving.
- The selected control mode is stored in memory even if the engine is stopped. However, if a battery terminal is disconnected, the control mode stored in memory will be erased and the control mode will be set to the "TARMAC" mode.

ACD control mode display

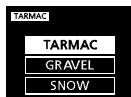

Example: "TARMAC" mode is selected.

The currently selected control mode is displayed on the multi-information display.

In addition, when the control mode is changed, the selected mode appears on the interrupt display screen of the information screen in the multi-information display.

The control mode display will appear on the information screen for a few seconds, and then the original screen will return.

CAUTION

- The ACD control mode display may flash under aggressive driving conditions. At this time, ACD control is temporarily suspended in order to protect the ACD device, but this will not affect normal driving. After the vehicle is driven for a while, if the ACD control mode display remains on, the ACD control will start operating again.

ACD warning display

N00545700041

When there is a malfunction in the system, the  warning display will appear on the information screen in the multi-information display.

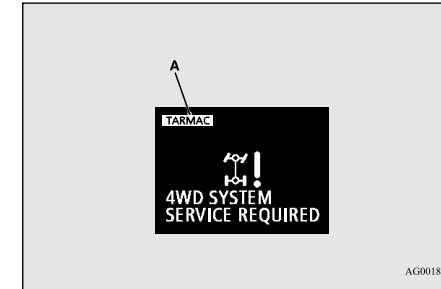

In addition, the ACD control mode display in section (A) will go out at the same time.



AG0018412

5

CAUTION

- The system may be malfunctioning. Park your vehicle in a safe place and stop the engine. Restart the engine and check whether the  warning display goes out. If the  warning display goes out, there is no abnormal condition. If the  warning display does not go out or appears frequently, it is not necessary to stop the vehicle immediately, but we recommend you to have your vehicle inspected.

Electronically controlled 4WD system (if so equipped)

5

NOTE

- If the ambient temperature drops and the viscosity of the AWC control fluid increases, the warning may be displayed. At this time, ACD control is temporarily suspended, but this will not affect normal driving.
- After the vehicle is driven for a while, if the engine is restarted after the AWC control fluid warms up or the ambient temperature increases, the ACD control will start operating again if the warning display goes out.

Electronically controlled 4WD system (if so equipped)
N00548300019

The electronically controlled 4WD system is an all-wheel drive system that allows one of three drive modes to be selected with a switch, in accordance with the driving conditions.

The following drive modes are available.

Drive mode	Function
2WD	This mode is for economical driving on normal dry roads and freeways. Driving in front-wheel drive.

Drive mode	Function
4WD AUTO	The default mode. This mode is for automatically controlling the distribution of driving torque to all four wheels according to the driving conditions.
4WD LOCK	This mode is for driving in slippery conditions such as on snow-covered roads or sand. The large amount of driving torque that is applied to the rear tires enables getting out of slippery areas and powerful driving is possible across all ranges.

4-wheel drive operation requires special driving skills. Carefully read the “All-wheel driving operation” section on page 5-86 and take care to drive safely.

Drive mode-selector
N00548400010

The drive mode can be selected by pressing the switch while the ignition switch is in the “ON” position.

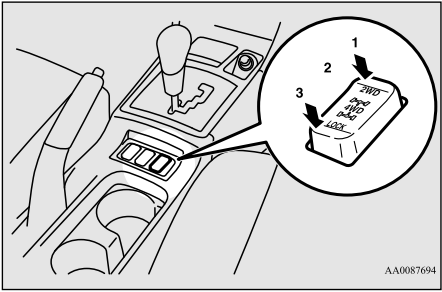



- 1- 2WD
- 2- 4WD AUTO
- 3- 4WD LOCK

The drive mode is displayed as an interrupt display on the information screen in the multi-information display when the drive mode is switched. After a few seconds, the information screen returns from the drive mode display to the previous screen.

Drive mode	Display	
	Type 1	Type 2
2WD		
4WD AUTO		

Electronically controlled 4WD system (if so equipped)

Drive mode	Display	
	Type 1	Type 2
4WD LOCK		

CAUTION

- Do not operate the drive mode-selector with the front wheels spinning on a snowy road or in similar conditions. The vehicle could lunge in an unexpected direction.
- Driving on dry, paved roads in “4WD LOCK” mode causes increased fuel consumption, noise, and premature tire wear.
- Do not drive with the tires spinning in “2WD” mode.
Doing so could generate heat in the drive-system components.

NOTE

- The drive mode can be switched while driving or stopped.

Drive mode indicator

N00549400017



Type 2



Normally the indicator illuminates when the ignition switch is turned to the “ON” position, and then the drive mode is displayed a few seconds after the engine is started. The status of each drive mode display is as follows.

Drive mode	Drive mode indicator	
	“4WD” indicator	“LOCK” indicator
2WD	OFF	OFF
4WD AUTO	ON	OFF
4WD LOCK	ON	ON

CAUTION

- If the selected drive mode indicator is blinking, the vehicle switches automatically to front-wheel drive in order to protect the drive-system components, and drive mode selection is no longer possible with the drive mode-selector. The warning display is also displayed in the information screen in the multi-information display. Reduce speed, and if the indicator goes out after driving a while, resume driving as before. If the indicator continues blinking for more than about 5 minutes, have the vehicle inspected at an authorized Mitsubishi Motors dealer or a repair facility of your choice as soon as possible.

5

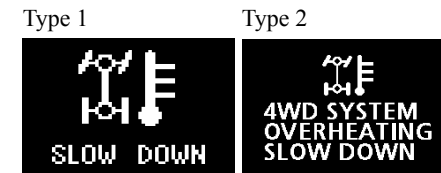

All-wheel driving operation

CAUTION

- The warning display on the information screen in the multi-information display, a problem has occurred with the electronically controlled 4WD system and the safety device has activated. Have an inspection made by an authorized Mitsubishi Motors dealer or a repair facility of your choice as soon as possible.

5

Type 1



Type 2



CAUTION

- Always use tires of the same size, type, and brand that have no wear differences. Using tires that differ in size, type, brand, or wear amount may activate the protection of the drive-system components, causing the drive mode in “4WD AUTO” mode to lock or the “4WD” and “LOCK” indicators to blink alternately.

All-wheel driving operation

N00530600169

For vehicles with full-time 4WD

Full-time 4WD vehicles are propelled by engine power distributed constantly and appropriately to all 4 wheels.

Not only does this ensure enhanced handling on dry, paved roads but also permits better traction when driving on slippery, wet or snow-covered roads and when moving out of mud.

These vehicles, however, are not designed for off-road use, and are unsuitable for driving on bumpy ground that may cause excessive strain. Full-time 4WD vehicles should be driven only under the same conditions as are suitable for ordinary front-wheel drive vehicles.

For vehicles with electronically controlled 4WD system

Electronically controlled 4WD system vehicles are propelled by engine power distributed constantly and appropriately to all 4 wheels.

Not only does this ensure enhanced handling on dry, paved roads but also permits better

traction when driving on slippery, wet or snow-covered roads and when moving out of mud.

These vehicles, however, are not designed for off-road use, and are unsuitable for driving on bumpy ground that may cause excessive strain. Electronically controlled 4WD system vehicles should be driven only under the same conditions as are suitable for ordinary front-wheel drive vehicles.

Turning sharp corners

When turning a sharp corner in “4WD LOCK” position at low speed, a slight difference in steering may be experienced similar to feeling as if the brakes were applied. This is called tight corner braking and results from each of the four tires being at a different distance from the corner. The phenomenon is typical of 4-wheel drive vehicles. If this occurs, either straighten out the steering wheel, or change to “2WD” or “4WD AUTO” mode.

On snowy or icy roads



Set the drive mode-selector to “4WD AUTO” or “4WD LOCK” in accordance with the road conditions, and then gradually depress the accelerator pedal for a smooth start.

Cautions on handling of all-wheel drive vehicles

NOTE

- The use of snow tires is recommended.
- Maintain a safe distance between vehicles, avoid sudden braking, and use engine braking (downshifting).

CAUTION

- The “” warning display or the “” warning display appear on the information screen in the multi-information display. Refer to “Warning display” on page 5-64.

CAUTION

- Avoid sudden braking, sudden acceleration, and sharp turning. Skidding occurs and control of the vehicle could be lost.

WARNING

- **When attempting to rock your vehicle out of a stuck position, be sure that the area around the vehicle is clear of people and physical objects. The rocking motion may cause the vehicle to suddenly launch forward/backward, causing injury or damage to nearby people or objects.**

Moving out of mud

Set the drive mode-selector to “4WD LOCK” and then gradually depress the accelerator pedal for a smooth start.

Keep the pressure on the accelerator pedal as constant as possible, and drive at low speed.

CAUTION

- If any of the following conditions occur, follow these procedures:
 - The engine coolant temperature display  appears on the information screen in the multi-information display or the engine power drops suddenly. Refer to “Engine overheating” on page 8-4.

NOTE

- Avoid sudden braking, sudden acceleration and sharp turning; such operations could result in the vehicle becoming stuck.
- If the vehicle becomes stuck in muddy roads, it can often be moved with a rocking motion. Move the selector lever alternately between “D” (DRIVE) and “R” (REVERSE) positions, while pressing lightly on the accelerator pedal.

Climbing/descending sharp grades

Your vehicle may not provide sufficient hill climbing ability and engine braking on steep slopes. Avoid driving on steep slopes even though the vehicle is a 4-wheel drive vehicle.

Cautions on handling of all-wheel drive vehicles

N00530800190

5

Tires and wheels

Since driving torque can be applied to all four wheels, the performance of the vehicle when operating in all-wheel drive is greatly affected by the condition of the tires.

Pay close attention to the tires.

- Install specified tires on all wheels. Refer to “Tires and wheels” on page 11-5.
- Be sure to fit all four tires and wheels of the same size and type. When replacement of any of the tires or wheels is necessary, replace all of them.
- All tires should be rotated whenever the wear difference between the front and rear tires is recognizable.

Limited-slip differential (if so equipped)

Good vehicle performance cannot be expected if there is a difference in wear between tires. Refer to “Tire rotation” on page 9-23.

- Check the tire inflation pressure regularly.

5

CAUTION

- Always use tires of the same size, same type, and same brand, and which have no wear differences. Using tires that differ in size, type, brands or the degree of wear, will increase the differential oil temperature, resulting in possible damage to the driving system. Further, the drive train will be subjected to excessive loading, possibly leading to oil leakage, component seizure, or other serious problems.

Towing

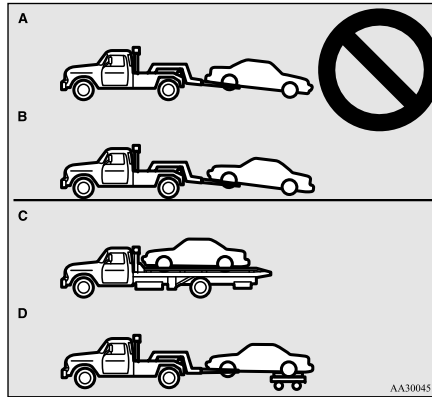

CAUTION

- Do not tow all-wheel drive vehicles with the front or rear wheels on the ground (Type A or Type B) as illustrated. This could result in damage to the drivetrain, or unstable towing. If you tow all-wheel drive vehicles, use Type C or Type D equipment.
- [For vehicle equipped with the Electronically controlled 4WD system]
Even in “2WD” mode, the vehicle cannot be towed with the front or the rear wheels on the ground.

Jacking up a all-wheel drive vehicles

WARNING

- Do not start or run the engine while the vehicle is on the jack. The jack could slip out of position and result in an accident.

Limited-slip differential (if so equipped)

N00517400069

A limited-slip differential is applied for rear wheel differential. The features of this limited-slip differential are described below:

Just as with a conventional differential, the wheel on one side is allowed to turn at a different speed from the wheel on the other side when the vehicle is cornering. The difference between the limited-slip differential and a conventional differential is that if the wheel on one side of the vehicle loses traction, a greater amount of torque is applied to the wheel on the other side to improve traction.

NOTE

- Even if there is a difference in the amount of traction the wheels can get, if both of them are spinning, the limited-slip differential will not be effective.

CAUTION

- Never start the engine while one of the front or rear wheels is jacked up and the other in contact with the ground; doing so may cause the vehicle to jump forward.
- Continuously attempting to extract the vehicle from snow, mud, etc. while using high engine rpm may damage the limited-slip differential.
- Using a compact spare wheel will adversely affect the limited-slip differential; replace the compact spare wheel with a standard size wheel as soon as possible.

Service brake

N00517500262

Brake pedal

Overuse of the brake can cause poor brake response and premature wear of the brake pads and linings.

When driving down a long or steep hill, use engine braking by downshifting.

WARNING

- **Do not leave any objects near the brake pedal or let a floor mat slide under it; doing so could prevent the full pedal stroke that would be necessary in an emergency. Make sure that the pedal can be operated freely at all times. Make sure the floor mat is securely held in place.**

CAUTION

- It is important not to drive the vehicle with your foot resting on the brake pedal when braking is not required. This practice can result in very high brake temperatures, premature pad and lining wear, and possible damage to the brakes.

Power brakes

N00517600377

Your vehicle is equipped with power brakes for more braking force with minimal brake pedal effort.

Your brakes are designed to operate at full capacity, even if the power assist is lost.

If the power assist is lost, the effort needed to press the brake pedal is greater.

If you should lose the power assist for some reason, the brakes will still work.

If the power brake unit or either of the two brake hydraulic systems stops working prop-

Service brake

erly, the rest of the brake system will still work, but the vehicle will not slow down as quickly.

You will know this has happened if you find you need to depress the brake pedal down further, or harder when slowing down or stopping, or if the brake warning light and the warning display in the multi-information display come on.

5**WARNING**

- **Never coast downhill with the engine OFF. Keep the engine running whenever your vehicle is in motion. If you turn off the engine while driving, the power brake booster will stop working and your brakes will not work as well.**
- **If the power assist is lost or if either brake hydraulic system stops working properly, take your vehicle to an authorized Mitsubishi Motors dealer or a repair facility of your choice immediately.**

Brake pad wear alarm

N00532500087

The disc brakes have an alarm that makes a metallic squeal when the brake pads have worn down enough to need service. If you hear this sound, have the brake pads replaced at an authorized Mitsubishi Motors dealer or a repair facility of your choice.

Brake assist system

WARNING

- **Driving with worn brake pads will make it harder to stop, and can cause an accident.**

Brake assist system

N00567300076

5

The brake assist system is a device assisting drivers who cannot depress the brake pedal firmly such as in emergency stop situations and provides greater braking force.

If the brake pedal is depressed suddenly, the brakes will be applied with more force than usual.

CAUTION

- The brake assist system is not a device designed to exercise braking force greater than its capacity. Make sure to always keep a sufficient distance between vehicles in front of you without relying too much on the brake assist system.

NOTE

- Once the brake assist system is operational, it maintains great braking force even if the brake pedal is lightly released. To stop its operation, completely remove your foot from the brake pedal.

NOTE

- The brake assist system may become operational when the brake pedal is fully depressed even if it has not been depressed suddenly.
- When the brake assist system is in use while driving, you may feel as if the depressed brake pedal is soft, the pedal moves in small motions in conjunction with the operation noise, or the vehicle body and the steering wheel vibrate. This occurs when the brake assist system is operating normally and does not indicate faulty operation. Continue to depress the brake pedal.
- You may hear an operation noise when the brake pedal is suddenly or fully depressed while stationary. This does not indicate a malfunction and the brake assist system is operating normally.

Hill start assist (vehicles with Twin Clutch SST)

N00562600032

The hill start assist makes it easy to start off on a steep uphill slope by preventing the vehicle from moving backwards. It keeps the braking force for about 2 seconds when you move your foot from the brake pedal to the accelerator pedal.

CAUTION

- Do not overly rely on the hill start assist to prevent backwards movement of the vehicle. Under certain circumstances, even when hill start assist is activated, the vehicle may move backwards if the brake pedal is not sufficiently depressed, if the vehicle is heavily loaded, or if the road is very steep or slippery.
- The hill start assist is not designed to keep the vehicle stopped in place on uphill slopes for more than 2 seconds.
- When facing uphill, do not rely on using the hill start assist to maintain a stopped position as an alternative to depressing the brake pedal. Doing so could cause an accident.
- Do not turn the ignition switch to the "LOCK" or "ACC" position while the hill start assist is operating. The hill start assist could stop operating, which could result in an accident.

To operate

N00562700062

1. Stop the vehicle completely using the brake pedal.
2. Release the brake pedal and the hill start assist will maintain the braking force applied while stopping for approximately 2 seconds.

3. Depress the accelerator pedal and the hill start assist gradually will decrease the braking force as the vehicle starts moving.

NOTE

- The hill start assist is activated when all of the following conditions are met.
 - The engine is running.
(The hill start assist will not be activated while the engine is starting or immediately after the engine is started.)
 - The gearshift lever is in any position other than "P" (PARK) or "N" (NEUTRAL).
 - The vehicle is completely stationary, with the brake pedal depressed.
 - The parking brake is released.
- The hill start assist will not operate if the accelerator pedal is depressed before the brake pedal is released.
- The hill start assist also operates when reversing on an uphill slope.

Warning display

N00562800063

If an abnormal condition occurs in the system, the following display/indicator will turn on.

 - ASC indicator

Warning display



CAUTION

- If the warning is displayed, the hill start assist will not operate. Start off carefully.
- Park your vehicle in a safe place and stop the engine. Restart the engine and check whether the display/indicator goes out, in which case the hill start assist is again working normally. If they remain displayed or reappear frequently, it is not necessary to stop the vehicle immediately, but the vehicle should be inspected by an authorized Mitsubishi Motors dealer or a repair facility of your choice as soon as possible.

Anti-lock braking system

N00517900309

The anti-lock braking system helps prevent the wheels from locking up when braking. This helps you keep control of your vehicle and its direction.

Anti-lock braking system

Driving hints

- When using the anti-lock brakes (sudden braking), steering is slightly different from normal driving conditions. Use the steering wheel carefully.
- Always keep a safe distance from the vehicle in front of you. Even if your vehicle is equipped with the anti-lock braking system, leave a greater braking distance when:
 - Driving on gravel or snow-covered roads.
 - Driving on uneven road surfaces.
- Operation of anti-lock braking system is not restricted to situations where brakes are applied suddenly. This system may also prevent the wheels from locking when you drive over manholes, steel roadwork plates, road markings, or any uneven road surface.
- When the anti-lock braking system is in use, you may feel the brake pedal vibrating and hear a unique sound. You may also feel as if the pedal resists being pressed.
In this situation, simply hold the brake pedal down firmly. Do not pump the brake, which will result in reduced braking performance.

5

Anti-lock braking system

5

⚠ CAUTION

- The anti-lock braking system cannot prevent accidents. It is your responsibility to take safety precautions and to drive carefully.
- To prevent failure of the anti-lock braking system, be sure all four wheels and tires are the same size and the same type.
- Never install a limited slip differential as the ABS may not function normally. Please consult an authorized Mitsubishi Motors dealer.

📖 NOTE

- After your vehicle is driven a short distance after starting the engine, you will hear the sound coming from the engine compartment. These are the normal sounds the anti-lock braking system makes when performing a self-check. It does not indicate a malfunction.
- The anti-lock braking system can be used after the vehicle has reached a speed over approximately 6 mph (10 km/h). It stops working when the vehicle slows below approximately 3 mph (5 km/h).

Anti-lock braking system warning light / display

N00531600573

Warning light



Warning display type 1



Warning display type 2



If there is a malfunction in the system, the anti-lock braking system warning light will come on and the warning display will appear on the information screen in the multi-information display.

Under normal conditions, the anti-lock braking system warning light only comes on when the ignition switch is turned to the “ON” position and goes off a few seconds later.

⚠ CAUTION

- Any of the following warning light/display behavior indicates that the anti-lock braking system is not functioning and only the standard brake system is working. (The standard brake system will still work properly.) If this happens, take your vehicle to an authorized Mitsubishi Motors dealer or a repair facility of your choice as soon as possible.
 - When the ignition switch is in the “ON” position, the warning light does not come on or it remains on and does not go off
 - The warning light comes on while driving
 - The warning display appears while driving

If the warning light / display comes on while driving

N00531700503

If only the anti-lock braking system warning light / display comes on

- Avoid hard braking and high-speed driving. Stop the vehicle in a safe place. Test the system by restarting the engine and driving at a speed of about 12 mph (20 km/h) or higher. If the warning light / display then remain off during driving, there is no problem.

However, if the warning light / display do not disappear, or if they come on again when the vehicle is driven, have the vehicle checked by an authorized Mitsubishi Motors dealer or repair facility of your choice as soon as possible.

If the anti-lock braking system warning light / display and brake warning light / display come on at the same time

Warning light



Warning display type 1



Warning display type 2



The anti-lock braking system and brake force distribution function may not work, so hard braking could make the vehicle unstable. Avoid hard braking and high-speed driving. Stop the vehicle in a safe place and contact an authorized Mitsubishi Motors dealer or repair facility of your choice.

NOTE

- The anti-lock braking system warning light and brake warning light illuminate at the same time and the warning displays appear alternately on the information screen in the multi-information display.

After driving on icy roads

N00529200022

After driving on snow or icy roads, remove any snow and ice which may have been left around the wheels. On vehicles that have an

Anti-lock braking system

anti-lock braking system, be careful not to damage the wheel speed sensors (A) or the cables located at each wheel.

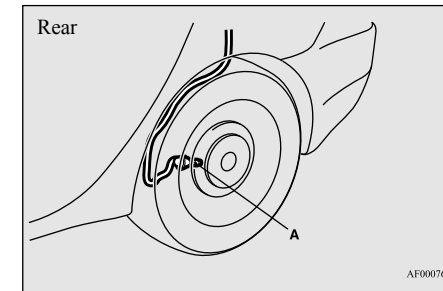
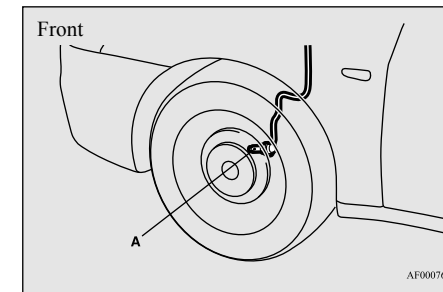

5

Active Stability Control (ASC) (if so equipped)

Active Stability Control (ASC) (if so equipped)

N00559100118

The Active Stability Control (ASC) takes overall control of the anti-lock braking system, traction control function and skid control function to help maintain the vehicle's control and traction. Please read this section in conjunction with the page on the anti-lock braking system, traction control function and skid control function.

5

Anti-lock braking system (ABS) → P.5-91
Traction control function → P.5-94
Skid control function → P.5-94

CAUTION

- Do not over-rely on the ASC. Even the ASC cannot prevent the natural laws of physics from acting on the vehicle. This system, like any other system, has limits and cannot help you to maintain traction and control of the vehicle in all circumstances. Reckless driving can lead to accidents. It is the driver's responsibility to drive carefully. This means taking into account the traffic, road and environmental conditions.
- Be sure to use the same specified type and size of tire on all four wheels. Otherwise, the ASC may not work properly.

CAUTION

- Do not install any aftermarket limited slip differential (LSD) on your vehicle. The ASC may stop functioning properly.

NOTE

- An operation noise may be emitted from the engine compartment in the following situations. The sound is associated with checking the operations of the ASC. At this time, you may feel a shock from the brake pedal if you depress it. These do not indicate a malfunction.
 - When the ignition switch is set to the "ON" position.
 - When the vehicle is driven for a while after the engine is turned on.
- When the ASC is activated, you may feel a vibration in the vehicle body or hear a whining sound from the engine compartment. This indicates that the system is operating normally. It does not indicate a malfunction.
- When the anti-lock braking system warning light is illuminated, the ASC is not active.

Traction control function

N00559200034

On slippery surfaces, the traction control function prevents the drive wheels from spinning excessive, thus helping the vehicle to start moving from a stopped condition. It also

provides sufficient driving force and steering performance as the vehicle turns while pressing the acceleration pedal.

CAUTION

- When driving a vehicle on a snowy or icy road, be sure to install snow tires and drive the vehicle at moderate speeds.

Skid control function

N00559300035

The skid control function is designed to help the driver maintain control of the vehicle on slippery roads or during rapid steering maneuvers. It works by controlling the engine output and the brake on each wheel.

NOTE



- The skid control function operates at speeds of about 9 mph (15 km/h) or higher.

"ASC OFF" switch

N00559400179

The ASC is automatically activated when the ignition switch is turned to the "ON" position. You can deactivate the system by pressing down the "ASC OFF" switch for 3 seconds or longer.

Active Stability Control (ASC) (if so equipped)

When the ASC is deactivated, the  display/indicator will turn on. To reactivate the ASC, momentarily press the “ASC OFF” switch ; the  display/indicator is turned off.

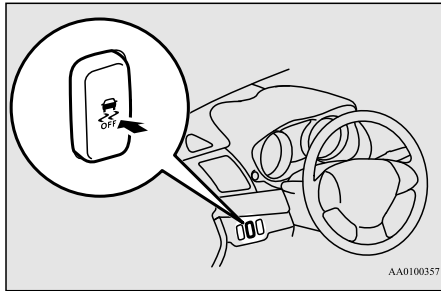

AA0100357

CAUTION

- For safety reasons, the “ASC OFF” switch should be operated when your vehicle is stopped.
- Be sure to keep the ASC on while driving in normal circumstances.

NOTE



- Using the “ASC OFF” switch turns off both the skid control function and the traction control function.

NOTE

- When moving out of mud, sand or fresh snow, pressing the accelerator pedal may not allow the engine speed to increase. In such situations, temporarily turning off ASC with the “ASC OFF” switch will make it easier to move out your vehicle.
- If you continue to press the “ASC OFF” switch after the ASC is turned off, the “mistaken operation protection function” will activate and the ASC will turn back on.

ASC operation display or ASC OFF display



N00559500183

-  - ASC operation display/ASC indicator
The display/indicator will blink when the ASC is operating.
-  - ASC OFF display/ASC OFF indicator
This display/incicator will turn on when the ASC is turned off with the “ASC OFF” switch.

NOTE



- The combination of items shown on the display varies depending on the vehicle model.

CAUTION

- When  display/indicator blinks, ASC is operating, which means that the road is slippery or that your vehicle’s wheels are beginning to slip. If this happens, drive slower.
- If the temperature in the braking system continues to increase due to continuous brake control on a slippery road surface, the  display/indicator will blink. To prevent the brake system from overheating, the brake control of the traction control function will be temporarily suspended. The engine control of the traction control function and normal brake operation will not be affected. Park your vehicle in a safe place. When the temperature in the braking system has come down, the  display/indicator will be turned off and the traction control function will start operating again.

5

NOTE

- The  display/indicator may come on when you start the engine. This means that the battery voltage momentarily dropped when the engine was started. It does not indicate a malfunction, provided that the display goes out immediately.
- When a spare tire has been put on your vehicle, the gripping ability of the tire will be lower, making it more likely that the  display/indicator will blink.

Power steering system

ASC warning display

N00559500196

If an abnormal condition occurs in the system, the following display/indicator will turn on.

5



- ASC indicator



- ASC OFF display/ASC OFF indicator

Warning display type 1



Warning display type 2



NOTE

- The combination of items shown on the display varies depending on the vehicle model.

CAUTION

- The system may be malfunctioning. Park your vehicle in a safe place and stop the engine. Restart the engine and check whether the display/indicator goes out. If they do not go out or if they turn on frequently, it is not necessary to stop the vehicle immediately, but you should have your vehicle inspected by an authorized Mitsubishi Motors dealer or a repair facility of your choice as soon as possible.

Towing

N00546300015

CAUTION

- When towing the vehicle with only the front wheels or only the rear wheels raised off the ground, do not place the ignition switch in the "ON" position. Placing the ignition switch in the "ON" position could cause the ASC to operate, resulting in an accident. Note that the correct towing method depends on the transmission type and the vehicle's drive configuration. For details, refer to "Towing" on page 8-12.

Power steering system

N00518000310

The power steering system operates while the engine is running. It helps reduce the effort needed to turn the steering wheel.

The power steering system has mechanical steering capability in case the power assist is lost. If the power assist is lost for some reason, you will still be able to steer your vehicle, but you will notice it takes much more effort to steer. If this happens, have your vehicle inspected at an authorized Mitsubishi Motors dealer or a repair facility of your choice.

WARNING

- Do not stop the engine while the vehicle is moving. Stopping the engine would make the steering wheel extremely hard to turn, possibly resulting in an accident.

Hydraulic power steering system (HPS) (if so equipped)

N00547100052

CAUTION

- Do not leave the steering wheel turned all the way in one direction. This can cause damage to the power steering system.

Electric power steering system (EPS) (if so equipped)

N00547200053

NOTE

- During repeated full-lock turning of the steering wheel (for example, while you are manoeuvring the vehicle into a parking space), a protection function may be activated to prevent overheating of the power steering system. This function will make the steering wheel gradually harder to turn. In this event, limit your turning of the steering wheel for a while. When the system has cooled down, the steering effort will return to normal.
- If you turn the steering wheel while the vehicle is stationary with the headlights on, the headlights may become dim. This behavior is not abnormal. The headlights will return to their original brightness after a short while.

Electronic power steering system warning display

Type 1



Type 2



If there is a malfunction in the system, the warning display will appear on the information screen in the multi-information display.

CAUTION

- If the warning display appears while the engine is running, have the vehicle inspected by an authorized Mitsubishi Motors dealer or a repair facility of your choice as soon as possible. It may become harder to turn the steering wheel.

Cruise control (if so equipped)

N00518300528

Cruise control is an automatic speed control system. It lets you keep the same driving speed. Cruise control can be activated at about 25 mph (40 km/h) or more. It is especially useful for freeway driving. Cruise control does not work at speeds below about 25 mph (40 km/h).

Cruise control (if so equipped)

CAUTION

- For safety reasons, the cruise control system should be set to the “OFF” position by pressing the “ON OFF” switch (A) when you are not using the cruise control system.
- Do not use cruise control when driving conditions will not allow you to stay at the same speed, such as in heavy traffic or on roads that are winding, icy, snowy, wet, slippery or on a steep downhill slope.
- On vehicles with manual transaxle, do not move the gearshift lever to the “N” (Neutral) position while driving at a set speed without depressing the clutch pedal. The engine will run too fast and might be damaged.

5

NOTE

- Cruise control may not be able to keep your speed on uphill or downhill.
- Your speed may drop on a steep uphill. You may have to use the accelerator pedal if you want to stay at your set speed.
- Your speed may increase to more than the set speed on a steep downhill. You must use the brake to control your speed.

Cruise control (if so equipped)

Cruise control switches

5

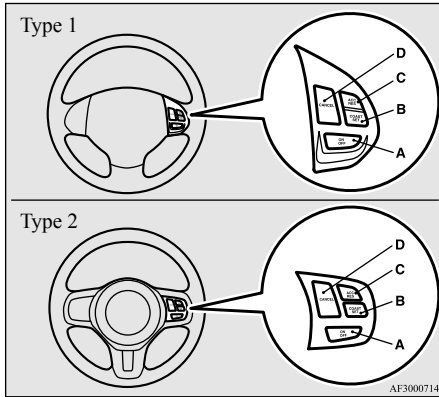

A- "ON OFF" switch

To activate and deactivate the cruise control function.

B- "COAST SET" switch

To reduce the set speed and to set the speed of constant-speed driving.

C- "ACC RES" switch

To increase the set speed and to resume to the previous set speed.

D- "CANCEL" switch

To terminate constant-speed driving.

NOTE

- When operating the cruise control switches, correctly press each cruise control switch. The cruise control may be turned off automatically if two or more of the cruise control switches are pressed at the same time.

Cruise control indicator

N00550100245

This indicator will come on when the cruise control "ON OFF" switch (A) is pressed to turn on the cruise control system.

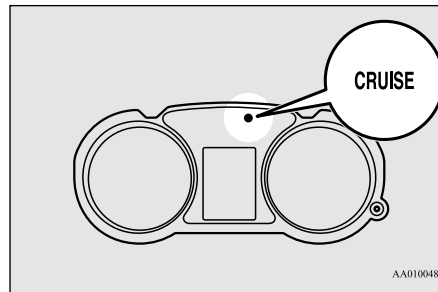

To activate

N00518400343

- Lightly press the "ON OFF" switch (A).

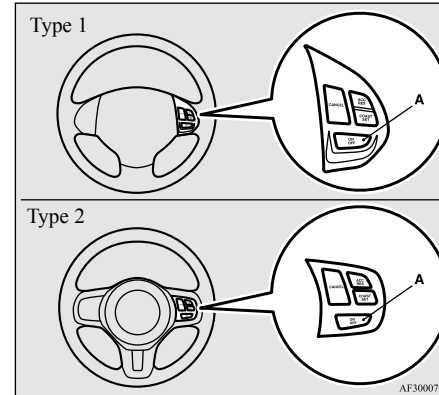

NOTE

- If the cruise control is on when the ignition switch is turned to "OFF" position, cruise control will turn on automatically and the "CRUISE" control indicator will illuminate the next time you start the engine.
- If the battery voltage is insufficient, the memory data for the cruise control will be erased. As a result, the "CRUISE" control indicator may not come on when you restart the engine. If this happens, press the "ON OFF" switch once again to activate the cruise control.

- Confirm that the Twin Clutch SST control mode is set to “Normal” (on vehicles with Twin Clutch SST). Refer to “Twin Clutch SST control mode” on page 5-74.

NOTE

- The cruising speed cannot be set when the Twin Clutch SST control mode is set to “Sport” mode.

- Accelerate or decelerate to your desired speed, then press and release the “COAST SET” switch (B) when the “CRUISE” indicator light is illuminated. The vehicle will then maintain the desired speed.

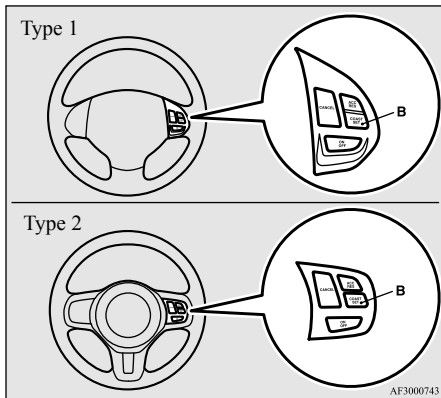

NOTE

- The speed when you released the “COAST SET” switch will be set as the cruising speed.

To increase the set speed

N00518500331

There are 2 ways to increase the set speed.

“ACC RES” switch

If you press and hold down the “ACC RES” switch (C), the speed will gradually increase. When you reach your desired speed, release the switch. Your cruising speed is now set.

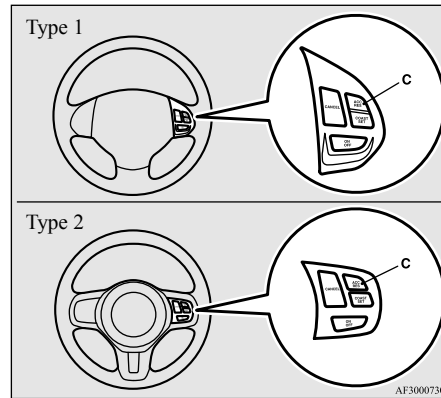

Cruise control (if so equipped)

To increase the speed in small amounts, press the “ACC RES” switch (C) for less than 1 second and release it. Every time you press the “ACC RES” switch (C), the speed will increase by approximately 1 mph (1.6 km/h).

Accelerator pedal

5

Use the accelerator pedal to reach your desired speed. Press the “COAST SET” switch (B) and release the switch momentarily to set a new desired cruising speed.

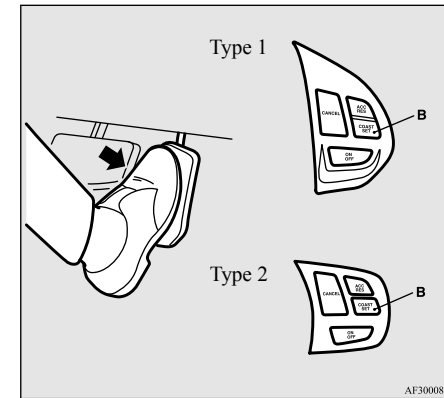

To decrease the set speed

N00518600260

There are 2 ways to reduce the set speed.

Cruise control (if so equipped)

“COAST SET” switch

Press and hold the “COAST SET” switch (B), the speed will slow down (coast) gradually. When you reach your desired speed, release the “COAST SET” switch. Your cruising speed is now set.

5

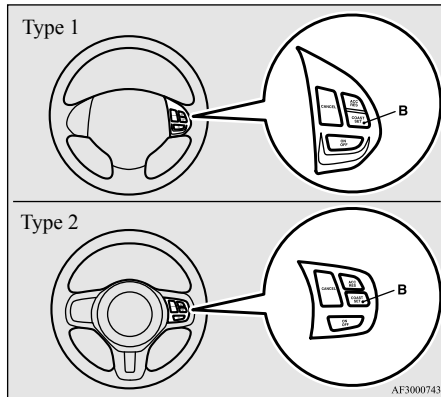

To decrease the speed in small amounts, press the “COAST SET” switch (B) for less than 1 second and release it. Every time you press the “COAST SET” switch (B), the speed will decrease by approximately 1 mph (1.6 km/h).

Brake pedal

Press the brake pedal (which disengages the cruise control) and when the desired speed is

reached, press the “COAST SET” switch (B) and release the switch momentarily to set a new desired cruise speed.

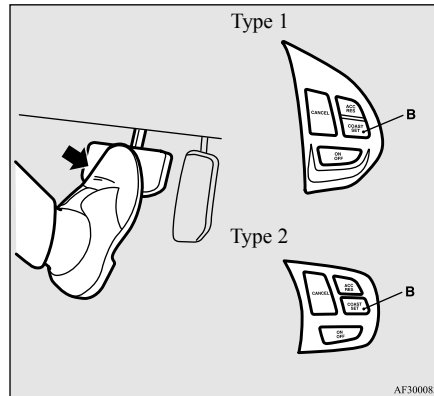

To temporarily increase or decrease the speed

N00518700128

To temporarily increase the speed

Press the accelerator pedal as you would normally. When you release the pedal, you will return to your set speed.

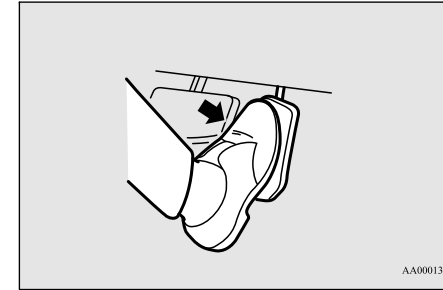

To temporarily decrease the speed

Apply the brakes to decrease the speed. To return to the previously set speed, press the “ACC RES” switch (C). Refer to “To resume the set speed” on page 5-102.

Cruise control (if so equipped)

Refer to “Active stability control (ASC)” on page 5-94.

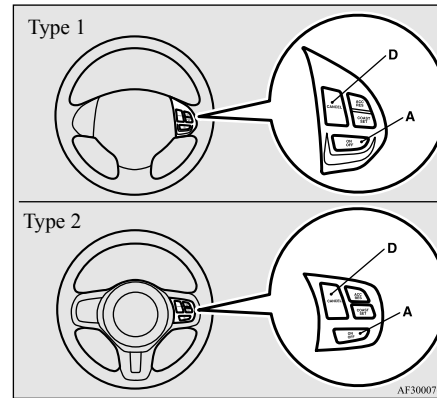
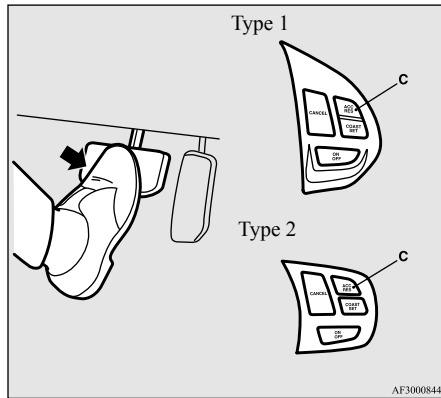

To deactivate

N00518800493

The cruise control can be turned off as follows:

- Press the “ON OFF” switch (A). (Cruise control will be turned off.)
- Press the “CANCEL” switch (D).
- Depress the brake pedal or lightly tap it.

The cruise control will be turned off automatically in the following conditions:

- When you depress the clutch pedal (on vehicles with manual transaxle).
- Your speed slows to about 10 mph (15 km/h) or more below the set speed because of an uphill, etc.
- Your speed slows to about 25 mph (40 km/h) or less.
- When the Twin Clutch SST control mode is set to “Sport” mode (on vehicles with Twin Clutch SST).
Refer to “Twin Clutch SST control mode” on page 5-74.
- When the active stability control (ASC) starts operating (if so equipped).

⚠ WARNING

- On vehicles with continuously variable transmission (CVT) or Twin Clutch SST, although the cruise control will be disengaged when shifting to the “N” (NEUTRAL) position, never move the selector lever (CVT) or the gearshift lever (Twin Clutch SST) to the “N” (NEUTRAL) position while driving.
You would have no engine braking and this could cause a serious accident.

Also, the set speed driving may be deactivated as follow:

- When the engine speed rises and approaches the tachometer’s red zone (the red-colored part of the tachometer dial).

⚠ CAUTION

- When the set speed driving is deactivated automatically in any situation other than those listed above, there may be a system malfunction.
Press the “ON OFF” switch to turn off the cruise control and have your vehicle inspected by an authorized Mitsubishi Motors dealer or a repair facility of your choice.

Tire pressure monitoring system

To resume the set speed

N00518900263

If the cruise control is deactivated by any of the conditions described in “To deactivate” on page 5-101, you can return to the previously set speed by pressing the “ACC RES” switch (C) while driving at a speed of approximately 25 mph (40 km/h) or greater.

5

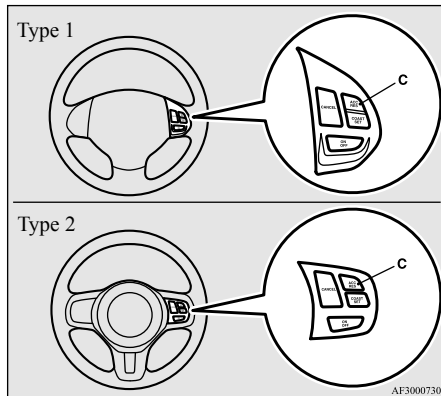

However, you must repeat the speed setting procedure under either of the following conditions:

- The ignition switch is turned to the “OFF” position.
- The cruise control is turned OFF.
- “CRUISE” indicator light is turned off.

5-102 Features and controls

Tire pressure monitoring system

N00530201494

The tire pressure monitoring system uses tire inflation pressure sensors (A) on the wheels to monitor the tire inflation pressures. The system only indicates when a tire is significantly under-inflated.

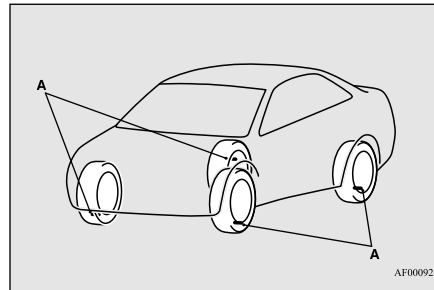

WARNING

- **The spare wheel does not have a tire inflation pressure sensor. When the spare tire is used, the tire pressure monitoring system will not work properly. See an authorized Mitsubishi Motors dealer as soon as possible to replace or repair the original tire.**

NOTE

- The tire pressure monitoring system is not a substitute for regularly checking tire inflation pressures. Be sure to check the tire inflation pressures as described in “Tires” on page 9-17.
 - The tire inflation pressure sensor (A) is installed in the illustrated location.
 - On vehicles with Type 1 sensor which has the metallic air valve (B), replace grommet (C) with a new one when the tire is replaced.
 - On vehicles with Type 2 sensor which has the rubber air valve (D), replace rubber valve (D) with new one when the tire is replaced.
- For details, please contact your authorized Mitsubishi Motors dealer.

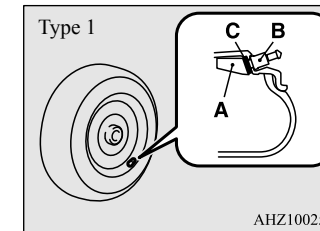

AHZ100251

Tire pressure monitoring system

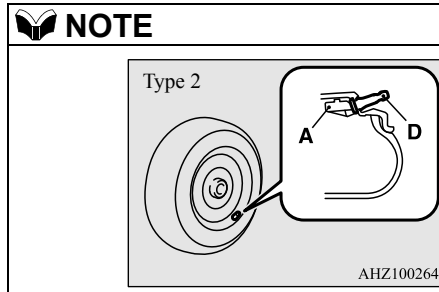

Tire pressure monitoring system warning light/display

N00532700122



When the ignition switch is turned to the “ON” position, the tire pressure monitoring system warning light normally illuminates and goes off a few seconds later.

If one or more of the vehicle tires (except for the spare tire) is significantly under-inflated, the warning light will remain illuminated while the ignition switch is in the “ON” position.

Refer to “If the warning light/display illuminates while driving” on page 5-104 and take the necessary measures.

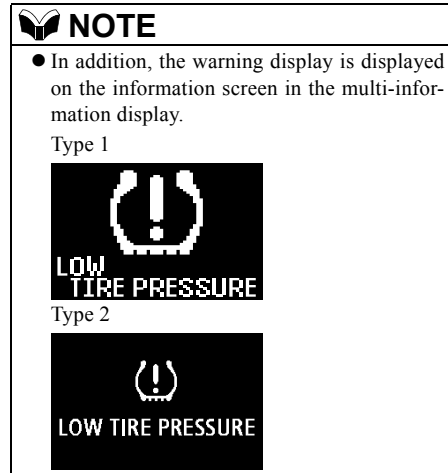

CAUTION

- If the tire pressure monitoring system warning light does not illuminate when the ignition switch is turned to the “ON” position, it means that the tire pressure monitoring system is not working properly. Have the system inspected by an authorized Mitsubishi Motors dealer. In such situations, a malfunctioning of the system may be preventing the monitoring of the tire pressure. Avoid sudden braking, sharp turning and high-speed driving.

CAUTION

- If a malfunction is detected in the tire pressure monitoring system, the tire pressure monitoring system warning light will blink for approximately 1 minute and then remain continuously illuminated. The warning light will issue further warnings each time the engine is restarted as long as the malfunction exists. Check to see whether the warning light goes off after few minutes driving. If it then goes off during driving, there is no problem. However, if the warning light does not go off, or if it blinks again when the engine is restarted, have the vehicle inspected by an authorized Mitsubishi Motors dealer. In such situations, a malfunctioning of the system may be preventing the monitoring of the tire pressure. For safety reasons, when the warning light appears while driving, avoid sudden braking, sharp turning and high-speed driving.

5

NOTE

- In addition, the warning display is displayed on the information screen in the multi-information display.

Tire pressure monitoring system

NOTE

Type 1



Type 2



Each tire, including the spare (if provided), should be checked monthly when cold and inflated to the inflation pressure recommended by the vehicle manufacturer on the vehicle placard or tire inflation pressure label. (If your vehicle has tires of a different size than the size indicated on the vehicle placard or tire inflation pressure label, you should determine the proper tire inflation pressure for those tires.)

As an added safety feature, your vehicle has been equipped with a tire pressure monitoring system (TPMS) that illuminates a low tire pressure telltale when one or more of your tires is significantly under-inflated.

Accordingly, when the low tire pressure telltale illuminates, you should stop and check your tires as soon as possible, and inflate them to the proper pressure. Driving on a sig-

5-104 Features and controls

nificantly under-inflated tire causes the tire to overheat and can lead to tire failure.

Under-inflation also reduces fuel efficiency and tire tread life, and may affect the vehicle's handling and stopping ability. Please note that the TPMS is not a substitute for proper tire maintenance, and it is the driver's responsibility to maintain correct tire pressure, even if under-inflation has not reached the level to trigger illumination of the TPMS low tire pressure telltale.

Your vehicle has also been equipped with a TPMS malfunction indicator to indicate when the system is not operating properly. The TPMS malfunction indicator is combined with the low tire pressure telltale.

When the system detects a malfunction, the telltale will flash for approximately one minute and then remain continuously illuminated. This sequence will continue upon subsequent vehicle start-ups as long as the malfunction exists.

When the malfunction indicator is illuminated, the system may not be able to detect or signal low tire pressure as intended.

TPMS malfunctions may occur for a variety of reasons, including the installation of replacement or alternate tires or wheels on the vehicle that prevent the TPMS from functioning properly. Always check the TPMS malfunction telltale after replacing one or more tires or wheels on your vehicle to ensure that

the replacement or alternate tires and wheels allow the TPMS to continue to function properly.

If the warning light/display illuminates while driving

N00532800439

1. If the tire pressure monitoring system warning light illuminates, avoid hard braking, sharp steering maneuvers and high speeds. You should stop and adjust the tires to the proper inflation pressure as soon as possible. Adjust the spare tire at the same time. Refer to "Tires" on page 9-17.

NOTE

- In addition, the warning display is displayed on the information screen in the multi-information display.
- When inspecting or adjusting the tire pressure, do not apply excessive force to the valve stem to avoid breakage.
- After inspecting or adjusting the tire pressure, always reinstall the valve cap on the valve stem. Without the valve cap, dirt or moisture could get into the valve, resulting in damage to the tire inflation pressure sensor.
- Do not use metal valve caps, which may cause a metal reaction, resulting in corrosion and damage of the tire inflation pressure sensors.

Tire pressure monitoring system

NOTE

- Once adjustments have been made, the warning light will go off after a few minutes of driving.

2. If the tire pressure monitoring system warning light remains illuminated after you have been driving for about 20 minutes after you adjust the tire inflation pressure, one or more of the tires may have a puncture. Inspect the tire and if it has a puncture, have it repaired by an authorized Mitsubishi Motors dealer as soon as possible.

WARNING

- **If the warning light/display illuminates while you are driving, avoid hard braking, sharp steering maneuvers and high speeds. Driving with an under-inflated tire adversely affects vehicle performance and can result in an accident.**

CAUTION

- If a tire has a puncture, replace that tire with the spare tire. Driving on a punctured tire could lead to an accident.
- The warning light/display may not illuminate immediately in the event of a tire blowout or rapid leak.

NOTE

- To avoid the risk of damage to the tire inflation pressure sensors, have any punctured tire repaired by an authorized Mitsubishi Motors dealer. If the tire repair is not done by an authorized Mitsubishi Motors dealer, it is not covered by your warranty.
- Do not use an aerosol puncture-repair product on any tire. Such a spray could damage the tire inflation pressure sensors. Have any puncture repaired by an authorized Mitsubishi Motors dealer.

The tire pressure monitoring system may not work normally in the following circumstances:

- A wireless facility or device using the same frequency is near the vehicle.
- Snow or ice is stuck inside the fenders and/or on the wheels.
- The tire inflation pressure sensor's battery is dead.
- Wheels other than Mitsubishi genuine wheels are being used.
- Wheels that are not fitted with tire inflation pressure sensors are being used.
- Wheels whose ID codes are not memorized by the vehicle are used.
- Compact spare tire is fitted on a road wheel.

- A window tint that affects the radio wave signals is installed.

NOTE

- Tire inflation pressures vary with the ambient temperature. If the vehicle is subjected to large variations in ambient temperature, the tire inflation pressures may be under-inflated (causing the warning light/display to come on) when the ambient temperature is relatively low. If the warning light/display comes on, adjust the tire inflation pressure.

5

Whenever the tires and wheels are replaced with new ones

N00532900179

If new wheels with new tire inflation pressure sensors are installed, their ID codes must be programmed into the tire pressure monitoring system. Have tire and wheel replacement performed by an authorized Mitsubishi Motors dealer to avoid the risk of damaging the tire inflation pressure sensors. If the wheel replacement is not done by an authorized Mitsubishi Motors dealer, it is not covered by your warranty.

Rear-view camera (if so equipped)

⚠ CAUTION

- The use of non-genuine wheels will prevent the proper fit of the tire inflation pressure sensors, resulting in air leakage or damage to the sensors.

5 General information

N00533001259

Your tire pressure monitoring system operates on a radio frequency subject to Federal Communications Commission (FCC) Rules (For vehicles sold in U.S.A.) and Industry Canada Rules (For vehicles sold in Canada). This device complies with Part 15 of FCC Rules and Industry Canada licence-exempt RSS standard(s).

Operation is subject to the following two conditions.

- This device may not cause harmful interference.
- This device must accept any interference received, including interference that may cause undesired operation.

⚠ CAUTION

- Changes or modifications not expressly approved by the manufacturer for compliance could void the user's authority to operate the equipment.

Rear-view camera (if so equipped)

N00546201154

When the gearshift lever or the selector lever is in the "R" (REVERSE) position with the ignition switch in the "ON" position, the rear-view image will be displayed on the screen of the Mitsubishi Multi-Communication System or the DISPLAY AUDIO in the center panel.

When the gearshift lever or the selector lever is shifted out of the "R" (REVERSE) position, the rear-view image will go off.

⚠ WARNING

- **Never rely solely on the rear-view camera to clear the area behind your vehicle. Always check visually behind and all around your vehicle for persons, animals, obstructions or other vehicles. Failure to do so can result in vehicle damage, serious injury or death.**
- **The rear-view camera is an aid system for backing up, but it is not a substitute for your visual confirmation.**
- **The view on the screen is limited, and objects outside the view, such as under the bumper or around either corner of the bumper end, cannot be seen on the screen.**

Location of rear-view camera

The rear-view camera (A) is built-in to the trunk lid.

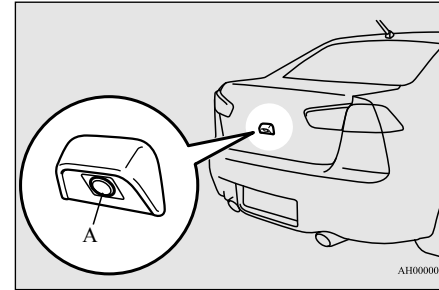

⚠ CAUTION

- If the camera lens gets dirty, a clear image cannot be obtained. As necessary, rinse the lens with clean water and gently wipe with a clean, soft cloth.
- To avoid damaging the camera;
 - Do not rub the cover excessively or polish it by using an abrasive compound.
 - Do not disassemble the camera.
 - Do not splash hot water directly on the lens.
 - Do not spray the camera and its surroundings with high-pressure water.
- Make sure that the trunk lid is securely closed when backing up.

Reference lines on the screen

Reference lines and upper surface of the rear bumper (A) are displayed on the screen.

- Red line (B) indicates approximately 20 inches (50 cm) behind the rear bumper.
- Two Green lines (C) indicate approximately 8 inches (20 cm) outside of the vehicle body.
- Short transverse lines (1 to 3) indicate distance from the rear bumper.

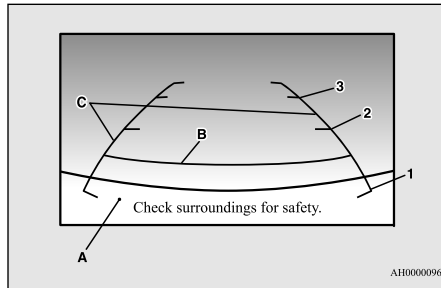

- 1: Approximately at the rear edge of the rear bumper
 2: Approximately 39 inches (100 cm)
 3: Approximately 79 inches (200 cm)

CAUTION

- The rear-view camera uses a wide-angle lens. As a result, images and distances shown on the screen are not exact.
- Actual distance may be different from distance indicated by the lines on the screen, depending on the loading condition of the vehicle and road surface condition. The reference lines for distance and vehicle width are based on a level, flat road surface. In the following cases, objects shown on the screen will appear to be farther off than they actually are.
 - When the rear of the vehicle is weighed down with the weight of passengers and luggage in the vehicle. (Case 1)
 - When there is an upward slope at the back. (Case 2)

Case 1

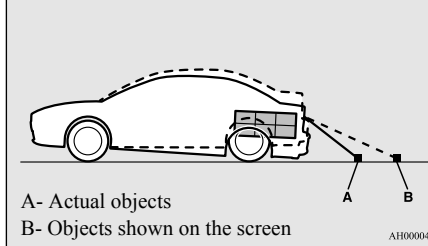

A- Actual objects
 B- Objects shown on the screen

Rear-view camera (if so equipped)

Case 2

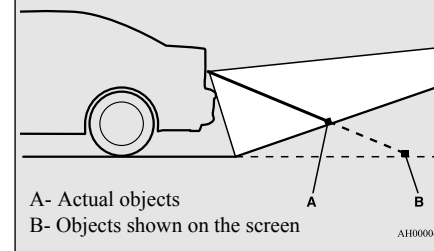

A- Actual objects
 B- Objects shown on the screen

5

CAUTION

- The reference lines for distance and vehicle width are intended to indicate the distance to a flat object such as a level, flat road surface. They may not indicate correct distance depending on the shape of an obstacle. For example, when there is an object behind the vehicle that has upper sections projecting in the direction of the vehicle, the reference lines on the screen will indicate that point A is the farthest point and point B is the closest point to the vehicle. In reality, point A and B are actually the same distance from the vehicle, and point C is farther off than point A and B.

Instrument cluster

5

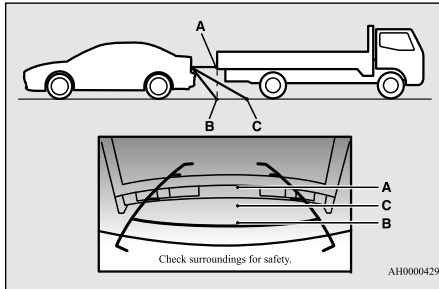

NOTE

- Monitor brightness is adjusted automatically by sensors.
- On vehicles equipped with Mitsubishi Multi-Communication System, it is possible to change the display language of the screen. For details, please refer to the separate owner's manual.
- Under certain circumstances, it may become difficult to see an image on the screen, even when the system is functioning correctly.
 - In a dark area, such as at night.
 - When water drops or condensation are on the lens.
 - When sun light or headlights shine directly into the lens.

Instrument cluster

N00519000333

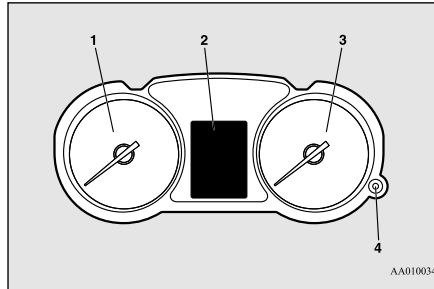

- 1- Tachometer →P.5-108
- 2- Multi-information display →P.5-110
Information screen display list →P.5-132
- 3- Speedometer →P.5-108
- 4- Rheostat meter illumination button →P.5-109

Speedometer

N00519100190

The speedometer shows the vehicle speed in miles per hour (mph) or kilometers per hour (km/h).

Type 1

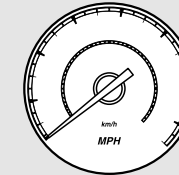

Type 2

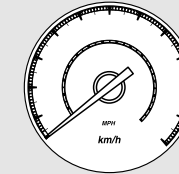

Tachometer

N00519200276

The tachometer shows engine revolutions per minute. This allows the driver to determine the most efficient shift position (manual transaxle), selector position {continuously variable transmission (CVT)} or shift posi-

tion (Twin Clutch SST) and engine speed combinations.
This gauge also assists in evaluating engine performance.

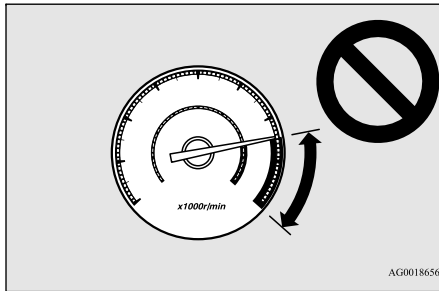

CAUTION

- The red zone indicates an engine speed beyond the range of safe operation.
- Select the correct shift position (manual transaxle), selector position (CVT) or gear-shift position (Twin Clutch SST) to control the engine speed so that the tachometer indicator does not enter the red zone.

Rheostat meter illumination button

N00554900137

Each time you press this button, there is a sound and the brightness of the instruments changes.

NOTE

- You can adjust to 8 different levels respectively for when the tail lights are illuminated and when they are not.
- If the vehicle is equipped with the automatic light control, when the light switch is in a position other than the “OFF” position, the meter illumination switches automatically to the adjusted brightness, depending on the brightness outside the vehicle.
- The brightness level of the instruments is stored in memory when the ignition switch is turned off.
- If you press and hold the button for longer than about 1 second when the parking lights are illuminated, the brightness level changes to the maximum level. Pressing and holding the button for longer than about 1 second again returns the brightness level to the previous level.

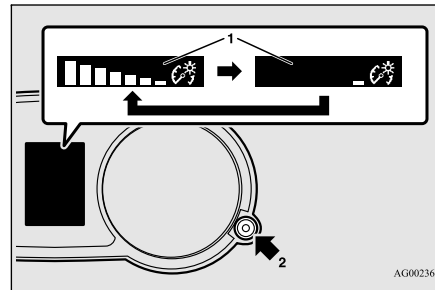

1- Brightness display

2- Rheostat illumination button

Multi-information display

Multi-information display

N0055001305

The multi-information display displays warnings, the odometer, trip odometer, service reminder, engine coolant temperature, fuel remaining, outside temperature, Twin Clutch SST control mode, ACD control mode, gearshift lever position, selector lever position, all-wheel drive operation status, average and momentary fuel consumption, driving range, average speed, instrument brightness, etc. It is also possible to change elements such as the language and units used on the multi-information display.

5

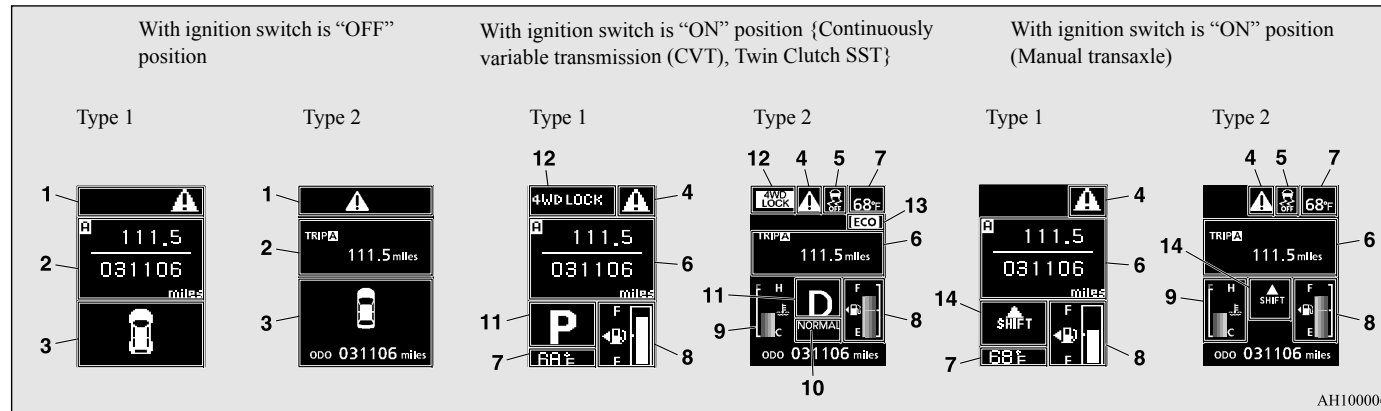

AH1000064

- 1- Warning display screen (With ignition switch in the "OFF" position) →P.5-111
- 2- Information screen (With ignition switch in the "OFF" position) →P.5-112
Interrupt display screen (With ignition switch in the "OFF" position) →P.5-113

- 3- Door ajar warning display screen (With ignition switch in the "OFF" position) →P.5-114
- 4- Warning display screen (With ignition switch in the "ON" position) →P.5-116
- 5- Active stability control (ASC) OFF display screen (if so equipped) →P.5-116

- 6- Information screen (With ignition switch in the "ON" position) →P.5-116
Interrupt display screen (With ignition switch in the "ON" position) →P.5-119
- 7- Outside temperature display screen →P.5-120
- 8- Fuel remaining display screen →P.5-121

5-110 Features and controls

- 9- Engine coolant temperature display (if so equipped) →P.5-116
- 10- Twin Clutch SST control mode display screen (Twin Clutch SST) →P.5-76
- 11- Selector lever position display screen (CVT) →P.5-64
Gearshift lever position display screen (Twin Clutch SST) →P.5-71
- 12- Drive mode indicator display screen (CVT) (if so equipped) → P.5-115
ACD control mode display screen (Twin Clutch SST) →P.5-82
- 13- ECO mode indicator (if so equipped) →P.5-121
- 14- Gearshift indicator display screen (if so equipped) →P.5-60

NOTE

- The fuel units, temperature units, display language, and other settings can be changed. Refer to “Changing the function settings (With ignition switch in the “ON” position)” on page 5-123.

NOTE

- The display screen is different depending on whether the ignition switch in the “OFF” or “ON” position.
Refer to “Information screen (With ignition switch in the “OFF” position)” on page 5-112.
Refer to “Warning display list (With ignition switch in the “OFF” position)” on page 5-132.
Refer to “Information screen (With ignition switch turned from “OFF” to “ON” position)” on page 5-115.
Refer to “Information screen (With ignition switch in the “ON” position)” on page 5-116.
Refer to “Warning display list (With ignition switch in the “ON” position)” on page 5-135.

Multi-information meter switch

N00555100136

The multi-information meter switch is a button marked “INFO” on the left side of the dash.

Each time the multi-information meter switch is operated, a sound is emitted and the multi-information display changes between information such as warnings, odometer, trip odometer, service reminder, engine coolant temperature (Type 1), average and momentary fuel consumption, driving range, and average speed and ACD control mode display (if so equipped).

Multi-information display

It is also possible to change elements such as the language and units used on the multi-information display by operating the multi-information meter switch.

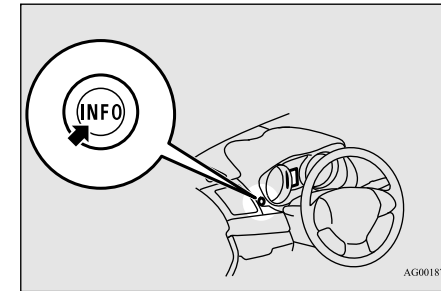

5

Warning display screen (With ignition switch in the “OFF” position)

N00555200137

If you press the multi-information meter switch and return from the warning display screen to the previous screen, the  warning is displayed.

Refer to “Returning to the display screen from before the warning display” on page 5-113.

This mark is also displayed if there is another warning other than the one displayed. When

Multi-information display

the cause of the warning display is eliminated, the  warning goes out automatically.

NOTE

- When the  warning is displayed, the warning display screen can be redisplayed on the information screen.
Refer to “Information screen (With ignition switch in the “OFF” position)” on page 5-112.
Refer to “Information screen (With ignition switch in the “ON” position)” on page 5-116.



5

Information screen (With ignition switch in the “OFF” position)

N0055300112

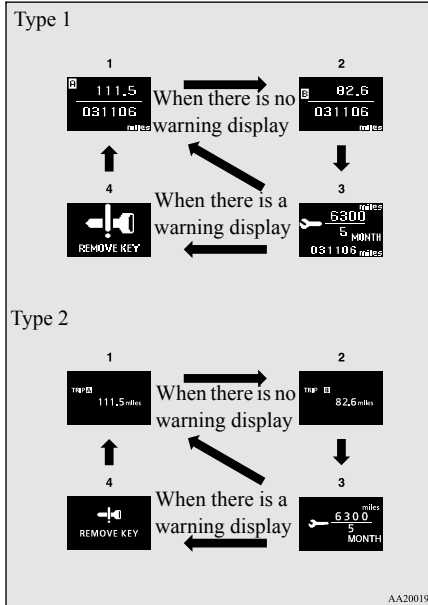
Each time you lightly press the multi-information meter switch, the display screen changes in the following order.





- 1- Odometer (Type 1), Trip odometer 
- 2- Odometer (Type 1), Trip odometer 
- 3- Service reminder
- 4- Redisplay of a warning display screen

Odometer/Trip odometer

N00555400100

Each time you lightly press the multi-information meter switch, the display screen changes as follows:



Odometer/Trip odometer  → Odometer/Trip odometer  → Service reminder → Redisplay of a warning display screen → Odometer/Trip odometer .

Odometer

Shows the total distance traveled.

Trip odometer

Shows the distance traveled between two points.

Usage examples for trip odometer , trip odometer .

Multi-information display

It is possible to measure two currently traveled distances, from home using trip odometer **A** and from a particular point on the way using trip odometer **B**.

To reset the trip odometer:

To return the display to 0, hold down the multi-information meter switch for about 2 seconds or more. Only the currently displayed value will be reset.

Example:

If trip odometer **A** is displayed, only trip odometer **A** will be reset.

Type 1

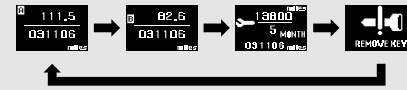

Type 2



AA2001979

NOTE

- If there is no warning display, the switching sequence is: Odometer/Trip odometer **A** → Odometer/Trip odometer **B** → service reminder → Odometer/Trip odometer **A**.

NOTE

- Both trip odometers **A** and **B** can count up to 9999.9 miles/kilometers. When a trip odometer goes past 9999.9 miles/kilometers, it returns to 0.0 miles/kilometers.
- When the battery is disconnected, the memories of trip odometer displays **A** and **B** are cleared, and their displays return to “0.0 miles/kilometers”.

5

Service reminder

N0055500039

Shows the distance and number of months until the next periodic inspection. Refer to “Service reminder” on page 5-121.

Interrupt display screen (With ignition switch in the “OFF” position)

N00559600155

When there is information to be announced, such as a key reminder, the buzzer sounds and switches to the warning display screen. Refer to the appropriate page and take the necessary measures.

When the cause of the warning display is eliminated, the warning display goes out automatically.

Multi-information display

Refer to “Warning display list (With ignition switch in the “OFF” position)” on page 5-132.

5

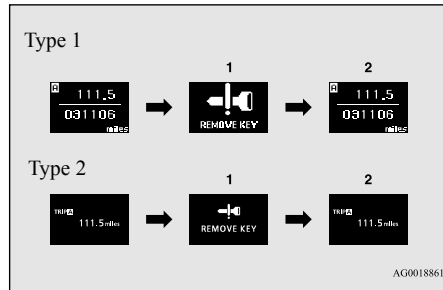

- 1- Information generated
- 2- Cause eliminated

Returning to the display screen from before the warning display

Even if the cause of the warning display is not eliminated, you can return to the screen that was displayed before the warning display.

If you press the multi-information meter switch, the display screen switches to the screen display from before the warning and the **A** warning (A) is displayed.

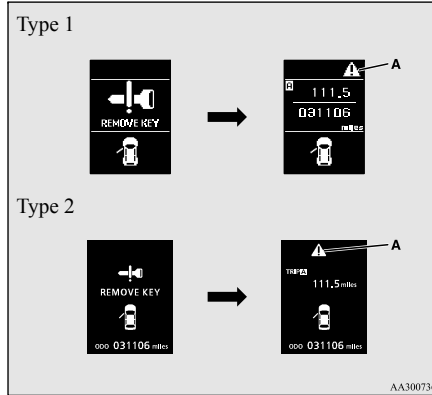

NOTE

- Warning display screens with a **A** or **B** mark displayed in the upper right of the screen can be switched. If you want to switch the display, press the multi-information meter switch as follows.
 - A**: Press lightly.
 - B**: Press for about 2 seconds or more.

Redisplay of a warning display screen

When the **A** warning is displayed, if you lightly press the multi-information meter switch a few times, the warning display screen you switched from is redisplayed.

Refer to “Information screen (With ignition switch in the “OFF” position)” on page 5-112.

Door ajar warning display (With ignition switch in the “OFF” position)

N00559700130

If any of the doors or the trunk lid is not completely closed, the open door or open trunk lid warning is displayed.

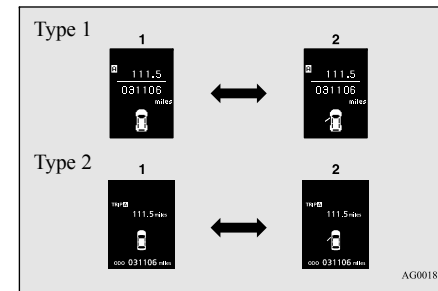

- 1- Doors and trunk lid are closed
- 2- Doors or trunk lid is open (driver’s door is open in this example)

Multi-information display

Information screen (With ignition switch turned from “OFF” to “ON” position)

N00555800133

When the ignition switch is turned to the “ON” position, the display screen changes in the following order.

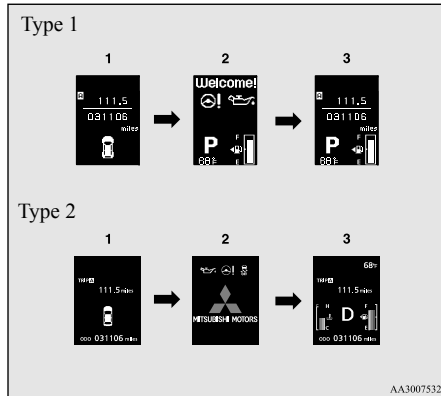

- 1- Screen when the ignition switch is “OFF”
- 2- System check screen
- 3- Screen when the ignition switch is “ON”

System check screen

When the ignition switch is turned to the “ON” position, the system check screen is displayed for about 4 seconds. If there is no fault, information screen (when the ignition switch is “ON”) is displayed.

If there is a fault, the screen changes to warning display. Refer to “Warning display list (when the ignition switch is “ON” position)” on page 5-135.

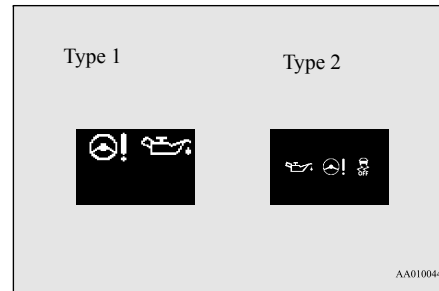

NOTE

- The system check screen display varies depending on your equipment.

Service reminder

When the time for periodic inspection arrives, the warning display is displayed for a few seconds after the screen that is initially displayed when the ignition switch is turned “ON”. Refer to “Service reminder” on page 5-121.

Type 1



Type 2



Drive mode indicator display screen (if so equipped)

N00555900046

Shows the 4WD drive status. Refer to “Drive mode-selector” on page 5-84.

Multi-information display

ACD control mode display screen (if so equipped)

N00545900027

The operation status of the ACD control mode is displayed. Refer to “ACD control mode” on page 5-82.

5

A Warning display screen (With ignition switch in the “ON” position)

N00555200140

This is displayed when you press the multi-information meter switch and switch the warning display screen.

This mark is also displayed if there is another warning other than the one displayed.

When the cause of the warning display is eliminated, the **A** warning goes out automatically.

NOTE

- When the **A** warning is displayed, the warning display screen can be redisplayed on the information screen. Refer to “Information screen (With ignition switch in the “OFF” position)” on page 5-112 or “Information screen (With ignition switch in the “ON” position)” on page 5-116.

5-116 Features and controls

“Active stability control (ASC) OFF” display screen (if so equipped)

N00556100074

This is displayed when the Active stability control (ASC) is turned “OFF” with the “ASC OFF” switch.

Also, if an abnormal condition is occurred in the ASC while driving, the “ASC OFF” display illuminates.

Refer to “ASC OFF switch” on page 5-94.

Information screen (With ignition switch in the “ON” position)

N00556200176

Each time you lightly press the multi-information meter switch, the display screen changes in the following order.

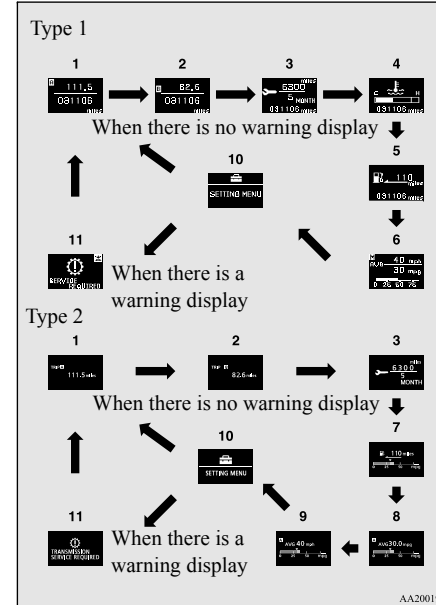

- 1- Odometer (Type 1)/Trip odometer **A**
- 2- Odometer (Type 1)/Trip odometer **B**
- 3- Service reminder
- 4- Engine coolant temperature display (Type 1)
- 5- Driving range display (Type 1)
- 6- Average speed display, average fuel consumption display, momentary fuel consumption display (Type 1)
- 7- Driving range display, momentary fuel consumption display (Type 2)

Multi-information display

- 8- Average fuel consumption display, momentary fuel consumption display (Type 2)
- 9- Average speed display, momentary fuel consumption display (Type 2)
- 10- Function setting screen
- 11- Redisplay of a warning display screen

NOTE

- While driving, the function setting screen is not displayed even if you operate the multi-information meter switch. Always park the vehicle in a safe place before operating. Refer to “Changing the function settings (With ignition switch in the “ON” position)” on page 5-123.
- When there is information to be announced, such as a system fault, the tone sounds and the screen display is changed. Refer to “Interrupt display screen (With ignition switch in the “ON” position)” on page 5-119.

Service reminder

Shows the distance and number of months until the next periodic inspection. Refer to “Service reminder” on page 5-121.

Engine coolant temperature display

Shows the engine coolant temperature.

If the coolant becomes hot,  will blink. Pay careful attention to the engine coolant temperature display while you are driving.

CAUTION

- If the engine is overheating,  will blink. In this case, the bar graph is on the red zone. Immediately park the vehicle in a safe place and take the required measures. Refer to “Engine overheating” on page 8-4.

NOTE

- The driving range is determined based on the fuel consumption data. This may vary depending on the driving conditions and habits. Treat the distance displayed as just a rough guideline.
- When you refuel, the driving range display is automatically updated. However, if you only add a small amount of fuel, the correct value will not be displayed. Fill to a full tank whenever possible.
- When your vehicle is stopped on an extremely steep hill, the driving range value may change. This is due to the movement of fuel in the tank and does not indicate any problem.
- The display setting can be changed to the preferred units (miles or km). Refer to “Changing the function settings (With ignition switch in the “ON” position)” on page 5-123.

5

Odometer/Trip odometer

The operation method is the same as when the ignition switch is in the “OFF” position. For further details, refer to “Odometer/Trip odometer” on page 5-112.

Driving range display

Shows the approximate driving range (how many more miles or kilometers you can drive) with the current fuel level. When this driving range falls below 30 miles (50 km), “--” is displayed. Refuel as soon as possible.

Average speed display

This displays the average speed from the last reset to the present. There are 2 types of mode settings as follows. For details on how to change the average speed display setting, refer to “Changing the function settings (With ignition switch in the “ON” position)” on page 5-123.

Features and controls 5-117

Multi-information display

Manual reset mode

- When the average speed is being displayed, if you hold down the multi-information meter switch, the average speed displayed at that time is reset.
- When the ignition switch is turned to the “ON” position from the “ACC” or “LOCK” position, the mode setting changes automatically from manual to auto. Switching to auto occurs automatically. If switching to manual mode is done, however, the data from the last reset is displayed.

5

Auto reset mode

- When the average speed is being displayed, if you hold down the multi-information meter switch, these calculations will be reset to zero.
- When the ignition switch has been set to the “ACC” or “LOCK” position for about 4 hours or more, the average speed display will automatically reset.

NOTE

- The average speed display and the average fuel consumption display can be reset separately in both auto reset mode and manual reset mode.

5-118 Features and controls

NOTE

- “---” is displayed when the average speed cannot be measured.
- The initial (default) setting is “Auto reset mode”.
- The display setting can be changed to the preferred units (mph or km/h). Refer to “Changing the function settings (With ignition switch in the “ON” position)” on page 5-123.
- The average speed display memories for auto reset mode and manual reset mode are erased if the battery is disconnected.

Average fuel consumption display

This displays the average fuel consumption from the last reset to the present.

There are 2 types of mode settings as follows. For details on how to change the average fuel consumption display setting, refer to “Changing the function settings (With ignition switch in the “ON” position)” on page 5-123.

The “” mark in the momentary fuel gauge shows the average fuel consumption. (Type 2)

Manual reset mode

- When the average fuel consumption is being displayed, if you hold down the multi-information meter switch, the average fuel consumption displayed at that time is reset.
- When the ignition switch is turned to the “ON” position from the “ACC” or “LOCK” position, the mode setting changes automatically from manual to auto. Switching to auto occurs automatically. If switching to manual mode is done, however, the data from the last reset is displayed.

Auto reset mode

- When the average fuel consumption is being displayed, if you hold down the multi-information meter switch, these calculations will be reset to zero.
- When the ignition switch has been set to the “ACC” or “LOCK” position for about 4 hours or more, the average speed display will automatically reset.

Multi-information display

NOTE

- The average speed display and the average fuel consumption display can be reset separately in both auto reset mode and manual reset mode.
- “---” is displayed when the average fuel consumption cannot be measured.
- The initial (default) setting is “Auto reset mode”.
- Average fuel consumption may vary depend on the driving conditions (road conditions, how you drive, etc.) The actual fuel consumption may differ from the fuel consumption displayed, so treat the fuel consumption displayed as just a rough guideline.
- The average fuel consumption display memories for auto reset mode and manual reset mode are erased if the battery is disconnected.
- The display setting can be changed to the preferred units {mpg (US), mpg (UK), L/100 km or km/L}.
Refer to “Changing the function settings (With ignition switch in the “ON” position)” on page 5-123.

Momentary fuel consumption display

While driving, the momentary fuel consumption is shown with a bar graph.

When the momentary fuel consumption surpasses the average fuel consumption, the momentary fuel consumption is displayed with a green bar graph. (Type 2)

Be conscious of maintaining the momentary fuel consumption above the average fuel consumption, it can help you drive with the better fuel consumption.

NOTE

- When the momentary fuel consumption cannot be measured, a bar graph is not shown.
- The display setting can be changed to the preferred units {mpg (US), mpg (UK), L/100 km or km/L}.
Refer to “Changing the function settings (With ignition switch in the “ON” position)” on page 5-123.
- It is possible to cancel the green bar graph.
Refer to “Changing the function settings (With ignition switch in the “ON” position)” on page 5-123.

Function setting screen

The “Display language”, “Temperature unit”, “Fuel consumption unit”, and “Average fuel consumption and speed reset method” settings can be modified as desired.

For further details, refer to “Changing the function settings (With ignition switch in the “ON” position)” on page 5-123.

Interrupt display screen (With ignition switch in the “ON” position)

N00556300135

Warning display**5**

When there is information to be announced, such as a system fault, a tone sounds and the information screen is switched to the warning display screen.

Refer to the warning list and take the necessary measures. Refer to “Warning display list (With ignition switch in the “ON” position)” on page 5-135.

When the cause of the warning display is eliminated, the warning display goes out automatically.

Returning to the display screen from before the warning display

Even if the cause of the warning display is not eliminated, you can return to the screen that was displayed before the warning display.

If you press the multi-information meter switch, the display screen switches to the screen display from before the warning and the  warning (A) is displayed.

Multi-information display

5

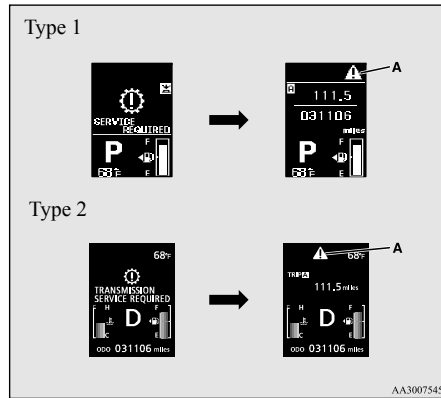

NOTE

- Warning display screens with a “” or “” mark displayed in the upper right of the screen can be switched. If you want to switch the display, press the multi-information meter switch as follows.
 - “” : Press lightly.
 - “” : Press for about 2 seconds or more.

Redisplay of a warning display screen

When the warning is displayed, if you lightly press the multi-information meter

5-120 Features and controls

switch a few times, the warning display screen you switched from is redisplayed.

Other interrupt displays

The operation status of each system is displayed on the information screen. For further details, refer to the appropriate page in the warning display list. Refer to “Other interrupt displays (With ignition switch in the “ON” position)” on page 5-141.

Selector lever position display screen {continuously variable transmission (CVT)}

N0055640048

Shows the position of the selector lever. Refer to “Selector lever operation” on page 5-61.

Gearshift lever position display screen (Twin Clutch SST)

N0054580055

Shows the position of the gearshift lever. Refer to “Gearshift lever operation” on page 5-70.

Outside temperature display screen

N0055650094

Shows the temperature outside the vehicle.

NOTE

- The display setting can be changed to the preferred units (°F or °C). Refer to “Changing the function settings (With ignition switch in the “ON” position)” on page 5-123.
- Depending on factors such as the driving conditions, the displayed temperature may vary from the actual outside temperature.

Twin Clutch SST control mode display screen (Twin Clutch SST)

N0054510029

The operation status of the Twin Clutch SST control mode is displayed. Refer to “Twin Clutch SST control mode” on page 5-74.

ACD control mode display screen (if so equipped)

N0054590030

The operation status of the ACD control mode is displayed.

Refer to “ACD control mode” on page 5-82.

ECO mode indicator (if so equipped)

N00568700019

This indicator will be displayed when fuel-efficient driving is achieved.

Fuel remaining display screen

N00556600125

Shows the amount of fuel remaining.

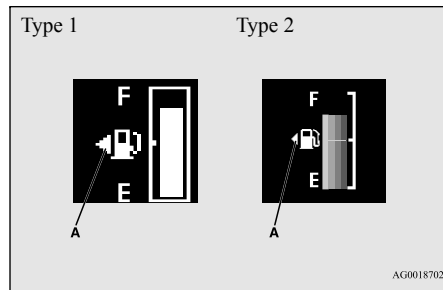

CAUTION

- Running out of gas could damage the catalytic converter. If the warning display appears, refuel as soon as possible.

NOTE

- It may take several seconds to stabilize the display after refilling the tank.
- If fuel is added with the ignition switch in the “ON” position, the remaining fuel display may indicate an incorrect fuel level.

Fuel tank filler door mark

The arrow (A) indicates that the fuel tank filler door is located on the left side of the vehicle. (Refer to “Filling the fuel tank” on page 3-4.)

Fuel remaining warning display

When the fuel level runs low, the information screen changes to the interrupt display of the fuel remaining warning display and the mark (B) on the fuel remaining display flashes slowly. If this warning display appears, refuel as soon as possible.

Multi-information display

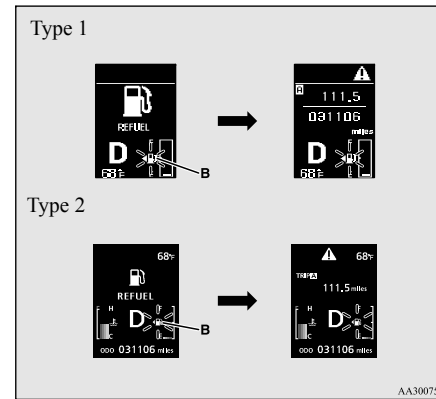

5

NOTE

- On hills or curves, the display may be incorrect due to the movement of fuel in the tank.

Service reminder

N00556700168

Displays the approximate time until the next recommended periodic inspection. “---” is displayed when the inspection time has arrived.

NOTE

- Except for vehicles with Twin Clutch SST, shows the time until the periodic inspection every 6 months (7,500 miles or 12,000 km).

Multi-information display

5

NOTE

- For vehicles with Twin Clutch SST, the service reminder time can be modified by an authorized Mitsubishi Motors dealer, to adjust for severe usage, etc. Refer to “Severe maintenance schedule” in your vehicle’s Warranty and Maintenance Manual. For further information, please contact your authorized Mitsubishi Motors dealer.

Type 1

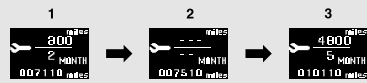

Type 2



AG0018917

- Shows the time until the next periodic inspection.

NOTE

- Shows the distance in units of 100 miles (100 km) and the time in units of 1 month.

- This informs you that a periodic inspection is due. Contact an authorized Mitsubishi Motors dealer or a repair facility of your choice to have the system checked.

At that time, when the ignition switch is switched from the “OFF” position to the “ON” position, the warning display is displayed for a few seconds on the information screen.

Type 1



Type 2



- After your vehicle is inspected at an authorized Mitsubishi Motors dealer, it displays the time until the next periodic inspection.

To reset

The “---” display can be reset while the ignition switch is in the “OFF” position. When the display is reset, the time until the next periodic inspection is displayed and the warning display is no longer displayed when the ignition switch is switched from the “OFF” position to the “ON” position.

- When you lightly press the multi-information meter switch, the information screen changes to the service reminder display screen.

Type 1

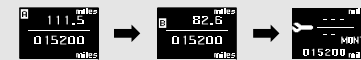

Type 2



AA3007402

Multi-information display

- Press and hold the multi-information meter switch (for about 2 seconds or more) to display “” and make it flash. (If there is no operation for about 10 seconds with this indicator flashing, the display returns to the previous screen.)
- With this indicator flashing, if you lightly press the multi-information meter switch, the screen switches from “---” to “CLEAR”. After that, the time until the next periodic inspection is shown.

CAUTION

- The customer is responsible for making sure that regular inspections and maintenance and periodic inspections and maintenance are performed. Inspections and maintenance must be performed to prevent accidents and malfunctions.

NOTE

- The “---” display cannot be reset while the ignition switch is in the “ON” position.
- When “---” is displayed, after a certain distance and a certain period of time, the display is reset and the time until the next periodic inspection is displayed.
- If you accidentally reset the display, consult an authorized Mitsubishi Motors dealer for assistance.

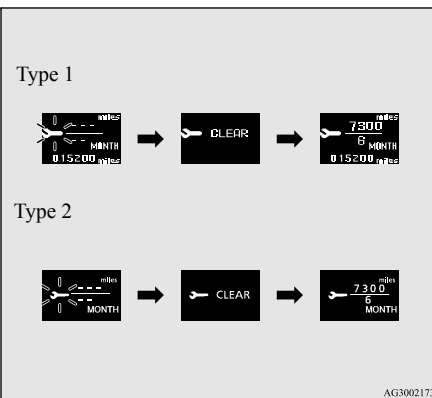

sound 4 times to inform you that a door is ajar. The buzzer will not sound if only the trunk lid is open.

Type 1



5

Type 2



CAUTION

- Always make sure that the warning display goes out before beginning to drive.

Door ajar warning display (With ignition switch in the “ON” position)

N00555700145

If any of the doors or the trunk lid is not completely closed, this displays the open door or trunk lid.

If the speed increases to about 5 mph (8 km/h) or higher with a door ajar, a buzzer will

Changing the function settings (With ignition switch in the “ON” position)

N00556801153

- Park your vehicle in a safe place.

Multi-information display

5

Fully apply the parking brake and move the shift lever into the “N” position (manual transaxle), the selector lever {continuously variable transmission (CVT)} or the gearshift lever (Twin Clutch SST) into the “P” position.

- When you lightly press the multi-information meter switch, the information screen changes to the function setting screen. Refer to “Information screen (With ignition switch in the “ON” position)” on page 5-116.

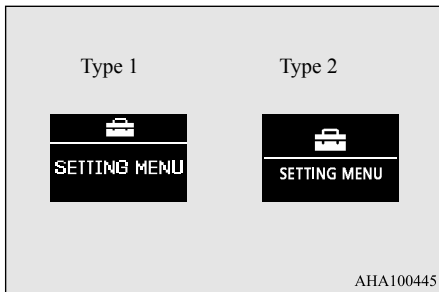

CAUTION

- For safety, stop the vehicle before operating. While driving, even if you operate the multi-information meter switch, the function setting screen is not displayed.

- Press and hold the multi-information meter switch (for about 2 seconds or more) to switch from the setting mode screen to the menu screen.

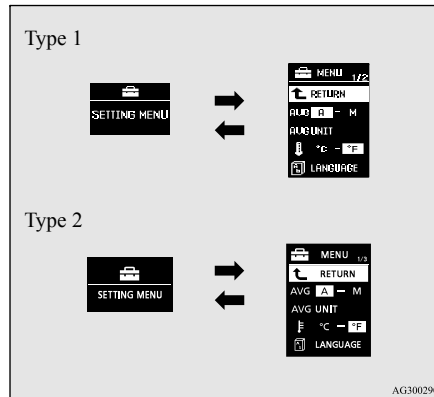

NOTE

- To return the menu screen to the function setting screen, press and hold the multi-information meter switch (for about 2 seconds or more).
- If no operations are made within about 15 seconds of the menu screen being displayed, the display returns to the function setting screen.

- Select the item to change on the menu screen and change to the desired setting. For further details on the operation methods, refer to the following sections.

Refer to “Changing the reset mode for average fuel consumption and average speed” on page 5-125.

Refer to “Changing the fuel consumption display unit” on page 5-125.

Refer to “Changing the temperature unit” on page 5-126.

Refer to “Changing the display language” on page 5-127.

Refer to “Operation sound setting” on page 5-127.

Refer to “Changing the amount of time until “REST REMINDER” is displayed” on page 5-128.

Refer to “Changing the turn signal sound” on page 5-129.

Refer to “Changing the momentary fuel consumption display (Type 2)” on page 5-129.

Refer to “Returning to the factory settings” on page 5-129.

Changing the reset mode for average fuel consumption and average speed

N00557000184

You can change the mode condition for the average fuel consumption and average speed display to “Auto reset” or “Manual reset”.

1. Press and hold the multi-information meter switch (for about 2 seconds or more) to switch from the setting mode screen to the menu screen.
Refer to “Changing the function settings (With ignition switch in the “ON” position)” on page 5-123.
2. Lightly press the multi-information meter switch to select “AVG” (average fuel consumption and average speed setting).

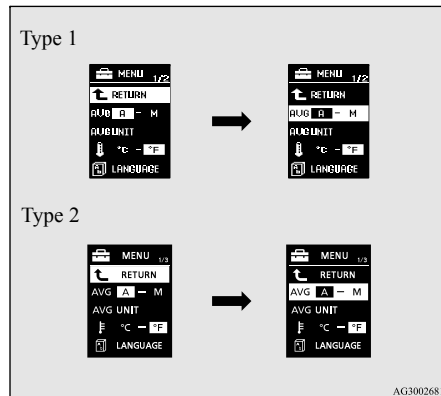

3. Press and hold the multi-information meter switch (for about 2 seconds or more) to switch in sequence from A or 1 (Auto reset mode) →M, 2 or P (Manual reset mode) →A or 1 (Auto reset mode). The setting will change to the selected mode condition.

Manual reset mode

- If you press and hold the multi-information meter switch when the average fuel consumption and average speed are displayed, these calculations will be reset to zero.
- When the ignition switch is turned to the “ON” position from the “ACC” or “LOCK” position, the mode setting changes automatically from manual to auto.

Switching to auto occurs automatically. If switching to manual mode is done, however, the data from the last reset is displayed.

Auto reset mode

- When the average fuel consumption and average speed are being displayed, if you hold down the multi-information meter switch, these calculations will be reset to zero.

Multi-information display

- When the ignition switch has been set to the “ACC” or “LOCK” position for about 4 hours or more, the average fuel consumption display and the average speed display will automatically reset.

NOTE

- The average speed display and average fuel consumption display can be reset separately in both auto reset mode and manual reset mode.
- The average speed display memories and average fuel consumption memories for auto reset mode and manual reset mode are erased if the battery is disconnected.
- The initial (default) setting is “Auto reset mode”.

5

Changing the fuel consumption display unit

N00557100130

The fuel consumption display unit can be changed. The distance, speed, and amount units are also changed to match the selected fuel consumption unit.

1. Press and hold the multi-information meter switch (for about 2 seconds or more) to change from the setting mode screen to the menu screen.

Multi-information display

Refer to “Changing the function settings (With ignition switch in the “ON” position)” on page 5-123.

- Lightly press the multi-information meter switch to select “AVG UNIT” (fuel consumption display unit setting).

5

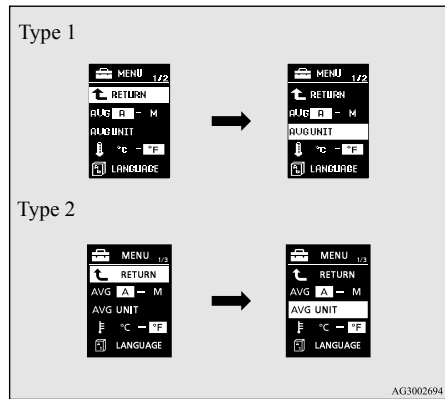

- Press and hold the multi-information meter switch (for about 2 seconds or more) to display “AVG UNIT” (fuel consumption display unit setting).
- Lightly press the multi-information meter switch to switch in sequence from km/L → L/100 km → mpg (US) → mpg (UK) → RETURN → km/L.

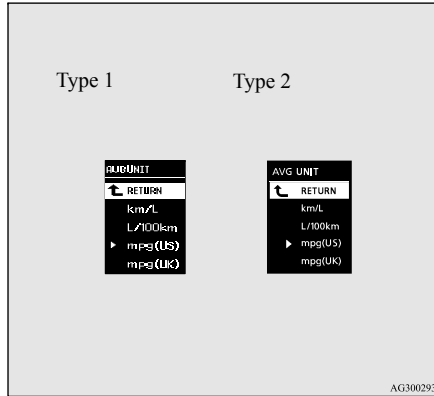

- Press and hold the multi-information meter switch (for about 2 seconds or more) to change the setting to the selected unit.

NOTE

- The display units for the driving range, the average fuel consumption, the average speed and the momentary fuel consumption are changed, but the units for the indicating needle (speedometer), the odometer and the trip odometer will remain unchanged.
- If the battery is disconnected, the memory of the unit setting is erased and is automatically set to {mpg (US) or L/100 km}.

The distance and speed units are also changed in the following combinations to match the selected fuel consumption unit.

Fuel economy	Distance (driving range)	Speed (average speed)
mpg (US)	mile (s)	mph
mpg (UK)	mile (s)	mph
km /L	km	km /h
L /100 km	km	km /h

Changing the temperature unit

N00557200102

The temperature display unit can be changed.

- Press and hold the multi-information meter switch (for about 2 seconds or more) to change from the setting mode screen to the menu screen. Refer to “Changing the function settings (With ignition switch in the “ON” position)” on page 5-123.
- Lightly press the multi-information meter switch to select “” (temperature unit setting).

Multi-information display

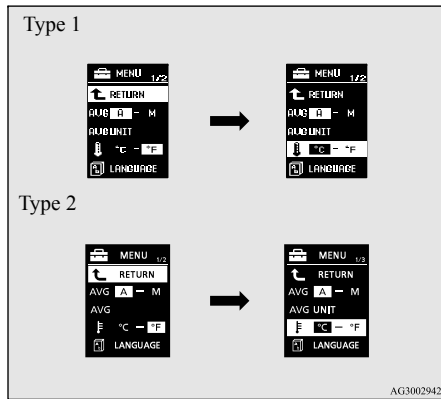

3. Press and hold the multi-information meter switch (for about 2 seconds or more) to change in sequence from °F → °C → °F.
The setting is changed to the selected temperature unit.

NOTE

- If the battery is disconnected, the memory of the unit setting is erased and is automatically set to °F (°C).

Changing the display language

N00557300145

The language of the multi-information display can be changed.

1. Press and hold the multi-information meter switch (for about 2 seconds or more) to change from the setting mode screen to the menu screen.
Refer to “Changing the function settings (With ignition switch in the “ON” position)” on page 5-123.
2. Lightly press the multi-information meter switch to select “LANGUAGE” (language setting).

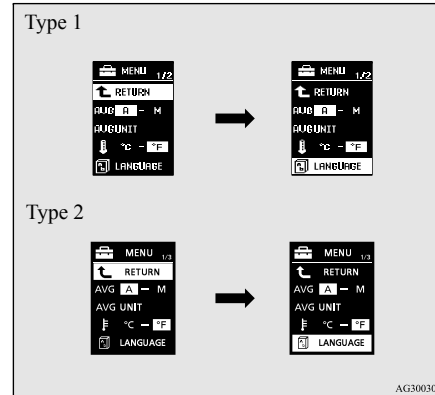

3. Press and hold the multi-information meter switch (for about 2 seconds or more) to display “LANGUAGE” (language setting).
4. Lightly press the multi-information meter switch to select the desired language.

5. Press and hold the multi-information meter switch (for about 2 seconds or more) to change the setting to the selected language.

NOTE

- If the battery is disconnected, the memory of the language setting is erased and is automatically set to ENGLISH.
- If “---” is selected in the language setting, a warning message is not displayed when there is a warning display or interrupt display.

5

Operation sound setting

N00557400104

You can turn off the operation sounds of the multi-information meter switch and rheostat meter illumination button.

1. Press and hold the multi-information meter switch (for about 2 seconds or more) to switch from the setting mode screen to the menu screen.
Refer to “Changing the function settings (With ignition switch in the “ON” position)” on page 5-123.
2. Lightly press the multi-information meter switch to select “” (operation sound setting).

Multi-information display

5

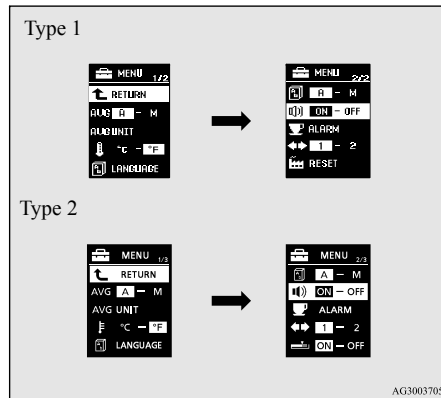

3. Press and hold the multi-information meter switch (for about 2 seconds or more) to switch in sequence from ON (operation sound on) → OFF (operation sound off) → ON (operation sound on). The setting is changed to the selected condition.

NOTE

- If the battery is disconnected, the memory of the operation sound setting is erased and is automatically set to “ON” (operation sound on).
- The operation sound setting only deactivates the operation sound of the multi-information meter switch and rheostat meter illumination button. The warning display and other sounds cannot be deactivated.

Changing the amount of time until “REST REMINDER” is displayed

N00557500121

The amount of time until the display appears can be changed.

1. Press and hold the multi-information meter switch (for about 2 seconds or more) to switch from the setting mode screen to the menu screen. Refer to “Changing the function settings (With ignition switch in the “ON” position)” on page 5-123.
2. Lightly press the multi-information meter switch to select “ALARM” (rest time setting).

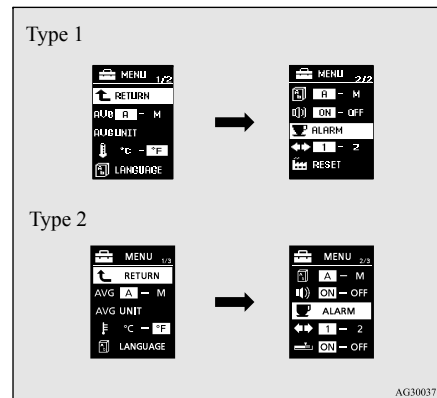

3. Press and hold the multi-information meter switch (for about 2 seconds or more) to display “ALARM” (rest time setting).

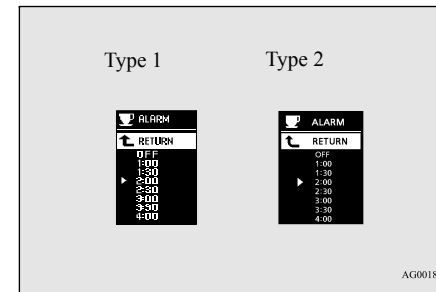

4. Lightly press the multi-information meter switch to select the amount of time until the display appears.
5. Press and hold the multi-information meter switch (for about 2 seconds or more) to change the setting to the selected time.

NOTE

- If the battery is disconnected, the memory of the unit setting is erased and is automatically set to the “OFF”.
- The drive time is reset when the ignition switch is in the “OFF” position.

Changing the turn signal sound

N00563500038

It is possible to change the turn signal sound.

1. Press and hold the multi-information meter switch for about 2 seconds or more to switch from the setting mode screen to the menu screen.

Refer to “Changing the function settings (With ignition switch in the “ON” position)” on page 5-123.

2. Lightly press the multi-information meter switch to select  (changing the turn signal sound)

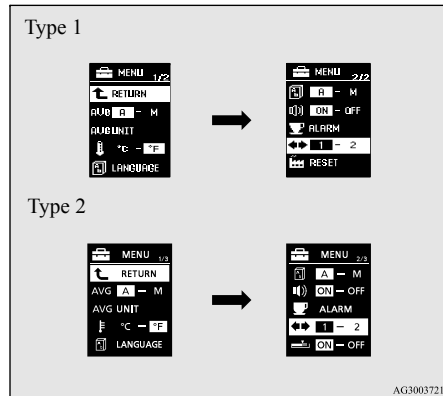

3. Press and hold the multi-information meter switch for about 2 seconds or more to switch in sequence from 1 (turn signal sound 1) → 2 (turn signal sound 2) → 1 (turn signal sound 1).

The setting changes to the selected turn signal sound.

Changing the momentary fuel consumption display (Type 2)

N00563600013

It is possible to change the bar graph setting of the momentary fuel consumption display.

1. Press and hold the multi-information meter switch for about 2 seconds or more to switch from the setting mode screen to the menu screen.

Refer to “Changing the function settings (With ignition switch in the “ON” position)” on page 5-123.

2. Lightly press the multi-information meter switch to select  (changing the momentary fuel consumption display)

Multi-information display

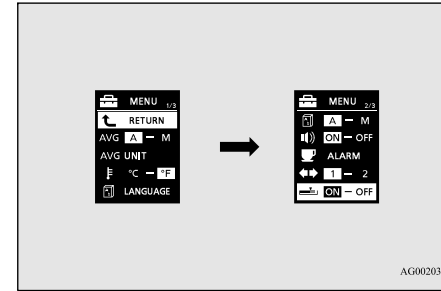

5

3. Press and hold the multi-information meter switch for about 2 seconds or more to switch in sequence from ON (with the green bar graph) → OFF (without the green bar graph) → ON (with the green bar graph).

The setting changes to the selected bar graph setting.

Returning to the factory settings

N00557600148

All of the function settings can be returned to their factory settings.

1. Press and hold the multi-information meter switch (for about 2 seconds or more) to change from the setting mode screen to the menu screen.

Refer to “Changing the function settings (With ignition switch in the “ON” position)” on page 5-123.

Multi-information display

2. Lightly press the multi-information meter switch to select “RESET” (return to the factory settings).

5

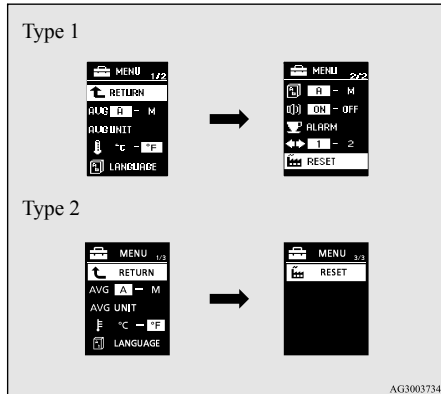

NOTE

- Cooperative language setting: A
- Operation sounds: ON (Operation sound on)
- “REST REMINDER” display: OFF
- Turn signal sound: Turn signal sound 1
- Momentary fuel consumption with the green bar graph (Type 2): ON

3. Press and hold the multi-information meter switch (for about 5 seconds or more), the buzzer sounds and all of the function settings are returned to the factory settings.

NOTE

- The factory settings are as follows.
 - Average fuel consumption and average speed reset mode: A (Auto reset)
 - Fuel consumption display unit: mpg (US) or (L/100 km)
 - Temperature unit: °F (Fahrenheit) or {°C (Centigrade)}
 - Display language: ENGLISH

Indicator light, warning light, and information screen display list

Indicator light, warning light, and information screen display list

N00557700035

Indicator and warning light list

N00557800238

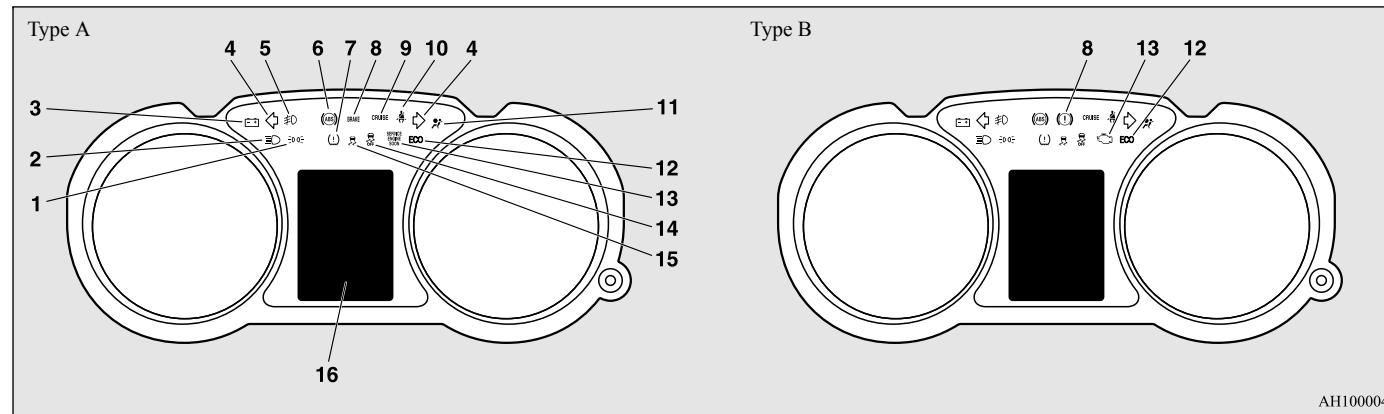

AH1000048

- 1- Position indicator →P.5-143
- 2- High beam indicator →P.5-143
- 3- Charging system warning light →P.5-145
- 4- Turn signal indicator/hazard warning light →P.5-143
- 5- Front fog light indicator (if so equipped) →P.5-143
- 6- Anti-lock braking system warning light →P.5-92

- 7- Tire pressure monitoring system warning light →P.5-103
- 8- Brake warning light →P.5-144
- 9- Cruise control indicator (if so equipped) →P.5-98
- 10- Seat belt reminder/warning light →P.4-11
- 11- Supplemental Restraint System (SRS) warning light →P.4-27

- 12- ECO mode indicator (if so equipped) →P.5-121
- 13- Engine malfunction indicator (“SERVICE ENGINE SOON” or “Check engine light”) →P.5-144
- 14- Active stability control (ASC) OFF indicator (if so equipped) →P.5-95
- 15- Active stability control (ASC) indicator (if so equipped) →P.5-95
- 16- Information screen display list →P.5-132

Features and controls 5-131

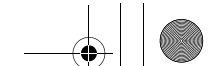

Indicator light, warning light, and information screen display list

Information screen display list

N00557900024

When there is information to be announced, such as light reminders, the tone sounds and the screen switches to the displays shown below. Refer to the appropriate page and take the necessary measures.

When the cause of the warning display is eliminated, the warning display goes out automatically.

Refer to “Warning display list (With ignition switch in the “OFF” position)” on page 5-132.

Refer to “Warning display list (With ignition switch in the “ON” position)” on page 5-135.

5

Refer to “Other interrupt displays (With ignition switch in the “ON” position)” on page 5-141.

NOTE

- In the following cases, a warning may be displayed on the information screen and the buzzer may sound for a few seconds, at times.

This is caused by the system picking up interference such as strong electromagnetic waves or noise, and is not a functional problem.

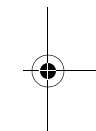
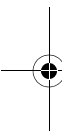

- An extremely strong electromagnetic wave is received from a source such as an illegal radio set, a spark from a wire, or a radar station.
- Abnormal voltage or a static electricity discharge is generated by the operation of installed electronics (including after-market parts).

If the warning display has occurred a number of times, take your vehicle to an authorized Mitsubishi Motors dealer or a repair facility of your choice and have the system checked.







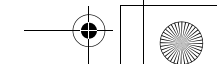
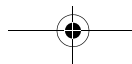

Warning display list (With ignition switch in the “OFF” position)

N00558000165

Screen type 1	Screen type 2	Cause	Do this (Reference)
		<ul style="list-style-type: none"> • You have forgotten to remove the key from the ignition switch. 	<ul style="list-style-type: none"> • Remove the key. Refer to “Key reminder system” on page 5-36.













Indicator light, warning light, and information screen display list

Screen type 1	Screen type 2	Cause	Do this (Reference)
 TURN OFF LIGHTS	 TURN OFF LIGHTS	<ul style="list-style-type: none"> You have forgotten to turn off the lights. 	<ul style="list-style-type: none"> Refer to “Light auto-cutout function (headlights and other lights)” on page 5-149.
	 ALARM ACTIVATING	<ul style="list-style-type: none"> The theft-alarm system is operating. 	<ul style="list-style-type: none"> Refer to “Theft-alarm system” on page 5-42.
 LOCK	 LOCK	<ul style="list-style-type: none"> After turning off the engine, an attempt was made to open the driver’s door with the ignition switch in any position other than “LOCK” (PUSH OFF). 	<ul style="list-style-type: none"> Turn the ignition switch to the “LOCK” (PUSH OFF) position. Refer to “Ignition switch return reminder system” on page 5-37.
		<ul style="list-style-type: none"> An attempt was made to lock all the doors and the trunk lid with the ignition switch in any position other than “LOCK” (PUSH OFF). 	<ul style="list-style-type: none"> Turn the ignition switch to the “LOCK” (PUSH OFF) position. Refer to “Ignition switch turn-off reminder system” on page 5-20.

5

Indicator light, warning light, and information screen display list

5

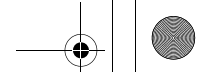

Screen type 1	Screen type 2	Cause	Do this (Reference)
 KEY BATTERY LOW	 KEY BATTERY LOW	<ul style="list-style-type: none"> There is a fault in the F.A.S.T.-key. 	<ul style="list-style-type: none"> Refer to “F.A.S.T.-key” on page 5-12.
 KEY MISSING	 KEY NOT DETECTED		
 CONFIRM KEY LOCATION	 KEY STILL IN VEHICLE		
 CHECK DOORS	 CHECK DOORS		
 SERVICE REQUIRED	 KEYLESS OPERATION SYSTEM SERVICE REQUIRED		



Indicator light, warning light, and information screen display list

Warning display list (With ignition switch in the “ON” position)

N00558101323





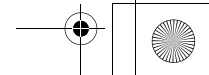
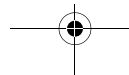





Screen type1	Screen type 2	Cause	Do this (Reference)
		<ul style="list-style-type: none"> There is a fault in the electric power steering system (EPS). 	<ul style="list-style-type: none"> Have the vehicle inspected by an authorized Mitsubishi Motors dealer or a repair facility of your choice as soon as possible. Refer to “Electric power steering system (EPS)” on page 5-97.

5













Indicator light, warning light, and information screen display list

5

Screen type1	Screen type 2	Cause	Do this (Reference)
 KEY BATTERY LOW	 KEY BATTERY LOW	<ul style="list-style-type: none"> ● There is a fault in the F.A.S.T.-key. 	<ul style="list-style-type: none"> ● Refer to “F.A.S.T.-key” on page 5-12.
 KEY MISSING	 KEY NOT DETECTED		
 CONFIRM KEY LOCATION	 KEY STILL IN VEHICLE		
 CHECK DOORS	 CHECK DOORS		
 SERVICE REQUIRED	 KEYLESS OPERATION SYSTEM SERVICE REQUIRED		
		<ul style="list-style-type: none"> ● Immobilizer is registered. 	<ul style="list-style-type: none"> ● Refer to “Electronic immobilizer (Anti-theft starting system)” on page 5-4, 5-28.











Indicator light, warning light, and information screen display list

Screen type1	Screen type 2	Cause	Do this (Reference)
		<ul style="list-style-type: none"> ● The brake fluid level is low. ● There is a fault in the brake system. 	<ul style="list-style-type: none"> ● Park the vehicle in a safe place and contact an authorized Mitsubishi Motors dealer or a repair facility of your choice for assistance. Refer to “Brake warning display” on page 5-145.
		<ul style="list-style-type: none"> ● There is a fault in the Anti-lock braking system. 	<ul style="list-style-type: none"> ● Avoid sudden braking and high-speed driving, park the vehicle in a safe place, and take corrective measures. Refer to “Anti-lock braking system warning light/display” on page 5-92.
		<ul style="list-style-type: none"> ● The tire pressure in one of the tires (except spare tire) is low. 	<ul style="list-style-type: none"> ● Refer to “Tire Pressure Monitoring System” on page 5-102.
		<ul style="list-style-type: none"> ● There is a fault in the Tire Pressure Monitoring System. 	<ul style="list-style-type: none"> ● Refer to “Tire Pressure Monitoring System” on page 5-102.
		<ul style="list-style-type: none"> ● One of the doors or the trunk lid is not completely closed. The open door or open trunk lid is displayed. 	<ul style="list-style-type: none"> ● Close the door or trunk lid. Refer to “Door ajar warning display (With ignition switch in the “OFF” position)” on page 5-114.









5

Indicator light, warning light, and information screen display list

5

Screen type1	Screen type 2	Cause	Do this (Reference)
 CLOSE HOOD	 CLOSE HOOD	<ul style="list-style-type: none"> The engine hood is open. 	<ul style="list-style-type: none"> Close the engine hood. Refer to “Engine hood” on page 9-3.
 CHECK	 ENGINE OVERHEATING STOP SAFELY	<ul style="list-style-type: none"> The engine is overheated. 	<ul style="list-style-type: none"> Park the vehicle in a safe place and take corrective measures. Refer to “Engine overheating” on page 8-4.
 SLOW DOWN	 TRANSMISSION OVERHEATING SLOW DOWN	<ul style="list-style-type: none"> The continuously variable transmission (CVT) fluid or the Twin Clutch SST fluid temperature is increased. 	<ul style="list-style-type: none"> Park the vehicle in a safe place and take corrective measures. Refer to “Continuously variable transmission (CVT)” on page 5-61. Refer to “Twin Clutch SST” on page 5-70.
 FASTEN SEAT BELT	 FASTEN SEAT BELT	<ul style="list-style-type: none"> The seat belt is not fastened when the ignition switch is in the “ON” position. 	<ul style="list-style-type: none"> Fasten your seat belt properly. Refer to “Driver’s seat belt reminder/warning light and display” on page 4-11.
 SERVICE REQUIRED	 FUEL SYSTEM SERVICE REQUIRED	<ul style="list-style-type: none"> There is a fault in the fuel system. 	<ul style="list-style-type: none"> Contact an authorized Mitsubishi Motors dealer or a repair facility of your choice to have the system checked.









Indicator light, warning light, and information screen display list

Screen type1	Screen type 2	Cause	Do this (Reference)
 RELEASE PARKING BRAKE	 RELEASE PARKING BRAKE	<ul style="list-style-type: none"> ● The vehicle is being driven with the parking brake still applied. 	<ul style="list-style-type: none"> ● Release the parking brake. Refer to “Brake warning display” on page 5-145.
 CHECK	 LOW OIL PRESSURE	<ul style="list-style-type: none"> ● There is a fault in the engine oil circulation system. 	<ul style="list-style-type: none"> ● Park your vehicle in a safe place as soon as possible and contact an authorized Mitsubishi Motors dealer or a repair facility of your choice to have the system checked. Refer to “Oil pressure warning display” on page 5-146.
 SERVICE REQUIRED	 CHARGING SYSTEM SERVICE REQUIRED	<ul style="list-style-type: none"> ● There is a fault in the charging system. 	<ul style="list-style-type: none"> ● Park your vehicle in a safe place as soon as possible and contact an authorized Mitsubishi Motors dealer or a repair facility of your choice for assistance. Refer to “Charging system warning display” on page 5-146.
 SERVICE REQUIRED	 AIRBAG SYSTEM SERVICE REQUIRED	<ul style="list-style-type: none"> ● There is a fault in the SRS airbag or the seat belt pre-tensioner system. 	<ul style="list-style-type: none"> ● Contact an authorized Mitsubishi Motors dealer or a repair facility of your choice to have the system checked, immediately. Refer to “SRS warning light/display” on page 4-27.







5

Indicator light, warning light, and information screen display list

5

Screen type1	Screen type 2	Cause	Do this (Reference)
		<ul style="list-style-type: none"> There is a fault in the Active Stability Control (ASC). 	<ul style="list-style-type: none"> Contact an authorized Mitsubishi Motors dealer or a repair facility of your choice to have the system checked. Refer to “Active Stability Control (ASC)” on page 5-94.
		<ul style="list-style-type: none"> There is a fault in the ACD (Active Center Differential system). There is a fault in the electronically controlled 4WD system. 	<ul style="list-style-type: none"> Contact an authorized Mitsubishi Motors dealer or a repair facility of your choice to have the system checked. Refer to “ACD (Active Center Differential system)” on page 5-82. Contact an authorized Mitsubishi Motors dealer or a repair facility of your choice to have the system checked. Refer to “Electronically controlled 4WD system” on page 5-84.
		<ul style="list-style-type: none"> There is a fault in the CVT. A safety device in the Twin Clutch SST has been activated due to a possible malfunction in the Twin Clutch SST or in the engine electronic control module. 	<ul style="list-style-type: none"> Contact an authorized Mitsubishi Motors dealer or a repair facility of your choice to have the system checked. Refer to “Continuously variable transmission (CVT)” on page 5-61. Refer to “Twin Clutch SST” on page 5-70.
		<ul style="list-style-type: none"> The electronically controlled 4WD system is hot. 	<ul style="list-style-type: none"> Refer to “Electronically controlled 4WD system” on page 5-84.

Indicator light, warning light, and information screen display list

Screen type1	Screen type 2	Cause	Do this (Reference)
 REFUEL	 REFUEL	<ul style="list-style-type: none"> The fuel is running low. 	<ul style="list-style-type: none"> Refuel as soon as possible. Refer to “Fuel remaining display screen” on page 5-121.
 POSSIBLE ICY ROADS	 POSSIBLE ICY ROADS	<ul style="list-style-type: none"> The outside temperature is 37 °F (3 °C) or less. 	<ul style="list-style-type: none"> Be careful driving on frozen ground. The ground may be frozen even when this warning is not displayed, so drive carefully.
 CHECK	 ENGINE SYSTEM SERVICE REQUIRED	<ul style="list-style-type: none"> The timing chain may be worn. 	<ul style="list-style-type: none"> Contact an authorized Mitsubishi Motors dealer or a repair facility of your choice to have the system checked.

5







Other interrupt displays (With ignition switch in the “ON” position)

N00558200239



The operation status of each system is displayed on the information screen. For further details, refer to the appropriate page for each system.

Indicator light, warning light, and information screen display list

5



Screen type 1	Screen type 2	System operation status	Reference
		<ul style="list-style-type: none"> When "2WD" drive mode is selected with the drive mode selector. 	<ul style="list-style-type: none"> Refer to "Electronically controlled 4WD system" on page 5-84.
		<ul style="list-style-type: none"> When "4WD AUTO" mode is selected with the drive mode selector. 	
		<ul style="list-style-type: none"> When "4WD LOCK" mode is selected with the drive mode selector. 	
		<ul style="list-style-type: none"> When the Active Stability Control (ASC) is operating. 	<ul style="list-style-type: none"> Refer to "Active Stability Control (ASC)" on page 5-94.

This informs you that a periodic inspection is due.

Screen type 1	Screen type 2	Do this
		Have an inspection made by an authorized Mitsubishi Motors dealer. For further details, refer to "Service reminder" on page 5-121.

Indicators

The rest time can be set.

Screen type 1	Screen type 2	Do this
		<p>Park the vehicle in a safe place, turn off the engine, and take a rest. Use this display as rough guide for taking rests during a long drive. The interval from the start of your trip until this message is displayed can be set. Refer to “Changing the function settings (With ignition switch in the “ON” position)” on page 5-123.</p> <p>The display and buzzer alert the driver when the set time is reached. If you continue to drive without having a rest, the buzzer sounds about every 5 minutes to encourage you to take a rest.</p> <ul style="list-style-type: none"> • In the following cases, the time driven is reset and the display returns to the previous display screen. After this, when the set time is reached again, the display and buzzer encourage you to take a rest. <ul style="list-style-type: none"> • The buzzer sounds 3 times. • The ignition switch is turned to the “OFF” position. • The multi-information meter switch is held (for about 2 seconds or more).

5

Indicators

N00519900127

Turn signal indicators/Hazard warning lights

N00520000216

The arrows will flash in time with the corresponding exterior turn signals when the turn signal lever is used.

Both arrows will flash when the hazard warning flasher switch is pressed.

NOTE

- If the indicator flashes faster than usual or if the indicator stays on without flashing, check for a malfunctioning turn signal light bulb or turn signal connection.

High beam indicator

N00520100086

A blue light comes on when the headlights are on high beam.

Front fog light indicator (if so equipped)

N00520200205

This indicator comes on while the front fog lights are on.

Position indicator

N00551300026

This indicator light illuminates while the position lights are on.



Warning lights

Warning lights

N00520300147

Brake warning light

N00520400467

5

When the ignition switch is turned to the “ON” position, this indicator normally comes on and goes out a few seconds later. A warning is also displayed in the multi-information display.

The warning light also illuminates after starting the engine under the following conditions:

- When the parking brake is still applied.
- When the brake fluid level is low.
- When the brake force distribution function is not operating correctly.

Before driving, be sure that the parking brake is fully released and brake warning light is off.

CAUTION

- If the brake warning light and the anti-lock braking system warning light are illuminated at the same time, the braking force distribution function will not operate, so the vehicle may be destabilized during sudden braking under the following conditions.

CAUTION

- When the brake warning light does not go out even when the parking brake is released.
- When the brake warning light stays on while driving.
- If the above occurs, avoid sudden braking and high-speed driving. Park the vehicle in a safe place, and contact an authorized Mitsubishi Motors dealer or a repair facility of your choice as soon as possible.
- The vehicle should be brought to a halt in the following manner when brake performance is deteriorated.
 - Confirm that the vehicle slows down when you press down on the brake pedal harder than usual. In some cases, the brake pedal may go all the way to the floor.
 - Should the brakes fail, use engine braking to reduce your speed and slowly apply the parking brake. Depress the brake pedal to illuminate the stop lights to alert the vehicles behind you.
- Do not suddenly apply the parking brake while driving. This may cause the rear wheels to lock and cause an accident.

Engine malfunction indicator (“SERVICE ENGINE SOON” or “Check engine light”)

N00520500774

This indicator is a part of the onboard diagnostic (OBD) system which monitors the emissions, engine control system or continuously variable transmission (CVT) control system / Twin Clutch SST control system. If a problem is detected in one of these systems, this indicator illuminates or flashes. When the ignition switch is turned to the “ON” position, this indicator normally comes on and goes off after the engine has started.

This indicator will come on if the fuel tank filler cap is not properly tightened. If this indicator comes on and stays on after refueling, stop the engine and check that the cap is properly tightened. (Turn the cap clockwise until you hear clicking sounds.)

If this indicator does not go off after several seconds or lights up while driving, have the system checked as soon as possible at an authorized Mitsubishi Motors dealer or a repair facility of your choice.

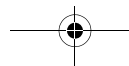
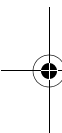

Information screen display

CAUTION

- Driving for a long time with the engine malfunction indicator on may cause more damage to the emission control system. This could also affect fuel economy and drivability.
- If this indicator does not come on when the ignition key is turned to the “ON” position, have the system checked at an authorized Mitsubishi Motors dealer or a repair facility of your choice.
- If the engine malfunction indicator comes on while the engine is running, avoid driving at high speeds.

During vehicle operation with the indicator on, the vehicle may not accelerate when you depress the accelerator pedal.

When the vehicle is stationary with the indicator on, you must depress the brake pedal more firmly than usual since the engine idling speed is higher than usual and a vehicle with a CVT or a Twin Clutch SST has a stronger tendency to creep forward.

NOTE

- Do not disconnect the battery cable when the engine malfunction indicator (“SERVICE ENGINE SOON” or “Check engine light”) is on.
The engine electronic control module stores critical OBD information (especially exhaust emission data), which may be lost if the battery cable is disconnected while the engine malfunction indicator is on. This will make it difficult to diagnose the cause of future problems.

Charging system warning light

N00520600296

This light comes on in the event of a malfunction in the charging system or when the ignition switch is turned to the “ON” position (engine off). A warning is also displayed in the multi-information display. When the engine is started, the light should go out. Check to make sure that the light has gone out before driving.

CAUTION

- If the warning light stays on while the engine is running, park your vehicle in a safe place as soon as possible and contact an authorized Mitsubishi Motors dealer or a repair facility of your choice to have the system checked.

Information screen display

N00558300025

Brake warning display

N00558400084

Type 1



5

Type 2



This warning is displayed if the vehicle is being driven with the parking brake still applied. The warning light in the instrument cluster only comes on when the parking brake is applied.

CAUTION

- If a vehicle is driven without releasing the parking brake, the brakes will overheat, resulting in ineffective braking and possible brake failure.
If this warning is displayed while driving, release the parking brake.

Information screen display

Type 1



Type 2



When the ignition switch is turned to the "ON" position, if the brake fluid is low, this warning is displayed.

The warning light in the instrument cluster also illuminates.

CAUTION

- If this warning stays on and does not go out while driving, there is a danger of ineffective braking. If this happens, park the vehicle in a safe place, and contact an authorized Mitsubishi Motors dealer or a repair facility of your choice.

CAUTION

- If the brake warning display, brake warning light, and the Anti-lock braking system warning light are illuminated at the same time, the braking force distribution function will not operate, so the vehicle may be destabilized during sudden braking. Avoid sudden braking and high-speed driving. Park the vehicle in a safe place, and contact an authorized Mitsubishi Motors dealer or a repair facility of your choice.
- The vehicle should be brought to a halt in the following manner when brake performance is deteriorated.
 - Confirm that the vehicle slows down when you press down on the brake pedal harder than usual. In some cases, the brake pedal may go all the way to the floor.
 - Should the brakes fail, use engine braking to reduce your speed and slowly apply the parking brake. Depress the brake pedal to illuminate the stop lights to alert the vehicles behind you.

Charging system warning display

N00558600057

Type 1



Type 2



If there is a fault in the charging system, the warning display is displayed on the information screen in the multi-information display. The warning light in the instrument cluster also illuminates.

CAUTION

- If warnings are displayed while the engine is running, park your vehicle in a safe place as soon as possible and contact an authorized Mitsubishi Motors dealer or a repair facility of your choice to have the system checked.

Oil pressure warning display

N00558700045

Type 1



Type 2



If the engine oil pressure drops while the engine is running, the warning display is displayed on the information screen in the multi-information display.

CAUTION

- If the vehicle is driven while the engine oil is low, or the oil level is normal but the warning is displayed, the engine may overheat and damage may result.
- If the warning is displayed while the engine is running, park your vehicle in a safe place as soon as possible and check the engine oil level.
- If this warning display comes on when the engine oil level is proper, have your vehicle checked at an authorized Mitsubishi Motors dealer or a repair facility of your choice.

NOTE

- The oil pressure warning display does not show the amount of oil. The oil level must be checked using the dipstick.

Combination headlights and dimmer switch

N00522501762

Headlights

NOTE

- Do not leave the headlights and other lights on for a long period of time when the engine is not running. The battery will run down.
- When it rains, or when the vehicle has been washed, the inside of the lens sometimes becomes foggy. This is the same as when window glass mists up on a humid day, and does not indicate a problem. When the light is switched on, the heat will dry out the fog. However, if water collects inside the light, have it checked by an authorized Mitsubishi Motors dealer or a repair facility of your choice.

Type 1

Rotate the switch to operate the lights.

Combination headlights and dimmer switch

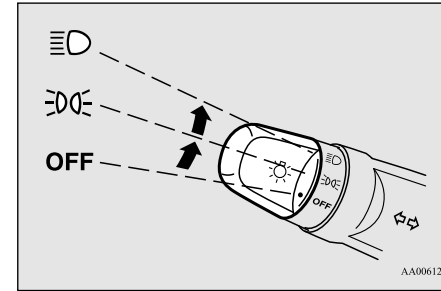

AA0061221

5

OFF	All lights off
	Parking, tail, front and rear side-marker lights, license plate and instrument panel lights on
	Headlights and other lights on

If your vehicle is equipped with daytime running lights, the combinations of switch operations and illuminated lights differ in accordance with the following conditions.



[When the engine is started, and the parking brake is released]

The daytime running lights will be illuminated:

OFF	The daytime running lights illuminated
-----	--

Combination headlights and dimmer switch

5



	The daytime running lights illuminated Parking, tail, front and rear side-marker lights, license plate and instrument panel lights on
	Headlights and other lights on

NOTE

- Once the daytime running light come on, they do not go out until the key is turned to the "LOCK" or "ACC" position.

[When the engine is not running, or when the engine is running but the parking brake is not released]

The engine starts when the lights are off.



OFF	All lights off
	Parking, tail, front and rear side-marker lights, license plate and instrument panel lights on
	Headlights and other lights on

Type 2

Rotate the switch to operate the lights.

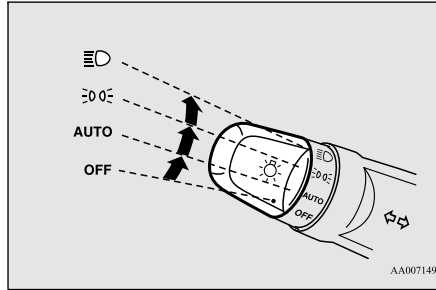
5-148 Features and controls





OFF	All lights off
AUTO	Headlights and other lights turn on and off automatically in accordance with outside light level.
	Parking, tail, front and rear side-marker lights, license plate and instrument panel lights on
	Headlights and other lights on

If your vehicle is equipped with daytime running lights, the combinations of switch operations and illuminated lights differ in accordance with the following conditions.

[When the engine is started, and the parking brake is released]

The daytime running lights will be illuminated:

OFF	The daytime running lights illuminated
AUTO	The daytime running lights illuminated Headlights and other lights turn on and off automatically in accordance with outside light level.
	The daytime running lights illuminated Parking, tail, front and rear side-marker lights, license plate and instrument panel lights on
	Headlights and other lights on

NOTE

- Once the daytime running light come on, they do not go out until the key is turned to the "LOCK" or "ACC" position.

[When the engine is not running, or when the engine is running but the parking brake is not released]

The engine starts when the lights are off.

OFF	All lights off
AUTO	Headlights and other lights turn on and off automatically in accordance with outside light level.

☰	Parking, tail, front and rear side-marker lights, license plate and instrument panel lights on
☷	Headlights and other lights on

NOTE

- The sensitivity of the automatic on/off control can be adjusted. For further information, please contact your authorized Mitsubishi Motors dealer or a repair facility of your choice.
- Do not cover the sensor (A) for the automatic on/off control by affixing a sticker or label to the windshield.

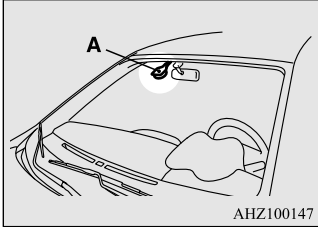

AHZ100147

- If the lights do not turn on or off with the switch in the "AUTO" position, manually operate the switch and we recommend you to have your vehicle checked.

Light auto-cutout function (headlights and other lights)

N00532601607

- If the ignition key is turned to "LOCK" or "ACC" position or removed from the ignition switch and the driver's door is opened with the combination headlights and dimmer switch in the "☰" or "☷" position, the lights automatically turn off.

[When using a key to start the engine]

- If the driver's door is opened after the key is removed from the ignition switch, a high-pitched constant tone will sound to remind you to turn off the lights.
- If the driver's door is opened with the key in the ignition switch, a low-pitched tone will sound to remind you to remove the key.

[When using the F.A.S.T.-key to start the engine]

- If the ignition switch is turned to the "LOCK" position and the driver's door is opened, a high-pitched constant buzzer will sound to remind you to turn off the lights.
- If the ignition switch is turned to any position other than "LOCK" and the driver's door is opened, a low-pitched constant buzzer will sound to remind you to return the ignition switch.

Combination headlights and dimmer switch

- If the ignition switch is turned to "LOCK" or "ACC" position with the driver's door closed and the combination headlights and dimmer switch in the "☰" or "☷" position, the lights will stay on for about 3 minutes and then turn off automatically.

NOTE

- The light auto-cutout function can be deactivated. See your authorized Mitsubishi Motors dealer for details.

5

When you want to keep the lights on:

If the combination headlights and dimmer switch is turned to the "☰" or "☷" position again after the engine is turned off, the about 3 minutes auto-cutout function described above will not work. The lights (the parking lights, tail lights and license plate lights) will stay on and will not turn off automatically.

Combination headlights and dimmer switch

NOTE

- When the engine is started using the key, if the driver's door is opened and the key is removed, the headlight reminder buzzer intermittently emits a high-pitched sound. If the key is still in the ignition the key reminder buzzer intermittently emits a low-pitched sound.

The buzzer stops when the driver's door is closed. (A warning is also displayed in the multi-information display.)

- When the engine is started using the keyless operation function, if the driver's door is opened and the ignition switch is in the "LOCK" position, the headlight reminder buzzer intermittently emits a high-pitched sound. If the ignition switch is in any position other than "LOCK", the ignition switch on reminder buzzer intermittently emits a low-pitched sound.

The buzzer stops when the driver's door is closed. (A warning is also displayed in the multi-information display.)

Headlight reminder buzzer

N00549800196

When using a key to start the engine

If the driver's door is opened with the key in the "LOCK" or "ACC" position or removed

5-150 Features and controls

from the ignition switch while the lights are on, the buzzer will sound to remind you to turn off the lights.

When using the F.A.S.T.-key to start the engine

If the driver's door is opened with the ignition switch in the "LOCK" or "ACC" position, or if the ignition switch is moved to the "LOCK" position while the lights are on, the buzzer will sound to remind you to turn off the lights.

In either case, the lights and buzzer will turn off automatically.

Or you can turn the combination headlights and dimmer switch to the "OFF" position to stop the buzzer.

Dimmer (high/low beam change)

N00549900155

To change the headlights from high beam to low beam and vice versa, pull the turn signal lever to fully toward you (1). Switch the headlights to low beam as a courtesy whenever there are oncoming vehicles, or when there is traffic moving ahead of you. An illuminated blue light in the instrument cluster

indicates when the headlights are on high beam.

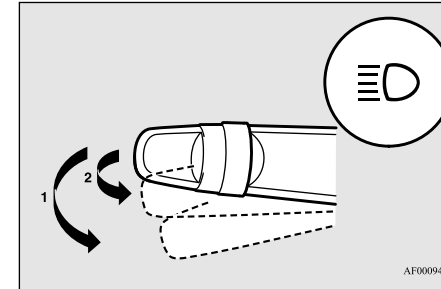

Headlight flasher

N00550000198

You can flash the high beams by pulling the lever gently toward you (2). The lights will go back to normal when you let go. While the high beam is on, you will see a blue light on the instrument panel.

NOTE

- You can flash the high beams by pulling the lever toward you, even if the combination headlights and dimmer switch is off.

Combination headlights and dimmer switch

NOTE

- If you turn the lights off with the headlights set to high-beam illumination, the headlights are automatically returned to their low-beam setting when the combination headlights and dimmer switch is next turned to the “D” position.

Welcome light (for vehicles with the theft-alarm system)

N00563201133

This function turns on the front side-marker and parking lights for about 30 seconds after the UNLOCK button (A) on the remote control transmitter is pressed when the combination headlights and dimmer switch is in the “OFF” or “AUTO” position (for vehicles equipped with the automatic light control). On vehicles equipped with the automatic light control, the welcome light function will operate only when it is dark outside the vehicle.

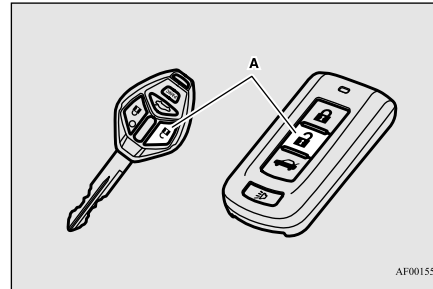



AF0015519

NOTE

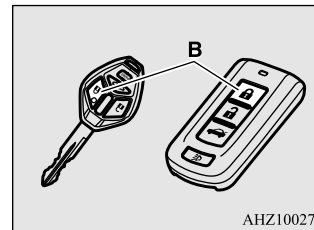
- While the welcome light function is operating, perform one of the following operations to cancel the function.
 - Push the LOCK button (B) on the remote control transmitter.



AHZ100277

- Turn the combination headlights and dimmer switch to the “D” or “D” position.
- Turn the ignition switch to the “ON” position.
- It is possible to modify functions as follows:
 - The headlights can be set to come on in the low beam setting.

NOTE

- The welcome light function can be deactivated. For details, consult a Mitsubishi Motors dealer.

Coming home light

N00547300054

5

This function turns on the headlights in the low beam setting for about 30 seconds after the ignition switch is turned to the “LOCK” position.

1. Turn the combination headlights and dimmer switch to the “OFF” or “AUTO” position (for vehicles equipped with the automatic light control).
2. Turn the ignition switch to the “LOCK” position. Also, if a key was used to start the engine, remove the key from the ignition switch.
3. Within 60 seconds of turning the ignition switch to the “LOCK” position, pull the turn signal lever toward you.

Headlight leveling switch (if so equipped)

5

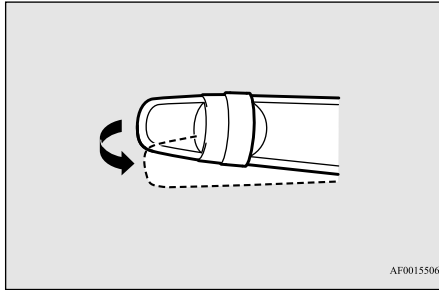

AF0015506

4. The headlights will come on in the low beam setting for about 30 seconds. After the headlights go off, the headlights can be turned on again in the low beam setting for about 30 seconds by pulling the turn signal lever toward you within 60 seconds of turning the ignition switch to the “LOCK” position. To turn on the headlights again after 60 seconds of turning the ignition switch to the “LOCK” position, repeat the process from step 1.

NOTE

- While the coming home light function is operating, perform one of the following operations to cancel the function.
 - Pull the turn signal lever toward you.
 - Turn the combination headlights and dimmer switch to the “ ” or “ ” position.
 - Turn the ignition switch to the “ON” position.

5-152 Features and controls

NOTE

- It is possible to modify functions as follows:
 - The time that the headlights remain on can be changed.
 - The coming home light function can be deactivated.
- For details, consult a Mitsubishi Motors dealer.

Headlight leveling switch (if so equipped)

N00537100088

The direction of the headlight beam (the direction in which the light shines) alters according to the number of people and the load in the vehicle. Lower the headlight angle if it is too high due to the number of people and/or the load in the vehicle so that the headlights’ glare does not distract the drivers of approaching vehicles. First set the combination headlights and dimmer switch to the “ ” position, then turn the headlight leveling switch knob to lower the beam. The greater the number on the headlight leveling switch knob, the lower the beam will point. Set the switch to the appropriate position so that the headlight beam is level with the road.

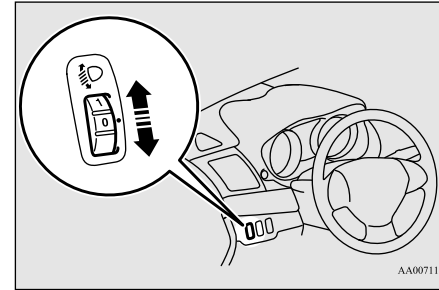

AA0071149

NOTE

- Start adjusting when the knob is at the “0” position (when the beam is at its highest).
- Keep the knob in the “0” position except when using the knob to lower the headlight beam angle.
- Always return the knob to the “0” position when the load is removed and the people have left the vehicle.

Turn signal lever

N00522601545

When changing lanes, or to making a gradual turn, hold the lever in the “lane change” position (1). It will return to the neutral position when you let go. Use the full position (2) when making a normal turn. The lever will return to the neutral position when the turn is complete. There may be times when the lever

does not return to the neutral position. This usually happens when the steering wheel is turned only slightly. You can easily return the lever by hand.

Also, when you move the lever to (1) slightly then release it, the turn signal lights and indicator light in the instrument cluster will flash three times.

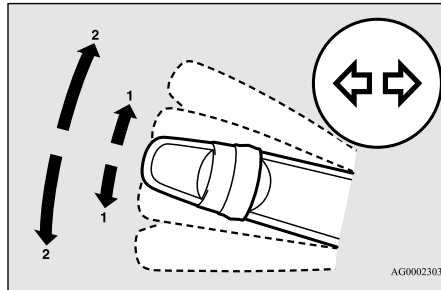

AG0002303

NOTE

- A light in the instrument panel flashes to show when the front and rear turn signal lights are working properly. If this light flashes faster than usual, check for a burned out light bulb or malfunctioning connection. If the panel light does not come on when the lever is moved, check for a blown fuse or a burned out bulb in the panel. Have the vehicle inspected by an authorized Mitsubishi Motors dealer or a repair facility of your choice.

NOTE

- The turn signal light 3-flash function for lane changes can be deactivated. See your authorized Mitsubishi Motors dealer for details.
- You can adjust the time required to operate the lever for the 3-flash function. See your authorized Mitsubishi Motors dealer for details.

Hazard warning flasher switch

N00522700217

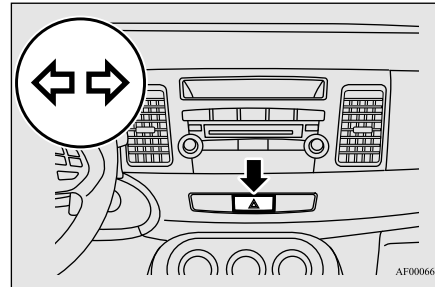

AF0006601

If you press the flasher switch, the front and rear turn signals will flash intermittently, and so will the hazard warning lights. This is an emergency warning system and should not be

Hazard warning flasher switch

used when the vehicle is in motion, except for emergencies.

If you need to leave your vehicle, the flashers will keep working after the ignition key is removed.

NOTE

- If you keep the flashers on for several hours with the engine turned off, the battery will run down.

5

Front fog light switch (if so equipped)

N00522800377

The front fog lights illuminate only when the headlights are on low beam.

Turning the knob in the direction of the “ON” position turns on the front fog lights as well as the indicator in the instrument cluster. To turn them off, turn the knob in the direction of the “OFF” position.

The knob will return to the neutral position when it is released.

Wiper and washer switch

5

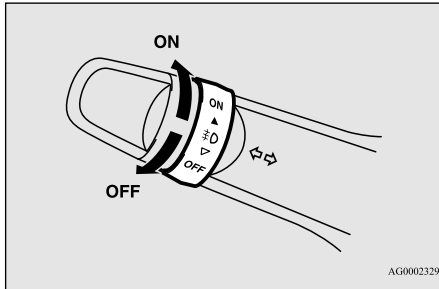

Wiper and washer switch

N00523000608

CAUTION

- If the washer is used in cold weather, the washer fluid sprayed against the glass may freeze, which may hinder visibility. Warm the glass with the defroster before using the washer.

NOTE

- If the headlights are switched to high beam, the front fog lights will go out; they will illuminate again when the headlights are switched back to low beam.
- If the combination headlights and dimmer switch is rotated to the “OFF” or “ ” position while the front fog lights are illuminated, they will automatically turn off. They can be turned back on again by rotating the combination headlights and dimmer switch back to “ ” position, and turning the knob in the direction of the “ON” position.

Windshield wipers

N00542900013

Except for vehicle with rain sensor

N00569100010

The windshield wiper and washer can be operated with the ignition switch in the “ON” or “ACC” position.

If the blades are frozen to the windshield, do not operate the wipers until the ice has melted and the blades are freed, otherwise the wiper motor may be damaged.

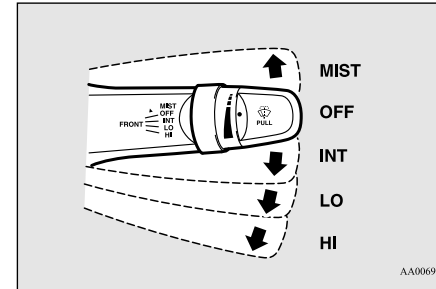

MIST- Misting function

The wipers will operate once.

OFF- Off

INT- Intermittent (Speed sensitive)

LO- Slow

HI- Fast

To adjust intermittent intervals

N00569201034

With the lever in the “INT” (speed sensitive intermittent operation) position, the intermittent intervals can be adjusted by turning the knob (A).

Wiper and washer switch

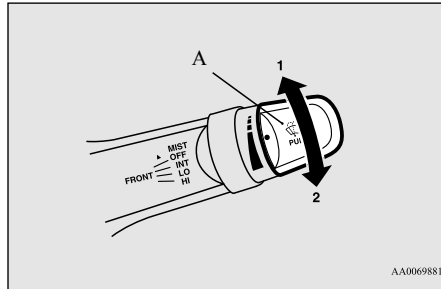

- 1- Fast
- 2- Slow

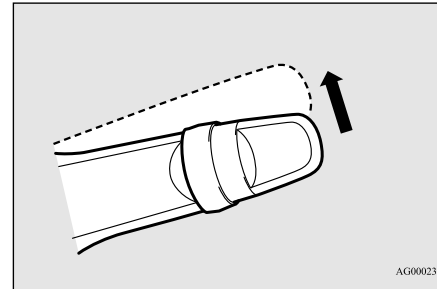

The wipers will operate once if the wiper lever is raised to the “MIST” position and released. This operation is useful when it is drizzling, etc. The wipers will continue to operate while the lever is held in the “MIST” position.

Vehicle with rain sensor

N00569400013

The windshield wipers can be operated with the ignition switch in the “ON” or “ACC” position.

If the blades are frozen to the windshield or rear window, do not operate the wipers until the ice has melted and the blades are freed, otherwise the wiper motor may be damaged.

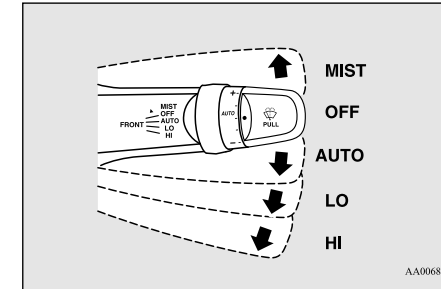

MIST- Misting function

The wipers will operate once.

OFF- Off

AUTO- Auto-wiper control

Rain sensor

The wipers will automatically operate depending on the amount of moisture on the windshield.

LO- Slow

HI- Fast

Rain sensor (if so equipped)

N00569500014

Can only be used when the ignition switch is “ON” position.

If the lever is put in the “AUTO” position, the rain sensor (B) will detect the extent of rain (or snow, other moisture, dust, etc.) and the wipers will operate automatically.

NOTE

- The speed-sensitive-operation function of the windshield wipers can be deactivated. For further information, please contact your authorized Mitsubishi Motors dealer or a repair facility of your choice.

Misting function

N00569300012

The misting function can be used when the ignition switch is in the “ON” or “ACC” position.

Wiper and washer switch

Keep the lever in the “OFF” position if the windshield is dirty and the weather is dry.

Wiper operation under these conditions can scratch the windshield and damage the wipers.

5

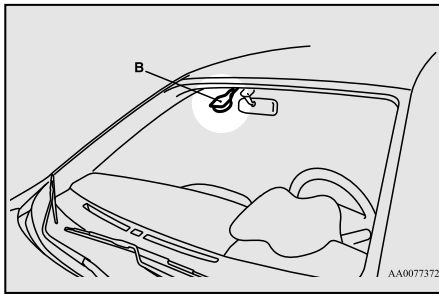

CAUTION

- With the ignition switch in the “ON” position and the lever in the “AUTO” position, the wipers may automatically operate in the situations described below.
 - When cleaning the outside surface of the windshield, if you touch the rain sensor.
 - When cleaning the outside surface of the windshield, if you wipe with a cloth the rain sensor.
 - When using an automatic car wash.
 - A physical shock is applied to the windshield.
 - A physical shock is applied to the rain sensor.

CAUTION

If your hands get trapped, you could suffer injuries or the wipers could malfunction. To deactivate the rain sensor, place the lever in the “OFF” position.

NOTE

- To protect the rubber parts of the wipers, this operation of the wipers does not take place when the vehicle is stationary and the ambient temperature is about 32 °F (0 °C) or lower.
- Do not cover the sensor by affixing a sticker or label to the windshield. Also, do not put any water-repellent coating on the windshield. The rain sensor would not be able to detect the extent of rain, and the wipers might stop working normally.
- In the following cases, the rain sensor may be malfunctioning. Have the vehicle checked at an authorized Mitsubishi Motors dealer or a repair facility of your choice.
 - When the wipers operate at a constant interval despite changes in the extent of rain.
 - When the wipers do not operate even though it is raining.

NOTE

- The wipers may automatically operate when things such as insects or foreign objects are affixed to the windshield on top of the rain sensor or when the windshield is frozen. Objects affixed to the windshield will stop the wipers when the wipers cannot remove them. To operate the wipers again, move the lever to the “LO” or “HI” position. Also, the wipers may operate automatically due to strong direct sunlight or electromagnetic wave. To stop the wipers, move the lever to the “OFF” position.
- Contact an authorized Mitsubishi Motors dealer or a repair facility of your choice when replacing the windshield glass.

To adjust the sensitivity of the rain sensor

N00569601038

With the lever in the “AUTO” (rain sensor) position, it is possible to adjust the sensitivity of the rain sensor by turning the knob (C).

Wiper and washer switch

(D) is turned in the “+” direction when the ignition switch is “ON” position.

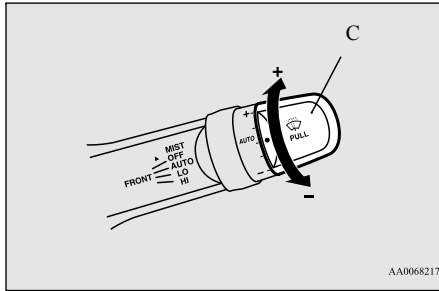

AA0068217

“+”- Higher sensitivity to rain
 “-”- Lower sensitivity to rain

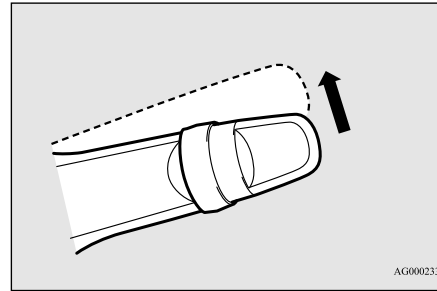

AG0002332

The wipers will operate once if the lever is raised to the “MIST” position and released when the ignition switch is in the “ON” or “ACC” position. The wipers will continue to operate while the lever is held in the “MIST” position.

Windshield washer

N00504601325

To turn on the windshield washer, pull the lever toward you with the ignition switch in either the “ON” or “ACC” position.

5

The washer fluid will be sprayed onto the windshield by pulling the lever toward you.

When the wipers are not in operation or in intermittent operation, by pulling the lever toward you, the wipers will operate several times while the washer fluid is being sprayed.

Also, by releasing the lever soon after pulling it toward you, the washer fluid will be sprayed several times while the wipers are operating several times. (Intelligent washer) Intelligent washer will stop operating with any operation of the lever.

NOTE

- It is possible to activate the following functions.
 - Automatic operation (rain droplet sensitive) can be changed to intermittent operation (vehicle speed-sensitive, or at adjustable intervals).
- For further information, please contact your authorized Mitsubishi Motors dealer or a repair facility of your choice.

Misting function

N00569700016

Move the lever in the direction of the arrow and release, to operate the wipers once. Use this function when you are driving in mist or drizzle.

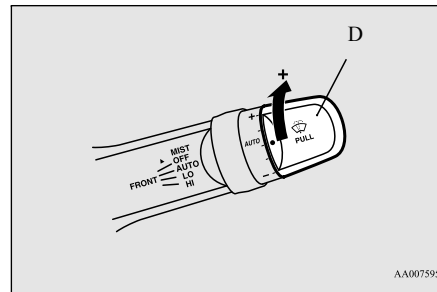

AA0075958

The wipers will operate once if the lever is moved to the “AUTO” position and the knob

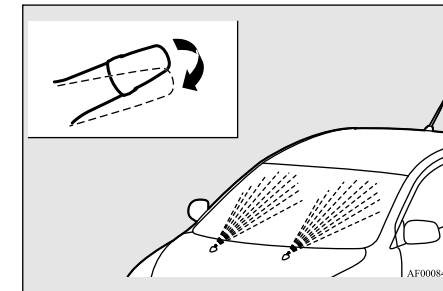

AF0008429

Electric rear window defogger switch

5

NOTE

- It is possible to modify functions as follows:
 - Causing the wiper never to operate when washer fluid is sprayed.
 - Intelligent washer can be deactivated.
 - The wipers can be set to operate again after about 6 seconds.
- For details, consult a Mitsubishi Motors dealer.

Precautions to observe when using wipers and washers

N00523500209

CAUTION

- If the washer is used in cold weather, the washer fluid sprayed onto the glass might freeze, blocking your view. In cold weather, heat the glass with the defroster before using the washer.

NOTE

- Do not use the wipers when the windshield is dry. This could scratch the glass and wear the wiper blades prematurely.
- Before using the wipers in cold weather, check to be sure that the wiper blades are not frozen to the windshield. Using the wipers while the blades are frozen could cause the wiper motor to burn out.

NOTE

- If the wipers become blocked by ice or other deposits on the glass, the motor may still burn out even if the wiper switch is OFF. If deposits form on the windshield, park your vehicle in a safe place, turn off the engine, and clean the glass so that the wipers can operate smoothly.
- Avoid using the washer for more than 20 seconds at a time. Do not operate the washer when the fluid reservoir is empty or the pump may fail.
- During cold weather, add a recommended washer solution that will not freeze in the washer reservoir. Otherwise the washer may not work or may be damaged.
- Replace the wiper blades when they are worn. Use the proper size replacement blades. If you have questions, ask your authorized Mitsubishi Motors dealer.

Electric rear window defogger switch

N00523700315

The electric rear window defogger can be used when the engine is running. The indicator light (A) will come on when you press the electric rear window defogger switch. Electric current will flow through the heating wires on the rear window to help clear away moisture or frost.

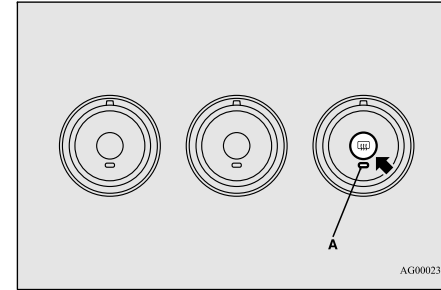

After about 20 minutes of operation, the system will shut off automatically.

To switch the defogger OFF before 20 minutes have passed, press the switch again. The indicator light will go out and the defogger will turn off.

If you need the defogger for more than 20 minutes, press the switch again. This will add 20 more minutes.

CAUTION

- The rear window defogger is not designed to melt snow. Remove any snow manually before using the rear window defogger.
- Use the rear window defogger only after the engine has started and is running. Be sure to turn the defogger switch off immediately after the window is clear to save on battery power.

Horn switch

CAUTION

- Do not place stickers, tape, or other items that are attached with adhesive over the grid wires on the rear window.
- When cleaning the inside rear window, use a soft cloth and wipe lightly over the grid wires.

NOTE

- If your vehicle is equipped with heated mirrors, mist can also be removed from the outside rearview mirrors when the rear window defogger switch is pressed. (Refer to “Heated mirror” on page 5-53.)

Horn switch

N00523800156

To honk the horn, press around the “” mark on the steering wheel.

Type 1

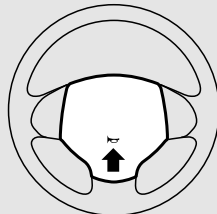

AG0002361

Type 2

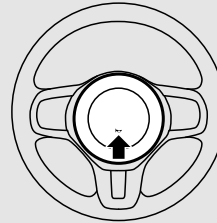

AA0073895

Link System (if so equipped)

N00563701095

The Link System control of the devices connected via the USB input terminal or the Bluetooth[®] 2.0 interface; the system allows the connected device to be operated by using the switches in the vehicle or voice commands.

See the following section for details on how to operate.

Refer to “Bluetooth[®] 2.0 interface” on page 5-159.

Refer to “USB input terminal” on page 5-181.

Refer to “Listen to Audio Files on a USB Device” on page 7-49.

Refer to “Listen to Bluetooth Audio” on page 7-52.

Bluetooth[®] is a registered trademark of BLUETOOTH SIG, INC.

Link System End User License Agreement

N00563801038

You have acquired a device that includes software licensed to Mitsubishi Motors Corporation from JOHNSON CONTROLS Inc (the automotive experience business unit), and their subsequent 3rd party suppliers. For a complete list of these 3rd party products and their end user license agreements, please go to the following website.

<http://www.jciblueconnect.com/faq/fulldisclosure.pdf>

Bluetooth[®] 2.0 interface (if so equipped)

N00563901228

The Bluetooth[®] 2.0 interface allows for making/receiving hands-free calls in the vehicle using a Bluetooth[®] compatible cellular phone based on the wireless communication technology commonly known as Bluetooth[®]. It also allows the user to play music, saved in a Bluetooth[®] music player, from the vehicle’s speakers.

Features and controls 5-159

Bluetooth® 2.0 interface (if so equipped)

The system is equipped with a voice recognition function, which allows you to make hands-free calls by simple switch operations and voice command operations using a defined voice tree.

5

The Bluetooth® 2.0 interface can be used when the ignition switch is in the “ON” or “ACC” position.

Before you can use the Bluetooth® 2.0 interface, you must pair the Bluetooth® device and Bluetooth® 2.0 interface. Refer to “Connecting the Bluetooth® 2.0 interface and Bluetooth® device” on page 5-166.

Bluetooth® is a registered trademark of BLUETOOTH SIG, INC.

WARNING

- Although the Bluetooth® 2.0 interface allows you to make hands-free calls, if you choose to use the cellular phone while driving, you must not allow yourself to be distracted from the safe operation of your vehicle. Anything, including cellular phone usage, that distracts you from the safe operation of your vehicle increases your risk of an accident.
- Refer to and comply with all state and local laws in your area regarding cellular phone usage while driving.

5-160 Features and controls

NOTE

- If the ignition switch is left in the “ACC” position, the accessory power will automatically turn off after a certain period of time and you will no longer be able to use the Bluetooth® 2.0 interface. The accessory power comes on again if the ignition switch is turned from the “ACC” position. Refer to “ACC power auto-cutout function” on page 5-54.
- The Bluetooth® 2.0 interface cannot be used if the Bluetooth® device has a dead battery or the device power is turned off.
- Hands-free calls will not be possible if your phone does not have service available.
- Some Bluetooth® devices are not compatible with the Bluetooth® 2.0 interface.
- You can confirm the Link System software version by pressing the HANG-UP button 3 times (press and hold 2 times and then press briefly) within 10 seconds.

NOTE

- For detail of the Bluetooth® 2.0 interface, refer to the following website:
[For vehicles sold in U.S.A.]
You can access the Mitsubishi Motors North America website.
[For vehicles sold in Canada and Mexico]
You can access the Mitsubishi Motors website.
Please read and agree to the “Warning about Links to the Web Sites of Other Companies”, the websites mentioned above may connect you to websites other than the Mitsubishi Motors website.
<http://www.mitsubishi-motors.com/en/products/index.html>
- Software updates by cellular phone/digital audio device manufacturers may change/alter device connectivity.

Steering control switch and microphone → P.5-161

Voice recognition function → P.5-163

Useful voice commands → P.5-163

Speaker enrollment function → P.5-165

Connecting the Bluetooth® 2.0 interface and the Bluetooth® device → P.5-166

Operating a music player connected via Bluetooth® → P.5-170

How to make or receive hands-free calls → P.5-171

Phonebook function → P.5-173

Steering control switch and microphone

N00564001138

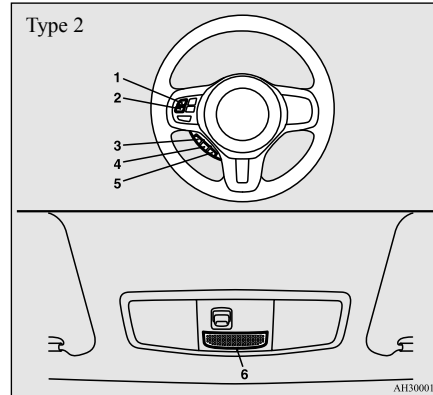
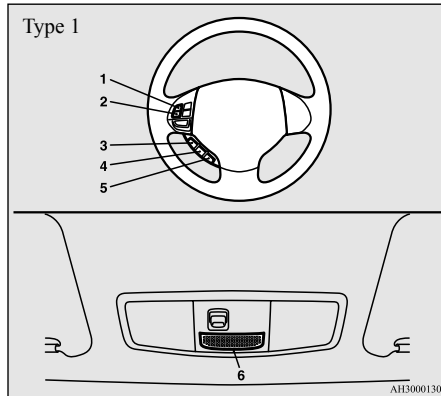

- 1- Volume up button
- 2- Volume down button
- 3- SPEECH button
- 4- PICK-UP button
- 5- HANG-UP button
- 6- Microphone

Volume up button

Press this button to increase the volume.

Volume down button

Press this button to decrease the volume.

Bluetooth® 2.0 interface (if so equipped)

SPEECH button

- Press this button to change to voice recognition mode.
- While the system is in voice recognition mode, “Listening” will appear on the audio display.

NOTE

- On vehicles equipped with the Mitsubishi Multi-Communication System, pressing the SPEECH button will activate the voice recognition mode (a beep will sound when successfully activated). To use the voice recognition of the Bluetooth® 2.0 interface, press the PICK-UP button.
- If you press the button briefly while in voice recognition mode, it will interrupt prompting and allow voice command input. Pressing the button longer will deactivate the voice recognition mode.
- Pressing this button briefly during a call will enable voice recognition and allow voice command input.

PICK-UP button

- Press this button when an incoming call is received to answer the telephone.

5



Bluetooth® 2.0 interface (if so equipped)

NOTE

- When not receiving incoming calls, pressing the PICK-UP button on vehicles equipped with the Mitsubishi Multi-Communication System, will activate the voice recognition of the Bluetooth® 2.0 interface.

5

- When another call is received during a call, press this button to put the first caller on hold and talk to the new caller.
- In such circumstances, you can press the button briefly to switch between callers. You will switch to the first caller and the other caller will be put on hold.
- To establish a three-way call in such situations, press the SPEECH button (except for vehicles with Mitsubishi Multi-Communication System) or PICK-UP button (for vehicles with Mitsubishi Multi-Communication System) to enter voice recognition mode and then say “Join calls.”

HANG-UP button

- Press this button when an incoming call is received to refuse the call.
 - Press this button during a call to end the current call.
- When another call is on hold, you will switch to that call.

5-162 Features and controls



- If this button is pressed in the voice recognition mode, the voice recognition mode will be deactivated.

NOTE

- When you press the SPEECH button (except for vehicles with Mitsubishi Multi-Communication System) or PICK-UP button (for vehicles with Mitsubishi Multi-Communication System) to enter voice recognition mode with a cellular phone paired to the system, current information on the cellular phone, such as “remaining battery life,” “signal strength” or “roaming,” will be displayed on the audio display.*
- *: Some cellular phones will not send this information to the Bluetooth® 2.0 interface.
- Call waiting and three-way calls can be used by the Bluetooth® 2.0 interface, only if it is possible to use those services with your cellular phone.

Microphone

N00575800025

Your voice will be recognized by a microphone in the overhead console, allowing you to make hands-free calls with voice commands.

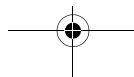

NOTE

- If a cellular phone is within close proximity of the microphone, it may distort the sound quality. In this case, place the cellular phone as far as possible from the microphone.



Voice recognition function

N00564101096

The Bluetooth® 2.0 interface is equipped with a voice recognition function. Simply say voice commands and you can perform various operations and make or receive hands-free calls.

With the Bluetooth® 2.0 interface, voice recognition is possible for US English, North American Spanish, Canadian French and Japanese. The factory setting is “English.”

NOTE

- If the voice command that you say differs from the predefined command or cannot be recognized due to ambient noise or some other reason, the Bluetooth® 2.0 interface will ask you for the voice command again up to 3 times.
- For best performance and further reduction of ambient noise, the vehicle windows should be closed, lower the blower speed and refrain from conversation with your passengers while engaging the voice recognition function.
- Depending on the selected language, some functions may not be available.

Selecting the language

1. Press the SPEECH button (except for vehicles with Mitsubishi Multi-Communication System) or PICK-UP button (for vehicles with Mitsubishi Multi-Communication System).
2. Say “Setup.”
3. Say “Language.”
4. The voice guide will say “Select a language: English, Spanish, French or Japanese.” Say the desired language. (Example: “English”)
5. The voice guide will say “English (Spanish, French or Japanese) selected. Is this correct?” Say “Yes.”
If you say “No,” the system will return to Step 4.

NOTE

- The voice guide will repeat the same message twice. The first message is in the current language, and the second message is in the selected language.
- If many entries are registered in the vehicle phonebook, changing the language will take a longer time.
- Changing the language deletes the mobile phonebook imported to the Bluetooth® 2.0 interface. If you wish to use it, you will have to import it again.

Bluetooth® 2.0 interface (if so equipped)

6. When the voice guide says “English (Spanish, French or Japanese) selected,” the language change process will be completed and the system will return to the main menu.

Useful voice commands

N00564200016

5

Help function

N00564300017

The Bluetooth® 2.0 interface is equipped with a help function.

If you say “Help” when the system is waiting for a voice command input, the system will tell you a list of the commands that can be used under the circumstances.

Canceling

N00564400018

There are 2 cancel functions.

If you are at the main menu, say “Cancel” to exit from the Bluetooth® 2.0 interface.

If you are anywhere else within the system, say “Cancel” to return to the main menu.

Confirmation function setting

N00564501029

The Bluetooth® 2.0 interface is equipped with a confirmation function.

Bluetooth® 2.0 interface (if so equipped)

With the confirmation function activated, you are given more opportunities than normal to confirm a command when making various settings to the Bluetooth® 2.0 interface. This allows you to decrease the possibility that a setting is accidentally changed.

The confirmation function can be turned on or off by following the steps below.

5

1. Press the SPEECH button (except for vehicles with Mitsubishi Multi-Communication System) or PICK-UP button (for vehicles with Mitsubishi Multi-Communication System).
2. Say "Setup."
3. Say "Confirmation prompts."
4. The voice guide will say "Confirmation prompts are <on/off>. Would you like to turn confirmation prompts <off/on>." Answer "Yes" to change the setting or answer "No" to keep the current setting.
5. The voice guide will say "Confirmation prompts are <off/on>" and then the system will return to the main menu.

Security function

N00564601118

It is possible to use a passcode as a security function by setting a passcode of your choice for the Bluetooth® 2.0 interface.

When the security function is turned on, it is necessary to make a voice input of a 4-digit

5-164 Features and controls

passcode in order to use all functions of the Bluetooth® 2.0 interface, except for reception.

Setting the passcode

Use the following procedure to turn on the security function by setting a passcode.

1. Press the SPEECH button (except for vehicles with Mitsubishi Multi-Communication System) or PICK-UP button (for vehicles with Mitsubishi Multi-Communication System).
2. Say "Setup."
3. Say "Passcode."
4. The voice guide will say "Passcode is disabled. Would you like to enable it?" Answer "Yes."
Answer "No" to cancel the setting of the passcode and return to the main menu.
5. The voice guide will say "Please say a 4-digit passcode. Remember this passcode. It will be required to use this system."
Say a 4-digit number which you want to set as a passcode.
6. For confirmation purposes, the voice guide will say "Passcode <4-digit passcode>. Is this correct?" Answer "Yes."
Answer "No" to return to the passcode input in Step 5.

7. When the registration of the passcode is completed, the voice guide will say "Passcode is enabled" and the system will return to the main menu.

NOTE

- Passcode will be required to access the system after the next ignition cycle.
- It is required for a little time after engine stop that the entered passcode is actually recorded in the system. If the ignition switch is made to "ACC" or "ON" or the engine is started immediately after engine stop, there is a case when the entered passcode is not recorded in the system. At this time, please try to enter the passcode again.

Entering the passcode

If a passcode has been set and the security function is enabled, the voice guide will say "Hands-free system is locked. State the passcode to continue" when the SPEECH button (except for vehicles with Mitsubishi Multi-Communication System) or PICK-UP button (for vehicles with Mitsubishi Multi-Communication System) is pressed to enter voice recognition mode. Say the 4-digit passcode number to enter the passcode.

If the entered passcode is wrong, the voice guide will say "<4-digit passcode>, Incorrect

passcode. Please try again.” Enter the correct passcode.

NOTE

- You can reenter the passcode as many times as you want.
- If you have forgotten your passcode, say “Cancel” to quit the voice input mode and then check with an authorized Mitsubishi Motors dealer.

Disabling the passcode

Use the following procedure to turn off the security function by disabling the passcode.

NOTE

- System must be unlocked to disable the passcode.

1. Press the SPEECH button (except for vehicles with Mitsubishi Multi-Communication System) or PICK-UP button (for vehicles with Mitsubishi Multi-Communication System).
2. Say “Setup.”
3. Say “Passcode.”
4. The voice guide will say “Passcode is enabled. Would you like to disable it?” Answer “Yes.”
Answer “No” to cancel the disabling of the passcode and return to the main menu.

5. When the disabling of the passcode is completed, the voice guide will say “Passcode is disabled” and the system will return to the main menu.

Speaker enrollment function

N00564700011

The Bluetooth® 2.0 interface can use the speaker enrollment function to create a voice model for one person per language.

This makes it easier for the Bluetooth® 2.0 interface to recognise voice commands said by you.

You can turn a voice model registered with the speaker enrollment function on and off whenever you want.

Speaker enrollment

N00564801080

It takes about 2 to 3 minutes to complete the speaker enrollment process.

To ensure the best results, run through the process while in the driver’s seat, in an environment that is as quiet as possible (when there is no rain or strong winds and the vehicle windows are closed). Please turn off your phone while in speaker enrollment to prevent interruption of the process.

Use the following procedure for speaker enrollment.

Bluetooth® 2.0 interface (if so equipped)

1. Stop your vehicle in a safe area, put the shift lever (manual transaxle) in the “N” (Neutral) position, or the selector lever {continuously variable transmission (CVT)} or gearshift lever (Twin Clutch SST) in the “P”(PARK) position, and then pull the parking brake lever.

NOTE

- Speaker enrollment is not possible unless the vehicle is parked. Make sure you park the vehicle in a safe area before attempting speaker enrollment.

2. Press the SPEECH button (except for vehicles with Mitsubishi Multi-Communication System) or PICK-UP button (for vehicles with Mitsubishi Multi-Communication System).
3. Say “Voice training.”
4. The voice guide will say “This operation must be performed in a quiet environment while the vehicle is stopped. See the owner’s manual for the list of required training phrases. Press and release the SPEECH button when you are ready to begin. Press the HANG-UP button to cancel at any time.”
Press the SPEECH button to start the speaker enrollment process.

5

Bluetooth® 2.0 interface (if so equipped)

5

NOTE

- If you do not start the speaker enrollment process within 3 minutes after pressing the SPEECH button, the speaker enrollment function will time out. The voice guide will say “Speaker enrollment has timed out.” The system will then beep and the voice recognition mode will be deactivated.

5. The voice guide will prompt for phrase 1. Repeat the corresponding phrase listed in table “Enrollment commands” on page 5-181.

The system will register your voice and then move on to the registration of the next command. Continue the process until all phrases have been registered.

NOTE

- To repeat the most recent voice training command, press and release the SPEECH button.
- If you press the HANG-UP button anytime during the process, the system will beep and stop the speaker enrollment process.

6. When all enrollment commands have been read out, the voice guide will say “Speaker enrollment is complete.” The system will then end the speaker enrollment process and return to the main menu.

5-166 Features and controls

NOTE

- Completing the speaker enrollment process will turn on the voice model automatically.
- The commands “Help” and “Cancel” will not work in this mode.

Enabling and disabling the voice model and retraining

N00564901065

You can turn a voice model registered with the speaker enrollment function on and off whenever you want.

You can also retrain the system.

Use the following procedure to perform these actions.

1. Press the SPEECH button (except for vehicles with Mitsubishi Multi-Communication System) or PICK-UP button (for vehicles with Mitsubishi Multi-Communication System).
2. Say “Voice training.”
3. If you have completed a speaker enrollment process once already, the voice guide will say either “Enrollment is enabled. Would you like to disable or retrain?” or “Enrollment is disabled. Would you like to enable or retrain?”

4. When enrollment is “enabled,” the voice model is on; when enrollment is “disabled,” the voice model is off. Say the command that fits your needs.

Say “Retrain” to start the speaker enrollment process and recreate a new voice model. (Refer to “Speaker enrollment” on page 5-165.)

Connecting the Bluetooth® 2.0 interface and Bluetooth® device

N00565001265

Before you can make or receive hands-free calls or play music using the Bluetooth® 2.0 interface function, you must pair the Bluetooth® device and Bluetooth® 2.0 interface.

NOTE

- Pairing is required only when the device is used for the first time. Once the device has been paired with the Bluetooth® 2.0 interface, all you need is to bring the device into the vehicle next time and the device will connect to the Bluetooth® 2.0 interface automatically (if supported by the device).

Up to 7 Bluetooth® devices can be paired with the Bluetooth® 2.0 interface.

If multiple paired Bluetooth® devices are available in the vehicle, the cellular phone or

music player most recently connected is automatically connected to the Bluetooth® 2.0 interface.

You can also change a Bluetooth® device to be connected.

To pair

To pair a Bluetooth® device with the Bluetooth® 2.0 interface, follow the steps below.

1. Stop your vehicle in a safe area, put the shift lever (manual transaxle) in the “N” (Neutral) position, or the selector lever {continuously variable transmission (CVT)} or gearshift lever (Twin Clutch SST) in the “P” (PARK) position, and then pull the parking brake lever.

NOTE

- You cannot pair any Bluetooth® device with the Bluetooth® 2.0 interface unless the vehicle is parked. Before pairing a Bluetooth® device with the Bluetooth® 2.0 interface, confirm that the vehicle is parked in a safe location.

2. Press the SPEECH button (except for vehicles with Mitsubishi Multi-Communication System) or PICK-UP button (for vehicles with Mitsubishi Multi-Communication System).
3. Say “Setup.”
4. Say “Pairing Options.”
5. The voice guide will say “Select one of the following: pair, edit, delete, or list.” Say “Pair.”

NOTE

- If 7 devices have already been paired, the voice guide will say “Maximum devices paired” and then the system will end the pairing process. To register a new device, delete one device and then repeat the pairing process. (Refer to “Deleting a device” on page 5-168.)

6. The voice guide will say “Please say a 4-digit pairing code.” Say a 4-digit number. When the confirmation function is on, the system will confirm whether the number said is acceptable. Answer “Yes.” Answer “No” to return to pairing code selection.

Bluetooth® 2.0 interface (if so equipped)

NOTE

- Some Bluetooth® devices require a specific pairing code. Please refer to the device manual for pairing code requirements.
- The pairing code entered here is only used for the Bluetooth® connection certification. It is any 4-digit number the user would like to select. Remember the pairing code as it needs to be keyed into the Bluetooth® device later in the pairing process. Depending on the connection settings of the Bluetooth® device, this code may have to be entered each time you connect the Bluetooth® device to the Bluetooth® 2.0 interface. For the default connection settings, refer to the instructions for the device.

7. The voice guide will say “Start pairing procedure on the device. See the device manual for instructions.” Enter in the Bluetooth® device the 4-digit number you have registered in Step 6.

NOTE

- Depending on the Bluetooth® device, it may take a few minutes to pair it with the Bluetooth® 2.0 interface.

Bluetooth® 2.0 interface (if so equipped)

5

NOTE

- If the Bluetooth® 2.0 interface cannot recognize the Bluetooth® device, the voice guide will say “Pairing has timed out” and the pairing process will be cancelled. Confirm that the device you are pairing supports Bluetooth®, and try pairing it again.
- If you enter the wrong number, the voice guide will say “Pairing failed” and the pairing process will be cancelled. Confirm the number is right, and try pairing it again.

8. The voice guide will say “Please say the name of the device after the beep.” You can assign a desired name for the Bluetooth® device and register it as a device tag. Say the name you want to register after the beep.

NOTE

- When the confirmation function is on, after repeating the device tag you have said, the voice guide will ask “Is this correct?” Answer “Yes.” To change the device tag, answer “No” and then say the device tag again.

9. The voice guide will say “Pairing complete,” and the pairing process will end.

Selecting a device

N00565101064

If multiple paired Bluetooth® devices are available in the vehicle, the cellular phone or music player most recently connected is automatically connected to the Bluetooth® 2.0 interface.

You can connect to the other cellular phone or music player by following setting change procedures.

To select a cellular phone

1. Press the SPEECH button (except for vehicles with Mitsubishi Multi-Communication System) or PICK-UP button (for vehicles with Mitsubishi Multi-Communication System).
2. Say “Setup.”
3. Say “Select phone.”
4. After the voice guide says “Please say,” the numbers of the cellular phones and device tags of corresponding cellular phones will be read out in order, starting with the cellular phone that has been most recently connected. Say the number of the cellular phone that you want to connect to.

When the confirmation function is on, the system will ask you again whether the phone that you want to connect to is correct. Answer “Yes” to continue and connect to the cellular phone.

Answer “No,” and the voice guide will say “Please say.” Say the number of the phone that you want to connect to.

NOTE

- You can connect to a phone at any time by pressing the SPEECH button and saying the number, even before all of the paired numbers and device tags of corresponding cellular phones are read out by the system.

5. The selected phone will be connected to the Bluetooth® 2.0 interface. The voice guide will say “<device tag> selected” and then the system will return to the main menu.

To select a music player

1. Press the SPEECH button (except for vehicles with Mitsubishi Multi-Communication System) or PICK-UP button (for vehicles with Mitsubishi Multi-Communication System).
2. Say “Setup.”
3. Say “Select music player.”

4. After the voice guide says “Please say,” the numbers of the music players and device tags of corresponding music players will be read out in order, starting with the music player that has been most recently connected.

Say the number of the music player that you want to connect to.

When the confirmation function is on, the system will ask you again whether the music player that you want to connect to is correct. Answer “Yes” to continue and connect to the music player.

Answer “No,” and the voice guide will say “Please say.” Say the number of the music player that you want to connect to.

NOTE

- You can connect to a music player at any time by pressing the SPEECH button and saying the number, even before all of the paired numbers and device tags of corresponding music players are read out by the system.

5. The selected music player will be connected to the Bluetooth® 2.0 interface.

The voice guide will say “<device tag> selected” and then the system will return to the main menu.

Deleting a device

Use the following procedure to delete a paired Bluetooth® device from the Bluetooth® 2.0 interface.

1. Press the SPEECH button (except for vehicles with Mitsubishi Multi-Communication System) or PICK-UP button (for vehicles with Mitsubishi Multi-Communication System).
2. Say “Setup.”
3. Say “Pairing Options.”
4. The voice guide will say “Select one of the following: pair, edit, delete, or list.” Say “Delete.”
5. After the voice guide says “Please say,” the numbers of the devices and device tags of corresponding devices will be read out in order, starting with the device that has been most recently connected. After it completes reading all pairs, the voice guide will say “or all.” Say the number of the device that you want to delete from the system. If you want to delete all paired phones from the system, say “All.”
6. For confirmation purposes, the voice guide will say “Deleting <device tag> <number>. Is this correct?” or “Deleting all devices. Is this correct?” Answer “Yes” to delete the phone(s).

Bluetooth® 2.0 interface (if so equipped)

Answer “No,” the system will return to Step 4.

7. The voice guide will say “Deleted,” and then the system will end the device deletion process.

NOTE

- If the device deletion process fails for some reason, the voice guide will say “Delete failed” and then the system will cancel deleting the device.

5

To check a paired Bluetooth® device

N00565201023

You can check a paired Bluetooth® device by following the steps below.

1. Press the SPEECH button (except for vehicles with Mitsubishi Multi-Communication System) or PICK-UP button (for vehicles with Mitsubishi Multi-Communication System).
2. Say “Setup.”
3. Say “Pairing Options.”
4. The voice guide will say “Select one of the following: pair, edit, delete, or list.” Say “List.”

Bluetooth® 2.0 interface (if so equipped)

5

5. The voice guide will read out device tags of corresponding devices in order, starting with the Bluetooth® device that has been most recently connected.
6. After the device tags of all paired Bluetooth® devices have been read, the system will say “End of list, would you like to start from the beginning?”

To hear the list again from the beginning, answer “Yes.”

When you are done, answer “No” to return to the main menu.

NOTE

- If you press and release the SPEECH button and say “Continue” or “Previous” while the list is being read, the system will advance or rewind the list.
Say “Continue” to proceed to the device with the next highest number or “Previous” to return to the phone with the previous number.
- You can change the device tag by pressing and releasing the SPEECH button and then saying “Edit” while the list is being read.
- You can change the phone to be connected by pressing and releasing the SPEECH button and then saying “Select phone” while the list is being read.
- You can change the music player to be connected by pressing and releasing the SPEECH button and then saying “Select music player” while the list is being read.

5-170 Features and controls

Changing a device tag

N00565301024

You can change the device tag of a paired cellular phone or music player.

Follow the steps below to change a device tag.

1. Press the SPEECH button (except for vehicles with Mitsubishi Multi-Communication System) or PICK-UP button (for vehicles with Mitsubishi Multi-Communication System).
2. Say “Setup.”
3. Say “Pairing Options.”
4. The voice guide will say “Select one of the following: pair, edit, delete, or list.” Say “Edit.”
5. The voice guide will say “Please say,” and read out the numbers of the Bluetooth® devices and device tags of corresponding devices in order, starting with the Bluetooth® that has been most recently connected.

After all paired device tags have been read, the voice guide will say “Which device, please?” Say the number of the device tag you want to change.

NOTE

- You can press and release the SPEECH button while the list is being read, and immediately say the number of the device tag you want to change.

6. The voice guide will say “New name, please.” Say the name you want to register as a new device tag.

When the confirmation function is on, the voice guide will say “<New device tag>. Is this correct?” Answer “Yes.”

Answer “No,” you can say the new device tag you want to register again.

7. The device tag is changed.

When the change is complete, the voice guide will say “New name saved” and then the system will return to the main menu.

Operating a music player connected via Bluetooth®

N00565401083

For the operation of a music player connected via Bluetooth®, refer to the following sections.

For vehicles equipped with the AM/FM radio/CD player

Refer to “Listen to Bluetooth Audio” on page 7-52.

For vehicles equipped with the DISPLAY AUDIO

Refer to the separate owner’s manual.

For vehicles equipped with the Mitsubishi Multi-Communication System

Refer to the separate owner’s manual.

How to make or receive hands-free calls

N00565500074

You can make or receive hands-free calls using a Bluetooth® compatible cellular phone connected to the Bluetooth® 2.0 interface. You can also use the phonebooks in the Bluetooth® 2.0 interface to make calls without dialing telephone numbers.

To make a call P.5-171
Send function P.5-173
Receiving calls P.5-173
Mute function P.5-173

Switching between hands-free mode and private mode P.5-173

NOTE

- Hands-free calls may not operate correctly when you place or receive the call directly from your cellular phone, instead of using the Bluetooth® 2.0 interface.

To make a call

N00565601072

You can make a call in the following 3 ways using the Bluetooth® 2.0 interface: Making a call by saying a telephone number, making a call using the Bluetooth® 2.0 interface’s phonebook, and making a call by redialing.

Making a call by using the telephone number

You can make a call by saying the telephone number.

1. Press the SPEECH button (except for vehicles with Mitsubishi Multi-Communication System) or PICK-UP button (for vehicles with Mitsubishi Multi-Communication System).
2. Say “Dial.”

Bluetooth® 2.0 interface (if so equipped)

3. After the voice guide says “Number please,” say the telephone number.
4. The voice guide will say “Dialing <number recognized>.”

The Bluetooth® 2.0 interface will then make the call.

When the confirmation function is on, the system will confirm the telephone number again. To continue with that number, answer “Yes.”

To change the telephone number, answer “No.” The system will say “Number please” then say the telephone number again.

5

NOTE

- In the case of English, the system will recognise both “zero” and “oh” (Letter “o”) for the number “0.”
- The Bluetooth® 2.0 interface supports numbers (0 to 9) and characters (+, # and *).
- The maximum supported telephone number length is as follows:
 - International telephone number: + and telephone numbers (to 18 digits).
 - Except for international telephone number: telephone numbers (to 19 digits).

Bluetooth® 2.0 interface (if so equipped)

Making a call using a phonebook

You can make calls using the vehicle phonebook or mobile phonebook of the Bluetooth® 2.0 interface.

For details on the phonebooks, refer to “Phonebook function” on page 5-173.

5

1. Press the SPEECH button (except for vehicles with Mitsubishi Multi-Communication System) or PICK-UP button (for vehicles with Mitsubishi Multi-Communication System).
2. Say “Call.”

NOTE

- If you say “Call” when the vehicle phonebook and the mobile phonebook are empty, the voice guide will say “The vehicle phonebook is empty. Would you like to add a new entry now?”
Answer “Yes,” and the voice guide will say “Entering the phonebook - new entry menu.” You can now create data in the vehicle phonebook.
Answer “No,” the system will return to the main menu.

3. After the voice guide says “Name please,” say the name you want to call, from those registered in the phonebook.

4. If there is only 1 match, the system will proceed to Step 5.

If there are 2 or more matches, the voice guide will say “More than one match was found, would you like to call <returned name>.” If that person is the one you want to call, answer “Yes.”

Answer “No,” the name of the next matching person will be uttered by the voice guide.

NOTE

- If you say “No” to all names read by the system, the voice guide will say “Name not found, returning to main menu” and the system will return to the main menu.

5. If only 1 telephone number is registered under the name you just said, the voice guide will proceed to Step 6.

If 2 or more telephone numbers are registered that match the name you just said, the voice guide will say “Would you like to call <name> at [home], [work], [mobile], or [other]?” Select the location to call.

NOTE

- If the name you selected has matching data in the vehicle phonebook but no telephone number is registered under the selected location, the voice guide will say “{home/work/mobile/other} not found for <name>. Would you like to add location or try again?”
Say “Try again,” and the system will return to Step 3.
Say “Add location” and you can register an additional telephone number under the selected location.
- If the name you selected has matching data in the mobile phonebook but no telephone number is registered under the selected location, the voice guide will say “{home/work/mobile/other} not found for <name>. Would you like to try again?”
Answer “Yes,” and the system will return to Step 3.
Answer “No,” and the call making will be cancelled. Start over again from Step 1.

6. The voice guide will say “Calling <name> <location>” and then the system will dial the telephone number.

NOTE

- When the confirmation function is on, the system will check if the name and location of the receiver are correct. If the name is correct, answer “Yes.”
To change the name or location to call, answer “No.” The system will return to Step 3.

Redialing

You can redial the last number called, based on the history of dialed calls in the paired cellular phone.

Use the following procedure to redial.

1. Press the SPEECH button (except for vehicles with Mitsubishi Multi-Communication System) or PICK-UP button (for vehicles with Mitsubishi Multi-Communication System).
2. Say “Redial.”

Send function

N00565700018

During a call, press the SPEECH button to enter voice recognition mode, then say “<numbers> SEND” to generate DTMF tones.

For example, if during a call you need to simulate the pressing of a phone button as a

response to an automated system, press the SPEECH button and speak “1 2 3 4 pound send” and the 1234# will be sent via your cellular phone.

Receiving calls

N00565800019

If an incoming phone call is received while the ignition switch is in the “ACC” or “ON” position, the audio system will be automatically turned on and switched to the incoming call, even when the audio system was originally off.

The voice guide announcement for the incoming call will be output from the front passenger’s seat speaker.

If the CD player or radio was playing when the incoming call was received, the audio system will mute the sound from the CD player or radio and output only the incoming call.

To receive the call, press the PICK-UP button on the steering wheel control switch.

When the call is over, the audio system will return to its previous state.

Mute function

N00565900010

At any time during a call, you can mute the vehicle microphone.

Bluetooth® 2.0 interface (if so equipped)

Pressing the SPEECH button and then saying “Mute” during a call will turn ON the mute function and mute the microphone.

Saying “Mute off” in the same way will turn off the mute function and cancel the mute on the microphone.

Switching between hands-free mode and private mode

N00566600014

The Bluetooth® 2.0 interface can switch between hands-free mode (hands-free calls) and private mode (calls using cellular phone).

If you press the SPEECH button and say “Transfer call” during a hands-free call, you can stop the hands-free mode and talk in private mode.

To return to hands-free mode, press the SPEECH button again and say “Transfer call.”

Phonebook function

N00566000018

The Bluetooth® 2.0 interface has 2 types of unique phonebooks that are different from the phonebook stored in the cellular phone. They are the vehicle phonebook and the mobile phonebook.

Bluetooth® 2.0 interface (if so equipped)

These phonebooks are used to register telephone numbers and make calls to desired numbers via voice recognition function.

NOTE

- Disconnecting the battery cable will not delete information registered in the phonebook.

5

Vehicle phonebook

N00566101117

This phonebook is used when making calls with the voice recognition function.

Up to 32 names can be registered in the vehicle phonebook per language.

Also, each entry has 4 locations associated with: home, work, mobile and other. You can register one telephone number for each location.

You can register a desired name as a name for any phonebook entry registered in the vehicle phonebook.

Names and telephone numbers can be changed later on.

The vehicle phonebook can be used with all paired cellular phones.

■ To register a telephone number in the vehicle phonebook

N00580500020

You can register a telephone number in the vehicle phonebook in the following 2 ways: Reading out a telephone number, and selecting and transferring 1 phonebook entry from the phonebook of the cellular phone.

■ To register by reading out a telephone number

N00580600021

1. Press the SPEECH button (except for vehicles with Mitsubishi Multi-Communication System) or PICK-UP button (for vehicles with Mitsubishi Multi-Communication System).
2. Say "Phonebook."
3. The voice guide will say "Select one of the following: new entry, edit number, edit name, list names, delete, erase all, or import contact." Say "New entry."
4. The voice guide will say "Name please." Say your preferred name to register it.

NOTE

- If the maximum number of entries are already registered, the voice guide will say "The phonebook is full. Would you like to delete a name?" Say "Yes" if you want to delete a registered name. If you say "No," the system will return to the main menu.

5. When the name has been registered, the voice guide will say "home, work, mobile, or other?" Say the location for which you want to register a telephone number.

NOTE

- When the confirmation function is on, the voice guide will say "<Location>. Is this correct?" Answer "Yes." Answer "No" to return to location selection in Step 5. If a telephone number has been registered for the selected location, the voice guide will say "The current number is <telephone number>, number please." If you do not want to change the telephone number, say "cancel" or the original number to keep it registered.

6. The voice guide will say "Number please." Say the telephone number to register it.

 **NOTE**

- In the case of English, the system will recognise both “zero” and “oh” (Letter “o”) for the number “0.”

7. The voice guide will repeat the telephone number you have just read, and then register the number.

When the telephone number has been registered, the voice guide will say “Number saved. Would you like to add another number for this entry?”

To add another telephone number for a new location for the current entry, answer “Yes.” The system will return to location selection in Step 5.

Answer “No” to end the registration process and return to the main menu.

 **NOTE**

- When the confirmation function is on, after repeating the telephone number you have read, the voice guide will ask “Is this correct?” Answer “Yes.” Answer “No” to return to telephone number registration in step 6.

■ **To select and transfer one phonebook entry from the phonebook of the cellular phone**

N00580700022

You can select 1 phonebook entry from the phonebook of the cellular phone and register it in the vehicle phonebook.

 **NOTE**

- Transfer is not permitted unless the vehicle is parked. Before transferring, make sure that the vehicle is parked in a safe location.
- All or part of data may not be transferred, even when the cellular phone supports Bluetooth®, depending on the compatibility of the device.
- The maximum supported telephone number length is 19 digits. Any telephone number of 20 digits or more will be truncated to the first 19 digits.
- If telephone numbers contain characters other than 0 to 9, *, # or +, these characters are deleted before the transfer.
- For the connection settings on the cellular phone side, refer to the instructions for the cellular phone.

1. Press the SPEECH button (except for vehicles with Mitsubishi Multi-Communication System) or PICK-UP button (for vehicles with Mitsubishi Multi-Communication System).

Bluetooth® 2.0 interface (if so equipped)

2. Say “Phonebook.”
3. The voice guide will say “Select one of the following: new entry, edit number, edit name, list names, delete, erase all, or import contact.” Say “Import contact.”
4. The voice guide will say “Would you like to import a single entry or all contacts?” Say “Single entry.”

The Bluetooth® 2.0 interface will become ready to receive transferred phonebook data.

 **NOTE**

- If the maximum number of entries are already registered, the voice guide will say “The phonebook is full. Would you like to delete a name?” Say “Yes” if you want to delete a registered name. If you say “No,” the system will return to the main menu.

5. After the voice guide says “Ready to receive a contact from the phone. Only a home, a work, and a mobile number can be imported,” the Bluetooth® 2.0 interface will receive the phonebook data from the Bluetooth® compatible cellular phone.

5

Bluetooth® 2.0 interface (if so equipped)

- Operate the Bluetooth® compatible cellular phone to set it up so that the phonebook entry you want to register in the vehicle phonebook can be transferred to the Bluetooth® 2.0 interface.

5

NOTE

- If the Bluetooth® 2.0 interface cannot recognise the Bluetooth® compatible cellular phone or the connection takes too much time, the voice guide will say “Import contact has timed out” and then the system will cancel the registration. In such case, start over again from Step 1.
- Pressing the HANG-UP button or pressing and holding the SPEECH button will cancel the registration.

- When the reception is complete, the voice guide will say “<Number of telephone numbers that had been registered in the import source> numbers have been imported. What name would you like to use for these numbers?”
Say the name you want to register for this phonebook entry.

NOTE

- If the entered name is already used for other phonebook entry or similar to a name used for other phonebook entry, that name cannot be registered.

5-176 Features and controls

- The voice guide will say “Adding <name>.”

When the confirmation function is on, the system will ask if the name is correct. Answer “Yes.”

Answer “No,” the voice guide will say “Name please.” Register a different name.

- The voice guide will say “Numbers saved.”

- The voice guide will say “Would you like to import another contact?”

Answer “Yes” if you want to continue with the registration. You can continue to register a new phonebook entry from Step 5.

Answer “No,” the system will return to the main menu.

■ To change the content registered in the vehicle phonebook

N00579800023

You can change or delete a name or telephone number registered in the vehicle phonebook.

You can also listen to the list of names registered in the vehicle phonebook.

NOTE

- The system must have at least one entry.

◆ Editing a telephone number

N00579900024

- Press the SPEECH button (except for vehicles with Mitsubishi Multi-Communication System) or PICK-UP button (for vehicles with Mitsubishi Multi-Communication System).
- Say “Phonebook.”
- The voice guide will say “Select one of the following: new entry, edit number, edit name, list names, delete, erase all, or import contact”. Say “Edit number.”
- The voice guide will say “Please say the name of the entry you would like to edit, or say list names.” Say the name of the phonebook entry you want to edit.

NOTE

- Say “List names,” and the names registered in the phonebook will be read out in order. Refer to “Listening to the list of registered names” on page 5-177.

- The voice guide will say “Home, work, mobile or other?” Select and say the location where the telephone number you want to change or add is registered.

When the confirmation function is on, the system will check the target name and location again. Answer “Yes” if you want to continue with the editing.

Answer “No,” the system will return to Step 3.

- The voice guide will say “Number, please.” Say the telephone number you want to register.

NOTE

- If the telephone number is already registered in the selected location, the voice guide will say “The current number is <current number>. New number, please.” Say a new telephone number to change the current number.

- The voice guide will repeat the telephone number.

When the confirmation function is on, the system will ask if the number is correct. Answer “Yes.”

Answer “No,” the system will return to the Step 3.

- Once the telephone number is registered, the voice guide will say “Number saved” and then the system will return to the main menu.

NOTE

- If the location where a telephone number was already registered has been overwritten with a new number, the voice guide will say “Number changed” and then the system will return to the main menu.

◆ Editing a name

N00580100026

- Press the SPEECH button (except for vehicles with Mitsubishi Multi-Communication System) or PICK-UP button (for vehicles with Mitsubishi Multi-Communication System).
- Say “Phonebook.”
- The voice guide will say “Select one of the following: new entry, edit number, edit name, list names, delete, erase all, or import contact.” Say “Edit name.”
- The voice guide will say “Please say the name of the entry you would like to edit, or say list names.” Say the name you want to edit.

NOTE

- Say “List names,” and the names registered in the phonebook are read out in order. Refer to “Listening to the list of registered names” on page 5-177.

- The voice guide will say “Changing <name>.”

When the confirmation function is on, the system will check if the name is correct. Answer “Yes” if you want to continue with the editing based on this information. Answer “No,” the system will return to Step 4.

Bluetooth® 2.0 interface (if so equipped)

- The voice guide will say “Name please.” Say the new name you want to register.
- The registered name will be changed. When the change is complete, the system will return to the main menu.

◆ Listening to the list of registered names

N00580200027

5

- Press the SPEECH button (except for vehicles with Mitsubishi Multi-Communication System) or PICK-UP button (for vehicles with Mitsubishi Multi-Communication System).
- Say “Phonebook.”
- The voice guide will say “Select one of the following: new entry, edit number, edit name, list names, delete, erase all, or import contact.” Say “List names.”
- Bluetooth® 2.0 interface will read out the entries in the phonebook in order.
- When the voice guide is done reading the list, it will say “End of list, would you like to start from the beginning?” When you want to check the list again from the beginning, answer “Yes.” When you are done, answer “No” to return to the previous or main menu.

Bluetooth® 2.0 interface (if so equipped)

5

 **NOTE**

- You can call, edit or delete a name that is being read out.
Press the SPEECH button and say “Call” to call the name, “Edit name” to edit it, or “Delete” to delete it.
The system will beep and then execute your command.
- If you press the SPEECH button and say “Continue” or “Previous” while the list is being read, the system will advance or rewind the list. Say “Continue” to proceed to the next entry or “Previous” to return to the previous entry.

◆ **Deleting a telephone number**

N00580300028

- Press the SPEECH button (except for vehicles with Mitsubishi Multi-Communication System) or PICK-UP button (for vehicles with Mitsubishi Multi-Communication System).
- Say “Phonebook.”
- The voice guide will say “Select one of the following: new entry, edit number, edit name, list names, delete, erase all, or import contact.” Say “Delete.”

- The voice guide will say “Please say the name of the entry you would like to delete, or say list names.” Say the name of the phonebook entry in which the telephone number you want to delete is registered.

 **NOTE**

- Say “List names,” and the names registered in the phonebook are read out in order. Refer to “Listening to the list of registered names” on page 5-177.

- If only one telephone number is registered in the selected phonebook entry, the voice guide will say “Deleting <name> <location>.”

If multiple telephone numbers are registered in the selected phonebook entry, the voice guide will say “Would you like to delete [home], [work], [mobile], [other], or all?”

Select the location to delete, and the voice guide will say “Deleting <name> <location>.”

 **NOTE**

- To delete the telephone numbers from all locations, say “All.”

- The system will ask if you really want to delete the selected telephone number(s) to go ahead with the deletion, answer “Yes.” Answer “No,” the system will cancel deleting the telephone number(s) and then return to Step 4.

- When the telephone number deletion is complete, the voice guide will say “<name> <location> deleted” and then the system will return to the main menu.
If all locations are deleted, the system will say “<name> and all locations deleted” and the name will be removed from the phonebook. If numbers still remain under the entry, the name will retain the other associated numbers.

■ **Erasing the phonebook**

N00580400029

You can delete all registered information from the vehicle phonebook.

- Press the SPEECH button (except for vehicles with Mitsubishi Multi-Communication System) or PICK-UP button (for vehicles with Mitsubishi Multi-Communication System).
- Say “Phonebook.”
- The voice guide will say “Select one of the following: new entry, edit number, edit name, list names, delete, erase all, or import contact.” Say “Erase all.”

4. For confirmation purposes, the voice guide will ask “Are you sure you want to erase everything from your hands-free system phonebook?” Answer “Yes.”

Answer “No” to cancel the deletion of all registered information in the phonebook and return to the main menu.

5. The voice guide will say “You are about to delete everything from your hands-free system phonebook. Do you want to continue?” Answer “Yes” to continue.

Answer “No” to cancel the deletion of all registered information in the phonebook and return to the main menu.

6. The voice guide will say “Please wait, erasing the hands-free system phonebook” and then the system will delete all data in the phonebook.

When the deletion is complete, the voice guide will say “Hands-free system phonebook erased” and then the system will return to the main menu.

Mobile phonebook

N00566201062

All entries in the phonebook stored in the cellular phone can be transferred in a batch and registered in the mobile phonebook.

Up to 7 mobile phonebooks, each containing up to 1,000 names, can be registered.

The Bluetooth® 2.0 interface automatically converts from text to voice the names registered in the transferred phonebook entries, and creates names.

NOTE

- Only the mobile phonebook transferred from the connected cellular phone can be used with that cellular phone.
- You cannot change the names and telephone numbers in the phonebook entries registered in the mobile phonebook. You cannot select and delete specific phonebook entries, either. To change or delete any of the above, change the applicable information in the source phonebook of the cellular phone and then transfer the phonebook again.

To import a devices phonebook

Follow the steps below to transfer to the mobile phonebook the phonebook stored in the cellular phone.

NOTE

- Transfer should be completed while the vehicle is parked. Before transferring, make sure that the vehicle is parked in a safe location.
- The already stored phonebook in the mobile phonebook is overwritten by the stored phonebook in the cellular phone.

Bluetooth® 2.0 interface (if so equipped)

NOTE

- All or part of data may not be transferred, even when the cellular phone supports Bluetooth®, depending on the compatibility of the device.
- Only a home, a work, and a mobile number can be imported.
- The maximum supported telephone number length is 19 digits. Any telephone number of 20 digits or more will be truncated to the first 19 digits.
- If telephone numbers contain characters other than 0 to 9, *, # or +, these characters are deleted before the transfer.
- For the connection settings on the cellular phone side, refer to the instructions for the cellular phone.

5

1. Press the SPEECH button (except for vehicles with Mitsubishi Multi-Communication System) or PICK-UP button (for vehicles with Mitsubishi Multi-Communication System).

2. Say “Phonebook.”

3. The voice guide will say “Select one of the following: new entry, edit number, edit name, list names, delete, erase all, or import contact.” Say “Import contact.”

4. The voice guide will say “Would you like to import a single entry or all contacts?” Say “All contacts.”

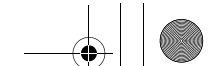

Bluetooth® 2.0 interface (if so equipped)

5. The voice guide will say “Importing the contact list from the mobile phonebook. This may take several minutes to complete. Would you like to continue?” Answer “Yes,” transferring to the mobile phonebook the phonebook stored in the cellular phone will start.
- Answer “No,” the system will return to the main menu.

5

NOTE

- The transfer may take some time to complete depending on the number of contacts.
- If the Bluetooth® 2.0 interface could not be connected to the Bluetooth® compatible cellular phone, the voice guide will say “Unable to transfer contact list from phone” and then the system will return to the main menu.
- If you press the HANG-UP button or press and hold the SPEECH button during the data transfer, the transfer will be cancelled and the system will return to the main menu.
- If an error occurs during the data transfer, all transfer will be cancelled and the voice guide will say “Unable to complete the phonebook import” and then the system will return to the main menu.
- If there are no contacts in the phonebook, the voice guide will say “There are no contacts on the connected phone.”

6. When the transfer is complete, the voice guide will say “Import complete” and then the system will return to the main menu.

General information

N00566301106

MODEL: MMC FCC ID: CB2MDGMY10
IC: 279B-MDGMY10

Your Bluetooth® 2.0 interface operates on a radio frequency subject to Federal Communications Commission (FCC) Rules (For vehicles sold in U.S.A.) and Industry Canada Rules (For vehicles sold in Canada). This device complies with Part 15 of the FCC Rules and RSS-210 of the Industry Canada Rules. Operation is subject to the following two conditions:

- This device may not cause harmful interference.
- This device must accept any interference received, including interference that may cause undesired operation.

CAUTION

- Changes or modifications made to this equipment not expressly approved by the manufacturer may void the FCC authorization to operate this equipment.

The term “IC:” before the radio certification number only signifies that Industry Canada technical specifications were met.

The antenna used for this transmitter must not be co-located or operating in conjunction with any other antenna or transmitter. End-users and installers must be provided with installation instructions and transmitter operating conditions for satisfying RF exposure compliance.

FCC Notice: This equipment has been tested and found to comply with the limits for a Class B digital device, pursuant to part 15 of the FCC Rules. These limits are designed to provide reasonable protection against harmful interference in a residential installation.

This equipment generates, uses and can radiate radio frequency energy and, if not installed and used in accordance with the instructions, may cause harmful interference to radio communications.

However, there is no guarantee that interference will not occur in a particular installation. If this equipment does cause harmful interference to radio or television reception, which can be determined by turning the equipment off and on, the user is encouraged to try to correct the interference by one or more of the following measures:

- Reorient or relocate the receiving antenna.
- Increase the separation between the equipment and receiver.

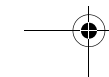
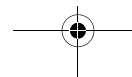

- Connect the equipment into an outlet on a circuit different from that to which the receiver is connected.
- Consult the dealer or an experienced radio/TV technician for help.

ICES Notice: This Class B digital apparatus complies with Canadian ICES-003.

Enrollment commands

N00566401093

Phrase	English	Spanish	French	Japanese
1	123456789	123456789	123456789	123456789
2	888 555 1212	888 555 1212	888 555 1212	888 555 1212
3	Call	Llamar	Appeler	呼び出し
4	Dial	Marcar	Composer	ダイヤル
5	Setup	Configurar	Configurer	設定
6	Cancel	Cancelar	Annuler	キャンセル
7	Continue	Continuar	Continuer	つぎ
8	Help	Ayuda	Aide	ヘルプ

USB input terminal (if so equipped)

N00566701070

You can connect your USB memory device or iPod* to play music files stored in the USB memory device or iPod.

The following explains how to connect and remove a USB memory device or iPod.

*:“iPod” is a registered trademark of Apple Inc. in the United States and other countries.

How to connect a USB memory device

N00566800074

1. Park your vehicle in a safe place and turn the ignition switch to the “LOCK” position.
2. Open the USB input terminal cover (A) in the glove compartment.

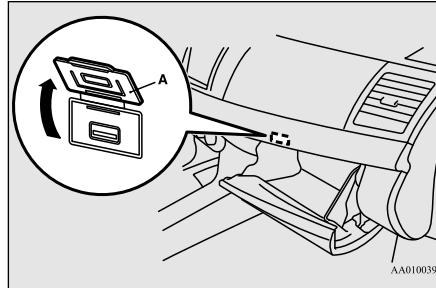

3. Connect a commercially available USB connector cable (C) to the USB memory device (B).

USB input terminal (if so equipped)

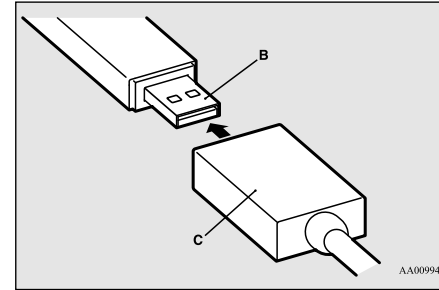

5

4. Connect the USB connector cable (C) to the USB input terminal (D).

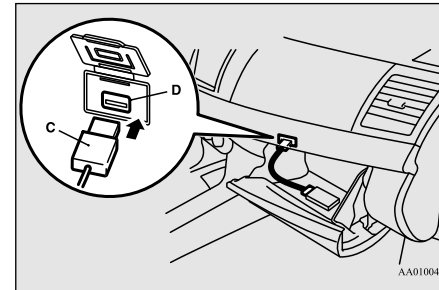

⚠ WARNING

- An open glove compartment door can cause a serious injury or death to the front passenger in an accident, even if the passenger is wearing his/her seat belt. Always keep the glove compartment door closed when driving.

USB input terminal (if so equipped)

NOTE

- Do not connect the USB memory device to the USB input terminal directly. The USB memory device may be damaged.
- When closing the glove compartment, be careful not to trap the USB connector cable.

5

5. To remove the USB connector cable, turn the ignition switch to the “LOCK” position first and perform the installation steps in reverse.

How to connect an iPod

N0056690020

1. Park your vehicle in a safe place and turn the ignition switch to the “LOCK” position.
2. Open the USB input terminal cover (A) in the glove compartment.

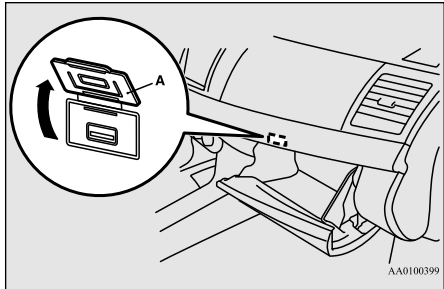

3. Connect the Dock connector (C) to the iPod (B).

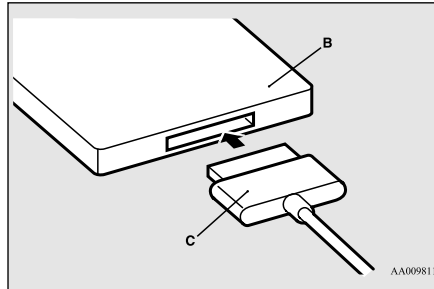

NOTE

- Use a genuine Dock connector from Apple Inc.

4. Connect the Dock connector (C) to the USB input terminal (D).

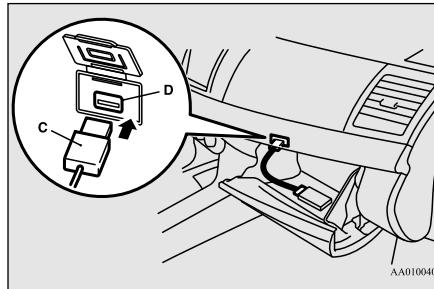

WARNING

- An open glove compartment door can cause a serious injury or death to the front passenger in an accident, even if the passenger is wearing his/her seat belt. Always keep the glove compartment door closed when driving.

NOTE

- When closing the glove compartment, be careful not to trap the connector cable.

5. To remove the Dock connector, turn the ignition switch to the “LOCK” position first and perform the installation steps in reverse.

Types of connectable devices and supported file specifications

N00567001054

Except for vehicles equipped with the Bluetooth® 2.0 interface

N00583200028

For details about the types of connectable devices and supported file specifications, refer to the following pages and manuals.

USB input terminal (if so equipped)

For vehicles equipped with the AM/FM radio/CD player

Refer to “Listen to an iPod” on page 7-47, “Listen to Audio Files on a USB Device” on page 7-49 and “Audio Files (MP3/WMA/AAC)” on page 7-34.

For vehicles equipped with the DISPLAY AUDIO

Refer to the separate owner’s manual.

For vehicles equipped with the Mitsubishi Multi-Communication System

Refer to the separate owner’s manual.

For vehicles equipped with the Bluetooth® 2.0 interface

N00583300029

For details about the types of connectable devices and supported file specifications, refer to the following section.

■ **Device types**

N00583400020

Devices of the following types can be connected.

Model name	Condition
USB memory device	Storage capacity of 256 Mbytes or more
Models other than USB memory devices and iPods	Digital audio player supporting mass storage class

For these connectable device types, “iPod*,” “iPod classic*,” “iPod nano*,” “iPod touch*” and “iPhone*,” refer to the following website:

[For vehicles sold in U.S.A.]

You can access the Mitsubishi Motors North America website.

[For vehicles sold in Canada and Mexico]

You can access the Mitsubishi Motors website. Please read and agree to the “Warning about Links to the Web Sites of Other Companies”. The websites mentioned above may connect you to websites other than the Mitsubishi Motors website.

<http://www.mitsubishi-motors.com/en/products/index.html>

*: “iPod,” “iPod classic,” “iPod nano,” “iPod touch,” and “iPhone” are registered trademarks of Apple Inc. in the United States and other countries.

 **NOTE**

- Depending on the type of the USB memory device or other device connected, the connected device may not function properly or the available functions may be limited.
- It is recommended to use an iPod with firmware updated to the latest version.
- You can charge your iPod by connecting it to the USB input terminal when the ignition switch is in the “ACC” or “ON” position.
- Do not keep your USB memory device or iPod in your vehicle.
- It is recommended that you back up the files in case of data damage.
- Do not connect to the USB input terminal any device (hard disk, card reader, memory reader, etc.) other than the connectable devices specified in the previous section. The device and/or data may be damaged. If any of these devices was connected by mistake, remove it after turning the ignition switch to the “LOCK” position.

5

■ **File specifications**

N00583500021

You can play music files of the following specifications that are saved in a USB memory device or other device supporting mass storage class. When you connect your iPod, playable file specifications depend on the connected iPod.

Sun visors

5

Item	Condition
File format	MP3, WMA, AAC, WAV
Maximum number of levels (including the root)	Level 8
Number of folders	700
Number of files	65,535

Sun visors

N00524600308

Fold the sun visor downward (1) to reduce front glare while driving. To reduce side glare, turn the visor to the side (2).

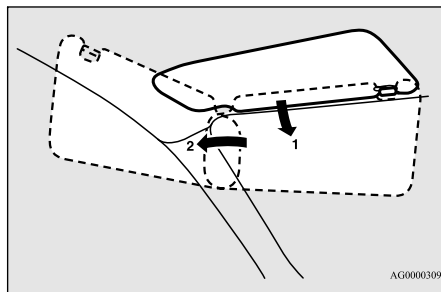

Vanity mirror

The vanity mirrors are located on the back of the sun visors.

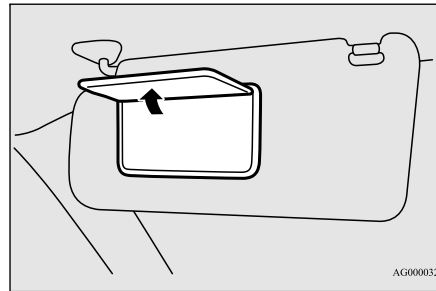

Card holder

Cards can be slipped into the front (A) of the lid of the vanity mirror.

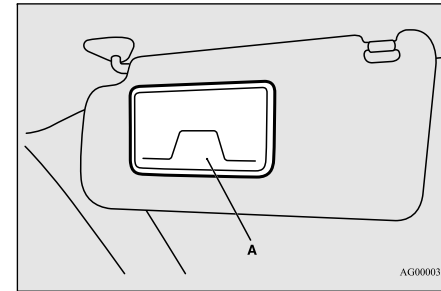

12 V power outlet

N00525000556

⚠ CAUTION

- Be aware that using electronic equipment with the engine off may run the battery down.
- When the 12 V power outlet is not in use, be sure to put on the plug or close the 12 V power outlet cover. This will prevent the 12 V power outlet from becoming dirty and possibly short-circuiting.

12 V power outlets are located in front of the floor console (Type 1, Type 2) and inside of the floor console box (Type 3).

NOTE

- If your vehicle is equipped with two 12 V power outlets, both power outlets can be used simultaneously.

CAUTION

- Be sure to use a “plug-in” type accessory operating at 12 V and 120 W or less. When using two 12 V power outlets or 12 V power outlet and cigarette lighter simultaneously, make sure that the total power consumption of these does not exceed 120 W at 12 V.

Type 1, Type 2

The accessory can be operated when the ignition switch is in the “ON” or “ACC” position. To use a “plug-in” type accessory, pull out the plug, then insert the plug in the socket.

Type 1



Type 2

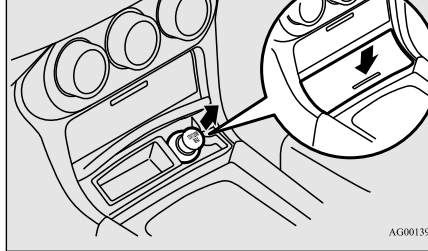

Type 3 (if so equipped)

The accessory can be operated when the ignition switch is in any position. To use a “plug-in” type accessory, open the cover, then insert the plug in the socket.

Interior lights

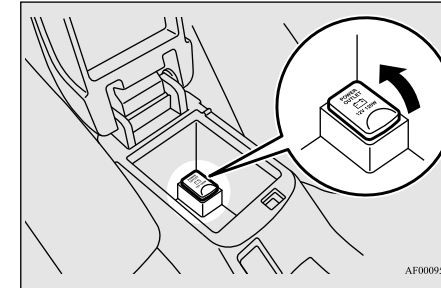

5

Interior lights

N00525300461

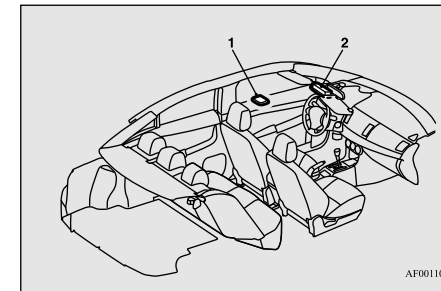

- 1- Dome light (Rear) (if so equipped) →P.5-186
- 2- Dome light (Front)/Reading lights (if so equipped) →P.5-186

Interior lights

Dome light (Front)/Reading lights (if so equipped)

N00525801261

Dome light (Front)

5

The dome light can be turned on by sliding the dome light switch.

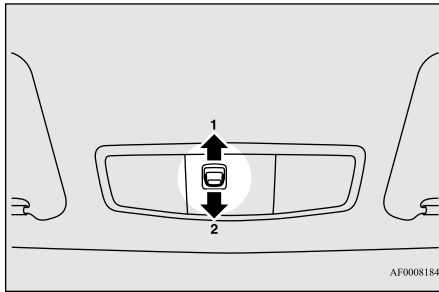

1- (DOOR)

The dome light comes on when any door is opened. When all the doors are closed, the dome light illuminates for about 30 seconds then goes off. However, the light goes off immediately if:

- The door is closed while the ignition switch is in the “ON” position.

- The driver’s door is closed after all the other doors are closed while the lock knob of the driver’s door is in the lock position.
- The door is closed and the power door lock switch is used to lock the doors.
- In vehicles equipped with the keyless entry system, the keyless entry system remote control transmitter is used to lock the doors.
- In vehicles equipped with the F.A.S.T.-key, the doors are locked using the F.A.S.T.-key.

NOTE

- When the engine is started using the key while the doors are closed, if you remove the key, the dome light will illuminate for about 30 seconds before going off.
- When the engine is started using the F.A.S.T.-key while the doors are closed, if the ignition switch is moved to the “LOCK” position, the dome light will illuminate for about 30 seconds before going off.
- The time until the light goes off can be adjusted. See your authorized Mitsubishi Motors dealer for details.

2- (OFF)

The dome light goes off.

Reading lights

N00553800067

Regardless of the dome light switch position, when you press the lens, the light on the side that is pressed illuminates; when you press the lens again, the light goes off.

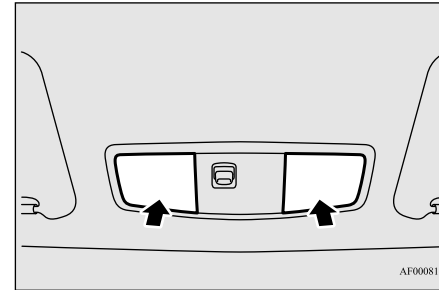

Dome light (Rear) (if so equipped)

N00525401485

The dome light can be turned on by sliding the dome light switch.

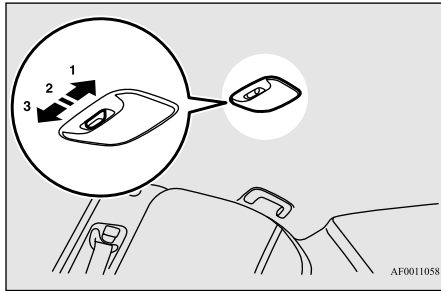

- 1- (ON)
The dome light comes on.
- 2- (●)
The dome light comes on when any door is opened. When all the doors are closed, the dome light illuminates for about 30 seconds then goes off. However, the light goes off immediately if:
- The door is closed while the ignition switch is in the “ON” position.
 - The driver’s door is closed after all the other doors are closed while the lock knob of the driver’s door is in the lock position.
 - The door is closed and the power door lock switch is used to lock the doors.
 - In vehicles equipped with the keyless entry system, the keyless entry system remote control transmitter is used to lock the doors.

- In vehicles equipped with the F.A.S.T.-key, the doors are locked using the F.A.S.T.-key.

NOTE

- When the engine is started using the key while the doors are closed, if you remove the key, the dome light will illuminate for about 30 seconds before going off.
- When the engine is started using the F.A.S.T.-key while the doors are closed, if the ignition switch is moved to the “LOCK” position, the dome light will illuminate for about 30 seconds before going off.
- The time until the light goes off can be adjusted. See your authorized Mitsubishi Motors dealer for details.

- 3- (OFF)
The dome light goes off.

Interior light auto-cutout function (dome light and other lights)

N00526301465

If any of the interior lights are left on with the ignition switch in the “LOCK” position, the lights go off automatically after about 30 minutes.

Storage spaces

The lights come on again if the ignition switch is turned to the “ON” or “ACC” position, any door or the trunk lid is opened and closed, or the keyless entry system or F.A.S.T.-key is operated.

NOTE

- The interior light auto-cutout function can be deactivated. The time until the lights automatically go off can be adjusted. See your authorized Mitsubishi Motors dealer for details.

5

Storage spaces

N00526400485

CAUTION

- Never leave lighters, carbonated drink cans, or spectacles in the cabin when parking the vehicle in hot sunshine. The cabin will become extremely hot, so lighters and other flammable items may catch fire and unopened drink cans (including beer cans) may rupture. The heat may also deform or crack plastic spectacle parts.
- Keep the lids of storage spaces closed while driving the vehicle. A lid or the contents of a storage space could otherwise cause injuries during a sudden stop.

Storage spaces

NOTE

- Do not leave valuables in any storage space when leaving the vehicle.

[Except for RALLIART]

5

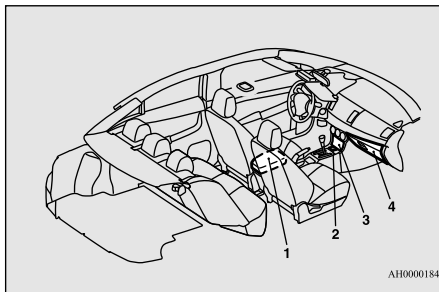

- 1- Floor console box (if so equipped) →P.5-189
- 2- Front console tray (if so equipped) →P.5-189
- 3- Front console boxes (if so equipped) →P.5-189
- 4- Glove compartment →P.5-188

[RALLIART]

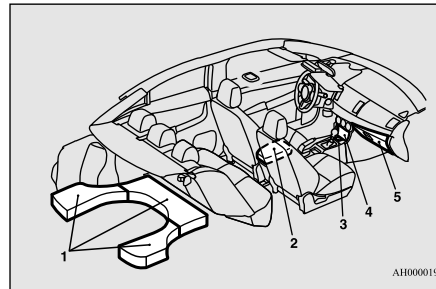

- 1- Luggage floor boxes →P.5-190
- 2- Floor console box →P.5-189
- 3- Front console tray (if so equipped) →P.5-189
- 4- Front console boxes (if so equipped) →P.5-189
- 5- Glove compartment →P.5-188

Glove compartment

N00551500246

To open the glove compartment, pull the lever (A).

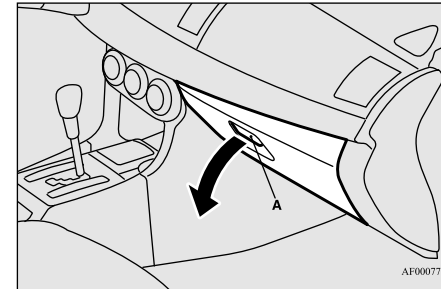

WARNING

- An open glove compartment door can cause a serious injury or death to the front passenger in an accident, even if the passenger is wearing his/her seat belt. Always keep the glove compartment door closed when driving.

NOTE

- The USB input terminal (if so equipped) is located in the glove compartment. For details, refer to “USB input terminal” on page 5-181.

Card holder

There is a card holder on the inside of the glove compartment.

Storage spaces

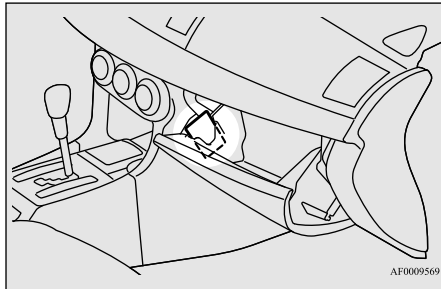

CAUTION

- Do not use the front console tray as an ash-tray. This could cause a fire.

Front console boxes (if so equipped)

N00546401071

To open, push the lid.

Upper box

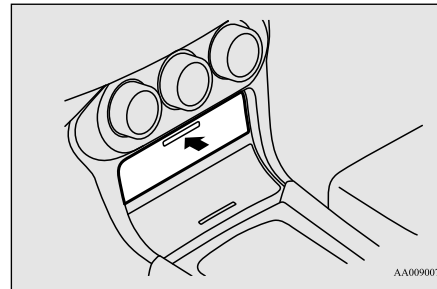

NOTE

- Up to 2 cards will fit in the card holder.

Front console tray (if so equipped)

N00547800017

The front console tray is on the front console part.

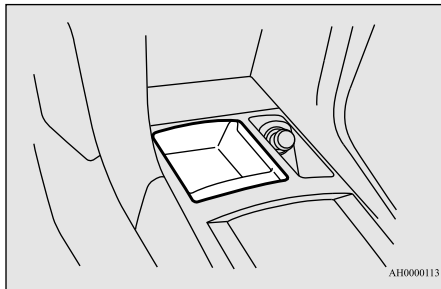

Lower box

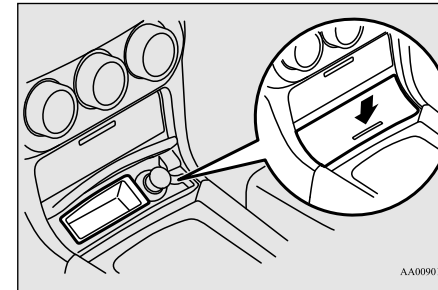

5

CAUTION

- Do not use the front console boxes as an ash-tray. This could cause a fire.

Floor console box with lid (if so equipped)

N00551600188

To open the floor console box, lift the release lever (A) and raise the lid.

Cup holder

5

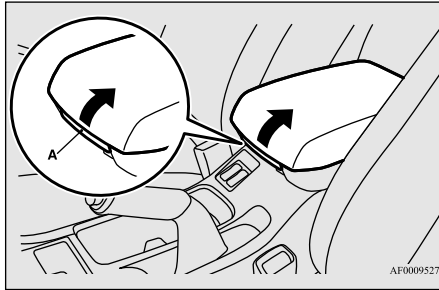

Luggage floor boxes (if so equipped)

N00552400066

The boxes for storing articles are located inside the luggage compartment. To use the boxes, remove the floor mat (A) and raise the lids (B).

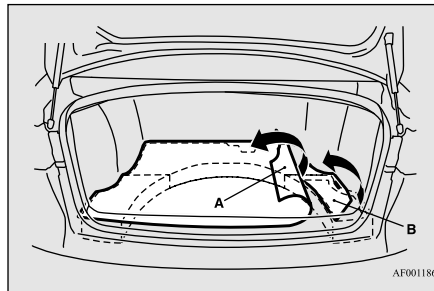

Tissue holder

The tissue holder (A) is located on the underside of the floor console box lid.

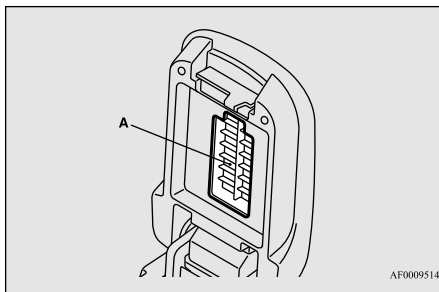

Cup holder

N00527300351

For the front seat

The cup holder is located the middle of the floor console. The cup holder is designed for holding cups or drink-cans securely.

Type 1

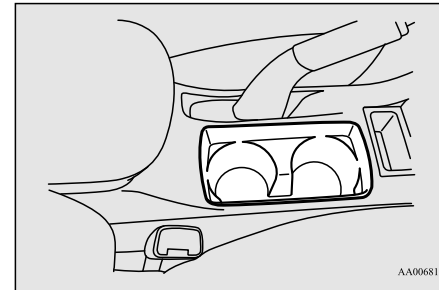

AA0068132

Type 2

To use the cup holder, open up the lid.

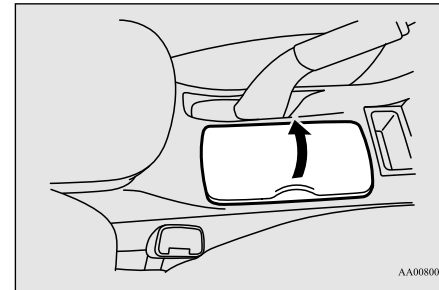

AA0080073

⚠ CAUTION

- Do not drink beverages while driving your vehicle. This is distracting and could cause an accident.

For the rear seat (if so equipped)

N00537000159

This cup holder is located in the rear seat arm rest (A). Pull the rear arm rest down to use the cup holder.

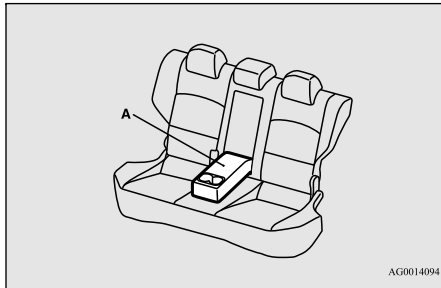

Bottle holder

N00502800049

⚠ CAUTION

- Do not drink beverages while driving your vehicle. This is distracting and could cause an accident.
- Vibration and shaking while driving may cause beverages to spill. Be very careful, as spilling hot beverages could cause burns.

📖 NOTE

- Make sure all lids are tightly closed when storing beverages that are in plastic bottles, etc.
- Some beverages may not be stored, depending on the size and shape of the plastic bottles, etc.

There are bottle holders located on both sides of the front seats.

Bottle holder

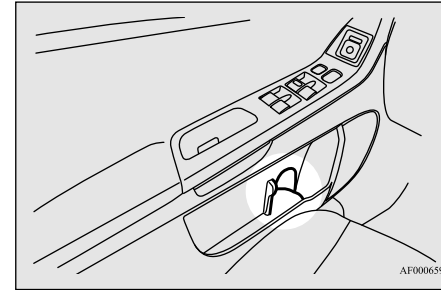

5

Assist grip

N00559000029

These grips are to support the body by hand while seated in the vehicle.

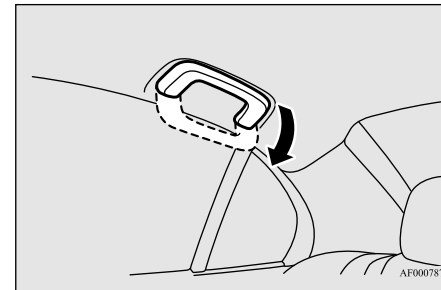

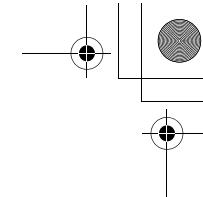

Coat hook (if so equipped)

CAUTION

- Do not use the assist grips when getting into or out of the vehicle. The assist grips could detach and cause an accident.

WARNING

- Do not put a hanger or any heavy or pointed object on the coat hook. If the curtain airbag was activated, any such item could be propelled away with great force and could prevent the curtain airbag from inflating correctly. Hang clothes directly on the coat hook (without using a hanger). Make sure there are no heavy or sharp objects in the pockets of clothes that you hang on the coat hook.

5 Coat hook (if so equipped)

N00553600108

There is a coat hook on the rear seat assist grip of the driver's side.

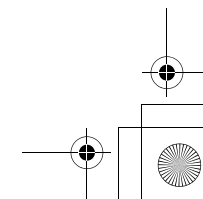
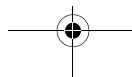
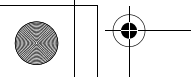
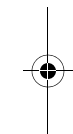
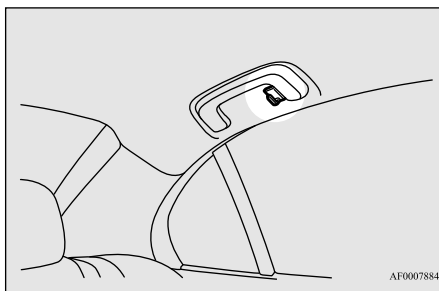
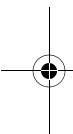

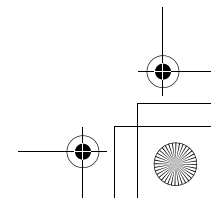
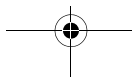
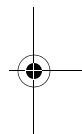
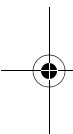
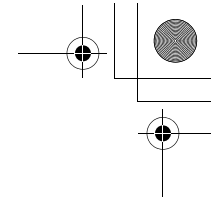

Multiple horizontal dashed lines for writing or printing.

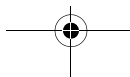
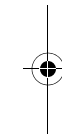
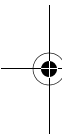

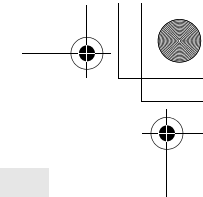

Driving safety

Fuel economy	6-2
Driving, alcohol and drugs	6-2
Floor mat	6-2
Vehicle preparation before driving	6-3
Safe driving techniques	6-4
Driving during cold weather	6-4
Braking	6-5
Parking	6-6
Loading information	6-6
Cargo loads	6-10
Trailer towing	6-11

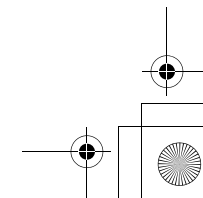
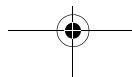
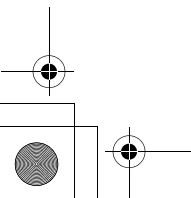
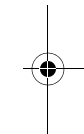
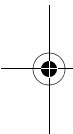

Fuel economy

Fuel economy

N00628800165

Fuel economy is dependent on many factors. Your personal driving habits can have a significant effect on your fuel use. Several recommendations for achieving the greatest fuel economy are listed below.

6

- Whenever accelerating from a stop, always accelerate slowly and smoothly.
- When parked for even a short period, do not idle the engine. Shut it off.
- Plan your trips to avoid unnecessary stops.
- Keep your tires inflated to the recommended pressures.
- When you drive on highways or dry improved roads, set the drive mode-selector “2WD” or “4WD AUTO” position (if so equipped).
- For freeway driving, maintain a speed of approximately 50 mph (80 km/h) when traffic, roadway and weather conditions safely permit.
- Keep your air filter clean and your vehicle lubricated according to the recommendations in this manual.
- Always keep your vehicle well maintained. A poorly maintained engine wastes fuel and costs money.
- Do not overload your vehicle.

Driving, alcohol and drugs

N00628900052

Drunk driving is one of the most frequent causes of accidents.

Your driving ability can be seriously impaired even with blood alcohol levels far below the legal minimum. If you have been drinking, don't drive. Ride with a designated non-drinking driver, call a cab or a friend, or use public transportation. Drinking coffee or taking a cold shower will not make you sober. Similarly, prescription and nonprescription drugs affect your alertness, perception and reaction time. Consult with your doctor or pharmacist before driving while under the influence of any of these medications.

WARNING

- **NEVER DRINK AND DRIVE.**
Your perceptions are less accurate, your reflexes are slower and your judgment is impaired.

Floor mat

N00628600017

The original equipment floor mat provided with your vehicle was specifically designed for your vehicle. Always properly position the floor mat and assure it does not interfere with operation of the pedals. Always use the

retaining clip on the driver's floorboard to secure the floor mat. When used, this clip will help prevent the floor mat from moving forward and possibly interfering with the operation of the pedals. To prevent the floor mat from moving forward and possibly interfering with the operation of the pedals, Mitsubishi genuine floor mats are recommended.

To install the floor mat

N00628700050

1. Place the floor mat to fit the shape of the floorboard.
2. Align the floor mat with the installation holes over the retaining clips.
3. Secure the floor mat with retaining clips.

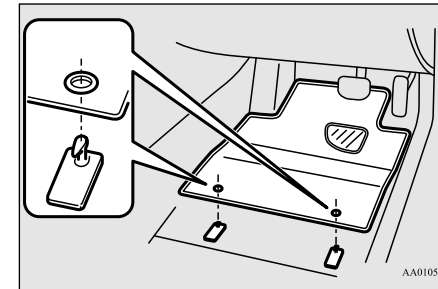

NOTE

- The shape of the mat and the number of retaining clips may vary depending on the vehicle model.

⚠ WARNING

- If a floor mat is the wrong size or is not properly installed, it can interfere with the operation of the pedals. Interference with the pedals can cause unintended acceleration and/or increased stopping distances resulting in a crash and injury. Always make sure the floor mat does not interfere with the accelerator or brake pedal.
- Always use the retaining clip on the driver's floorboard to secure the floor mat.
- Always install the mat with the correct side facing down.
- Never install a second mat over or under an existing floor mat.
- Do not use a floor mat designed for another model vehicle even if it is a Mitsubishi genuine floor mat.
- Before driving, be sure to check the following:
 - Periodically check that the floor mat is properly secured with the retaining clips. If you remove the floor mat while cleaning the inside of your vehicle or for any other reason, always check the condition of the floor mat after it has been reinstalled.
 - While the vehicle is stopped with the engine off, check that the floor mat is not interfering with the pedals by depressing the pedals fully.

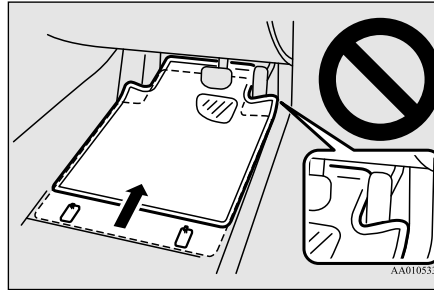

Vehicle preparation before driving

N00629000337

For a safer and more enjoyable trip, always observe the following:

Seat belts and seats

- Before starting the vehicle, make certain that you and all passengers are seated and wearing their seat belts properly (with children in the rear seat, in appropriate restraints), and that all the doors are locked.

Vehicle preparation before driving

- Move the driver's seat as far backward as possible, while still keeping good visibility, and good control of the steering wheel, brakes, accelerator, and controls. Check the instrument panel indicators and multi-information display for any possible problem.
- Move the front passenger seat as far back as possible.
- Make sure that infants and small children are properly restrained in accordance with all laws and regulations.

6

Defrosters

Check these by selecting the defroster mode, and set the blower switch on high. You should be able to feel the air blowing against the windshield.

(Refer to "Defrosting or defogging the windshield and door windows" on page 7-6, 7-12, 7-17, 7-22, 7-27.)

Tires

Check all the tires for heavy tread wear or uneven wear patterns. Look for stones, nails, glass, or other objects stuck in the tread. Look for any tread cuts or sidewall cracks. Check the wheel nuts for tightness, and the tires (including spare tire) for proper pressures.

Driving safety 6-3



Safe driving techniques

Replace your tires before they are heavily worn out.

As your vehicle is equipped with a tire pressure monitoring system, there is a risk of damage to the tire inflation pressure sensors when the tire is replaced on the rim. Tire replacement should, therefore, be performed only by an authorized Mitsubishi Motors dealer.

6

Lights

Have someone watch while you turn all the exterior lights on and off. Also check the turn signal indicators and high-beam indicators on the instrument panel.

Fluid leaks

Check the ground under the vehicle after parking overnight, for fuel, water, oil, or other leaks. Make sure all the fluid levels are correct. Also, if you can smell fuel, you need to find out why immediately and have it fixed.

Safe driving techniques

N00629200111

Even this vehicle's safety equipment, and your safest driving, cannot guarantee that you

6-4 Driving safety



can avoid an accident or injury. However, if you give extra attention to the following areas, you can better protect yourself and your passengers:

- Drive defensively. Be aware of traffic, road and weather conditions. Leave plenty of stopping distance between your vehicle and the vehicle ahead.
- Before changing lanes, check your mirrors and use your turn signal light.
- While driving, watch the behavior of other drivers, bicyclists, and pedestrians.
- Always obey applicable laws and regulations. Be a polite and alert driver. Always leave room for unexpected events, such as sudden braking.
- If you plan to drive in another country, obey their vehicle registration laws and make sure you will be able to get the right fuel.

Driving during cold weather

N00629400429

- Check the battery, including terminals and cables. During extremely cold weather, the battery will not be as strong. Also, the battery power level may drop because more power is used for cold starting and driving.

Before driving the vehicle, check to see if the engine runs at the proper speed and if the headlights are as bright as normally. Charge or replace the battery if necessary. During extreme cold weather, it is possible that a very low battery could freeze.

WARNING

- **The battery gives off explosive hydrogen gas. Any spark or flame can cause the battery to explode, which could cause serious injury or death.**
Always wear protective clothes and a face mask when working with your battery, or let a skilled mechanic do it.

- Warm the engine sufficiently. After starting the engine, allow a short warm-up time to distribute oil to all cylinders and turbocharger. Then drive your vehicle slowly.
- Stay at low speeds at first so that the transaxle, transfer case and rear axle oil have time to spread to all the lubrication points.
- Manual transaxle can be harder to shift in cold weather conditions. This is normal and shifting will get easier as the transaxle warms up.
- Check the engine antifreeze.

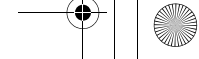
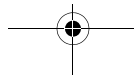
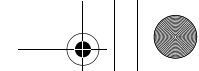

Braking

If there is not enough coolant because of a leak or from engine overheating, add Mitsubishi Motors Genuine Super Long Life Coolant Premium or equivalent.

Please read this section in conjunction with the “Engine coolant” on page 9-8.

WARNING

- Never open the radiator cap when the radiator is hot. You could be seriously burned.

[For RALLIART vehicles sold in U.S.A.]

- Mitsubishi Motors recommends that the standard equipment tires be replaced with winter tires when the vehicle is going to be used in winter.

The standard equipment tires provided with this vehicle are summer tires and use a high-grip compound that provides superior grip.

The road grip, however, is reduced in winter.

When replacing the standard equipment tires with winter tires, all four tires must be replaced using radial identicalsize winter tires.

NOTE

- As your vehicle is equipped with a tire pressure monitoring system, there is a risk of damage to the tire inflation pressure sensors when the tire is replaced on the rim. Tire replacement should, therefore, be performed only by an authorized Mitsubishi Motors dealer.
- If you use new wheels with new tire inflation pressure sensors, their ID codes must be programmed into the tire pressure monitoring system. Refer to “Whenever the tires and wheels are replaced with new ones” on page 5-105.

Braking

N00629500446

All the parts of the brake system are critical to safety. Have the vehicle serviced by an authorized Mitsubishi Motors dealer or a repair facility of your choice at regular intervals according to the “WARRANTY AND MAINTENANCE MANUAL”.

When brakes are wet

Check the brake system while driving at a low speed immediately after starting, especially when the brakes are wet, to confirm they work normally.

A film of water can be formed on the brake discs or brake drums and prevent normal braking after driving in heavy rain or through large puddles, or after the vehicle is washed. If this occurs, dry the brakes out by driving slowly while lightly depressing the brake pedal.

When driving in cold weather

6

On snowy roads, ice can form on the braking system, making the brakes less effective. While driving in such conditions, pay close attention to preceding and following vehicles and to the condition of the road surface. From time to time, lightly depress the brake pedal and check how effective the brakes are.

When driving downhill

It is important to take advantage of the engine braking by shifting to a lower gear while driving on steep downhill roads in order to prevent the brakes from overheating.

Parking

Parking

N00629600287

Parking on a hill

When parking on a hill, set the parking brake, and turn the front wheels toward the curb on a downhill, or away from the curb on an uphill.

6

For vehicles with manual trans- axle

Place the gearshift lever into the “R” (Reverse) position when parking on a downhill slope, into the 1st position when parking on an uphill slope.

For vehicles with continuously variable transmission (CVT) or Twin Clutch SST

Be sure that the parking brake is firmly set when parked and that the selector lever (CVT) or gearshift lever (Twin Clutch SST) is in the “P” (PARK) position.

When parking on a hill, it is important to set the parking brake before moving the selector lever (CVT) or gearshift lever (Twin Clutch

SST) to the “P” (PARK) position. This prevents loading the parking brake against the transaxle gear. When this happens, it is difficult to move the selector lever (CVT) or gearshift lever (Twin Clutch SST) out of the “P” (PARK) position.

Parking with the engine run- ning

Never leave the engine running while you take a short sleep/rest. Also, never leave the engine running in a closed or poorly ventilated place.

WARNING

- Leaving the engine running risks injury or death from accidentally moving the gearshift lever (manual transaxle or Twin Clutch SST) or the selector lever (CVT) or from the accumulation of toxic exhaust fumes in the passenger compartment.

Where you park

Your front bumper can be damaged if you scrape it over curbs or parking stop blocks. Be careful when traveling up or down steep slopes where your bumper can scrape the road.

WARNING

- Do not park your vehicle in areas where combustible materials such as dry grass or leaves can come in contact with a hot exhaust, since a fire could occur.

When leaving the vehicle

When leaving the vehicle unattended, always carry the key and lock all doors. Always try to park your vehicle in a well lit area.

Loading information

N00629900349

It is very important to know how much weight your vehicle can carry. This weight is called the vehicle capacity weight and includes the weight of all occupants, cargo and non-factory-installed options. The tire and loading information placard located on the driver’s door sill of your vehicle will show how much weight it may properly carry.

WARNING

- Never overload your vehicle. Overloading can damage your vehicle, adversely affect vehicle performance, including handling and braking, cause tire failure, and result in an accident.

It is important to familiarize yourself with the following terms before loading your vehicle:

- Vehicle maximum load on the tire: load on an individual tire that is determined by distributing to each axle its share of the maximum loaded vehicle weight and dividing by two.
- Vehicle normal load on the tire: load on an individual tire that is determined by distributing to each axle its share of the curb weight, accessory weight, and normal occupant weight and dividing by two.
- Maximum loaded vehicle weight: the sum of -
 - (a) Curb weight;
 - (b) Accessory weight;
 - (c) Vehicle capacity weight; and
 - (d) Production options weight.
- Curb weight: the weight of a motor vehicle with standard equipment including the maximum capacity of fuel, oil, and coolant.
- Accessory weight: the combined weight (in excess of those standard items which may be replaced) of automatic transmission, power steering, power brakes, power windows, power seats, radio, and heater, to the extent that these items are available as factory-installed equipment (whether installed or not).

- Vehicle capacity weight: the rated cargo and luggage load plus 150 lbs (68 kg)* times the vehicle's designated seating capacity.
- Production options weight: the combined weight of those installed regular production options weighing over 5 lbs (2.3 kg) in excess of those standard items which they replace, not previously considered in curb weight or accessory weight, including heavy duty brakes, ride levelers, roof rack, heavy duty battery, and special trim.
- Normal occupant weight: 150 lbs (68 kg)* times the number of specified occupants. (In your vehicle the number is 3)
- Occupant distribution: distribution of occupants in a vehicle as specified. (In your vehicle the distribution is 2 in front, 1 in second row seat)

*:150 lbs (68 kg) is the weight of one person as defined by U.S.A. and Canadian regulations.

Tire and loading information placard

N00630100309

The tire and loading information placard is located on the driver's door sill.

Loading information

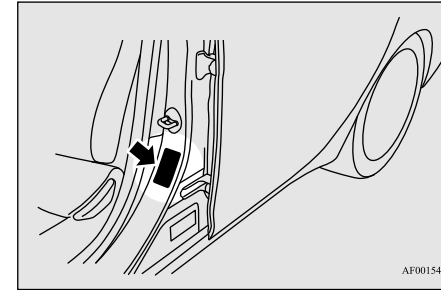

6

This placard shows the maximum number of occupants permitted to ride in your vehicle as well as “the combined weight of occupants and cargo” (A), which is called the vehicle capacity weight. The weight of roof load is included in the definition of “cargo” when determining the vehicle capacity weight. This placard also tells you the size and recommended inflation pressure for the original equipment tires on your vehicle. For more information, refer to “Tires” on page 9-17.

Loading information

Type 1

6

EXAMPLE

TIRE AND LOADING INFORMATION

SEATING CAPACITY TOTAL FRONT REAR

The combined weight of occupants and cargo should never exceed kg or lbs.

TIRE	SIZE	COLD TIRE PRESSURE		SEE OWNER'S MANUAL FOR ADDITIONAL INFORMATION
FRONT		<input type="text"/> kPa	<input type="text"/> PSI	
REAR		<input type="text"/> kPa	<input type="text"/> PSI	
SPARE		<input type="text"/> kPa	<input type="text"/> PSI	

PART NO.

AG0018395

Type 2

EXAMPLE

TIRE AND LOADING INFORMATION
RENSEIGNEMENTS SUR LES PNEUS ET LE CHARGEMENT

SEATING CAPACITY TOTAL FRONT REAR
(NOMBRE DE PLACES AVANT ARRIERE)

The combined weight of occupants and cargo should never exceed kg or lbs.
Le poids total des occupants et du chargement ne doit jamais dépasser kg ou lbs.

TIRE PNEU	SIZE DIMENSIONS	COLD TIRE PRESSURE PRESSION DES PNEUS A FROID		SEE OWNER'S MANUAL FOR ADDITIONAL INFORMATION VOIR LE MANUEL DU PROPRIETAIRE POUR PLUS DE RENSEIGNEMENTS
FRONT AVANT		<input type="text"/> kPa	<input type="text"/> psi	
REAR ARRIERE		<input type="text"/> kPa	<input type="text"/> psi	
SPARE DE SECOURS		<input type="text"/> kPa	<input type="text"/> psi	

PART NO.

AF0015463

Steps for Determining Correct Load Limit

N00630201235

1. Locate the statement “The combined weight of occupants and cargo should never exceed XXX kg or XXX lbs.” on your vehicle’s placard.
2. Determine the combined weight of the driver and passengers that will be riding in your vehicle.
3. Subtract the combined weight of the driver and passengers from XXX kg or XXX lbs.
4. The resulting figure equals the available amount of cargo and luggage load capacity. For example, if the “XXX” amount equals 1400 lbs. and there will be five 150 lbs. passengers in your vehicle, the amount of available cargo and luggage load capacity is 650 lbs. (1400 - 750 (5 x 150) =650 lbs.)

5. Determine the combined weight of luggage and cargo being loaded on the vehicle. That weight may not safely exceed the available cargo and luggage load capacity calculated in Step 4.
6. If your vehicle will be towing a trailer, load from your trailer will be transferred to your vehicle. Consult this manual to determine how this reduces the available cargo and luggage load capacity of your vehicle.

NOTE

- The above steps for determining correct load limit were written in accordance with U.S.A. regulations. Your vehicle cannot tow a trailer, so step 6 is irrelevant.

NOTE

- The following table shows examples on how to calculate total cargo/load capacity of your vehicle with varying seating configurations and number and size of occupants. This table is for illustration purposes only and may not be accurate for the seating and load capacity of your vehicle.
- For the following example the combined weight of occupants and cargo should never exceed 865 lbs (392 kg).

Occupants			Combined weight of occupants and cargo from Tire Placard	MINUS	Combined Occupant's weight	=	AVAILABLE Cargo/Luggage Weight
TOTAL	FRONT	REAR					
EXAMPLE 1							
5	2	3	865 lbs (392 kg)	minus	Occupant 1: 200 lbs (91 kg) Occupant 2: 130 lbs (59 kg) Occupant 3: 160 lbs (73 kg) Occupant 4: 100 lbs (45 kg) Occupant 5: 80 lbs (36 kg)	=	195 lbs (88 kg)
EXAMPLE 2							
3	2	1	865 lbs (392 kg)	minus	Occupant 1: 210 lbs (95 kg) Occupant 2: 180 lbs (82 kg) Occupant 3: 150 lbs (68 kg)	=	325 lbs (147 kg)
EXAMPLE 3							
2	2	0	865 lbs (392 kg)	minus	Occupant 1: 200 lbs (91 kg) Occupant 2: 200 lbs (91 kg)	=	465 lbs (210 kg)

AHM100188

- Under a maximum loaded vehicle condition, gross axle weight ratings (GAWR's) for the front and rear axles must not be exceeded. For further information on GAWR's, vehicle loading, see the "Specifications" section of this manual.

Cargo loads

Cargo loads

N00629700464

Cargo load precautions

To determine the cargo load capacity for your vehicle, subtract the weight of all vehicle occupants from the vehicle capacity weight.

6

For added information, if needed, refer to “Steps for Determining Correct Load Limit” on page 6-8.

DO NOT USE the Gross Vehicle Weight Rating and Gross Axle Weight Rating numbers listed on the safety certification label (A) located on the inside sill of the driver’s door as the guide for passengers and/or cargo weight.

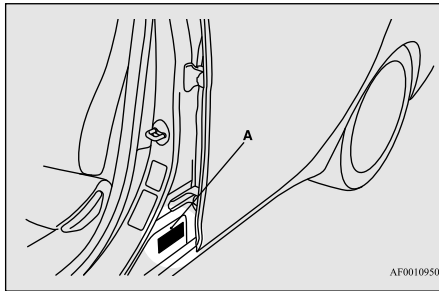

AF0010950

⚠ WARNING

- To reduce the risk of serious injury or death, the combined weights of the driver, passengers and cargo and must never exceed the vehicle capacity weight.
- Exceeding the vehicle capacity weight will adversely affect vehicle performance, including handling and braking, and may cause an accident.
- Do not load cargo or luggage higher than the top of the seatback. Be sure that your cargo or luggage cannot move when your vehicle is in motion.
Having either the rear view blocked, or your cargo being thrown inside the cabin if you suddenly have to brake can cause a serious accident or injury or death.
- Put cargo or luggage in the cargo area of your vehicle. Try to spread the weight evenly.

Loading cargo on the roof

N00630400113

⚠ WARNING

- Weight placed on the roof of the vehicle will raise the vehicle’s center of gravity and adversely affect its handling characteristics. As a result, driving errors or emergency maneuvers could lead to a loss of control and result in an accident. Drive slowly and avoid excessive maneuvers such as sudden braking or quick turning.

⚠ WARNING

- Make sure that the weight of luggage and the roof carrier do not exceed the maximum roof load, 110 lb (50 kg). If the maximum roof load is exceeded, this could cause damage to the vehicle or result in an accident.
- The total weight of all occupants and luggage, including your roof load, must not exceed the vehicle capacity weight. For more information, refer to “Tire and loading information placard” on page 11-3.
- Roof load is determined by adding the weight of the roof carrier and the weight of the luggage placed on the roof carrier.
- For additional information, refer to “Maximum roof load” on page 11-4.

⚠ CAUTION

- Do not load luggage directly onto the roof. Use a roof carrier that properly fits your vehicle.
For installation, refer to the instruction manual provided with the roof carrier.
- Place the luggage on the carrier so that its weight is distributed evenly with the heaviest items on the bottom. Do not load items that are wider than the roof carrier.

Trailer towing

⚠ CAUTION

- Before driving and after traveling a short distance, always check the load to make sure it is securely fastened to the roof carrier. Stop the vehicle periodically and check that the load remains secure. If the load is not secure, it could fall from the vehicle and damage your vehicle, another vehicle or create a road hazard.

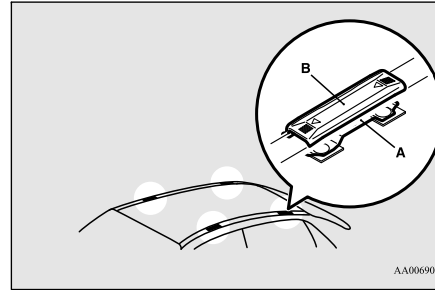

📖 NOTE

- To prevent wind noise or reduction in gas mileage, remove the roof carrier when not in use.
- Before using an automatic car wash, check with the attendant to determine if the roof carrier should be removed.
- Be sure that adequate clearance is maintained for raising the sunroof when installing a roof carrier. (For vehicle with sunroof only)

Attaching the roof carrier

Slide each cover (B) toward the front of the vehicle to remove it.

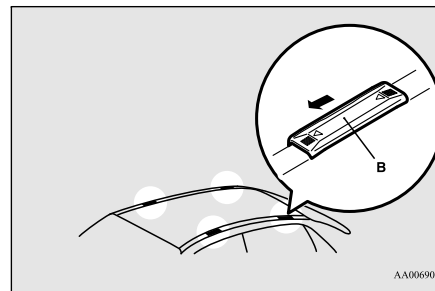

Roof carrier mounting brackets (if so equipped)

N00630600102

When installing the roof carrier, use the brackets (A). The brackets (A) are located under each cover (B).

Refitting the covers

1. With each cover, put the tabs (C) on the cover in the holes (D) in the roof.
2. Slide the cover (B) toward the rear of the vehicle to install it.

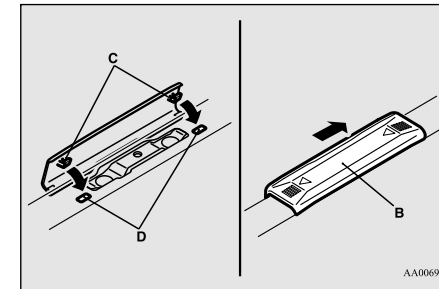

6

Trailer towing

N00629801332

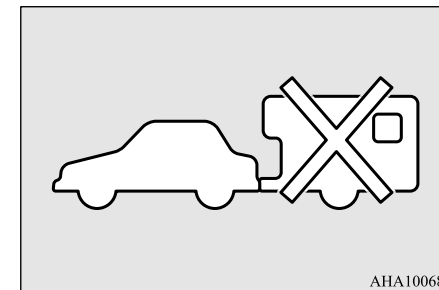

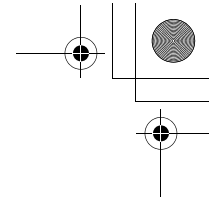
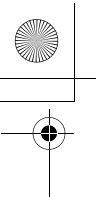

Trailer towing

⚠ WARNING

- Do not use this vehicle for trailer towing. It may not be possible to maintain control or adequate braking.

6

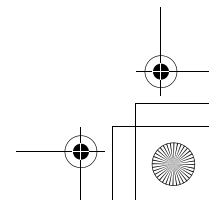
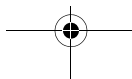
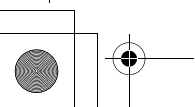
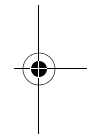
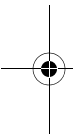

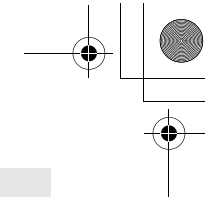

Comfort controls

Vents	7-2	Clock (if so equipped)	7-64
Heater without air conditioning function (if so equipped)	7-4	General information about your radio	7-65
Manual air conditioning with MAX A/C mode (if so equipped)	7-7		
Manual air conditioning without MAX A/C mode (if so equipped)	7-12		
Automatic air conditioning with Fahrenheit scale (if so equipped)	7-17		
Automatic air conditioning with Celsius scale (if so equipped)	7-22		
Important air conditioning operating tips	7-28		
Air purifier	7-28		
AM/FM radio/CD player (if so equipped)	7-29		
Handling of Discs	7-32		
Audio Files (MP3/WMA/AAC)	7-34		
Important Points on Safety for the Customer	7-38		
Operation Keys	7-38		
Listen to Radio	7-42		
Listen to Satellite Radio (if so equipped)	7-43		
Listen to CDs	7-45		
Listen to MP3s	7-46		
Listen to an iPod	7-47		
Listen to Audio Files on a USB Device	7-49		
Listen to Bluetooth Audio (if so equipped)	7-52		
Use AUX (if so equipped)	7-53		
Display Indicator	7-55		
Audio Quality and Volume Balance Adjustment	7-56		
System Settings	7-57		
Troubleshooting	7-61		
Antenna	7-63		

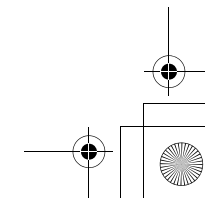
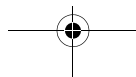
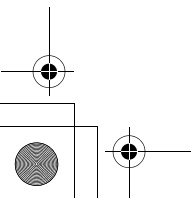
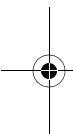

Vents

Vents

N00729900210

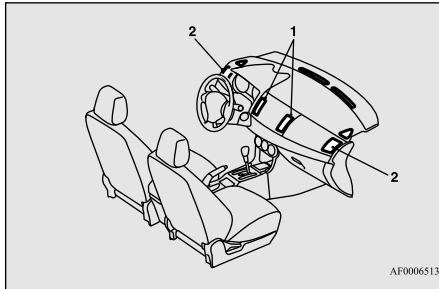

AF0006513

7

- 1- Center vents
- 2- Side vents

Air flow and direction adjustments

N00730200301

Center vents

Move the knob to make adjustments.
To close the vent, move the knob to the inside as far as possible.

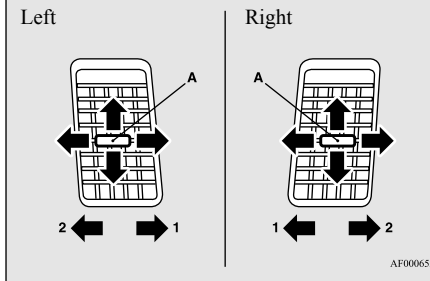

AF0006526

- A- Knob
- 1- Close
- 2- Open

Side vents

Move the knob to make adjustments.
To close the vent, move the knob to the outside as far as possible.

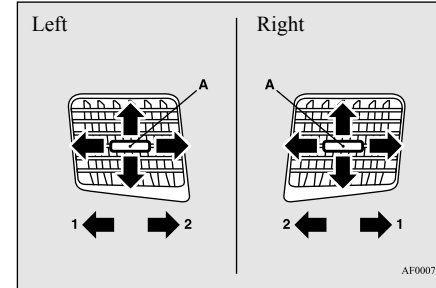

AF0007985

- A- Knob
- 1- Close
- 2- Open

NOTE

- On rare occasions, air from the vents of an air-conditioned vehicle may be foggy. This is only moist air cooling suddenly and does not indicate a problem.
- Do not let drinks or other liquids get into the vents as they could prevent the air conditioning from operating normally.

Changing the mode selection

N00736400493

To change the position and amount of air flowing from the vents, turn the mode selection dial. Refer to "Mode selection dial" on page 7-5, 7-8, 7-13, 7-19, 7-24.

Vents

These symbols are used in the next several illustrations to demonstrate the quantity of air coming from the vents.

- : Small amount of air from the vents
- ➔ : Medium amount of air from the vents
- ➔➔ : Large amount of air from the vents

Face position

Air flows only to the upper part of the passenger compartment.

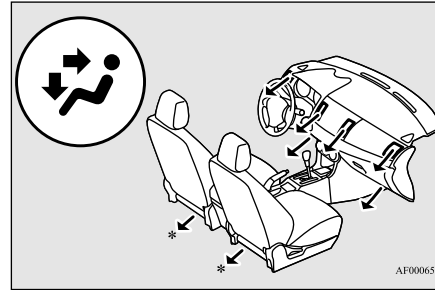

*- if so equipped

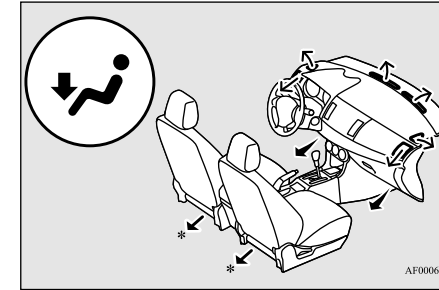

*- if so equipped

7

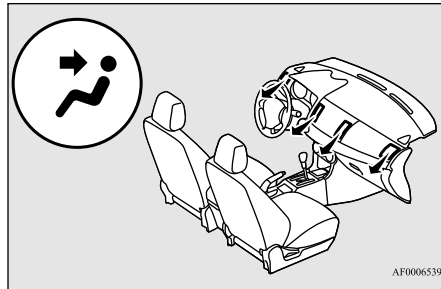

Foot/Face position

Air flows to the upper part of the passenger compartment, and flows to the leg area.

NOTE

- With the mode selection dial between the “➔➔” and “➔” positions, air flows mainly to the upper part of the passenger compartment. With the mode selection dial between the “➔” and “➔➔” positions, air flows mainly to the leg area.

Foot position

Air flows mainly to the leg area.

Foot/Defroster position



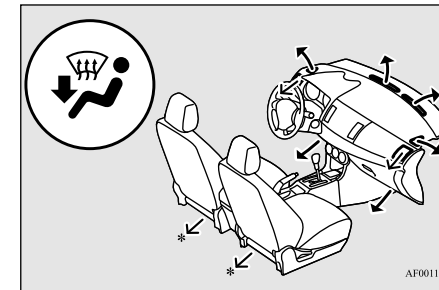

Air flows to the leg area, the windshield and the door windows.



*- if so equipped

Heater without air conditioning function (if so equipped)

NOTE

- With the mode selection dial between the “” and “” positions, air flows mainly to the leg area. With the mode selection dial between the “” and “” positions, air flows mainly to the windshield and the door windows.

Heater without air conditioning function (if so equipped)

N00737700031

The heater can only be used while the engine is running.

NOTE

- Button (A) is not available for use. The indicator below the button doesn't come on even if it is pushed.

Defroster position

7

Air flows mainly to the windshield and the door windows.

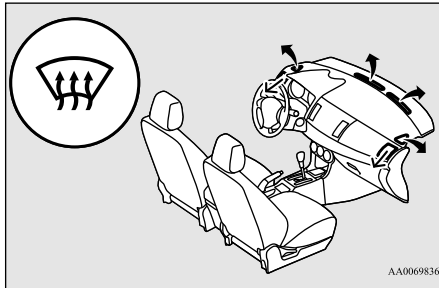

Control panel

N00737800029

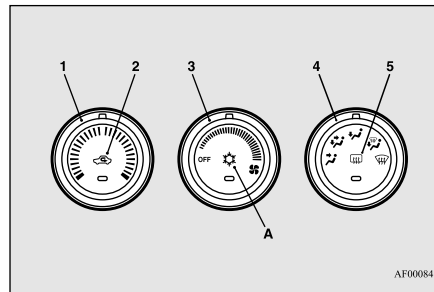

- 1- Temperature control dial
 - 2- Air selection switch
 - 3- Blower speed selection dial
 - 4- Mode selection dial
 - 5- Electric rear window defogger switch
- P. 5-158

Blower speed selection dial

N00737900020

When the ignition switch is in the “ON” position, select the blower speed by turning the blower speed selection dial.

Turning the dial clockwise will increase the blower speed; turning the dial counterclockwise will decrease it. When the dial is set to the “OFF” position, all fan-driven airflow will stop.

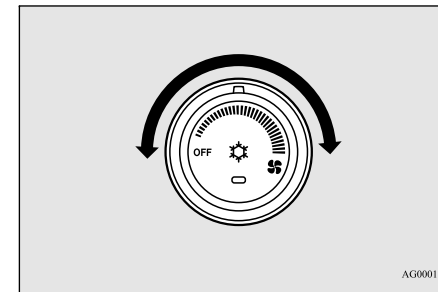

Heater without air conditioning function (if so equipped)

Temperature control dial

N00738000044

Turn the temperature control dial clockwise to make the air warmer. Turn it counterclockwise to make the air cooler.

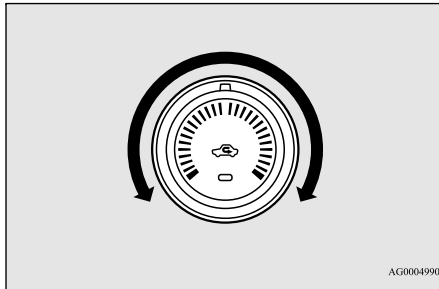

NOTE

- While the engine coolant temperature is low, the temperature of the air from the heater will be cool/cold until the engine warms up, even if you have selected warm air with the dial.

Mode selection dial

N00738100058

To change the amount of air flowing from the vents, turn the mode selection dial. Refer to “Changing the mode selection” on page 7-2.

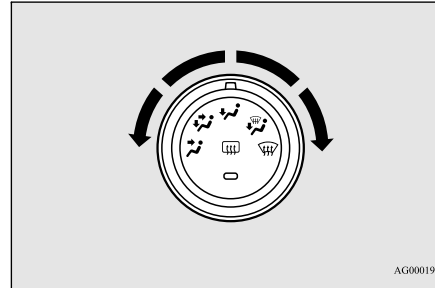

Air selection switch

N00738200033

Normally, use the outside air position to keep the windshield and side windows clear and to quickly remove fog or frost from the windshield.

To change the air selection, simply press the air selection switch. A sound will be made every time you push the switch.

- Outside air {Indicator light (A) OFF}
- Recirculation air {Indicator light (A) ON}

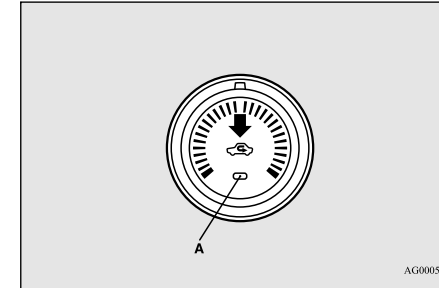

The air selection indicator light (A) shows the selected position.

7

If the outside air is dusty or contaminated in some way, use the recirculation position. Switch to the outside air position every now and then to keep the windows from fogging up.

CAUTION

- Using recirculated air for a long time may cause the windows to fog up.

Heater without air conditioning function (if so equipped)

Operating the system

N00738300034

Heating

Set the mode selection dial to the “” position and set the air selection switch (A) to the outside air position.

Turn the temperature control dial clockwise or counterclockwise to the desired temperature. Select the best speed to fit your needs.

7

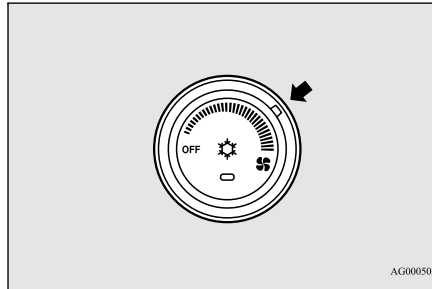

AG0005027

to the upper part of the passenger compartment.

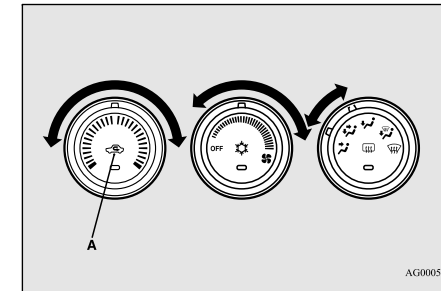

AG0005043

Combination of unheated air and heated air

N00738400022

Set the mode selection dial to the positions shown in the illustration and set the air selection switch (A) to the outside air position.

The air flow will be directed to the leg area and the upper part of the passenger compartment. Set the desired blower speed.

Warm air flows to the leg area and unheated or slightly warm air (depending upon the position of the temperature control dial) flows

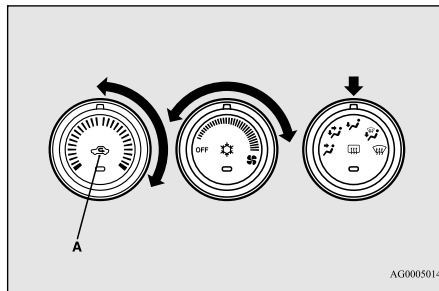

AG0005014

NOTE

- For quick heating, set the blower speed selection dial to the position shown in the illustration.

Defrosting or defogging the windshield and door windows

N00738500065

CAUTION

- For safety, make sure you have a clear view through all the windows.

Set the mode selection dial (between “” or “”) to remove frost or mist from the windshield and door window.

For ordinary defrosting

Use this setting to keep the windshield and door windows clear of mist, and to keep the leg area heated (when driving in rain or snow).

Manual air conditioning with MAX A/C mode (if so equipped)

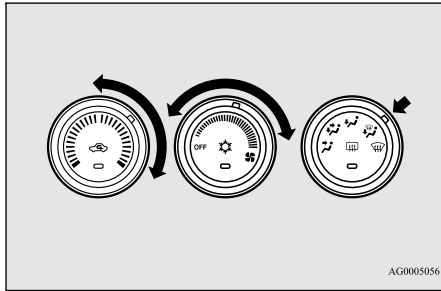

AG0005056

1. Set the mode selection dial to the “” position.
2. Select your desired blower speed by turning the blower speed selection dial.
3. Select your desired temperature by turning the temperature control dial.

For quick defrosting

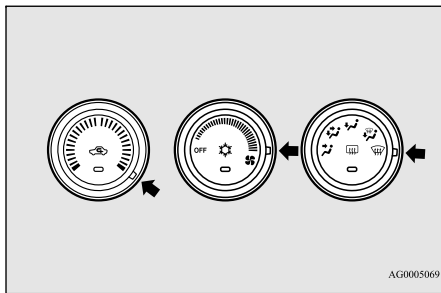

AG0005069

1. Set the mode selection dial to the “” position.

2. Set your blower to the maximum speed.
3. Set the temperature to the highest position.

NOTE

- To defog quickly, direct the air flow from the side vents toward the door windows.

Manual air conditioning with MAX A/C mode (if so equipped)

N00730300256

The air conditioning can only be used while the engine is running.

Control panel

N00730500216

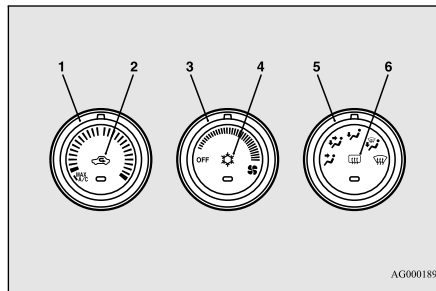

AG0001898

- 1- Temperature control dial

- 2- Air selection switch
- 3- Blower speed selection dial
- 4- Air conditioning switch
- 5- Mode selection dial
- 6- Electric rear window defogger switch
→P.5-158

Blower speed selection dial

N00736500146

When the ignition switch is in the “ON” position, select the blower speed by turning the blower speed selection dial.

Turning the dial clockwise will increase the blower speed; turning the dial counterclockwise will decrease it. When the dial is set to the “OFF” position, all fan-driven airflow will stop.

7

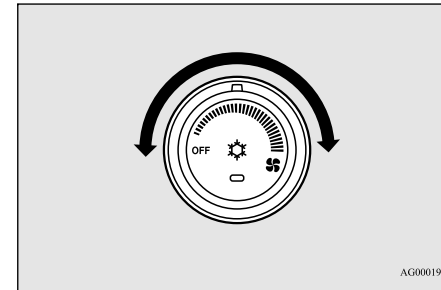

AG0001902

Manual air conditioning with MAX A/C mode (if so equipped)

Temperature control dial

N00736600219

Turn the temperature control dial clockwise to make the air warmer. Turn it counterclockwise to make the air cooler.

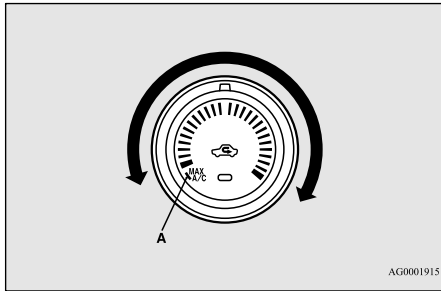

7

NOTE

- While the engine coolant temperature is low, the temperature of the air from the heater will be cool/cold until the engine warms up, even if you have selected warm air with the dial.
- For instructions on how to use the “MAX A/C” position (A), refer to “For quick cooling” on page 7-11.

Mode selection dial

N00736700151

To change the amount of air flowing from the vents, turn the mode selection dial. Refer to “Changing the mode selection” on page 7-2.

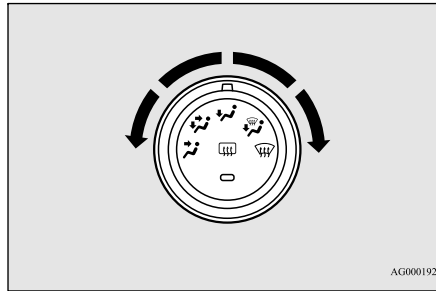

Air selection switch

N00736800367

Normally, use the outside air position to keep the windshield and side windows clear and to quickly remove fog or frost from the windshield.

To change the air selection, simply press the air selection switch. A sound will be made every time you push the switch.

- Outside air {Indicator light (A) OFF}
- Recirculated air {Indicator light (A) ON}

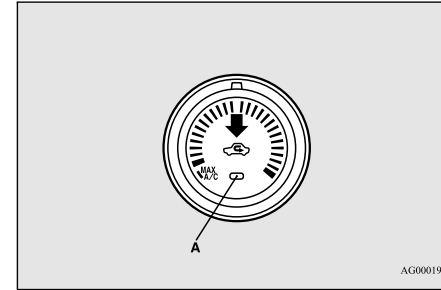

When the air conditioning turns on, the air selection is controlled automatically.

When the air conditioning turns off, the air selection automatically goes back to the outside air position.

The air selection indicator light (A) shows the selected position.

NOTE

- When the air conditioning operates with the air selection switch (A) in the outside air position, the system automatically determines whether to continue using outside air or to perform recirculation. If the outside temperature is high, the system selects recirculation to achieve rapid cooling and causes the air selection indicator in the switch to illuminate. When the air conditioning turns off or the blower speed selection dial is set to the “OFF” position, the air selection automatically goes back to the outside position.

Manual air conditioning with MAX A/C mode (if so equipped)

If the outside air is dusty or contaminated in some way, use the recirculation position. Switch to the outside air position every now and then to keep the windows from fogging up.

CAUTION

- Using recirculated air for a long time may cause the windows to fog up.

NOTE

- While the mode selection dial is set between “” and “” position, the air conditioning compressor will run automatically. The outside air position will also be selected automatically. (In this case, the air conditioning indicator will not change.)
- When the temperature control dial is set to the “MAX A/C” position, the air selection will be automatically set to the recirculation position.
- When the temperature control dial is in the “MAX A/C” position, if it is set to a position other than “MAX A/C”, the setting for the air selection switch is selected as described below. The selection of recirculated air or outside air depends on the setting before “MAX A/C” was used.
 - If automatic control was set: Automatic control is continued
 - If recirculated air was selected: Recirculated air is continued

NOTE

- If outside air was selected: Outside air is continued

Personalizing the air selection (Changing the function setting)

N00702100015

You can change the following functions to match your preference.

- Enable automatic air control: When the air conditioning operates, the air selection switch will be automatically controlled.
- Disable automatic air control: Even when the air conditioning operates, the air selection switch will not be automatically controlled.
- Changing the settings Press the air selection switch for about 10 seconds or longer. When the setting has changed, the system will beep and the indicator light will flash.
 - When the setting has changed from enabled to disabled, the system will beep three times and the indicator will flash three times.
 - When the setting has changed from disabled to enabled,

the system will beep two times and the indicator light will flash three times.

NOTE

- The factory setting is “Enable automatic air control”.
- While the mode selection dial is set between “” and “” position, the air selection will automatically change to the outside air position, even if the system is set to “Disable automatic air control”, in order to prevent windows from fogging up.

7

Air conditioning switch

N00731000423

Push the switch, and the air conditioning compressor will turn on. The air conditioning indicator light (A) will come on. A sound will be made every time you push the switch.

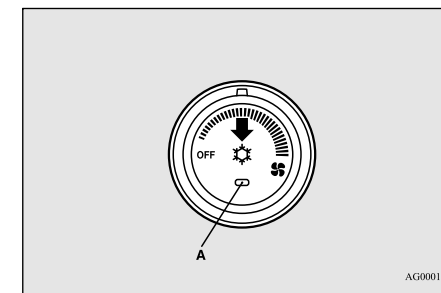

Comfort controls 7-9

Manual air conditioning with MAX A/C mode (if so equipped)

Push the switch again and the air conditioning compressor will stop and the indicator light (A) goes off.

CAUTION

- When using the air conditioning, the idling speed may slightly increase as the air conditioning compressor is switched on/off automatically. Especially for vehicles with a continuously variable transmission (CVT) or Twin Clutch SST, while the vehicle is stationary, fully depress the brake pedal to prevent the vehicle from creeping.

7

NOTE

- If a problem is detected in the air conditioning compressor, the air conditioning indicator light (A) blinks. Press the air conditioning switch once to turn it off, then once more to turn it back on. If the air conditioning indicator light (A) does not blink, there is no problem. If it does blink, have it checked at an authorized Mitsubishi Motors dealer or a repair facility of your choice.
- Sometimes, for example after using a high-pressure car wash, the condenser can get wet, and the air conditioning indicator light (A) blinks temporarily. Wait for a while, press the air conditioning switch once to turn the system off, then once more to turn it back on. Once the water evaporates, the blinking will stop.

Operating the air conditioning system

N00731100222

Heating

Set the mode selection dial to the “” position and set the air selection switch (A) to the outside air position.

Turn the temperature control dial clockwise or counterclockwise to the desired temperature. Select the best speed to fit your needs.

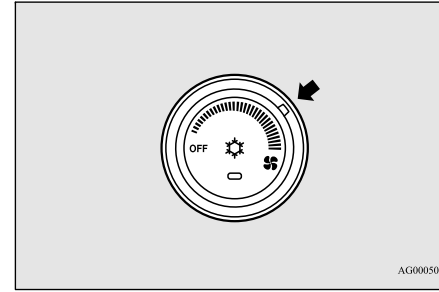

AG0005027

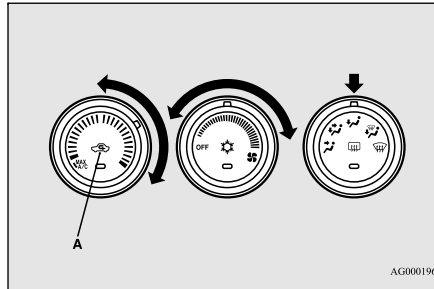

AG0001960

NOTE

- For quick heating, set the blower speed selection dial to the position shown in the illustration.

Manual air conditioning with MAX A/C mode (if so equipped)

Cooling

N00731200278

For ordinary cooling

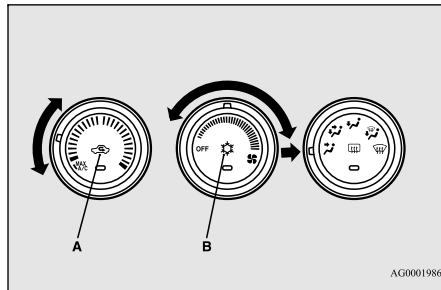

1. Set the mode selection dial to the “❄️” position.
2. Push the air selection switch (A) to set it to the outside air position.
3. Push the air conditioning switch (B).
4. Change the temperature by turning the control dial clockwise or counterclockwise.
5. Set the desired blower speed.

NOTE

- If the outside air is dusty or contaminated in some way, push the air selection switch (A) to set it to the recirculation position. Let in some outside air from time to time for good ventilation.

NOTE

- To cool the leg areas, set the mode selection dial to the “❄️” position.

For quick cooling

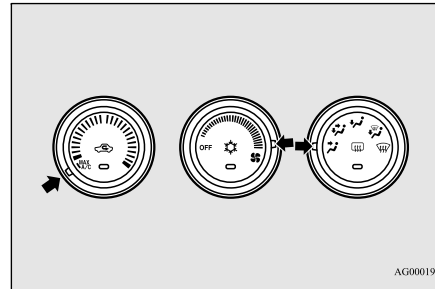

1. Set the mode selection dial to the “❄️” position.
2. Set the temperature control dial to the “MAX A/C” position.
3. Set the blower speed to the highest position.

NOTE

- When the temperature control dial is set to the “MAX A/C” position, the air conditioning compressor will run automatically and the light will come on. The recirculation position will be selected automatically. In this case, you cannot turn the air conditioning off or select the outside air position.

NOTE

- When the temperature control dial is set to a position other than “MAX A/C”, the air selection will automatically change to outside air. The air conditioning will revert to the previous condition in which the “MAX A/C” position was not selected.

Combination of unheated air and heated air

N00731300211

7

Set the mode selection dial to one of the positions shown in the illustration and set the air selection switch (A) to the outside air position.

Warm air flows to the leg area and unheated or slightly warm air (depending upon the position of the temperature control dial) flows to the upper part of the passenger compartment.

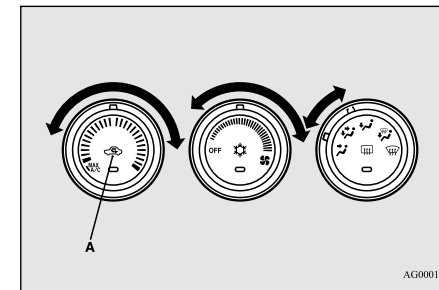

Manual air conditioning without MAX A/C mode (if so equipped)

Defrosting or defogging (windshield, door windows)

N00731400443

CAUTION

- For safety, make sure you have a clear view through all the windows.

7 Set the mode selection dial (between “” and “”) to remove frost or mist from the windshield and door window.

For ordinary defrosting

Use this setting to keep the windshield and door windows clear of mist, and to keep the leg area heated (when driving in rain or snow).

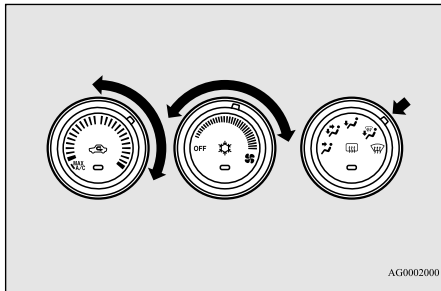

AG0002000

1. Set the mode selection dial to the “” position.

2. Select your desired blower speed by turning the blower speed selection dial.
3. Select your desired temperature by turning the temperature control dial.

For quick defrosting

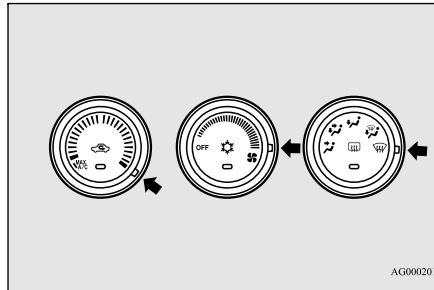

AG0002013

1. Set the mode selection dial to the “” position.
2. Set your blower to the maximum speed.
3. Set the temperature to the highest position.

NOTE

- While the mode selection dial is set between “” and “” position, the air conditioning compressor will run automatically. The outside air position will also be automatically selected. (In this case, the air conditioning indicator will not change.)

NOTE

- While the between “” and “” position is selected, you cannot turn the air conditioning off or select the recirculation position. This prevents the windows from fogging up.
- To defog quickly, direct the air flow from the side vents toward the door windows.
- When defrosting, do not set the temperature control dial near the “MAX A/C” cool position. This will blow cool air on the window glass and fog it up.

Manual air conditioning without MAX A/C mode (if so equipped)

N00730300269

The air conditioning can only be used while the engine is running.

Manual air conditioning without MAX A/C mode (if so equipped)

Control panel

N00730500229

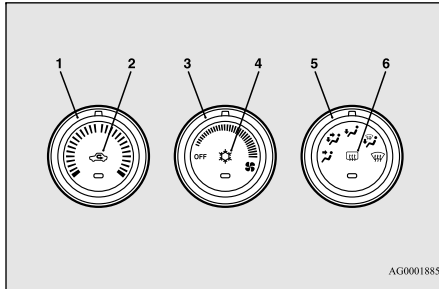

- 1- Temperature control dial
- 2- Air selection switch
- 3- Blower speed selection dial
- 4- Air conditioning switch
- 5- Mode selection dial
- 6- Electric rear window defogger switch
→P.5-158

Blower speed selection dial

N00736500133

When the ignition switch is in the “ON” position, select the blower speed by turning the blower speed selection dial.

Turning the dial clockwise will increase the blower speed; turning the dial counterclockwise will decrease it. When the dial is set to the “OFF” position, all fan-driven airflow will stop.

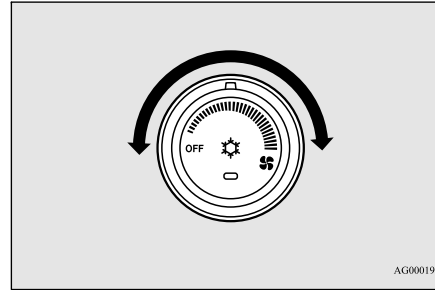

Temperature control dial

N00736600176

Turn the temperature control dial clockwise to make the air warmer. Turn it counterclockwise to make the air cooler.

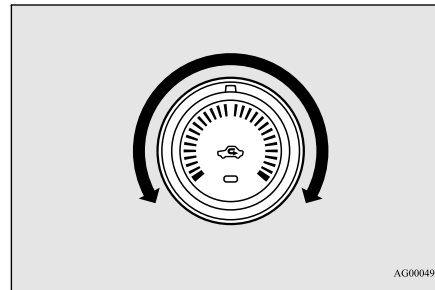

NOTE

- While the engine coolant temperature is low, the temperature of the air from the heater will be cool/cold until the engine warms up, even if you have selected warm air with the dial.

Mode selection dial

N00736700177

To change the amount of air flowing from the vents, turn the mode selection dial. Refer to “Changing the mode selection” on page 7-2.

7

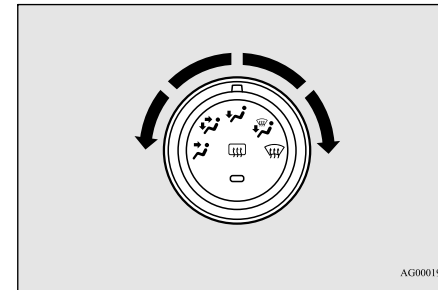

Air selection switch

N00736800279

Normally, use the outside air position to keep the windshield and side windows clear and to

Manual air conditioning without MAX A/C mode (if so equipped)

quickly remove fog or frost from the windshield.

To change the air selection, simply press the air selection switch. A sound will be made every time you push the switch.

- Outside air {Indicator light (A) OFF}
- Recirculated air {Indicator light (A) ON}

7

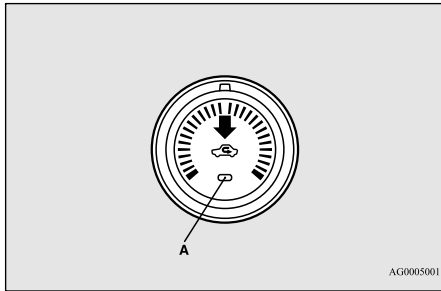

When the air conditioning turns on, the air selection is controlled automatically. The air selection indicator light (A) shows the selected position.

NOTE

- When the air conditioning operates with the air selection switch (A) in the outside air position, the system automatically determines whether to continue using outside air or to perform recirculation.

If the outside temperature is high, the system selects recirculation to achieve rapid cooling and causes the air selection indicator in the switch to illuminate. Press the air selection switch to return to outside air.

If the outside air is dusty or contaminated in some way, use the recirculation position. Switch to the outside air position every now and then to keep the windows from fogging up.

CAUTION

- Using recirculated air for a long time may cause the windows to fog up.

NOTE

- While the mode selection dial is set to the “” position, the air conditioning compressor will run automatically. The outside air position will also be selected automatically. (In this case, the air conditioning indicator will not change.)

Personalizing the air selection (Changing the function setting)



N00702100028

You can change the following functions to match your preference.

- Enable automatic air control:
When the air conditioning operates, the air selection switch will be automatically controlled.
- Disable automatic air control:
Even when the air conditioning operates, the air selection switch will not be automatically controlled.
- Changing the settings
Press the air selection switch for about 10 seconds or longer.
When the setting has changed, the system will beep and the indicator light will flash.
 - When the setting has changed from enabled to disabled, the system will beep three times and the indicator will flash three times.
 - When the setting has changed from disabled to enabled, the system will beep two times and the indicator light will flash three times.

Manual air conditioning without MAX A/C mode (if so equipped)

NOTE

- The factory setting is “Enable automatic air control”.
- While the mode selection dial is set between “” and “” position, the air selection will automatically change to the outside air position, even if the system is set to “Disable automatic air control”, in order to prevent windows from fogging up.

Air conditioning switch

N00731000436

Push the switch, and the air conditioning compressor will turn on. The air conditioning indicator light (A) will come on. A sound will be made every time you push the switch.

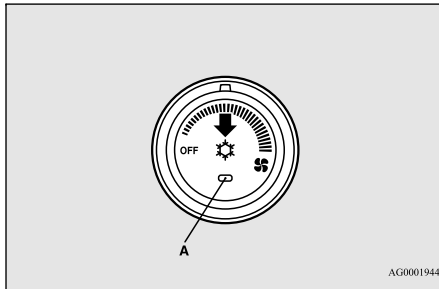

Push the switch again and the air conditioning compressor will stop and the indicator light (A) goes off.

CAUTION

- When using the air conditioning, the idling speed may slightly increase as the air conditioning compressor is switched on/off automatically. Especially for vehicles with a continuously variable transmission (CVT) or Twin Clutch SST, while the vehicle is stationary, fully depress the brake pedal to prevent the vehicle from creeping.

NOTE

- If a problem is detected in the air conditioning compressor, the air conditioning indicator light (A) blinks. Press the air conditioning switch once to turn it off, then once more to turn it back on. If the air conditioning indicator light (A) does not blink, there is no problem. If it does blink, have it checked at an authorized Mitsubishi Motors dealer or a repair facility of your choice.
- Sometimes, for example after using a high-pressure car wash, the condenser can get wet, and the air conditioning indicator light (A) blinks temporarily. Wait for a while, press the air conditioning switch once to turn the system off, then once more to turn it back on. Once the water evaporates, the blinking will stop.

Operating the air conditioning system

N00731100219

Heating

Set the mode selection dial to the “” position and set the air selection switch (A) to the outside air position.

Turn the temperature control dial clockwise or counterclockwise to the desired temperature. Select the best speed to fit your needs.

7

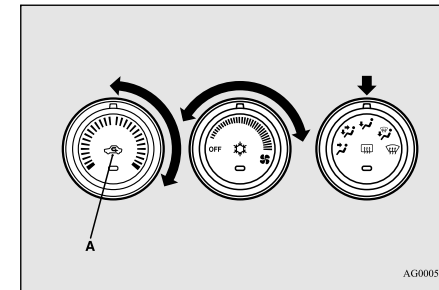

NOTE

- For quick heating, set the blower speed selection dial to the position shown in the illustration.

Manual air conditioning without MAX A/C mode (if so equipped)

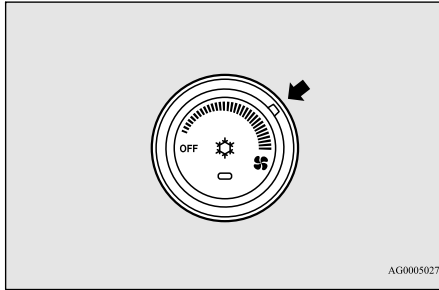

7

Cooling

N00731200249

For ordinary cooling

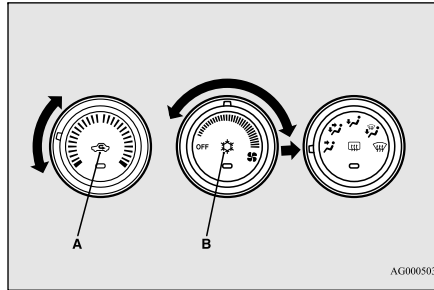

1. Set the mode selection dial to the “” position.
2. Push the air selection switch (A) to set it to the outside air position.
3. Push the air conditioning switch (B).
4. Change the temperature by turning the control dial clockwise or counterclockwise.
5. Set the desired blower speed.

NOTE

- If the outside air is dusty or contaminated in some way, push the air selection switch (A) to set it to the recirculation position. Let in some outside air from time to time for good ventilation.

NOTE

- To cool the leg areas, set the mode selection dial to the “” position.

Combination of unheated air and heated air

N00731300224

Set the mode selection dial to the positions shown in the illustration and set the air selection switch (A) to the outside air position.

The air flow will be directed to the leg area and the upper part of the passenger compartment. Set the desired blower speed.

Warm air flows to the leg area and unheated or slightly warm air (depending upon the position of the temperature control dial) flows to the upper part of the passenger compartment.

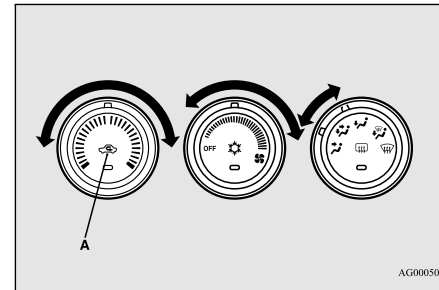

Automatic air conditioning with Fahrenheit scale (if so equipped)

Defrosting or defogging (windshield, door windows)

N00731400456

CAUTION

- For safety, make sure you have a clear view through all the windows.

Set the mode selection dial (between “”) and “”) to remove frost or mist from the windshield and door window.

For ordinary defrosting

Use this setting to keep the windshield and door windows clear of mist, and to keep the leg area heated (when driving in rain or snow).

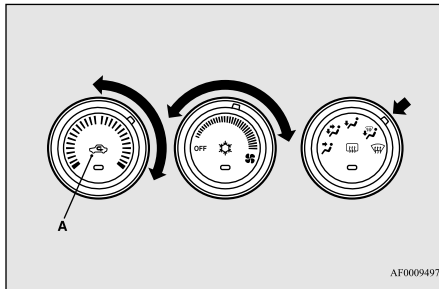

AF0009497

1. Set the mode selection dial to the “” position.

2. Set the air selection switch (A) to the outside air position.
3. Select your desired blower speed by turning the blower speed selection dial.
4. Select your desired temperature by turning the temperature control dial.

For quick defrosting

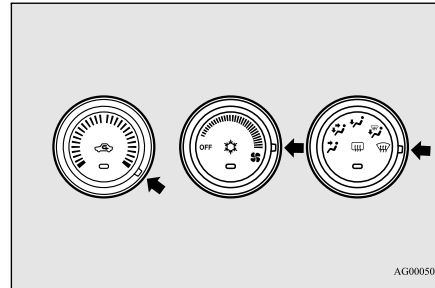

AG0005069

1. Set the mode selection dial to the “” position.
2. Set your blower to the maximum speed.
3. Set the temperature to the highest position.

NOTE

- While the mode selection dial is set to the “” position, the air conditioning compressor will run automatically. The outside air position will also be automatically selected.

NOTE

- To defog quickly, direct the air flow from the side vents toward the door windows.
- When defrosting, do not set the temperature control dial near the maximum cool position. This will blow cool air on the window glass and fog it up.

Automatic air conditioning with Fahrenheit scale (if so equipped)

7

N00731500226

The air conditioning can only be used while the engine is running.

Control panel

N00711801565

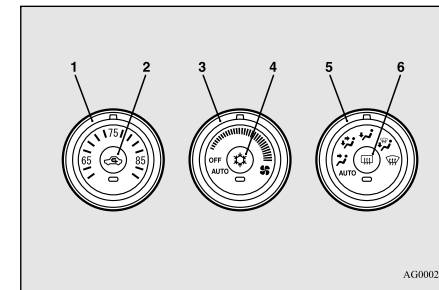

AG0002026

- 1- Temperature control dial
- 2- Air selection switch

Automatic air conditioning with Fahrenheit scale (if so equipped)

- 3- Blower speed selection dial
- 4- Air conditioning switch
- 5- Mode selection dial
- 6- Electric rear window defogger switch
→P.5-158

NOTE

- There is an interior air temperature sensor (A) in the illustrated position. Never place anything over the sensor, since doing so will prevent it from functioning properly.

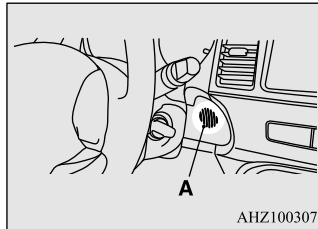

7

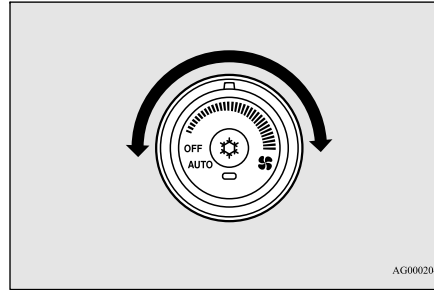

Temperature control dial

N00737001350

Use this dial to adjust the temperature in the passenger compartment. Turn the temperature control dial clockwise to make the air warmer. Turn it counterclockwise to make the air cooler.



Blower speed selection dial

N00736900094

When the ignition switch is in the “ON” position, select the blower speed by turning the blower speed selection dial.

Turning the dial clockwise will increase the blower speed; turning the dial counterclockwise will decrease it. When the dial is set to the “OFF” position, all fan-driven airflow will stop.

7-18 Comfort controls

NOTE

- While the engine coolant temperature is low, the temperature of the air from the heater will be cool/cold until the engine warms up, even if you have selected warm air with the dial.
- When the temperature is set to the highest or the lowest setting under the AUTO operation, the air selection and the air conditioning will be automatically changed as follows.
 - Quick Heating (When the temperature is set to the highest setting)
Outside air will be introduced and the air conditioning will stop. In this case, manual operation is possible.
 - Quick Cooling (When the temperature is set to the lowest setting)
Inside air will be recirculated and the air conditioning will operate. In this case, you cannot select outside air and turn the air conditioning off.

The above indicates the factory settings. You can personalize the air selection switch and air conditioning switch to match your personal preferences.

Contact your Mitsubishi Motors dealer or a repair facility of your choice for assistance. Refer to “Personalizing the air conditioning switch (Changing the function setting)” on page 7-20.

Refer to “Personalizing the air selection (Changing the function setting)” on page

Automatic air conditioning with Fahrenheit scale (if so equipped)

7-19.

Mode selection dial

N00737100093

To change the amount of air flowing from the vents, turn the mode selection dial. Refer to “Changing the mode selection” on page 7-2.

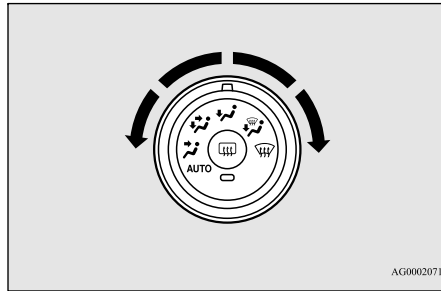

AG0002071

Air selection switch

N00737200238

Normally, use the outside air position to keep the windshield and side windows clear and to quickly remove fog or frost from the windshield.

To change the air selection, simply press the air selection switch. A sound will be made every time you press the switch.

- Outside air {Indicator light (A) OFF}

Outside air is introduced into the passenger compartment.

- Recirculated air {Indicator light (A) ON}
Air is recirculated inside the passenger compartment.

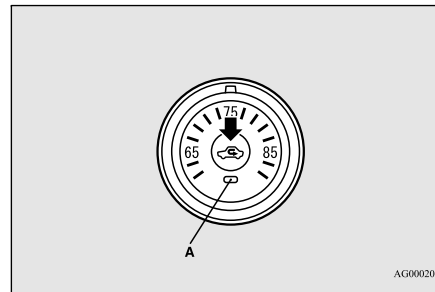

AG0002084

When the air conditioning turns on, the air selection is controlled automatically. When the air conditioning turns off, the air selection automatically goes back to the outside air position.

If high cooling performance is desired, or if the outside air is dusty or contaminated in some way, use the recirculation position. Switch to the outside air position every now and then to keep the windows from fogging up.

CAUTION

- Using recirculated air for a long time may cause the windows to fog up.

NOTE

- If the mode selection dial is set between “” and “”, you cannot turn the air conditioning off or select the recirculation position. This prevents the windows from fogging up.
- When the mode selection dial or the blower speed selection dial is set to the “AUTO” position again after manual operation, the air selection switch will also be automatically controlled.

7

**Personalizing the air selection
(Changing the function setting)**

N00760000018

You can change the following functions to match your preference.

- Enable automatic air control:
When the mode selection dial or the blower speed selection dial is set to the “AUTO” position, the air selection switch will also be automatically controlled.
- Disable automatic air control:
Even when the mode selection dial or the blower speed selection dial is set to the “AUTO” position, the air selection switch will not be automatically controlled.
- Changing the settings

Automatic air conditioning with Fahrenheit scale (if so equipped)

Press the air selection switch for about 10 seconds or longer.

When the setting has changed, the system will beep and the indicator light will flash.

- When the setting has changed from enabled to disabled, the system will beep three times and the indicator will flash three times.
- When the setting has changed from disabled to enabled, the system will beep two times and the indicator light will flash three times.

7

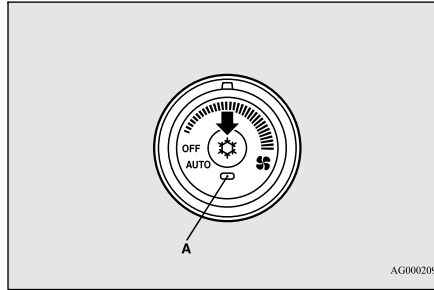

Push the switch again and the air conditioning compressor will stop and the indicator light (A) goes off.

NOTE

- The factory setting is “Enable automatic air control”.
- While the mode selection dial is set between “” and “” position, the air selection will automatically change to the outside air position, even if the system is set to “Disable automatic air control”, in order to prevent windows from fogging up.

CAUTION

- When using the air conditioning, the idling speed may slightly increase as the air conditioning compressor is switched on/off automatically. Especially for vehicles with a continuously variable transmission (CVT) or Twin Clutch SST, while the vehicle is stationary, fully depress the brake pedal to prevent the vehicle from creeping.

NOTE

- If a problem is detected in the air conditioning compressor, the air conditioning indicator light (A) blinks. Press the air conditioning switch once to turn it off, then once more to turn it back on. If the air conditioning indicator light does not blink there is no problem. If it does blink, have it checked at an authorized Mitsubishi Motors dealer or a repair facility of your choice.
- Sometimes, for example after using a high-pressure car wash, the condenser can get wet, and the air conditioning indicator light (A) blinks temporarily. Wait for a while, press the air conditioning switch once to turn the system off, then once more to turn it back on. Once the water evaporates, the blinking will stop.

Air conditioning switch

N00737300297

Push the switch, and the air conditioning compressor will turn on. The air conditioning indicator light (A) will come on.

A sound will be made every time you push the switch.

Personalizing the air conditioning switch (Changing the function setting)

N00759800032

You can change the following functions to match your preference.

- Enable automatic air conditioning control:

Automatic air conditioning with Fahrenheit scale (if so equipped)

When the mode selection dial or blower speed selection dial has been set to the “AUTO” position or when the temperature control dial has been set to the minimum temperature, the air conditioning switch is automatically controlled.

- Disable automatic air conditioning control:

The air conditioning switch is not automatically controlled, unless the air conditioning switch is used.

- Changing the settings:

Press the air conditioning switch for about 10 seconds or longer.

When the setting has changed, the system will beep and the indicator light will flash.

- When the setting has changed from enabled to disabled, the system will beep three times and the indicator will flash three times.
- When the setting has changed from disabled to enabled, the system will beep two times and the indicator light will flash three times.

NOTE

- The factory setting is “Enable automatic air conditioning control”.

NOTE

- While the mode selection dial is set between “” and “” position, the air conditioning will run automatically, even if the system is set to “Disable automatic air conditioning control”, in order to prevent windows from fogging up.

Operating the air conditioning system (automatic mode)

N00731701414

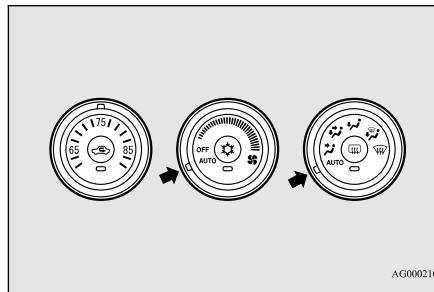

In normal conditions, use the system in the AUTO mode and follow these procedures:

1. Set the blower speed selection dial to the “AUTO” position.

2. Select the temperature control dial to the desired temperature. The temperature can be set within a range of around 61 to 89. The temperature will increase as the dial is turned to the right.
3. Set the mode selection dial to the “AUTO” position.

The vents, recirculation/outside air, blower speed, and ON/OFF of air conditioning will be controlled automatically.

7

NOTE

- Set the temperature at about 75 under normal conditions.
- While the engine coolant temperature is low, the temperature of the air from the heater will be cool/cold until the engine warms up, even if you have selected warm air with the dial. To prevent the windshield and windows from fogging up, the vent mode will be changed to “” or “” and the blower speed will be reduced.

Operating the air conditioning system (manual mode)

N00731800072

Blower speed and vent mode may be controlled manually by setting the blower speed selection dial and the mode selection dial to the desired positions. To return to automatic

Automatic air conditioning with Celsius scale (if so equipped)

operation, set the dials to the “AUTO” position.

Defrosting or defogging (windshield, door windows)

N00732400280

CAUTION

- For safety, make sure you have a clear view through all the windows.

7

To remove frost or mist from the windshield and door windows, use the mode selection dial (“” or “”).

For ordinary defrosting

Use this setting to keep the windshield and door windows clear of mist, and to keep the leg area heated (when driving in rain or snow).

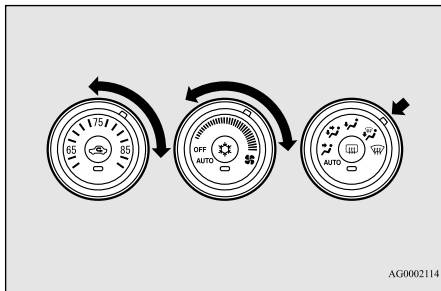

AG0002114

1. Set the mode selection dial to the “” position.
2. Select your desired blower speed by turning the blower speed selection dial.
3. Select your desired temperature by turning the temperature control dial.

For quick defrosting

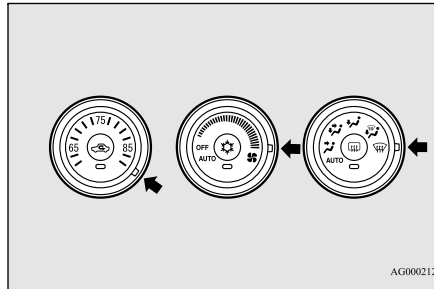

AG0002127

1. Set the mode selection dial to the “” position.
2. Set your blower to the maximum speed.
3. Set the temperature to the highest position.

NOTE

- While the mode selection dial is set between “” and “” position, the air conditioning compressor will run automatically. The outside air position will also be selected automatically.

NOTE

- If the mode selection dial is set between “” and “” you cannot turn the air conditioning off or select the recirculation position. This prevents the windows from fogging up.
- To defog quickly, direct the air flow from the side vents toward the door windows.
- When defrosting, do not set the temperature control dial to the maximum cool position. This will blow cool air on the window glass and fog it up.

Automatic air conditioning with Celsius scale (if so equipped)

N00731500239

The air conditioning can only be used while the engine is running.

Automatic air conditioning with Celsius scale (if so equipped)

Control panel

N00711801594

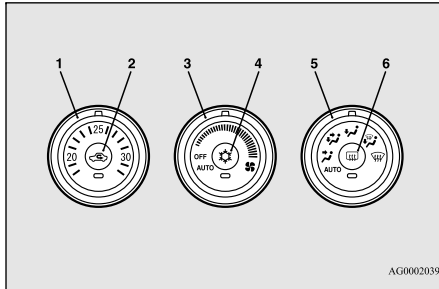

- 1- Temperature control dial
- 2- Air selection switch
- 3- Blower speed selection dial
- 4- Air conditioning switch
- 5- Mode selection dial
- 6- Electric rear window defogger switch
→P. 5-158

NOTE

- There is an interior air temperature sensor (A) in the illustrated position. Never place anything over the sensor, since doing so will prevent it from functioning properly.

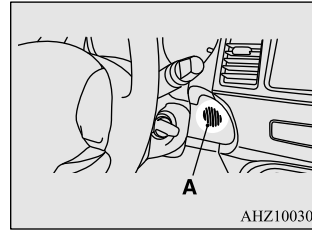

Blower speed selection dial

N00736900111

When the ignition switch is in the “ON” position, select the blower speed by turning the blower speed selection dial. Turning the dial clockwise will increase the blower speed; turning the dial counterclockwise will decrease it. When the dial is set to the “OFF” position, all fan-driven airflow will stop.

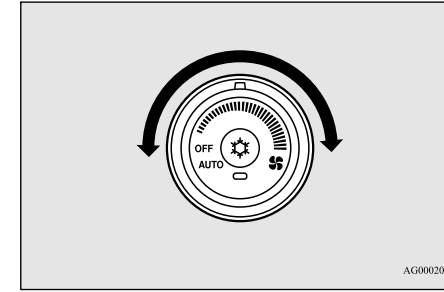

7

Temperature control dial

N00737000281

Use this dial to adjust the temperature in the passenger compartment. Turn the temperature control dial clockwise to make the air warmer. Turn it counterclockwise to make the air cooler.

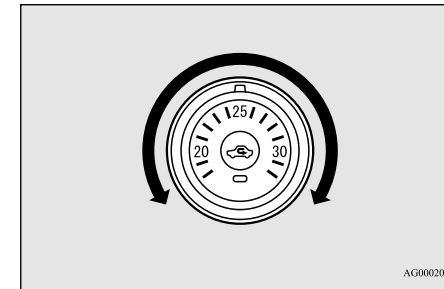

Automatic air conditioning with Celsius scale (if so equipped)

NOTE

- While the engine coolant temperature is low, the temperature of the air from the heater will be cool/cold until the engine warms up, even if you have selected warm air with the dial.
- When the temperature is set to the highest or the lowest setting under the AUTO operation, the air selection and the air conditioning will be automatically changed as follows. Also, if the air selection is operated manually after an automatic changeover, manual operation will be selected.
 - Quick Heating (When the temperature is set to the highest setting)
Outside air will be introduced and the air conditioning will stop.
 - Quick Cooling (When the temperature is set to the lowest setting)
Inside air will be recirculated and the air conditioning will operate.

7

The above indicates the factory settings. You can personalize the air selection switch and air conditioning switch to match your personal preferences.

Contact your Mitsubishi Motors dealer or a repair facility of your choice for assistance. Refer to “Personalizing the air conditioning switch (Changing the function setting)” on page 7-26.

Refer to “Personalizing the air selection (Changing the function setting)” on page

7-24 Comfort controls

7-25.

Mode selection dial

N00737100136

To change the amount of air flowing from the vents, turn the mode selection dial. Refer to “Changing the mode selection” on page 7-2.

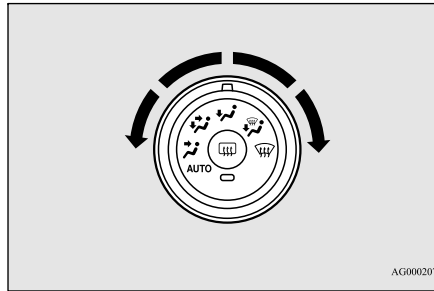

Air selection switch

N00737200241

Normally, use the outside air position to keep the windshield and side windows clear and to quickly remove fog or frost from the windshield.

To change the air selection, simply press the air selection switch. A sound will be made every time you press the switch.

- Outside air {Indicator light (A) OFF}

Outside air is introduced into the passenger compartment.

- Recirculated air {Indicator light (A) ON}
Air is recirculated inside the passenger compartment.

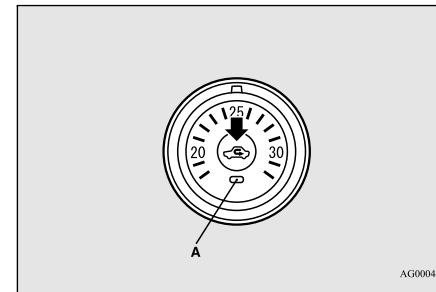

When the air conditioning turns on, the air selection is controlled automatically. When the air conditioning turns off, the air selection automatically goes back to the outside air position.

If high cooling performance is desired, or if the outside air is dusty or contaminated in some way, use the recirculation position. Switch to the outside air position every now and then to keep the windows from fogging up.

CAUTION

- Using recirculated air for a long time may cause the windows to fog up.

Automatic air conditioning with Celsius scale (if so equipped)

Personalizing the air selection (Changing the function setting)

N0076000050

You can change the following functions to match your preference.

- **Enable automatic air control:**
When the mode selection dial or the blower speed selection dial is set to the “AUTO” position, the air selection switch will also be automatically controlled.
- **Disable automatic air control:**
Even when the mode selection dial or the blower speed selection dial is set to the “AUTO” position, the air selection switch will not be automatically controlled.
- **Changing the settings**
Press the air selection switch for about 10 seconds or longer.
When the setting has changed, the system will beep and the indicator light will flash.
 - When the setting has changed from enabled to disabled, the system will beep three times and the indicator will flash three times.
 - When the setting has changed from disabled to enabled, the system will beep two times and the indicator light will flash three times.

NOTE

- The factory setting is “Enable automatic air control”.
- While the mode selection dial is set to the “” position, the air selection will automatically change to the outside air position, even if the system is set to “Disable automatic air control”, in order to prevent windows from fogging up.

Air conditioning switch

N00737300301

Push the switch, and the air conditioning compressor will turn on. The air conditioning indicator light (A) will come on.

A sound will be made every time you push the switch.

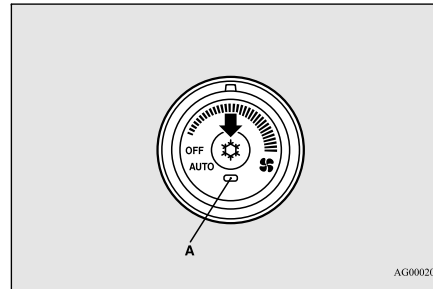

Push the switch again and the air conditioning compressor will stop and the indicator light (A) goes off.

CAUTION

- When using the air conditioning, the idling speed may slightly increase as the air conditioning compressor is switched on/off automatically. Especially for vehicles with a continuously variable transmission (CVT) or Twin Clutch SST, while the vehicle is stationary, fully depress the brake pedal to prevent the vehicle from creeping.

7

NOTE

- If a problem is detected in the air conditioning compressor, the air conditioning indicator light (A) blinks. Press the air conditioning switch once to turn it off, then once more to turn it back on. If the air conditioning indicator light does not blink there is no problem. If it does blink, have it checked at an authorized Mitsubishi Motors dealer or a repair facility of your choice.
- Sometimes, for example after using a high-pressure car wash, the condenser can get wet, and the air conditioning indicator light (A) blinks temporarily. Wait for a while, press the air conditioning switch once to turn the system off, then once more to turn it back on. Once the water evaporates, the blinking will stop.

Automatic air conditioning with Celsius scale (if so equipped)

Personalizing the air conditioning switch (Changing the function setting)

N00759800029

You can change the following functions to match your preference.

7

- Enable automatic air conditioning control:
When the mode selection dial or blower speed selection dial has been set to the “AUTO” position or when the temperature control dial has been set to the minimum temperature, the air conditioning switch is automatically controlled.

- Disable automatic air conditioning control:
The air conditioning switch is not automatically controlled, unless the air conditioning switch is used.

- Changing the settings
Press the air conditioning switch for about 10 seconds or longer.
When the setting has changed, the system will beep and the indicator light will flash.
 - When the setting has changed from enabled to disabled, the system will beep three times and the indicator will flash three times.
 - When the setting has changed from disabled to enabled,

the system will beep two times and the indicator light will flash three times.

NOTE

- The factory setting is “Enable automatic air conditioning control”.
- While the mode selection dial is set to the “” position, the air conditioning will run automatically, even if the system is set to “Disable automatic air conditioning control”, in order to prevent windows from fogging up.

Operating the air conditioning system (automatic mode)

N00731701427

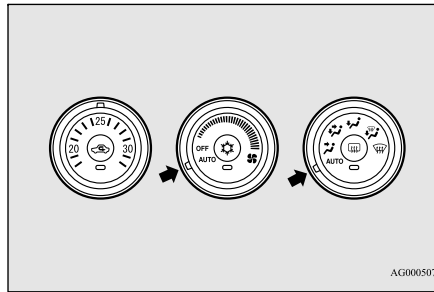



AG0005072

In normal conditions, use the system in the AUTO mode and follow these procedures:

1. Set the blower speed selection dial to the “AUTO” position.
2. Select the temperature control dial to the desired temperature. The temperature can be set within a range of around 18 to 32. The temperature will increase as the dial is turned to the right.
3. Set the mode selection dial to the “AUTO” position.

The vents, recirculation/outside air, blower speed, and ON/OFF of air conditioning will be controlled automatically.

NOTE

- Set the temperature at about 25 under normal conditions.
- While the engine coolant temperature is low, the temperature of the air from the heater will be cool/cold until the engine warms up, even if you have selected warm air with the dial. To prevent the windshield and windows from fogging up, the vent mode will be changed to “” or “” and the blower speed will be reduced.

Operating the air conditioning system (manual mode)

N00731800098

Blower speed and vent mode may be controlled manually by setting the blower speed

Automatic air conditioning with Celsius scale (if so equipped)



selection dial and the mode selection dial to the desired positions. To return to automatic operation, set the dials to the “AUTO” position.

Defrosting or defogging (windshield, door windows)

N00732400440

CAUTION

- For safety, make sure you have a clear view through all the windows.

To remove frost or mist from the windshield and door windows, use the mode selection dial (“” or “”).

For ordinary defrosting

Use this setting to keep the windshield and door windows clear of mist, and to keep the

leg area heated (when driving in rain or snow).

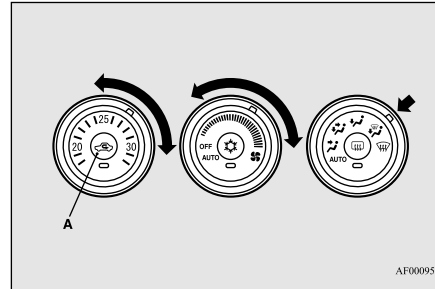

1. Set the mode selection dial to the “” position.
2. Set the air selection switch (A) to the outside air position.
3. Select your desired blower speed by turning the blower speed selection dial.
4. Select your desired temperature by turning the temperature control dial.

For quick defrosting

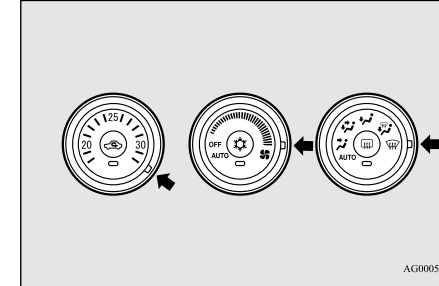



AG0005098

7

1. Set the mode selection dial to the “” position.
2. Set your blower to the maximum speed.
3. Set the temperature to the highest position.

NOTE

- While the mode selection dial is set to the “” position, the air conditioning compressor will run automatically. The outside air position will also be selected automatically.
- While the “” position is selected, you cannot turn the air conditioning off or select the recirculation position. This prevents the windows from fogging up.
- To defog quickly, direct the air flow from the side vents toward the door windows.

Important air conditioning operating tips

NOTE

- When defrosting, do not set the temperature control dial to the maximum cool position. This will blow cool air on the window glass and fog it up.

Important air conditioning operating tips

N00733700280

7

1. Park the vehicle in the shade whenever possible. Parking in the hot sun makes the vehicle interior extremely hot which then requires more time to cool. If it is necessary to park in the sun, open the windows for the first few minutes of air conditioning to expel the hot air.
2. Afterwards, keep the windows closed when the air conditioning is in use. The entry of outside air through open windows will reduce cooling efficiency.
3. When running the air conditioning, make sure the air intake, which is located in front of the windshield, is free of obstructions such as leaves. Leaves collected in the air-intake chamber may reduce air flow and plug the water drains.

Air conditioning system refrigerant and lubricant recommendations

If the air conditioning seems less effective than usual, the cause might be a refrigerant leak.

Have the system inspected by your authorized Mitsubishi Motors dealer or a repair facility of your choice.

CAUTION

- The air conditioning system in your vehicle must be charged with the refrigerant HFC-134a and the lubricant SUN-PAG56. Use of any other refrigerant or lubricant will cause severe damage and may require replacing your vehicle's entire air conditioning system. The release of refrigerant into the atmosphere is not recommended. The new refrigerant HFC-134a in your vehicle is designed not to harm the earth's ozone layer. However, it may contribute slightly to global warming. It is recommended that the old refrigerant be saved and recycled for future use.

During a long period of disuse

The air conditioning should be operated for at least five minutes each week, even in cold weather. This includes the quick defrosting mode. Operating the air conditioning system weekly maintains lubrication of the compressor internal parts to keep the air conditioning in the best operating condition.

Air purifier

N00733800151

The air conditioning system is equipped with an air filter to remove pollen and dust. The air filter's ability to collect pollen and dirt is reduced as it becomes dirty, so replace it periodically. For the maintenance interval, refer to the "WARRANTY AND MAINTENANCE MANUAL".

NOTE

- Operation in certain conditions such as driving on a dusty road and frequent use of the air conditioning can lead to reduction of service life of the filter. When you feel that the air flow is lower than normal or when the windshield or windows start to fog up easily, replace the air filter. Contact your Mitsubishi Motors dealer or a repair facility of your choice for assistance.

AM/FM radio/CD player (if so equipped)

N00734302098

The audio system can only be used when the ignition switch is in the “ON” or “ACC” position.

NOTE

- To listen to the audio system while the engine is not running, turn the ignition switch to the “ACC” position. If the ignition switch is left in the “ACC” position, the accessory power will automatically turn off after a certain period of time and you will no longer be able to use the audio system. The accessory power comes on again if the ignition switch is turned from the “ACC” position. Refer to “ACC power auto-cutout function” on page 5-54.
- If a cellular phone is used inside the vehicle, it may create noise in the audio equipment. This does not mean that anything is wrong with your audio equipment. In such a case, use the cellular phone at a place as far away as possible from the audio equipment.

NOTE

- If foreign objects or water get into the audio equipment, or if smoke or a strange odor comes from it, immediately turn off the audio system and have it checked at an authorized Mitsubishi Motors dealer or a repair facility of your choice. Never try to repair it yourself. Avoid using the audio system until it is inspected by a qualified person.
- If the audio system is damaged by foreign objects, water, or fire, have the system checked by a qualified Mitsubishi Motors technician.
- The audio amplifier (if so equipped) is located under the front left seat. Do not subject the amplifier to a strong impact. It could damage the amplifier or malfunctioning could result.

Important Points on Usage

N00715000021

iPod/iPhone Playback Function (if so equipped)

- This product supports audio playback from iPod/iPhone devices, however differing versions mean that playback cannot be guaranteed.

AM/FM radio/CD player (if so equipped)

- Please be aware that depending on the iPod/iPhone model or version, operation may differ.

How to Clean

N00715200023

- If the product becomes dirty, wipe with a soft cloth.
- If very dirty, use a soft cloth dipped in neutral detergent diluted in water, and then wrung out. Do not use benzene, thinners, or other chemical wipes. This may harm the surface.

7

Trademarks

N00715300066

- Product names and other proper names are the trademarks or registered trademarks of their respective owners.
- Furthermore, even if there is no specific denotation of trademarks or registered trademarks, these are to be observed in their entirety.



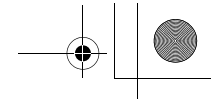

AM/FM radio/CD player (if so equipped)

7

“Made for iPod”, “Made for iPhone” mean that an electronic accessory has been designed to connect specifically to iPod or iPhone, respectively, and has been certified by the developer to meet Apple performance standards. iPhone, iPod, iPod classic, iPod nano, and iPod touch are trademarks of Apple Inc., registered in the U.S. and other countries. Apple is not responsible for the operation of this device or its compliance with safety and regulatory standards.

NOTE

- iPod and iTunes licensing allows individual users to privately reproduce and play back non-copyrighted material as well as material that may be legally copied and reproduced. Infringement of copyright is prohibited.

NOTE







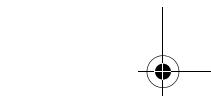



- For vehicles with a Bluetooth® 2.0 interface, the types of devices that can be connected may vary.
[For vehicles sold in U.S.A.]
For details, access the Mitsubishi Motors North America website.
[For vehicles sold in Canada and Mexico]
For details, access the Mitsubishi Motors website. Please read and agree to the “Warning about Links to the Web Sites of Other Companies”. The websites mentioned above may connect you to websites other than the Mitsubishi Motors website.
<http://www.mitsubishi-motors.com/en/products/index.html>



7-30 Comfort controls



AM/FM radio/CD player (if so equipped)

iPod		iPod classic		
				
iPod 5th generation (video) 60GB 80GB	iPod 5th generation (video) 30GB	iPod classic 160GB (2009)	iPod classic 160GB (2007)	iPod classic 80GB
iPod nano				
				
iPod nano 6th generation 8GB 16GB	iPod nano 5th generation (video camera) 8GB 16GB	iPod nano 4th generation (video) 8GB 16GB		
				
iPod nano 3rd generation (video) 4GB 8GB	iPod nano 2nd generation (aluminum) 2GB 4GB 8GB	iPod nano 1st generation 1GB 2GB 4GB		

AA5013326

7

Comfort controls 7-31

Handling of Discs

7

iPod touch



iPod touch

4th generation
8GB 32GB 64GB

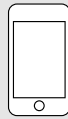

iPod touch

3rd generation
32GB 64GB



iPod touch

2nd generation
8GB 16GB 32GB



iPod touch

1st generation
8GB 16GB 32GB

iPhone



iPhone 4S

16GB 32GB 64GB



iPhone 4

16GB 32GB

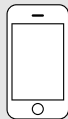

iPhone 3GS

8GB 16GB 32GB



iPhone 3G

8GB 16GB

AJ5100128

Handling of Discs

N00715400025

handling of discs.

This explains care that should be taken in the

7-32 Comfort controls

Handling of Discs

Important Points on Handling

- Fingerprints or other marks on the read surface of the disc may result in its content being more difficult to read. When holding the disc, grip both edges, or one edge and the center hole, in order that the read surface is not touched.
- Do not affix paper or stickers, or otherwise damage the disc.
- Do not forcefully insert a disc if another is already within the device. This can result in damage to discs, or malfunction.

Cleaning

- Periodically clean the read surface of the disc. When cleaning, do not wipe in a circular motion. Instead, wipe gently outwards from the center of the disc to the outer edge.
- New discs may have burring around the outer edge or in the hole in the center. Ensure you check for these. If there are burrs, these may lead to faulty operation, therefore ensure these are removed.

Important Points on Storage

- When not using discs, ensure these are kept in cases, and stored out of direct sunlight.

- If discs are not going to be used for a long period of time, remove these from the product.

Disc Playback Environment

In cold environments such as in mid-winter when the interior of the vehicle is cold, turning the heater on and immediately trying to use the product may cause condensation (water droplets) to form on the disc and internal optical components, and this may prevent the product from operating correctly.

In these conditions, remove the disc, and wait a short time before use.





Copyright

Actions such as unauthorized reproduction, broadcast, public performance, or rental of discs that comprise other than personal use are prohibited by law.

Types of Disc That Can Be Played Back

N00715500026

The following marks are printed on the disc label, package, or jacket.

Type	Size	Maximum playback time	Comments
CD-DA 	5 inches (12 cm)	74 minutes	—
CD-TEXT 	5 inches (12 cm)	74 minutes	—
CD-R/RW  	5 inches (12 cm)	—	•Disc containing MP3 files

7

Discs That May Not Be Played Back

- Playback of discs other than those described in “Types of Disc That Can Be Played Back” is not guaranteed.
- 3 inches (8 cm) discs may not be used.
- Do not insert irregularly-shaped discs (for example, heart-shaped), as these may result in malfunction. Additionally, discs that have transparent portions may not be played back.

Audio Files (MP3/WMA/AAC)

- Discs that have not been finalized cannot be played back.
- Even if recorded using the correct format on a recorder or computer, application software settings and environments; disc peculiarities, damage, or marking; or dirt or condensation on the lens inside the product may render the disc unplayable.
- Depending on the disc, some functions may not be used, or the disc may not play back.
- Do not use discs with cracks or warps.
- If the disc has stickers affixed, remains from removed stickers, or affixed adhesive, then do not use the disc.
- Discs that have decorative labels or stickers may not be used.

7

Nonstandard CDs

This product will play back audio CDs, however please be aware of the following points regarding CD standards.

- Ensure that you use discs with  on the label surface.
- Playback of other than standard CDs is not guaranteed. Even if the audio can be played back, the audio quality cannot be guaranteed.
- When playing back other than standard CDs, the following may occur.

- There may be noise during playback.
- There may be jumping in the audio.
- The disc may not be recognized.
- The first track may not be played back.
- It may take longer than usual until start of playback of tracks.
- Playback may start from within the track.
- Some parts may not be played back.
- Tracks may freeze during playback.
- Tracks may be displayed erroneously.

Audio Files (MP3/WMA/AAC)

N00715600027

This product can play back MP3/WMA/AAC format audio files recorded on CD-ROM, CD-R/RW, and USB devices.

There are limitations on the files and media that can be used, therefore read the following prior to recording MP3/WMA/AAC format audio files on discs or USB devices.

Additionally, ensure you read the user manuals for your CD-R/RW drive and the writing software, and ensure these are used correctly. If the MP3/WMA/AAC format audio files includes title information or other data, then this can be displayed.

CAUTION

- CD-ROM and CD-R/RW media can only play back MP3 format audio files.
- Actions such as copying audio CDs or files and either distributing these to others for free or for charge, or uploading files via the Internet or other means to servers is an infringement of the law.
- Do not append the file extensions “.mp3”, “.wma”, or “.m4a”, to other than MP3/WMA/AAC format files. Playing back discs with these types of files recorded upon them may cause the files to be incorrectly identified for playback, which may lead to loud noise, resulting in speaker damage or accident.

NOTE

- Depending on the condition of the disc recorder or recording software used, correct playback may not be possible. In these cases, refer to the user manual for your product or software.
- Depending on your computer's operating system, version, software, or settings, files may not have a file extension appended. In these cases, append the file extensions “.mp3”, “.wma”, or “.m4a” when copying the files.
- Files larger than 2GB in size cannot be played back.

Audio Files (MP3/WMA/AAC)

Data Formats That Can Be Played Back

N0071570028

Data formats that can be played on discs (CD-ROM, CD-R/RW) and USB devices differ.

Data format	DISC	USB device
MP3	○	○
WMA	X	○
AAC	X	○

Folder Structure

N0071580029

Up to 8 folder levels can be recognized. You can create a folder structure as in Genre - Artist - Album - Track (MP3/WMA/AAC format audio files) for management of tracks.

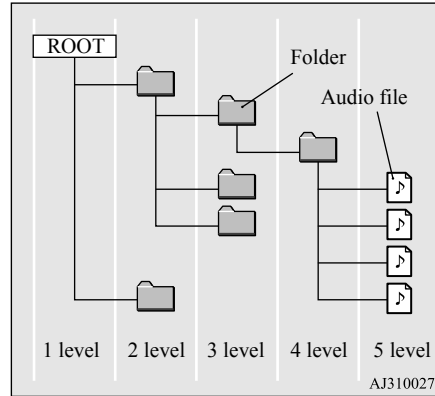

Name	Specification	Explanation
Format specifications	ISO9660	Level 1 Maximum 8 character file name, and 3 character file extension. (single-byte alphanumeric capital letters, numerals, “_” may be used)
	ISO9660 extension	Joliet Files names up to a maximum 64 characters can be used.
Multisession	Not supported (only first session supported)	
Maximum number of levels	8 levels (if the root is the 1st level)	
Maximum folder number	700 folders (including root)	

Audio Files (MP3/WMA/AAC)

Name	Specification	Explanation
Maximum file number* ¹	65,535 files (total number on media. Other than MP3, WMA, and AAC files not included)	
File name and folder name restrictions	Maximum 64 bytes (for Unicode, 32 characters), files/ folders with file/ folder names longer than this will not be displayed or played back.	
USB supported formats	The recommended file system is FAT32. 1 partition only	

*¹. Do not include other than MP3/WMA/AAC files. However, if storing many tracks within the same folder, these may not be recognized even if less than the maximum number of tracks. In these cases, divide the tracks up into multiple folders.

 **NOTE**

- The order in which folders and audio files are displayed on this product may be different to how they are displayed on a computer.

What Is MP3?

N00715900020

MP3 is an abbreviation of “MPEG-1 Audio Layer 3”. MPEG is an abbreviation of “Motion Picture Experts Group”, and this is a video compression standard used in video CDs, etc.

MP3 is one of the audio compression methods contained in the MPEG audio standard, and reduces the quality of sounds that are beyond the auditory resolution of the human ear and that are hidden by louder sounds, thus creating high-quality data with a lower data size.

Because this can compress CD audio to approximately 1/10 its original data size without perceptible loss, approximately 10 CDs can be written to a single CD-R/RW disc.

CAUTION

- MP3 files different to the standards at right may not play back correctly, or file/folder names may not be displayed correctly.

Standards for MP3 Files That Can Be Played Back

Specifications for MP3 files that can be played are as below.

Item	Details
Specification	MPEG-1 AUDIO LAYER3
	MPEG-2 AUDIO LAYER3
Sampling frequency [kHz]	MPEG-1: 32/44.1/48
	MPEG-2: 16/22.05/24
Bit rate [kbps]	MPEG-1: 32 to 320
	MPEG-2: 8 to 160
VBR (variable bit rate)	Support
Channel mode	Stereo/ Joint stereo/ Dual channel/ Monaural
File extension	mp3
Supported tag information	ID3 tag Ver. 1.0, Ver. 1.1, Ver. 2.2, Ver. 2.3, Ver. 2.4 (ISO-8859-1, UTF-16 (Unicode)), Titles, Artist name, Album name
Maximum number of characters that can be indicated on the display	64 characters

Audio Files (MP3/WMA/AAC)

What Is WMA?

N00716000028

WMA is an abbreviation of Windows Media Audio, and this is an audio compression format from Microsoft. This is a compression format that has a higher compression ratio than MP3.

NOTE

- Microsoft, Windows Media, and Windows are registered trademarks of Microsoft Corporation (USA) and in other countries.

CAUTION

- WMA supports digital rights management (DRM). This product cannot play back WMA files protected using this system.
- WMA files different to the standards at right may not play back correctly, or file/folder names may not be displayed correctly.
- “Pro”, “Lossless”, and “Voice” are not supported.

Standards for WMA Files That Can Be Played Back

Specifications for WMA files that can be played are as below.

Item	Details
Specification	Windows Media Audio Version7.0/8.0/9.0
Sampling frequency [kHz]	32/44.1/48
Bit rate [kbps]	48 to 320
VBR (variable bit rate)	Support
Channel mode	Stereo/Monaural
File extension	wma
Supported tag information	WMA tags Title name, Artist name, Album name
Maximum number of characters that can be indicated on the display	64 characters

What Is AAC?

N00716100029

AAC is an abbreviation of Advanced Audio Coding, and this is an audio compression standard used in “MPEG-2” and “MPEG-4”. This features 1.4x the compression of MP3, with comparable audio quality.

CAUTION

- AAC supports digital rights management (DRM). This product cannot play back AAC files protected using this system.
- AAC files different to the standards at right may not play back correctly, or file/folder names may not be displayed correctly.

Standards for AAC Files That Can Be Played Back

7

Specifications for AAC files that can be played are as below.

Item	Details	
Specification	Advanced Audio Coding MPEG4/AAC-LC MPEG2/AAC-LC	
Sampling frequency [kHz]	MPEG4	8/11.025/12/16/22.05/24/32/44.1/48
	MPEG2	8/11.025/12/16/22.05/24/32/44.1/48
Bit rate [kbps]	MPEG4	8 to 320
	MPEG2	8 to 320
VBR (variable bit rate)	Support	
Channel mode	Stereo/Monaural	

Important Points on Safety for the Customer

Item	Details
File extension	m4a
Supported tag information	AAC tags or ID3 tags Title, Artist name, Album name
Maximum number of characters that can be indicated on the display	64 characters

7

Important Points on Safety for the Customer

N00716200020

This product features a number of pictorial indications as well as points concerning handling so that you can use the product correctly and in a safe manner, as well as prevent injury or damage to yourself, other users, or property.

⚠ WARNING

- The driver should not pay close attention to the display while driving. This may prevent the driver looking where they are going, and cause an accident.

⚠ WARNING

- The driver should not perform complicated operations while driving. Performing complicated operations while driving may prevent the driver looking where they are going, and cause an accident. Therefore stop the vehicle in a safe location before performing such operations.
- Do not use during malfunctions, such as when no sound is audible. This may lead to accident, fire, or electric shock.
- Ensure water or other foreign objects do not enter the product. This may lead to smoking, fire, electric shock, or malfunction.
- Do not insert foreign objects into the disc slot. This may lead to fire, electric shock, or malfunction.
- In the event of abnormalities occurring when foreign objects or water enter the product, resulting in smoke or a strange smell, immediately stop using the product, and consult an authorized Mitsubishi Motors dealer or a repair facility of your choice. Continuing to use the product may result in accident, fire, or electric shock.
- Do not disassemble or modify the product. This may lead to malfunction, fire, or electric shock.

⚠ WARNING

- During thunderstorms, do not touch the antenna or the front panel. This may lead to electrical shock from lightning.

⚠ CAUTION

- Do not block ventilation holes or heat sinks on the product. Blocking ventilation holes or heat sinks may prevent heat from escaping from within the product, leading to fire or malfunction.
- Do not turn the volume up to the extent that you cannot hear sounds from outside the vehicle while driving. Driving without being able to hear sounds from outside the vehicle may result in an accident.
- Do not insert your hand or fingers into the disc slot. This may result in injury.

Operation Keys

N00716300021

Turn the Power ON/ OFF

N00716400022

1. Press the PWR/VOL key.

Operation Keys

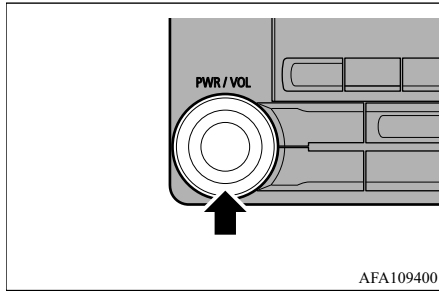

- Turn the power on, and resume playback from the previous status.
2. Press the PWR/VOL key.
Turn the power OFF.

NOTE

- Hold down the steering MODE key to also turn the audio function ON/OFF.

Adjust Volume

N00716500023

1. Turn the PWR/VOL key to adjust the volume.

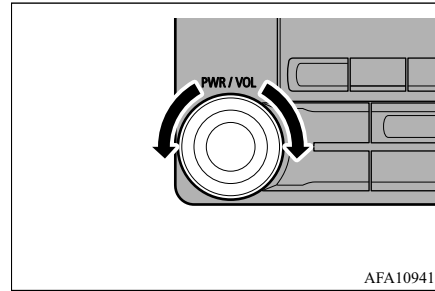

- Turn the PWR/VOL key clockwise to increase, and counter-clockwise to decrease the volume.

NOTE

- The maximum value for volume is 45, and the minimum is 0.
- The initial setting for volume is "17".

Insert/Eject Discs

N00716600024

1. Insert the disc into the disc slot with the label surface up.

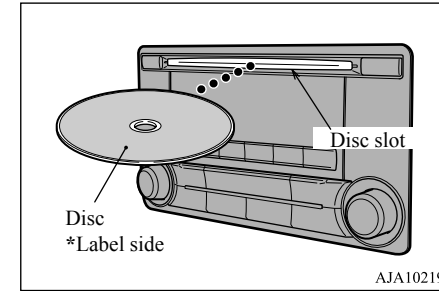

- Push the disc in a certain amount, and the product will pull the disc in, and playback will start.

2. Press the  key.

This will eject the disc from the product, so remove the disc.

CAUTION

- When replacing discs, first ensure that the vehicle is stopped in an area in which stopping is permitted.
- Do not insert your hand, fingers, or foreign objects into the disc slot. This may lead to injury, smoking, or fire.
- 3 inches (8 cm) CDs are not supported.

Operation Keys

Explanation of Buttons

N00716700025

This explains names and functions of each part.

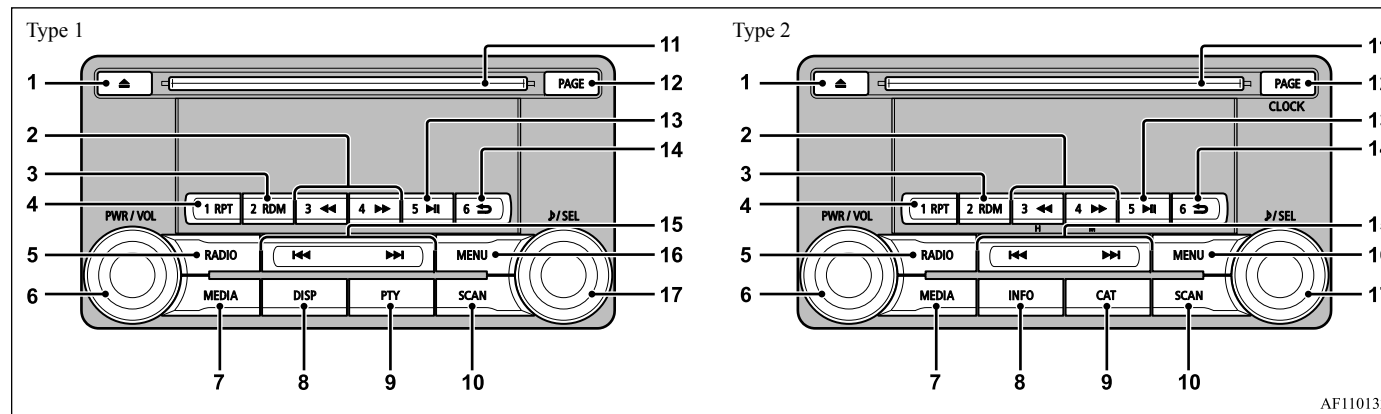

AF1101327

1- ▲ key
Use to eject a disc.

2- 3 ◀◀ key/4 ▶▶ key
For audio, rewind/fast forward.
For radio, use as preset keys 3 and 4.

3- 2RDM key
For audio, play random playback; for radio, use as preset key 2.

4- 1RPT key
For audio, play repeat playback; for radio, use as preset key 1.

5- RADIO key
Switch the radio and the band.

6- PWR/VOL key
Adjust the volume, and turn the power ON/OFF.

7- MEDIA key
Switch between CD and other sources.
Hold down the key to switch to AUX.

8- DISP key (Type 1), INFO key (Type 2)
Switch the content of the display.

9- PTY key (Type 1), CAT key (Type 2)
CAT (category content) searches and scans can be performed while receiving radio RBDS broadcasts.

Search channels in the satellite radio*1.

10- SCAN key
For audio, play scan playback; for radio, scan for stations.

11- Disc slot

12- PAGE key
Display indicator page advance.

- 13- 5 **▶||** key
Play/Pause Bluetooth Audio*², and use as preset key 5 for radio.
 - 14- 6 **↶** key
Return during audio track search, and stop Bluetooth Audio*².
For radio, use as preset key 6.
 - 15- **◀◀** key/ **▶▶** key
For audio, select audio track/file; for radio, perform automatic station selection.
Select channels in the satellite radio*¹.
 - 16- MENU key
Switch to Menu mode.
 - 17- **♪/SEL** key
Adjust audio quality and select items.
For radio, manually select stations.
Select channels in the satellite radio*¹.
- *¹: Requires a satellite tuner connection.
*²: Requires a separately-purchased Bluetooth-capable audio device in equipment by type (vehicles with a Bluetooth[®] 2.0 interface).

Steering wheel audio remote control switches

N00716800039

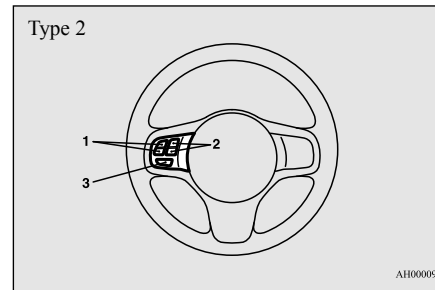
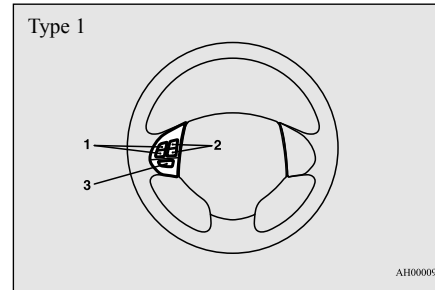

- 1- Vol + key, - key
Adjust audio functions and the mobile phone function volume.

- 2- CH **▼** key, **▲** key
Select CD and other audio source tracks and radio stations.
Hold down to skip up and down through tracks.
Hold down to switch the satellite radio band during satellite radio reception.
- 3- MODE key
Hold down to turn the audio function ON/OFF. Additionally, each time this is pressed, this switches the audio source.
The order of switching is as shown below.
If devices are not connected, then these are to be skipped, and the next source selected.

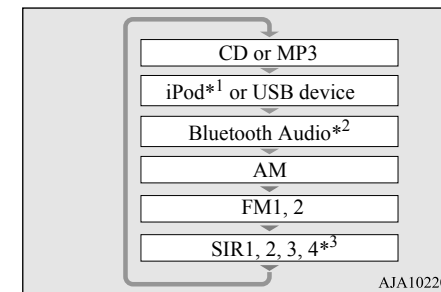

*¹: An iPod cable (available separately) is required.

Listen to Radio

- *2: Requires a separately-purchased Bluetooth-capable audio device (vehicles with a Bluetooth[®] 2.0 interface).
- *3: Requires a satellite tuner connection.

Listen to Radio

N00716900027

This explains how to listen to AM and FM radio broadcasts.

7

To Listen to the Radio

Press the RADIO key to switch the band.

Switch between AM and FM bands.
The selected band is indicated on the display.

NOTE

- Bands switch in the order AM, FM1, FM2, SIR1*, SIR2*, SIR3*, and SIR4*.
- If no signal is received, bands will not be switched to SIR2, SIR3, or SIR4.

*: When a satellite tuner is connected

Manual/Seek Station Selection

Turn the **▶/SEL** key to the frequency to listen to.

7-42 Comfort controls

▶/SEL key (counter-clockwise)	Reduces the frequency being received.
▶/SEL key (clockwise)	Increases the frequency being received.
▶▶ key (hold down)	Release the button to start seek station selection, and when a station is received, scanning stops.
 ◀◀ key (hold down)	

Scan Station Selection

Collective search for stations that can be received.

Press the SCAN key.

When a station is received, this is played for 5 seconds, then the product searches for the next station.

NOTE

- Press this button again while receiving the station to return to normal reception.

Preset Memory

Register the broadcast station in advance, and select this at a later time.

1. Tune in to the frequency to register.
2. Hold down any of the keys from the 1RPT key to the 6 **➡** key.

A “Beep” sounds, and the preset key is registered.

NOTE

- The preset memory can register a maximum of 6 stations for each band.
- If a preset key that already has a station registered is selected, then this is overwritten with the new preset.
- Pressing the preset key will select the previously registered frequency.

CAT Search

During RBDS broadcast reception, select CAT (category content), and automatically scan for stations.

1. During FM reception, press the PTY key (Type 1) or CAT key (Type 2).
This switches to the CAT selection mode.

2. Press the PTY key (Type 1) or CAT key (Type 2) to select CAT.
3. Press the ◀◀ key or ▶▶ key.
The CAT (category content) indicator will flash, and station selection will automatically start.
When a station is received, the frequency is displayed.

NOTE

- This receives the station detected first.
- 10 seconds after reception, CAT search mode will be cancelled.
- To receive a different station, press the ◀◀ key or ▶▶ key again.

CAT Scan

During RBDS broadcast reception, select CAT (category content) to perform a collective search for stations.

1. During FM reception, press the PTY key (Type 1) or CAT key (Type 2).
This switches to the CAT selection mode.
2. Press the PTY key (Type 1) or CAT key (Type 2) to select CAT.
3. Press the SCAN key.

When a broadcast station is received, this is played for 5 seconds, then the product searches for the next station.

NOTE

- Press this key again while receiving the station to return to normal reception.

Listen to Satellite Radio (if so equipped)

N0071700025

This section explains how to listen to satellite radio.

NOTE

- A subscription is required to listen to satellite radio. Satellite radio cannot be received after the free trial period has expired.
- If no subscription has been made when the free trial period expires, the display will alternate between “CALL” and “888-539-SIRI”.

To listen to Satellite Radio

Press the RADIO key to switch the band.

Listen to Satellite Radio (if so equipped)

Switches between SIR1, SIR2, SIR3, and SIR4 bands.

The selected band is indicated on the display.

NOTE

- Bands switch in the order AM, FM1, FM2, SIR1, SIR2*, SIR3*, and SIR4*.
- Switch satellite radio bands by holding down the ▼ key or ▲ key on the steering remote control switch.

*:If no signal is received, bands will not be switched.

7

Select a Station

Press the ◀◀ key or ▶▶ key to select the station.

◀◀ key	Go down one step from the channel being received.
▶▶ key	Go up one step from the channel being received.
◀◀ key (Hold down)	While the key is held down, it will cycle down through the channels being received.

Listen to Satellite Radio (if so equipped)

▶▶ key
(Hold down)

While the key is held down, it will cycle up through the channels being received.

NOTE

- When cycling up/down through channels, the channel number display in the upper level of the display changes.
- When channel number "000" is selected, the SIRIUS ID (12 digits) is displayed.

7

Scan Station Selection

Channels are received in order and take 10 seconds each.

Scan All Channels

Press the SCAN key.

All of the channels are scanned.

NOTE

- Press this key again while receiving the channel to return to normal reception.
- Selecting a channel will cancel this.

Scan Category Channels

1. Press the PTY key (Type 1) or CAT key (Type 2).
Switches to the category search mode, and the category name is indicated on the display.
2. Turn the /SEL key to select the category.
3. Press the SCAN key.

The channels in the selected category are scanned.

NOTE

- Press the SCAN key or PTY key (Type 1) or CAT key (Type 2) again while receiving the channel to return to normal reception.
- Turning the /SET key will cancel.

Preset Memory

Register the channel in advance, and select this at a later time.





1. Tune in to the channel to register.
2. Hold down any of the keys from the 1RPT key to the 6  key.
A "Beep" sounds, and the preset key is registered.

NOTE

- The preset memory can register a maximum of 6 stations per band.
- If a preset key that already has a channel registered is selected, then this is overwritten with the new preset.
- Pressing the preset key will select the previously registered channel.
The preset channels on the display are shown as "P1" though "P6".

Channel Search

Other channels can be selected while listening to a channel.

1. Press the PTY key (Type 1) or CAT key (Type 2).
Switches to the category search mode, and the category name is indicated on the display.
2. Turn the /SEL key to select the category.
3. Press the /SEL key.
Switches to channel search mode.
4. Turn the /SEL key to select the channel.
5. Press the /SEL key.

A “Beep” sounds, and the selected channel is received. (Channel preliminary setting mode)

The channel name shown on the display flashes.

Press the **♪/SEL** key again to cancel the search mode and return to normal reception.

6. To continue the search, turn the **♪/SEL** key to select the channel.
The selected channel is received.

7. Press the **♪/SEL** key.
Cancels the search mode and returns to normal reception.

NOTE

- After making preliminary settings in the channel search mode, this will switch to the channel being received.
- Channel number “000” is for the SIRUS ID display, so it cannot be searched.
- If the “PTY ALL” or “CAT ALL” category is selected, all channels can be searched in the channel search mode.
- In the category mode, press the **PTY** key (Type 1) or **CAT** key (Type 2) to cancel search mode.
- In the channel search mode, press the **6**  key to return to the category search mode.

NOTE

- In the channel preliminary setting mode, press the **6**  key to return to the category search mode without returning to the previous channel search mode.
- If there is no operation for 10 seconds, the search mode will be cancelled.

Initialize the CODE (Passcode)

The CODE required for changing the LOCK settings in the satellite settings is initialized. (The factory setting is “1111”.)

When the power is off, press the **PWR/VOL** key while holding down the **♪/SEL** key.
→ “Turn the Power ON/OFF” (P7-38)

Listen to CDs

N00717100026

This explains how to listen to audio CDs (CD-DA/CD-TEXT).

Play CDs

Insert the disc.

Insert a disc to automatically start playback.
→ “Insert/Eject Discs” (P.7-39)

Listen to CDs

If a disc is already within the product, press the **MEDIA** key to switch to CD as the source.

Select the Track

Press the **1◀◀** key or **▶▶1** key to select the track.

This enables selection of the next or previous track.

7

Fast Forward or Rewind

Hold down the **3◀◀** key or the **4▶▶** key.

Fast forward/rewind is possible.

Switch Playback Mode

Repeat playback, random playback, and scan playback are possible.

Repeat Playback (RPT)

Press the **1RPT** key.

Repeat playback of the track currently being played.

Listen to MP3s

NOTE

- Pressing again will cancel.
- Selecting a track, ejecting, fast forwarding, or rewinding will cancel.

Random Playback (RDM)

Press the 2RDM key.

7

Play the tracks on the disc in a random order.

NOTE

- Pressing again will cancel.
- Ejecting will cancel this.

Scan Playback (SCAN)

Press the SCAN key.

Play the first 10 seconds of each of the tracks on the whole disc in order.

NOTE

- Press this button again during playback if you wish to hear that track, and that track will play normally.

Listen to MP3s

N00717200027

This explains how to listen to audio files on a disc.

CAUTION

- CD-ROM and CD-R/RW media can only play back MP3 format audio files.

To Listen to MP3s



Insert the disc.

Insert a disc to automatically start playback.
→ “Insert/Eject Discs” (P.7-39)
If a disc is already within the product, press the MEDIA key to switch to CD as the source.

NOTE

- Depending on the file structure, it may take some time to read the contents of the disc.

Select the Track (File)

Press the  key or  key to select the track.

This enables selection of the next or previous track.

Fast Forward or Rewind

Hold down the 3  key or the 4  key.

Fast forward/rewind is possible.

Switch Playback Mode

Repeat playback, random playback, and scan playback are possible.

Repeat Playback (RPT)

Press the 1RPT key.

Repeat playback of the track currently being played.

NOTE

- Pressing again will cancel.
- Selecting a file, ejecting, fast forwarding, or rewinding will cancel.

Folder Repeat Playback

Hold down the 1RPT key.

Repeat playback of the tracks within the folder currently being played.

NOTE

- Pressing again will cancel.
- Even if the file is selected, folder repeat playback will not be cancelled.

Random Playback (RDM)

Press the 2RDM key.

Play the tracks in the folder in a random order.

NOTE

- Pressing again will cancel.

Folder Random Playback

Hold down the 2RDM key.

Play all tracks in folders on the disc in a random order.

NOTE

- Pressing again will cancel.

Scan Playback (SCAN)

Press the SCAN key.



Play the first 10 seconds of each of the tracks in the folder currently being played in order.

NOTE



- Press this button again during playback if you wish to hear that track, and that track will play normally.

Search Tracks

Search folders and files, and select a track.

1. Turn the /SEL key to select the folder.
2. Press the /SEL key.

Files within the selected folder are displayed.



3. Turn the /SEL key to select the file.
4. Press the /SEL key.

This plays the selected file (track).

NOTE

- While the folder is selected, press the 6  key to cancel track search mode.

NOTE

- If there is no operation for 10 seconds after selecting the folder, then track search mode will be cancelled.
- Select the folder, and hold down the /SEL key to start playback from the first track in that folder.
- While the file is selected, press the 6  key to return to the previous operation.
- While the file is selected, hold down the 6  key to cancel track search mode.
- If there is no operation for five seconds after selecting the file, that file is played back.
- Disc operations such as selecting a track will cancel track search mode.

7

Listen to an iPod

N00717300060

By connecting commercially-available iPod/iPhone devices to this product, you can play back tracks on these through the product.

CAUTION

- Do not leave the iPod/iPhone unattended in the vehicle.
- Never hold these devices in your hand to operate while driving, as this is dangerous.
- No indemnification for data loss resulting when the iPod/iPhone is connected to the product will be possible.

Listen to an iPod

CAUTION

- Depending on how the devices are handled, audio files being damaged or lost, therefore it is recommended that data be backed up.

NOTE

- Depending on the generation, model, or software version of the iPod/iPhone, playback on this product may not be possible. (→P.7-29) Additionally, playback as explained in this document may not be possible.
- For vehicles with a Bluetooth® 2.0 interface, the types of devices that can be connected may vary.
[For vehicles sold in U.S.A.]
For details, access the Mitsubishi Motors North America website.
[For vehicles sold in Canada and Mexico]
For details, access the Mitsubishi Motors website. Please read and agree to the “Warning about Links to the Web Sites of Other Companies”. The websites mentioned above may connect you to websites other than the Mitsubishi Motors website.
<http://www.mitsubishi-motors.com/en/products/index.html>
- Regarding how to connect the iPod/iPhone, refer to “How to connect an iPod” on page 5-182.
- When connecting the iPod/iPhone, use a commercially-available iPod connection cable.

NOTE

- Set up the device in order that no unsafe actions, such as plugging in the connection cable are taken while driving.
- When inserting and removing the iPod/iPhone, for safety’s sake first stop the vehicle.
- Depending on the status of the iPod/iPhone, it may take some time until the device is recognized, or playback starts.
- Buttons on the product will not operate while iPod/iPhone is connected.
- iPod/iPhone specifications and settings may mean that connection is not possible, or result in differences in operation or display.
- Depending on audio data in the iPod/iPhone, track information may not be displayed correctly.
- Depending on the status of the vehicle and device, the iPod/iPhone may not play back after starting the engine.
- Data containing copyright information may not play back.
- It is recommended that the iPod/iPhone equalizer settings be set to flat.
- Operate the iPod/iPhone while connected to this product.
- If the iPod/iPhone is connected via Bluetooth as a Bluetooth-capable audio device, then do not connect the iPod/iPhone using an iPod cable. Connection using both methods will result in erroneous operation.

NOTE

- If an iPod/iPhone does not operate correctly, then remove the iPod/iPhone from the product, reset, then reconnect.

Play iPod

Press the MEDIA key to set the iPod as the source.

The selected source is indicated on the display.

Select the Track (File)

Press the ◀◀ key or ▶▶ key to select the track.

This enables selection of the next or previous track.

Fast Forward or Rewind

Hold down the 3 ◀◀ key or the 4 ▶▶ key.

Fast forward/rewind is possible.

Switch Playback Mode

Repeat playback and shuffle playback are possible.

Repeat Playback (RPT)

Press the 1RPT key.

Repeat playback of the track currently being played.

NOTE

- Pressing again will cancel.

Shuffle Playback (RDM)

Press the 2RDM key.

Play tracks in the category currently being played in a random order.

NOTE

- Pressing again will cancel.

Album Shuffle Playback

Hold down the 2RDM key.

Play back the album in a random order (tracks in any order on the album).

NOTE

- Pressing again will cancel.

Search Tracks

Search categories or track names, and select a track.

1. Turn the **▶/SEL** key to select the category.
2. Press the **▶/SEL** key. Categories or tracks within the selected category are displayed.
3. Turn the **▶/SEL** key to select the category or track.
4. Press the **▶/SEL** key.
Repeat steps 1 to 4, and search for tracks.
Select the track, and press the **▶/SEL** key to play.

NOTE

- While the category (1st level) is selected, press the **6 ➡** key to cancel track search mode.

Listen to Audio Files on a USB Device

NOTE

- If there is no operation for 10 seconds after selecting the category, then track search mode will be cancelled.
- Select the category, and hold down the **▶/SEL** key to start playback from the first track in that category.
- While the track is selected, press the **6 ➡** key to return to the previous operation.
- While the track is selected, hold down the **6 ➡** key to cancel track search mode.
- If there is no operation for five seconds after selecting the track, that file is played back.
- iPod operations such as selecting a track will cancel track search mode.

7

Listen to Audio Files on a USB Device

N00717400074

By connecting commercially-available USB devices such as USB memory to this product, you can play back audio files on these through the product.

CAUTION

- Do not leave the USB device unattended in the vehicle.
- Never hold these devices in your hand to operate while driving, as this is dangerous.

Listen to Audio Files on a USB Device

7

CAUTION

- Do not use hard discs, card readers, or memory readers, as damage may occur to these or to the data contained therein. If these are erroneously connected, then turn the ignition switch to the “LOCK” position, then remove.
- Because of the risk of data loss, it is recommended that files be backed up.
- No guarantee is made as regards damage to the USB device, nor regarding loss or damage to data contained therein.
- Depending on how the devices are handled, audio files being damaged or lost, therefore it is recommended that data be backed up.

NOTE

- Digital audio players that support the mass storage class specifications can be connected.
- For details regarding the types of USB devices that can be connected and the types of files that can be played back in vehicles with a Bluetooth® 2.0 interface, refer to “Types of connectable devices and supported file specifications” on page 5-182.
- Regarding how to connect USB devices, refer to “How to connect a USB memory device” on page 5-181.
- When connecting a USB device, use a connection cable. Failure to use a connection cable when connecting may place undue load on, or damage the USB connector.

NOTE

- Set up the device in order that no unsafe actions, such as plugging in the connection cable are taken while driving.
- When inserting and removing the USB device, for safety’s sake first stop the vehicle.
- Do not insert other than audio devices into the USB port. Damage to the device or equipment may result.
- Depending on the status of the USB device, it may take some time until the device is recognized, or playback starts.
- Depending on USB devices, buttons on the product will not operate while the USB device is connected.
- USB device specifications and settings may mean that connection is not possible, or result in differences in operation or display.
- Depending on audio data in the USB device, track information may not be displayed correctly.
- Depending on the status of the vehicle and device, the iPod/iPhone may not play back after starting the engine.
- Data containing copyright information may not play back.
- This product can play back MP3, WMA, and AAC format audio files.
- Depending on the type of USB device, usage may not be possible, or functions that can be used may be restricted.
- The recommended file system for USB memory is FAT32.

NOTE

- The maximum supported capacity for USB memory is 32GB.
- Operate the USB device containing recorded audio files while connected to this product.

Play Back of Audio Files on a USB Device

Press the MEDIA key to set USB as the source.

The selected source is indicated on the display.

Select the Track (File)

Press the ◀◀ key or ▶▶ key to select the track.

This enables selection of the next or previous track.

Fast Forward or Rewind

Hold down the 3 ◀◀ key or the 4 ▶▶ key.

Fast forward/rewind is possible.

Switch Playback Mode

Repeat playback, random playback, and scan playback are possible.

Repeat Playback (RPT)

Press the 1RPT key.

Repeat playback of the track currently being played.

NOTE

- Pressing again will cancel.
- Selecting a file will cancel this.
However, it will not be cancelled in vehicles with a Bluetooth® 2.0 interface.

Folder Repeat Playback

Hold down the 1RPT key.

Repeat playback of the tracks within the folder currently being played.

NOTE

- Pressing again will cancel.
- Selecting a folder will cancel this.

NOTE

- Cycling up/down through files will cancel this.
- Even if the file is selected, folder repeat playback will not be cancelled.

Folder Random Playback (RDM)

Press the 2RDM key.

Play tracks in the folder currently being played in a random order.

NOTE

- Pressing again will cancel.
- Selecting a folder will cancel this.
- Cycling up/down through files will cancel this.
- Even if the file is selected, folder random playback will not be cancelled.

All Folder Random Playback

Hold down the 2RDM key.

Play the tracks in all folders in a random order.

NOTE

- Pressing again will cancel.

Listen to Audio Files on a USB Device

NOTE

- Selecting a folder will cancel this.
- Cycling up/down through files will cancel this.
- Even if the file is selected, all folder random playback will not be cancelled.

Scan Playback (SCAN)

Press the SCAN key.

Play the first 10 seconds of each of the tracks on the whole USB device in order.

NOTE

- Press this button again during playback if you wish to hear that track, and that track will play normally.

Folder Scan Playback

Hold down the SCAN key.

Play the first 10 seconds of the first track in each folder on the USB device in order.

NOTE

- Press this button again during playback if you wish to hear that track, and that track will play normally.

Listen to Bluetooth Audio (if so equipped)

Search Tracks

Search folders and files, and select a track.

1. Turn the **▶/SEL** key to select the folder.
2. Press the **▶/SEL** key.



Files within the selected folder are displayed.

3. Turn the **▶/SEL** key to select the file.
4. Press the **▶/SEL** key.

7

This plays the selected file (track).

NOTE

- While the folder is selected, press the **6**  key to cancel track search mode.
- If there is no operation for 10 seconds after selecting the folder, then track search mode will be cancelled.
- Select the folder, and hold down the **▶/SEL** key to start playback from the first track in that folder.
- While the file is selected, press the **6**  key to return to the previous operation.
- While the file is selected, hold down the **6**  key to cancel track search mode.
- If there is no operation for five seconds after selecting the file, that file is played back.
- Operations such as selecting a track will cancel track search mode.

7-52 Comfort controls

Listen to Bluetooth Audio (if so equipped)

N00717500020

This product can play back tracks on commercially-available Bluetooth-capable audio devices.

CAUTION

- Never hold these devices in your hand to operate while driving, as this is dangerous.
- Do not leave the Bluetooth audio device unattended in the vehicle.
- Depending on how the devices are handled, audio files being damaged or lost, therefore it is recommended that data be backed up.

NOTE

- Depending on the type of Bluetooth-capable audio devices, usage may not be possible, or functions that can be used may be restricted.
- Confirm together with the user manuals for the commercially-available Bluetooth-capable audio devices.
- Depending on the type of Bluetooth-capable audio devices, volume levels may differ. There is the danger of loud volumes, so prior to use, it is recommended that you turn the volume down.
→ “Adjust Volume” (P.7-39)

NOTE

- Depending on the status of the Bluetooth audio device, it may take some time until the device is recognized, or playback starts.
- Bluetooth audio device specifications and settings may mean that connection is not possible, or result in differences in operation or display.
- Depending on audio data in the Bluetooth audio device, track information may not be displayed correctly.
- Depending on the status of the vehicle and device, the iPod/iPhone may not play back after starting the engine.

Connect a Bluetooth-capable Audio Device

Regarding how to connect your Bluetooth device, refer to “Connecting the Bluetooth® 2.0 interface and Bluetooth device” on page 5-166.

Operation methods below describe situations once connection has been completed.

NOTE

- If the iPod/iPhone is connected via Bluetooth as a Bluetooth-capable audio device, then do not connect the iPod/iPhone using an iPod cable. Connection using both methods will result in erroneous operation.

Use AUX (if so equipped)



Play Bluetooth Audio

1. Press the MEDIA key to set Bluetooth Audio as the source.



The selected source is indicated on the display.

2. Press the 5  key. Bluetooth Audio playback starts.

NOTE

- Hold down the 5  key to pause.
- Press the 6  key to stop.

Select the Track (File)

Press the 1  key or 2  key to select the track.

This enables selection of the next or previous track.

Fast Forward or Rewind

Hold down the 3  key or the 4  key.

Fast forward/rewind is possible.

Switch Playback Mode

Repeat playback, random playback, and scan playback are possible.

Repeat Playback (RPT)

Press the 1RPT key.

Repeat playback of the track currently being played.

NOTE

- Each time the 1RPT key is pressed, this switches in the order Repeat OFF, 1 track repeat, All track repeat, and Repeat OFF.

Random Playback (RDM)

Press the 2RDM key.

Play the tracks in the Bluetooth Audio device in a random order.

NOTE

- Pressing again will cancel.

Scan Playback (SCAN)

Press the SCAN key.

Play the first 10 seconds of each of the tracks on the whole Bluetooth Audio device in order.

NOTE

- Press this button again during playback if you wish to hear that track, and that track will play normally.

7

Use AUX (if so equipped)

N0071760034

By connecting external input cables and AUX devices to this product, you can play back tracks on these devices through the product.

Hold down the MEDIA key. Switch to the AUX mode, and "AUX" is displayed.

Use AUX (if so equipped)

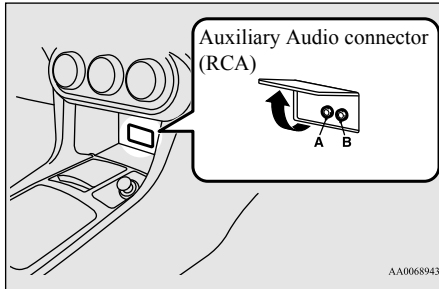

7

Auxiliary Audio connector (RCA)

- A- Left audio input connector (white)
- B- Right audio input connector (red)

CAUTION

- Connect an audio device with external sound input mode canceled, or with the sound turned down.
- Even if not inserted, the product will switch to AUX, therefore take care with volume levels when not inserted.

NOTE

- Depending on the audio device to be connected, noise may be emitted.
- For power, use the battery power source included in the audio device to be connected. Using the connected audio device while charging through the cigarette lighter socket in the vehicle may lead to noise being emitted through the speakers.

NOTE

- If no audio devices are connected, then do not select the external sound input mode. If external sound input mode is selected while no audio devices are connected, then sound may be emitted through the speakers.

Display Indicator

N0071770022

This explains content of the display indicator.

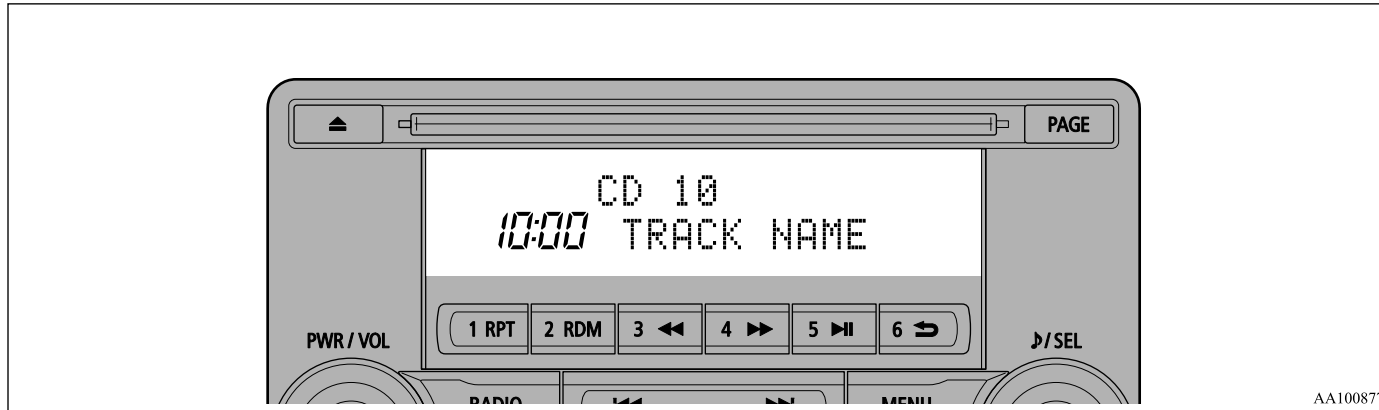

Change the Display Mode

N0071780023

You can change the content of the display indicator.

Press the DISP key (Type 1) or INFO key (Type 2) to switch the display content.

Each time the DISP key (Type 1) or INFO key (Type 2) is pressed, the display content changes.

CAUTION

- The operation of changing display contents may impede safe driving, therefore check safety before operation.

NOTE

- Up to 11 characters may be displayed at one time. To display 12 or more characters, press the PAGE key, and subsequent characters will be displayed.

During FM Reception

This switches in the order “Frequency”, “Station name”, and “Radio text”.

NOTE

- Radio text has a maximum display of 64 characters.
- If there is no text information to display, then “NO MESSAGE” is displayed.



Audio Quality and Volume Balance Adjustment

During Satellite Radio Reception

(if so equipped)

This switches in the order “Channel name”, “Category name”, “Artist name”, “Track name”, and “Composer name”.

NOTE

- The channel and category have a maximum display of 8 characters. The other items have a maximum display of 36 characters.

7

During CD-DA playback

This switches in the order “Disc title”, “Track title”, and “Operating status”.

NOTE

- If there is no text information to display, then “NO TITLE” is displayed.

During MP3/WMA/AAC Playback

This switches in the order “Folder title”, “File title”, and “Operating status”.

NOTE

- If there is no text information to display, then “NO TITLE” is displayed.

Display the ID3tag

Hold down the DISP key (Type 1) or INFO key (Type 2).

This switches the ID3tag display.

Each time DISP key (Type 1) or INFO key (Type 2) is pressed, this switches in the order “Album name”, “Track name”, “Artist name”, “Genre name”*, and “Operating status”.

*:Displayed when playing back audio files on a USB device (vehicles with a Bluetooth® 2.0 interface).

NOTE

- During display of the ID3tag, hold down the DISP key (Type 1) or INFO key (Type 2) to switch to the folder title display.
- The genre name display may not be possible.

During iPod Playback

N00718200024

This switches in the order “Albums”, “Track name”, “Artist name”, “Genre name”, and “Operating status”.

NOTE

- If there is no text information to display, then “NO TITLE” is displayed.
- Displayed genre name in equipment by type (vehicles with a Bluetooth® 2.0 interface).
- The genre name display may not be possible.

During Bluetooth® 2.0 Audio Playback (if so equipped)

N00718300025

Operating details are the same as in “During iPod Playback” (P.7-56).

Audio Quality and Volume Balance Adjustment

N00718400026

Change audio quality settings.



7

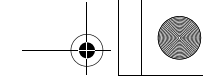
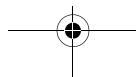

Adjust Audio Quality and Volume Balance

1. Press the **▶**/SEL key to select settings items.

Each time the **▶**/SEL key is pressed, this switches in the order BASS, TREBLE, FADER, BALANCE, SCV, and Cancel.

2. Turn the **▶**/SEL key to adjust.

Adjustment items	Turn counter-clockwise	Turn clockwise
BASS	-6 to 0 (low low-pass volume)	0 to +6 (high low-pass volume)
TREBLE	-6 to 0 (Low high-pass volume)	0 to +6 (High high-pass volume)
FADER	CENTER to REAR 11 (emphasize REAR)	FRONT 11 to CENTER (emphasize FRONT)
BALANCE	LEFT 11 to CENTER (emphasize LEFT)	CENTER to RIGHT 11 (emphasize RIGHT)

Adjustment items	Turn counter-clockwise	Turn clockwise
SCV	OFF, LOW (Low vehicle compensated volume effect)	MID, HIGH (High vehicle compensated volume effect)

System Settings

N00718500030

Change system settings such as product time.

1. Press the MENU key.
2. Press the **▶**/SEL key to select settings items.

Each time the **▶**/SEL key is pressed, this switches in the order Satellite radio settings*¹, Gracenote DB*², PHONE settings, Adjust time, and Cancel.

3. Turn the **▶**/SEL key to set.
4. Press the **▶**/SEL key to determine.

This completes settings, and displays the next settings item.

*1: Displayed when a satellite tuner is connected.

*2: Displayed when playing back audio files (vehicles with a Bluetooth[®] 2.0 interface).

System Settings

Satellite Radio Settings (if so equipped)

Change each satellite radio setting.

Settings name	Settings item	Settings value	Settings content
SIRIUS ID	—	—	This displays the SIRIUS ID.
SKIP SETTING	SKIP SETTING SELECT CH*1	ON	SKIP can be set for each channel. Channels for which SKIP is set are excluded from the search during up/down channel selecting and scanning. They can be received when selecting channels using the preset keys or searching for a station.
		OFF	
	SKIP SETTING ALL RESET	—	When “YES” is selected, the SKIP settings for all channels are turned off.
LOCK SETTING	LOCK SETTING SELECT CH*2	ON	LOCK can be set for each channel. Channels for which LOCK is set are excluded from the search during up/down channel selecting and scanning. If a channel for which LOCK is set is selected when selecting channels using the preset keys or searching for a station, “CH LCKED” is displayed within about 2 seconds after the channel text is displayed. The sound is muted.
		OFF	
	LOCK SETTING ALL RESET	—	When “YES” is selected and the CODE for settings is input, the LOCK settings for all channels are turned off.
	LOCK SETTING EDIT CODE	—	The CODE required for the LOCK settings is changed. (The factory setting is “1111”.) If the input code is incorrect, “LOCK SETTING WRG LC” is displayed.

*1: Each time the **▶**/SET key is pressed, this switches in the order Settings channel select, Change SKIP settings, and Complete settings.
To return to “each channel SKIP setting”, press the **6** **➡** key.

*2: Once the CODE (passcode) of your choice is entered, each time the **▶/SEL** key is pressed, this switches in the order Settings channel select, Change LOCK settings, and Complete settings.

To return to “each channel LOCK setting”, press the **6 ➡** key. Input the CODE from the 1 RPT key to the **6 ➡** key.

Time Setting

Set the time manually.

Type 1

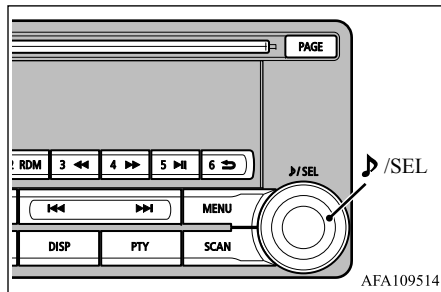

1. Select “YES” at the “Adjust time” screen, and press the **▶/SEL** key.

The hour can be adjusted. Press the **▶/SEL** key again to adjust the minutes.

2. Turn the **▶/SEL** key to adjust the time.
3. Press the **▶/SEL** key.

This completes the adjustment.

NOTE

- In order to finish adjusting the time, hold down the **▶/SEL** key until the seconds are reset to “00”.

Type 2

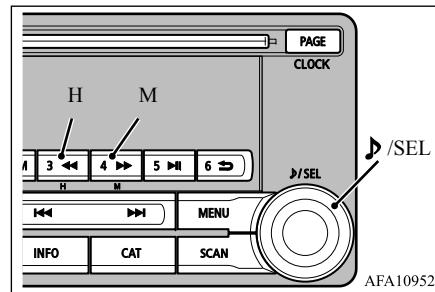

1. Select “YES” at the “Adjust time” screen, and press the **▶/SEL** key.
2. Press the various keys to adjust.

H - “Hour” setting
Press this key to fast-forward the “hours”.

- M - “Minutes” setting
Press this key to fast-forward the “minutes”.
3. Press the **▶/SEL** key.
This completes the adjustment.

NOTE

- In order to finish adjusting the time, hold down the **▶/SEL** key until the seconds are reset to “00”.
- The time can also be set using another procedure. Refer to “CLOCK” on page 7-64.

7

PHONE Settings

Change the mobile phone voice cut-in settings and the Bluetooth® 2.0 interface language.

Depending on the vehicle, PHONE settings may not be possible.

NOTE

- Cancel functions such as the mobile phone “dial lock”, and connect while on the standby screen.

System Settings

7

NOTE

- While connected, mobile phone (receiving calls, etc.) operations may not function correctly.
- Depending on the distance between the product and the mobile phone, the conditions within the vehicle, and types of screening, connection may not be possible. In these cases, situate the mobile phone as close as possible to the product.
- Even though a Bluetooth-capable mobile phone, characteristics and specifications may mean that correct operation may not be possible.
- For safety's sake, do not operate the mobile phone while driving. When operating the mobile phone, first stop the vehicle in a safe location.
- Even though a Bluetooth-capable mobile phone, phone specifications and settings may result in differences in display, or prevent correct operation.
- Some models may not be confirmed as connected, or may not connect.

Supported profiles

Hands-free	HFP(v1.5)
Phonebook transfer	OPP(v1.1), PBAP(v1.0)

Vehicles without a Bluetooth® 2.0 Interface

A hands-free kit (available separately) is required.
 (“Set value” bold typeface indicates factory default settings.)

Settings value	Settings content
PHONE OFF	Do not use mobile phone voice cut-in.
PHONE MUTE	During mobile phone voice cut-in, mute the audio.
PHONE ATT	During mobile phone voice cut-in, output audio from all speakers.
PHONE IN-L	During mobile phone voice cut-in, output sound from the left front speaker.
PHONE IN-R	During mobile phone voice cut-in, output sound from the right front speaker.
PHONE IN-LR	During mobile phone voice cut-in, output sound from the left and right front speakers.

Vehicles with a Bluetooth® 2.0 Interface

(“Set value” bold typeface indicates factory default settings.)

Settings name	Settings value	Settings content
HFM voice language settings	ENG-LISH	Change the hands free module voice language.
	FRENCH	
	SPANISH	
	JAPANESE	

Gracenote DB (Vehicles with a Bluetooth® 2.0 interface)

The version number can be confirmed.

1. Select “Gracenote DB” and press the **▶/SEL** key.
2. Turn the **▶/SEL** key and select “DB Version”.
3. Press the **▶/SEL** key.
The DB Version is displayed.

Troubleshooting

N00718600031

Please check these items if a message appears on the display, or if you think something is not working properly.

If This Message Appears...

A message is displayed on this product according to the situation.

Mode	Message	Cause	Response
CD	CHECK DISC	The disc is inserted upside down.	Insert with the label side up.
		The disc has condensation on it.	Wait a while before inserting again.
	DISC ERROR	The disc is damaged.	Clean the read surface of the disc.
		The disc is dirty.	
	INTERNAL E	The drive has malfunctioned for some reason.	Check that there is no problem with the disc, and insert the disc again. If the problem persists, consult an authorized Mitsubishi Motors dealer or a repair facility of your choice.
HEAT ERROR	The temperature inside the product is high.	Remove the disc, and wait for the internal temperature to return to normal.	

7

Troubleshooting

Mode	Message	Cause	Response
USB	FILE ERROR	Files that cannot be played are selected.	Select files that can be played. → “Audio Files (MP3/WMA/AAC)” (P.7-34)
	USB BUS PWR	There is high or low electrical current or voltage.	Turn the power OFF and wait a short while. If the problem persists, consult an authorized Mitsubishi Motors dealer or a repair facility of your choice.
	LSI ERROR	There is an internal malfunction for some reason.	
	UNSUPPORTED FORMAT	Unsupported audio files have been played.	Confirm audio files that can be played. → “Audio Files (MP3/WMA/AAC)” (P.7-34)
	UNSUPPORTED DEVICE	An unsupported USB device has been connected.	Please connect a USB memory device.
iPod	NO SONG	An iPod/iPhone not containing any tracks has been connected.	Connect an iPod/iPhone containing tracks.
	VER ERROR	This iPod/iPhone software version is not supported.	Please change to a supported software version.
Other	ERROR DC	An abnormal direct voltage has been sent to the speakers.	Turn the power OFF and wait a short while. If the problem persists, consult an authorized Mitsubishi Motors dealer or a repair facility of your choice.

If You Think Something Is Not Working Properly...

Here is a list of symptoms, causes and responses if you think something is not working properly.

Symptoms	Cause	Response
There is no sound or quiet sound.	The volume is turned to its minimum.	Adjust the volume. → “Adjust Volume” (P.7-39)
	The balance or fader is turned to one side.	Adjust the balance or fader. → “Adjust Audio Quality and Volume Balance” (P.7-56)

Antenna

Symptoms	Cause	Response
The disc cannot be inserted.	A disc is already in the product.	Eject the disc. → “Insert/Eject Discs” (P.7-39)
	There is no disc in the product, but the product says it is loading.	Press the eject button once. → “Insert/Eject Discs” (P.7-39)
The disc cannot be played.	The disc is inserted upside down.	Insert with the label side up.
	The disc has condensation on it.	Wait a while before inserting.
	The disc is dirty.	Clean the read surface of the disc.
The sound skips in the same place.	The disc is damaged or dirty.	Check the disc.
There is no sound, even if the disc is inserted.	Damage to or dirt on the disc means that its data cannot be read.	Check the disc. Additionally, if using CD-R/RW discs, their characteristics may render them unable to be played.

7

Antenna

N00734200426

Roof antenna (except for vehicles with SIRIUS satellite radio)

To remove

Turn the pole (A) counterclockwise.

To install

Screw the pole (A) clockwise into the base (B) until it is securely retained.

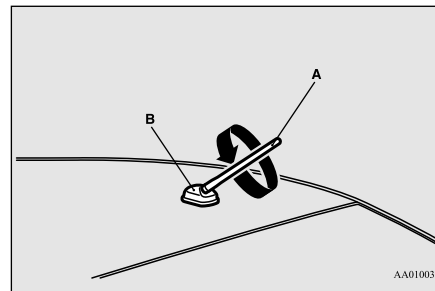

AA0100373

NOTE

- When covering your vehicle with a car cover
- When driving into a structure that has a low ceiling

Roof antenna (for vehicles with SIRIUS satellite radio)

For securing the best satellite reception, the angle of the antenna is fixed.

NOTE

- Be sure to remove the roof antenna in the following cases:
 - When using an automatic car wash

Clock (if so equipped)

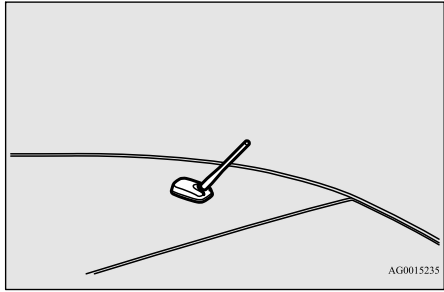

7

To remove

Turn the pole (A) counterclockwise.

To install

Screw the pole (A) clockwise into the base (B) until it is securely retained.

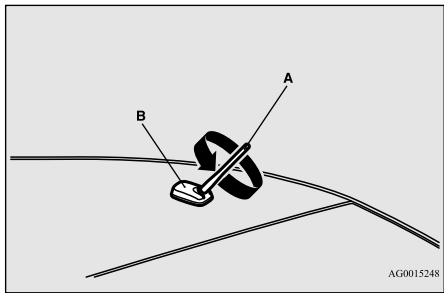

7-64 Comfort controls

NOTE

- Be sure to remove the roof antenna in the following cases:
 - When entering a place with low clearance
 - When using an automatic car wash
 - When covering your vehicle with a car cover

Clock (if so equipped)

N00755001163

The time is displayed when the ignition switch is in ON or ACC.

NOTE

- Reset the time after the battery terminals are disconnected and reconnected.

Time Setting

Type 1

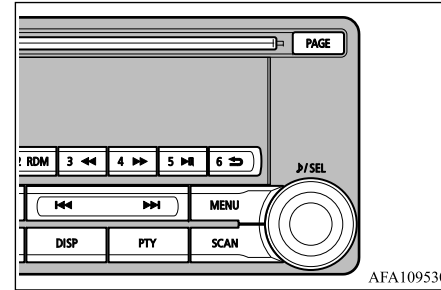

NOTE

- To set the time for the Type 1 clock, refer to "System Settings" on page 7-57.

Type 2

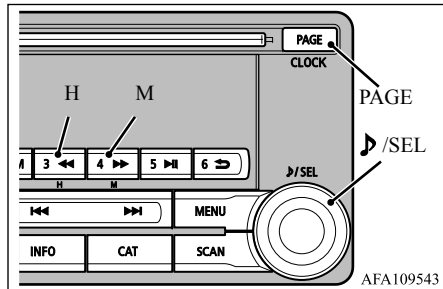

1. Press and hold the PAGE key until the clock display flashes.
2. Press the various keys to adjust.
 - H - “Hour” setting
Press this key to fast-forward the “hours”.
 - M - “Minutes” setting
Press this key to fast-forward the “minutes”.
3. Press the PAGE key to finish adjusting the time. When the adjustment is complete, the clock display stops flashing.

NOTE

- If the PAGE key is pressed and held when the time adjustment is finished, the seconds will be reset to “00”.

NOTE

- The time can also be set using another procedure. Refer to “System Settings” on page 7-57.

General information about your radio

N00733901478

Your vehicle’s radio receives both AM and FM stations.

The quality of your reception is affected by distance, obstacles, and signal interference.

This radio complies with Part 15 of Federal Communications Commission (FCC) Rules (for vehicles sold in U.S.A.). Operation is subject to the following conditions:

- The device may not cause harmful interference.
- This device must accept any interference received, including interference that may cause undesirable operation.

CAUTION

- Changes or modifications not expressly approved by the party meeting the above conditions could void the user’s authority to operate the equipment.

General information about your radio

Signal transmission

FM signals do not follow the earth surface nor are they reflected by the upper atmosphere. For this reason, FM broadcasts cannot be received over long distances. AM signals follow the earth’s surface and are reflected by the upper atmosphere. For this reason, AM broadcasts can be received over longer distances.

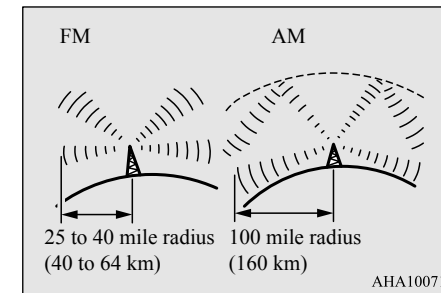

Weak reception (fading)

Because of the limited range of FM signals and the way FM waves transmit, you may experience weak or fading FM reception. When the broadcast is blocked by mountains or similar obstructions, reception can be disturbed.

General information about your radio

Reflection

The reason why one can hear FM but not AM in parking garages, under bridges etc., is that FM signals, unlike AM signals, are reflected by solid objects such as buildings, etc.

Because FM signals are easily reflected by buildings, this can also cause reception disturbances.

The direct signal from the broadcast station reaches the antenna slightly before the reflected signal. This time difference may cause some reception disturbance or flutter.

This problem occurs primarily in urban areas.

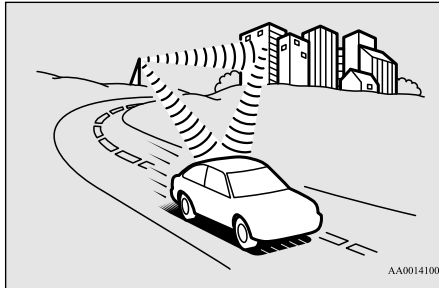

7

Cross modulation

If one listens to a weak station and is in the vicinity of another strong station, both stations might be received simultaneously.

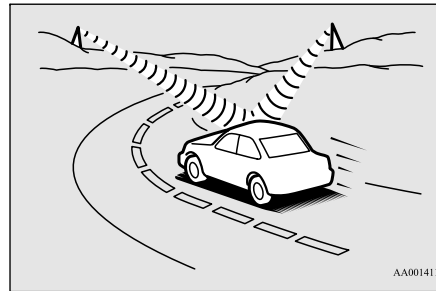

FM stereo reception

Stereo reception requires a high quality broadcast signal. This means that types of disturbances mentioned previously become more marked and the reception range is somewhat diminished during stereo reception.

Causes of disturbances

FM reception is affected by the electrical systems of vehicles in the vicinity, especially those without an electronic noise suppression

device. The disturbance is even greater if the station is weak or poorly tuned.

FM reception is not as sensitive to electrical disturbances as AM. AM reception is sensitive to electrical disturbances such as power lines, lightning and other types of similar electrical phenomena.

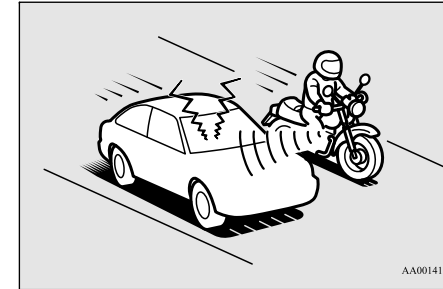

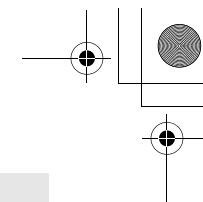

For emergencies

If the vehicle breaks down	8-2
Jump-starting the engine	8-2
Engine overheating	8-4
Tools and jack	8-5
How to change a tire	8-6
Towing	8-12
Operation under adverse driving conditions	8-14
Fuel Pump Shut-off System	8-15

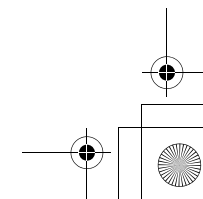
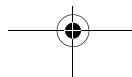
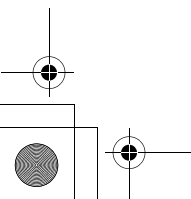
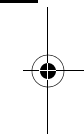
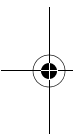



If the vehicle breaks down

If the vehicle breaks down

N00836300161

If your vehicle breaks down on the road, move to the shoulder and turn on the hazard warning flashers. If there is no shoulder, or the shoulder is not safe, drive in the right lane slowly, with the hazard lights flashing, until you come to a safe stopping place. Keep the flashers flashing.

If the engine stops/fails

8

If the engine stops, there will be no power assist to the steering and brakes, making these difficult to use.

- The brake booster will not work, so the brakes will not grip well. The brake pedal will be harder to press than usual.
- Since there is no power steering assist, the steering wheel will be hard to turn.

When the engine fails at the intersection

Get help from your passengers, bystanders, etc. to push the vehicle and move it to a safe zone.



8-2 For emergencies



Jump-starting the engine

N00836400713

If the engine cannot be started because the battery is weak or dead, you can start it with the battery from another vehicle using jumper cables.

WARNING

- When using jumper cables to start a vehicle, follow the procedures and be very cautious.

CAUTION

- Do not try to start your vehicle by pushing or towing. Vehicles with continuously variable transmission (CVT) or Twin Clutch SST cannot be started this way. Pushing or towing a vehicle that has a manual transaxle may overheat and damage the catalytic converter. Also, there is more risk of an accident when a vehicle is being pushed or towed.

1. Take off any metal jewelry such as watch bands or bracelets that might make an accidental electrical contact.
2. Position the vehicles close enough together so that the jumper cables can reach, but be sure the vehicles aren't touching each other.

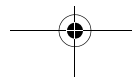

CAUTION

- Check the other vehicle. It must have a 12-volt battery. If the other system isn't 12-volt, both systems can be damaged.

3. You could be injured if the vehicles move. Set the parking brake firmly on each vehicle. Put an automatic transaxle, CVT or Twin Clutch SST in "P" (PARK) or a manual transaxle in "N" (Neutral). Turn the ignition key to the "LOCK" position.

WARNING

- Turn the ignition key to the "LOCK" position on both vehicles. Make sure that the cables or your clothes cannot be caught by the fan or drive belt. Personal injury could result.

NOTE

- Turn off all lights, heater, and other electrical loads. This will avoid sparks and help save both batteries.

4. Make sure your battery electrolyte is at the proper level. (Refer to "Checking battery electrolyte level" on page 9-15.)

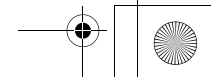
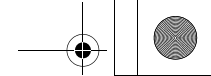

Jump-starting the engine

WARNING

- If the electrolyte fluid is not visible, or looks frozen, **DO NOT ATTEMPT JUMP STARTING!!**

The battery might split open or explode if the temperature is below the freezing point or if it is not filled to the proper level.

5. For vehicles equipped with turbocharger, remove the air duct and then the battery upper cover.

(Refer to “Removing and installing the battery upper cover” on page 9-14.)

6. Connect one end of one jumper cable to the positive (+) terminal of the discharged battery (A), and the other end to the positive (+) terminal of the booster battery (B).

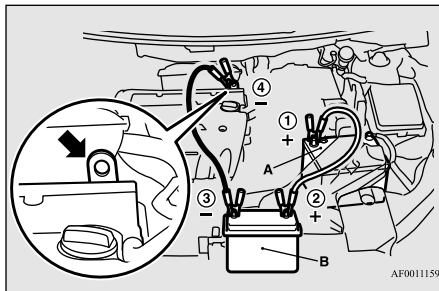
**NOTE**

- Open the terminal cover before connecting the jumper cable to the positive terminal of the battery.
(Refer to “Disconnection and connection” on page 9-16.)
- Use the proper cables suitable for the battery size.
Otherwise heat damage to the cables could result.
- Check the jumper cables for damage and corrosion before use.

7. Connect one end of the other jumper cable to the negative (-) terminal of the booster battery (B), and the other end to the engine block of the vehicle with the low battery (A) at the point farthest from the battery.

WARNING

- Be sure to follow the proper order when connecting the batteries, of:
①→②→③→④.
- Make sure that the connection ④ is made to the engine properly. If the connection is directly made to the negative side of the battery, the flammable gases from inside the battery might catch fire and explode, causing personal injury.

WARNING

- When connecting the jumper cable, do not connect the positive (+) cable to the negative (-) terminal. Otherwise sparks can make the battery explode.

CAUTION

- Make sure that the jumper cable will not be caught in the cooling fan or other moving parts in the engine compartment.

8. Start the engine in the vehicle providing the boost. Let the engine idle a few minutes, then start the engine in the vehicle with the low battery.

8**NOTE**

- If the engine is started with the air duct removed, the noise produced as air is drawn into the engine will be greater than when the duct is installed.

9. After the engine is started, disconnect the cables in the reverse order from the way you connected them.

10. For vehicles equipped with turbocharger, install the battery upper cover and then the air duct.

(Refer to “Removing and installing the battery upper cover” on page 9-14.)

Engine overheating

WARNING

- Charging your battery while it is still in your vehicle might cause the battery to catch fire and explode. If you have to charge it while in the vehicle, disconnect the negative terminal.
- Keep sparks, cigarettes and flames away from the battery because the battery may explode.
- Keep your work area well vented when charging or using the battery in an enclosed space.
- Remove all the caps before charging the battery.
- Electrolyte (battery acid) is corrosive diluted sulphuric acid. If electrolyte comes in contact with your hands, eyes, clothes, or the painted surface of your vehicle, thoroughly flush with water. If electrolyte gets in your eyes, flush them immediately and thoroughly with water, and get prompt medical attention.
- Always wear protective clothing and goggles when working near the battery.
- Keep the battery out of the reach of children.

8

As your vehicle has anti-lock brakes

If you drive your vehicle with a low battery charge, after the engine has been started by

8-4 For emergencies

using jumper cables, the engine may misfire. This can cause the anti-lock braking system warning light to blink on and off. This is only due to the low battery voltage. It is not a problem with the brake system. If this happens, fully charge the battery and ensure the charging system is operating properly.

Engine overheating

N00836500323

When the engine has overheated, the information screen in the multi-information display will be interrupted and the engine coolant temperature warning display will appear. The screen will then change to the engine coolant temperature display screen and  will flash. If this happens:

1. Stop the vehicle in a safe place. Turn on the hazard warning flashers.
2. With the engine still running, carefully raise the engine hood to vent the engine compartment.
3. Check that the cooling fan is running. If the fan is not turning, stop the engine immediately and contact an authorized Mitsubishi Motors dealer or a repair facility of your choice for assistance.

WARNING

- To avoid personal injury, keep hands, hair, jewelry and clothes away from the cooling fan. The cooling fan can start at any time.

4. If you see steam or spray coming from under the hood, turn off the engine.
5. If you do not see steam or spray coming from under the hood, leave the engine on until the bar graph for the engine coolant temperature warning display on the multi-information display goes down. When it is in the middle of the normal zone, you can start driving again. If the bar graph stays in the red zone, turn off the engine.

WARNING

- Before raising the engine hood, check to see if there is steam or spray coming from under the hood. Steam or spray coming from an overheated engine could seriously scald you.
Do not open the hood until there is no steam or spray.

6. When you do not see any more steam or spray, open the hood. Look for obvious leaks, such as a split radiator hose. Be careful as components will be hot. Any leak source must be repaired.

Tools and jack

7. If there is no obvious leak source, check the coolant level in the reserve tank. If there is none, or if it is too low, slowly add coolant.
8. If the reserve tank needs coolant, you will probably also need to add coolant to the radiator. Do not loosen or remove the radiator cap until the engine has cooled down.

⚠ WARNING

● **Removing the radiator cap could scald you with escaping hot water or steam. When checking the radiator level, cover the cap with a cloth before trying to remove it. Turn it slowly counterclockwise, without pressing down, to the first notch. The pressure in the system will then be let out. When the pressure is COMPLETELY LET OUT, press down and keep turning the cap counterclockwise until it will come off.**

9. Start the engine, and slowly add coolant, up to the bottom of the filler neck. Use plain water if you have to (and replace it with the right coolant as soon as possible).
10. Replace the radiator cap and tighten it fully. Check the engine coolant temperature display on the multi-information display. You can start driving again when the bar graph for the engine coolant temperature display returns to the normal zone.

11. Have your vehicle checked by your authorized Mitsubishi Motors dealer or a repair facility of your choice.

Tools and jack

N00836600265

Storage

The tools and jack are stowed in the trunk.

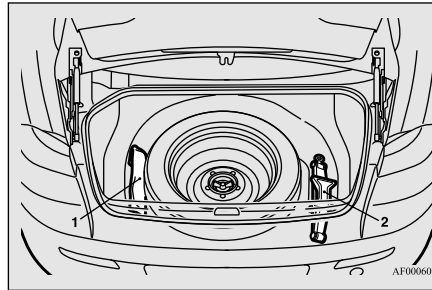

- 1- Tools
- 2- Jack

Tools

N00832600124

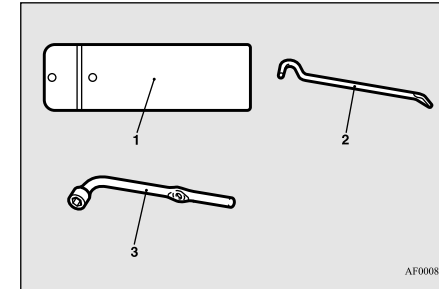

- 1- Tool bag
- 2- Bar
- 3- Wheel nut wrench

AF0008432

8

Jack

N00832700255

Before removing the jack, lift up the luggage floor board.

For front-wheel drive vehicles, pull the luggage floor board (A) rearward to release the hooks (B), and then lift it up.

How to change a tire

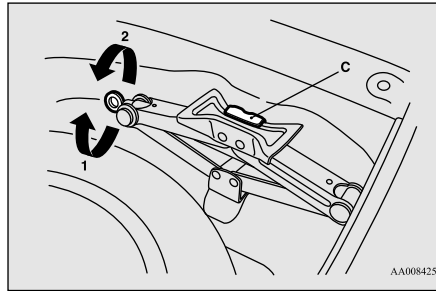
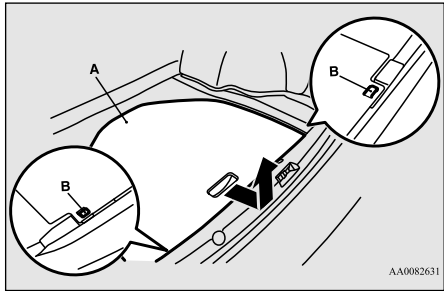

8 To remove

Turn the shaft end (1) so that the jack contracts, then remove it from the storage bracket (C).

To store

Turn the shaft end (2) by hand to expand the jack until it is held firmly in position.

How to change a tire

N00836900734

⚠ WARNING

- The jack should not be used for any purpose other than to change a tire.
- Never get under the vehicle or put any portion of your body under the vehicle while it is supported by the jack.

Before changing a tire, first stop your vehicle in a safe, flat location.

1. Park the vehicle on level and stable ground.
2. Set the parking brake firmly.
3. On vehicles with manual transaxle, turn the ignition switch to the “LOCK” position, and move the gearshift lever to the “R” (Reverse) position.

On vehicles with continuously variable transmission (CVT) or Twin Clutch SST, move the selector lever (CVT) or the gearshift lever (Twin Clutch SST) to the “P” (PARK) position, and turn the ignition switch to the “LOCK” position.

4. Turn on the hazard flashers and set up a warning triangle, flashing signal light, etc., at an adequate distance from the vehicle, and have all your passengers leave the vehicle.
5. To prevent the vehicle from rolling when it is raised on the jack, place chocks or blocks (A) at the tire that is diagonally opposite from the tire (B) you are changing.

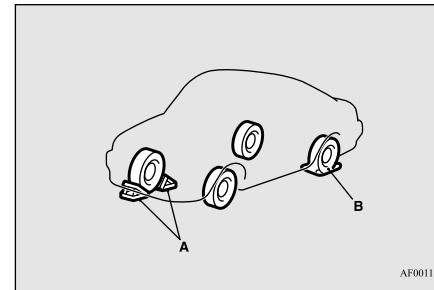

AF0011973

How to change a tire

WARNING

- Be sure to apply chocks or blocks to the correct tire when jacking up the vehicle. If the vehicle moves while jacked up, the jack could slip out of position, leading to an accident.

WARNING

- Tires, including spare tire, degrade over time with age even when they are not being used. It is recommended that tires over 6 years generally be replaced even if damage is not obvious.

CAUTION

- Do not go over 50 mph (80 km/h) when driving with the compact spare tire.
- Avoid fast starting and braking when driving with the compact spare tire.
- Do not drive through automatic car washes and over obstacles that could possibly damage the underside of your vehicle. Because the compact spare tire is smaller than the original tire, there is less clearance between the ground and your vehicle.
- Because the compact spare tire is designed only for your vehicle, do not use it on any other vehicle.
- Do not put the compact spare tire on a different wheel, and do not put standard tires, snow tires, wheel covers or trim rings on the compact spare wheel. Otherwise, you could damage these parts or other parts on your vehicle.
- Do not use snow chain with your compact spare tire. Using a chain could cause damage to your vehicle and loss of the chains.

NOTE

- The chocks shown in the illustration do not come with your vehicle. It is recommended that you purchase chocks or blocks and keep them in the vehicle for use if needed.
- If chocks or blocks are not available, use stones or any other objects that are large enough to hold the wheel in position.

CAUTION

- While the compact spare tire is stowed, the inflation pressure should be checked at least once a month to assure that it remains at the recommended inflation pressure. See the tire and loading information placard attached to the driver's door sill. Refer to "Tire and loading information placard" on page 11-3.
- Driving with an improperly inflated tire can cause an accident. If you have no choice but to drive with an under-inflated tire, keep your speed down and avoid sudden steering or braking, if possible. Inflate the tire to the correct pressure as soon as possible. Refer to "Tire inflation pressures" on page 9-21.
- The compact spare tire should be used only temporarily. While the compact spare tire is being used, the tire pressure monitoring system will not function properly. Have the tire replaced or repaired at an authorized Mitsubishi Motors dealer or a repair facility of your choice as soon as possible.
- If your vehicle has aluminum type wheels, you can use the same wheel nuts on the compact spare tire wheel.

8

6. Get the jack, bar and wheel nut wrench ready.

Refer to "Tools and jack" on page 8-5.

Spare tire information

N00849600298

Compact spare tire

The compact spare tire is designed to save space in the trunk. Its lighter weight makes it easier to use if a flat tire occurs.

To remove the compact spare tire

N00849701300

1. Lift up the luggage floor board.
For front-wheel drive vehicles, pull the luggage floor board (A) rearward to release the hooks (B), and then lift it up.

For emergencies 8-7

How to change a tire

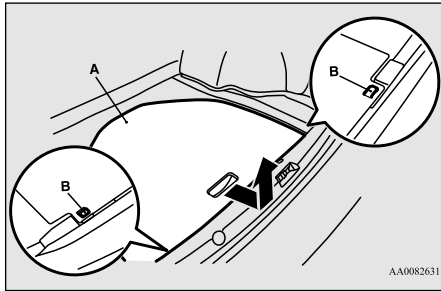

AA0082631

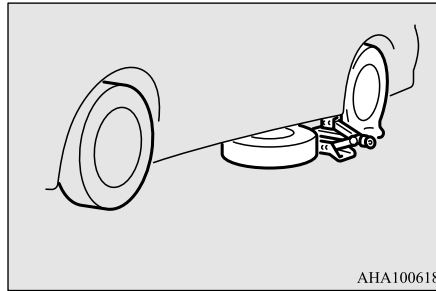

AHA100618

8

2. To remove the spare tire, remove the installation clamp (C) by turning it counterclockwise.

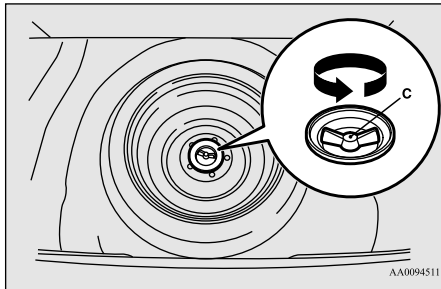

AA0094511

NOTE

- The clamp cannot be used for a normal size tire. Store a normal size tire under the luggage floor board.
- Put the spare tire under the vehicle body near the jack. This makes it safer if the jack slips out of position.

8-8 For emergencies

To change a tire

N00849800388

1. On vehicles with wheel covers, first remove the covers (refer to "Wheel covers" on page 8-11). Then loosen the wheel nuts with the wheel nut wrench. Do not remove the wheel nuts yet.

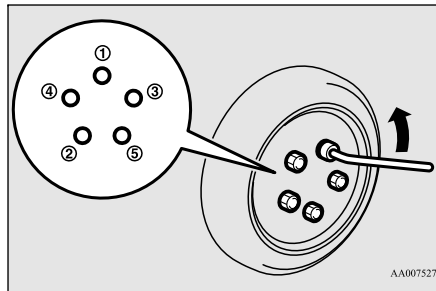

AA0075277

2. Place the jack under one of the jacking points (A) shown in the illustration. Use the jacking point closest to the tire you wish to change.

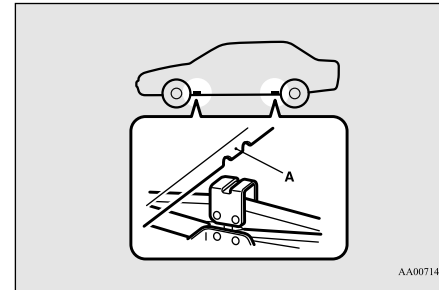

AA0071413

WARNING

- Set the jack only at the positions shown here. If the jack is set at a wrong position, it could dent your vehicle or the jack might fall over and cause personal injury.
- Do not use the jack on a tilted or soft surface. Otherwise, the jack might slip and cause personal injury. Always use the jack on a flat, hard surface. Before setting the jack, make sure there are no sand or pebbles under the jack base.

3. Rotate the jack by hand until the flange portion (B) fits in the groove (C) at the top of the jack.

How to change a tire

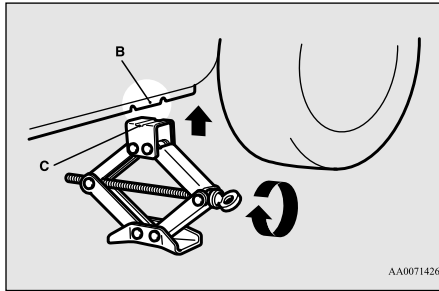

4. Insert the bar (D) into the wheel nut wrench (E). Then put the end of the bar into the shaft's jack end, as shown in the illustration. Slowly rotate the wheel nut wrench until the tire is raised slightly off the ground surface.

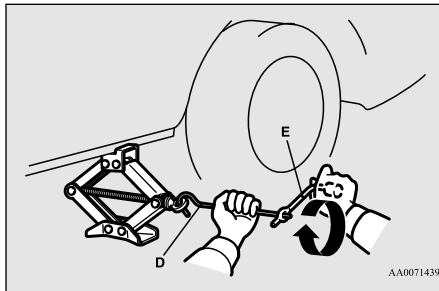

⚠ WARNING

- Stop jacking up the vehicle as soon as the tire is raised off the ground. It is dangerous to raise the vehicle any higher.
- Never get under the vehicle or put any portion of your body under the vehicle while it is supported by the jack.
- Do not bump the raised vehicle or leave it sitting on the jack for a long time. Both are very dangerous.
- Do not use a jack except the one that came with your vehicle.
- The jack should not be used for any purpose other than to change a tire.
- No one should be in your vehicle when using the jack.
- Do not start or run the engine while your vehicle is on the jack.
- Do not turn the raised wheel. The tires that are still on the ground could turn and make your vehicle fall off the jack.

5. Remove the wheel nuts with the wheel nut wrench, then take the wheel off.

⚠ CAUTION

- Handle the wheel carefully when changing the tire, to avoid scratching the wheel surface.

6. Clean out any mud, etc. on the hub surface (F), hub bolts (G) or in the installation holes (H) in the wheel, and then mount the spare tire.

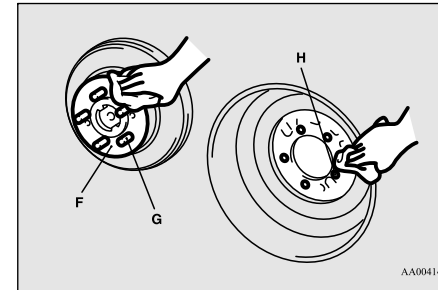

8

⚠ WARNING

- Mount the spare wheel with the valve stem (I) facing outboard. If you cannot see the valve stem (I), you have installed the wheel backwards. Operating the vehicle with the spare wheel installed backwards can cause vehicle damage and result in an accident.

How to change a tire

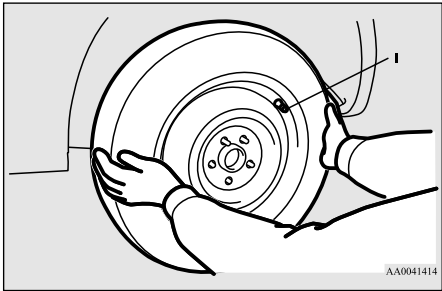

8

7. [Vehicle with steel wheels]

- Normal wheels and compact spare wheel
Install the wheel nuts (tapered nuts) with their tapered ends facing inward, then tighten by hand until the wheel is no longer loose.

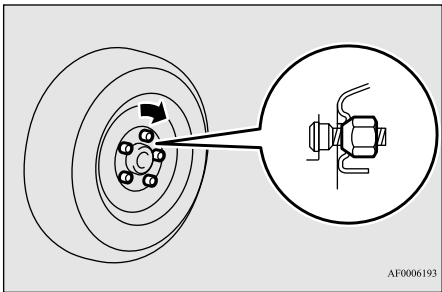

[Vehicle with aluminum wheels]

- Normal wheels

Temporarily tighten the wheel nuts (flange nuts) until their flange section comes in contact with the wheel and it is no longer loose.

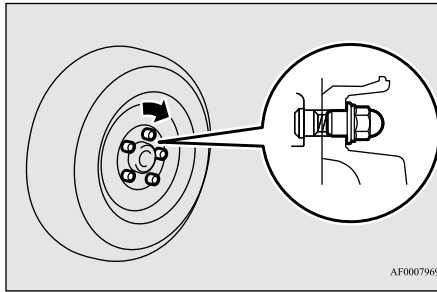

• Compact spare wheel

Install the wheel nuts with their tapered ends facing inward, then tighten by hand until the wheel is no longer loose.

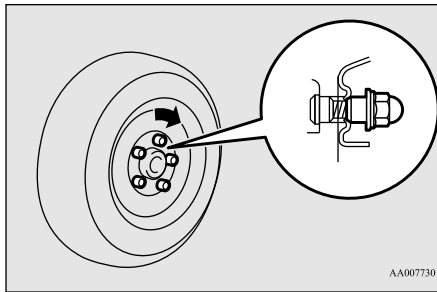

CAUTION

- Never apply oil to either the wheel bolts or the nuts or they will tighten too much.

NOTE

- Flange nuts can be temporarily used on the compact spare or steel wheel, but return them to the original wheel and tire as soon as possible.
- If all four wheels are changed to steel wheels, use tapered nuts.

8. Lower the vehicle slowly by rotating the wheel nut wrench counterclockwise until the tire touches the ground.

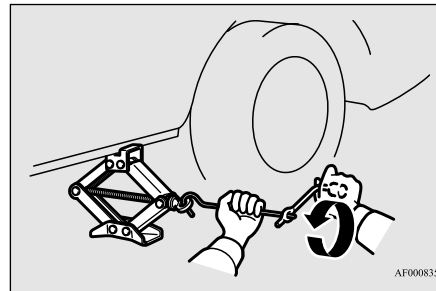

9. Tighten the nuts in the order shown in the illustration until each nut has been tightened to the torque listed here.
65 to 80 ft-lb (88 to 108 N•m)

How to change a tire

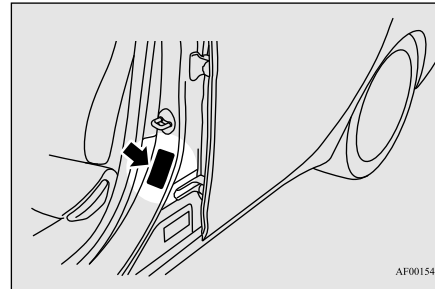
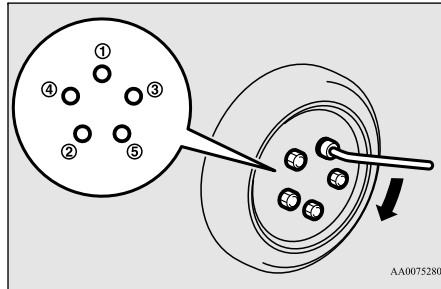

To store the flat tire or spare tire, jack, bar and wheel nut wrench

N00850000120

Reverse the removing procedure when storing the flat tire or spare tire, jack, bar and wheel nut wrench.

Refer to “To remove the compact spare tire” on page 8-7 and “Tools and jack” on page 8-5.

⚠ CAUTION

- Never use your foot or a pipe extension to apply added force to the wheel nut wrench when tightening the wheel nuts. If you do so, you can over-tighten the wheel nuts and damage the wheel, wheel nuts and hub bolts.

⚠ CAUTION

- Driving with an improperly inflated tire can cause an accident. If you have no choice but to drive with an under-inflated tire, keep your speed down and avoid sudden steering or braking, if possible. Inflate the tire to the correct pressure as soon as possible. Refer to “Tire inflation pressures” on page 9-21.
- After changing the tire and driving the vehicle about 620 miles (1,000 km), retighten the wheel nuts to make sure that they have not come loose.
- If the steering wheel vibrates when driving after changing the tire, have the tire checked for balance at your nearest authorized Mitsubishi Motors dealer or a repair facility of your choice.
- Do not mix one type of tire with another or use a different size from the one listed. This would cause early wear and poor handling.

10. Lower the jack all the way and remove it.
11. Check the tire inflation pressure. The recommended tire pressure for your vehicle is listed on the tire and loading information placard attached to the driver’s door sill as shown in the illustration. Refer to “Tire inflation pressures” on page 9-21.

Wheel covers (if so equipped)

N00849400209

8

To remove

Wrap the tip of the bar with a cloth, insert it deeply into the notch provided in the wheel cover, and pry the cover away from the wheel.

Using the same procedure at the other wheel cover notches, work the wheel cover away from the wheel to remove it completely.

Towing

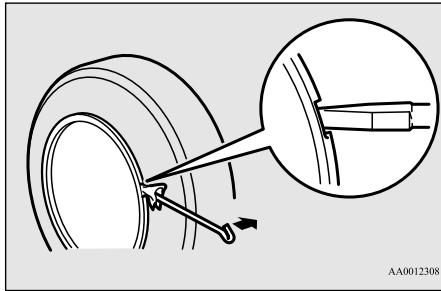

8

NOTE

- The wheel cover is made of plastic. Be careful when prying it off.

CAUTION

- Trying to remove the wheel cover with only your bare hands can seriously injure your fingers.

To install

CAUTION

- Before installing the wheel cover to the wheel, make sure that the tabs (A) on the back of the wheel cover correctly engage the ring (B) to prevent the wheel cover from coming off. Do not install a wheel cover that has broken tabs.

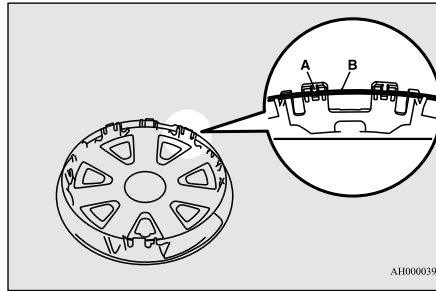

1. Align the tire air valve (C) and the wheel cover notch (D).

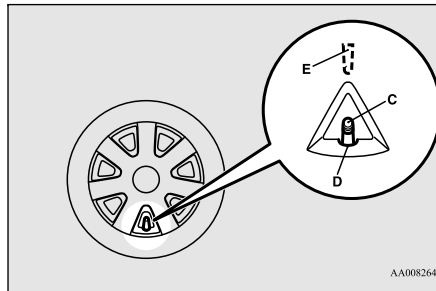

NOTE

- Full wheel covers have a symbol mark (E) provided on the reverse side to show the air valve location. Before installing the wheel cover to the wheel, make sure that the opening with the symbol mark is correctly aligned with the air valve.

2. Push the bottom (F) of the wheel cover into the wheel.
3. Gently push in both sides (G) of the wheel cover and hold them in place with both knees.
4. Gently tap the top (H) of the wheel cover. Ensure the wheel cover is securely installed around its entire outer circumference.

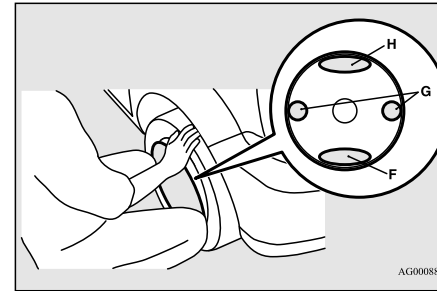

Towing

N00837001915

If your vehicle needs to be towed

If towing is necessary, we recommend you to have it done by a commercial tow truck service.

Towing

When towing is required, transport the vehicle using a tow truck.
Incorrect towing equipment could damage your vehicle.

CAUTION

- Do not attempt to be towed by another vehicle with a rope.

NOTE

- Your vehicle cannot tow any other vehicle.

There may be local regulations concerning towing in your area. Obey the regulations of the area where you are driving your vehicle.

Type A



Type B

Towing manual transaxle vehicles with rear wheels off the ground.
Do not tow continuously variable transmission (CVT) vehicles or all-wheel drive vehicles with this style.



Type C

Towing with front wheels off the ground.
Do not tow all-wheel drive vehicles with this style.



Type D



Type E



AHG100043

Towing the vehicle by a tow truck

CAUTION

- This vehicle must not be towed by a tow truck using sling lift type equipment (Type A) as illustrated. Using a sling lift will damage the bumper and front end.
- Do not tow all-wheel drive vehicles with the front or rear wheels on the ground (Type B or Type C) as illustrated. This could result in the driving system damage or vehicle may jump at the carriage.
If you tow all-wheel drive vehicles, use Type D or Type E equipment.
- Do not tow continuously variable transmission (CVT) vehicles with the driving wheels on the ground (Type B) as illustrated. If the vehicle is towed like this, the continuously variable transmission (CVT) fluid may not reach all parts of the transmission, thus damaging it.
If you tow CVT vehicles, use Type C, D or E equipment.
- If the manual transaxle is malfunctioning or damaged, transport the vehicle with the driving wheels on a carriage (Type C, D or E) as illustrated.

Operation under adverse driving conditions

CAUTION

- [For front-wheel drive vehicle equipped with the active stability control (ASC)]
If the vehicle is towed with the ignition switch in the “ON” position and only the front wheels or only the rear wheels raised off the ground, the ASC may operate, resulting in an accident. When towing the vehicle with only the front wheels or only the rear wheels raised, keep the ignition switch in the “LOCK” or “ACC” position.
- [For vehicle equipped with the Electronically controlled 4WD system]
Even in “2WD” mode, the vehicle cannot be towed with the front or the rear wheels on the ground.

8

Towing manual transaxle vehicles with rear wheels off the ground (Type B)

Place the gearshift lever in the “Neutral” position.
Turn the ignition switch to the “ACC” position and secure the steering wheel in a straight-ahead position with a rope or tie-down strap. Never place the ignition switch in the “LOCK” position when towing.

Towing with front wheels off the ground (Type C)

Release the parking brake.
Place the gearshift lever in the “Neutral” position (manual transaxle) or the selector lever in the “N” (NEUTRAL) position (CVT).

WARNING

- To prevent entry of exhaust gas from the towing vehicle, set the selection switch to the recirculation position.

Operation under adverse driving conditions

N00837200662

If your vehicle becomes stuck in sand, mud or snow

If your vehicle becomes stuck in snow, sand, or mud, it can often be moved by a rocking motion. Rock your vehicle back and forth to free it.

Do not rev the engine or spin the wheels. Constant efforts to free a stuck vehicle can cause overheating and transaxle failure. Let

the engine idle for a few minutes to cool the transaxle before trying again.

If your vehicle is still stuck after several rocking attempts, call for a commercial tow truck service.

WARNING

- When trying to rock your vehicle out of a stuck position, make sure that there are no people nearby. The rocking motion can make your vehicle suddenly lurch forward or backward, and injure any bystanders.

On wet roads

CAUTION

- Avoid flooded roads. Water is often deeper than it looks, and you could be seriously hurt by driving into flood water.
- When driving in rain, on water-covered roads, or through a car wash, water could get into the brake discs and make them fail temporarily. In such cases, lightly press the brake pedal to see if they are working properly. If they are not, press the pedal lightly several times while driving to dry the brake pads or linings, then check them again.

Fuel Pump Shut-off System

CAUTION

- When driving in rain, a layer of water may form between the tires and the road surface (aquaplaning). This loosens your tires' grip on the road, making it difficult to steer or brake properly. When driving on a wet road:
 - Drive your vehicle at a safe speed.
 - Do not drive on worn tires.
 - Always keep the tires at the correct inflation pressures.

On snowy or icy roads

- When driving on a road covered with snow or ice, use snow tires. Tire chains cannot be used on your vehicle. There may be state or local regulations about using snow tires. Always check the regulations in your local area before using them. Refer to the section entitled "Snow tires" on page 9-24 and "Tire chains" on page 9-24.
- Drive slowly. Do not make sudden starts or stops, sharp turns, or slam on the brakes.
- Allow extra distance between your vehicle and the vehicle in front of you, and avoid sudden braking.
- If a skid occurs when the accelerator pedal is depressed, take your foot off the pedal. Steer gently in the direction of the skid.

- Your vehicle is equipped with an anti-lock braking system (ABS), hold the brake pedal down firmly and keep it depressed. Do not pump the brake pedal which will result in reduced braking performance.
- After parking on snowy or icy road, it may be difficult to move your vehicle due to freeze-up of the brake. Depress the accelerator pedal little by little to move the vehicle after confirming safety of the vehicle.

CAUTION

- Do not depress the accelerator pedal rapidly. The vehicle could start moving when it breaks free from the ice, possibly resulting in an accident.

On a bumpy or rutted road

- Drive as slow as possible when driving on bumpy or rutted roads or over potholes etc.

CAUTION

- Driving on bumpy, rutted roads or over potholes can damage the tires and wheels. Wheels with low-profile tires or under-inflated tires are especially at risk for damage.

CAUTION

- The vehicle's body, bumper, muffler and other parts may be damaged if the vehicle is:
 - driven over a step (for example, at the entrance or exit of a parking lot);
 - parked too closely against a curb or parking block, or by the side of a road with curbstones;
 - driven on a steep slope;

Fuel Pump Shut-off System

N0086060044

8

WARNING

- **Before attempting to restart the engine after a collision, always inspect the ground under the vehicle for leaking fuel. If a fuel leak is found or a fuel odor is detected, do not restart the engine.**
- **Mitsubishi Motors recommends that your vehicle be inspected by an authorized Mitsubishi Motors dealer after any collision.**

In the event of a collision causing frontal air-bag deployment, the fuel pump shut-off system will activate to stop fuel supply to the engine.

For emergencies 8-15

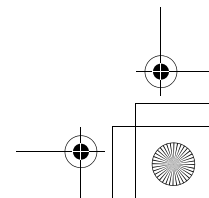
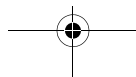
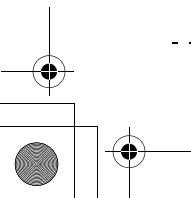
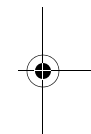
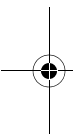
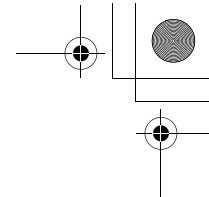

Horizontal dashed lines for text alignment, consisting of 10 parallel lines across the page.

Vehicle care and maintenance

Service precautions	9-2	Fusible links	9-28
Catalytic converter	9-2	Fuses	9-29
Engine hood	9-3	Replacement of light bulbs	9-34
View of the engine compartment	9-5	Vehicle care precautions	9-48
Engine oil and oil filter	9-6	Cleaning the inside of your vehicle	9-48
Engine coolant	9-8	Cleaning the outside of your vehicle	9-49
Air cleaner filter	9-9		
Manual transaxle oil (if so equipped)	9-11		
Continuously variable transmission (CVT) fluid (if so equipped)	9-11		
Twin Clutch Sportronic shift transmission (Twin Clutch SST) fluid (if so equipped)	9-12		
Transfer oil (All-wheel drive models)	9-12		
Rear axle oil (All-wheel drive models)	9-12		
AWC control fluid (if so equipped)	9-12		
Washer fluid	9-13		
Brake fluid/Clutch fluid (if so equipped)	9-13		
Power steering fluid (if so equipped)	9-14		
Battery	9-14		
Tires	9-17		
Clutch pedal free play (if so equipped)	9-24		
Brake pedal free play	9-25		
Parking brake lever stroke	9-25		
Parking brake break-in	9-25		
Wiper blades	9-25		
Emission-control system maintenance	9-25		
General maintenance	9-27		
For cold and snowy weather	9-28		

Service precautions

Service precautions

N00937301397

Taking regular care of your vehicle will preserve its value and appearance as long as possible.

You can do some of the maintenance work yourself, and the rest should only be performed by an authorized Mitsubishi Motors dealer or a repair facility of your choice.

If you discover a malfunction or other problem, have it corrected by an authorized Mitsubishi Motors dealer or a repair facility of your choice.

9

This section describes the maintenance inspections that you can do yourself, if you so desire. Follow the instructions and precautions for each procedure.

WARNING

- When checking or servicing the inside of the engine compartment, be sure the engine is stopped and has had a chance to cool down.
- If you need to work in the engine compartment with the engine running, be especially careful that your clothing, hair, etc. does not get caught in the fan, drive belts, or other moving parts.

WARNING

- The fan can turn on automatically even if the engine is not running. Turn the ignition switch to the “LOCK” position to be safe while you work in the engine compartment.
- Do not smoke or allow open flames around fuel or the battery. The fumes are flammable.
- Be extremely careful when working around the battery. It contains poisonous and corrosive sulfuric acid.
- Do not get under your vehicle while it is on a jack.
Always use properly rated automotive jack stands.
- Handling your vehicle’s parts and materials in the wrong way can injure you. Ask an authorized Mitsubishi Motors dealer or a repair facility of your choice if you have questions.



DIAMOND CARE PROTECTION PLAN

Have you purchased the Mitsubishi Motors Diamond Care Protection Plan? The Plan supplements your new vehicle warranties. See your authorized Mitsubishi Motors dealer for details.

Catalytic converter

N00937400131

The catalytic converter requires you to use unleaded fuel only. Leaded gasoline will destroy the emission-control effectiveness of the converter.

Normally, the catalytic converter does not require maintenance. However, it is important to keep the engine properly tuned for the converter to continue to work properly.

Engine hood

⚠ CAUTION

- Damage to the catalytic converter can result if your vehicle is not kept in proper operating condition. If the engine malfunctions or misfires, or if your vehicle performance suffers, have it serviced promptly. Running your vehicle when it is overheated may result in damage to the converter and vehicle.

⚠ WARNING

- Do not park or run your vehicle in areas where combustible materials such as dry grass or leaves can come in contact with a hot exhaust, since a fire could occur.
- Do not put undercoat paint on the catalytic converter.

To reduce the possibility of catalytic converter damage:

- Use UNLEADED GASOLINE ONLY of the type of recommended in “Fuel selection”.
- Do not drive with an extremely low fuel level. Running out of gas could damage the catalytic converter.
- Do not try to start the engine by pushing or towing the vehicle. If the battery is weak or run down, use jumper cables to properly start the engine.

- Do not idle the engine with any spark plug wires disconnected or removed, such as when performing diagnostic tests.
- Do not idle the engine for a long time if it is idling roughly or otherwise obviously malfunctioning.
- To prevent the catalytic converter from being damaged from unburned gas, do not race the engine when turning off the ignition switch.
- Stop driving the vehicle if you think the performance is less than normal, the engine is running oddly or there is any other engine trouble, such as with the ignition, etc. If you are not able to stop driving immediately, slow down and drive for only a short time. Have an inspection made by an authorized Mitsubishi Motors dealer or a repair facility of your choice as soon as possible.
- In unusual situations involving major engine problems, a burning odor may indicate severe and abnormal catalytic converter overheating. If this occurs, stop in a safe place, shut the engine off and let the vehicle cool. Once the engine is cool, immediately take your vehicle to a dealer or a repair facility of your choice for service.

Engine hood

N00937500464

⚠ CAUTION

- For vehicles with turbocharger, to avoid the risk of being burned, do not touch the air outlet (A) and air scoop (B) on the engine hood when the engine compartment is hot (when the engine is running or immediately after the vehicle has been driven).

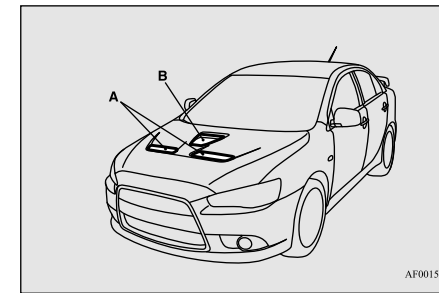

AF0015173

9

To open

Use the engine hood release lever (located under the instrument panel near the driver's door) to unlock the engine hood.

Engine hood

Pull the lever toward you to release the engine hood latch.

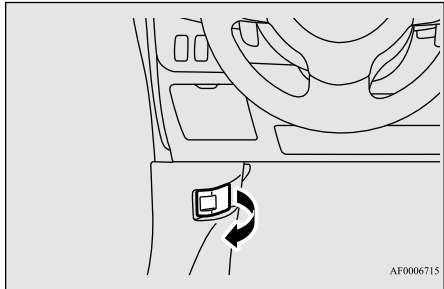

Release the safety lever and lift the engine hood.

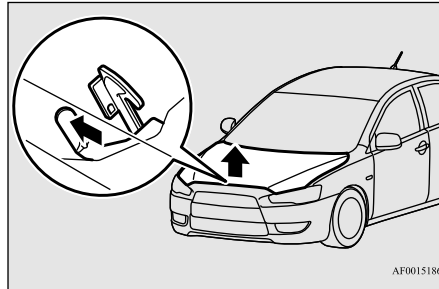

Support the engine hood with the hood prop. Insert the hood prop securely in the opening under the hood marked with an arrow.

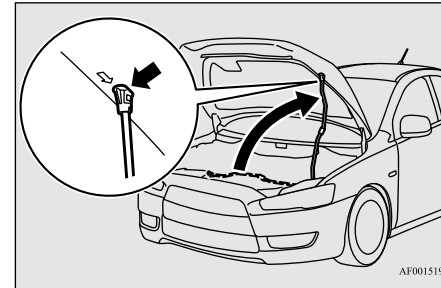

9

⚠ WARNING

- Never use the release lever to unlatch the engine hood while the vehicle is in motion.
- Do not drive your vehicle unless the engine hood is locked.

📖 NOTE

- To prevent damage to the engine hood and wipers, make sure the wipers are at resting position when you open the engine hood.

⚠ CAUTION

- Always insert the support prop into the hole specially made for it. Propping the engine hood at any other place could cause the prop to slip out and lead to an accident.
- The hood prop can fall out if the hood is lifted by a strong wind.

To close

Unlatch the prop from the engine hood and put it back in its retainer.

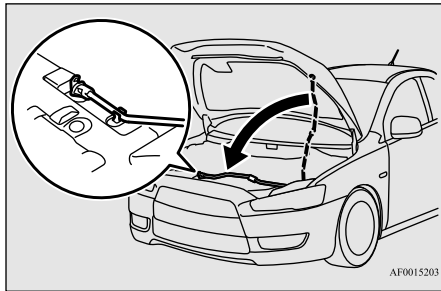

Slowly lower the engine hood about 8 inches (20 cm), then let it drop from its own weight.

CAUTION

- Be careful not to trap your hands or fingers when closing the engine hood.
 - Make sure the engine hood is firmly closed before driving.
- If you drive without the engine hood completely closed, it could open up while driving.

NOTE

- If this does not close the engine hood properly, drop it again from a slightly higher position.

NOTE

- Do not push down strongly on the engine hood. Depending on how strongly or where you push down, you could create a dent in the vehicle body.
- For vehicles equipped with the theft-alarm system, if you drive with the engine hood left open, warning display is displayed on the information screen in the multi-information display.

Type 1



Type 2



View of the engine compartment

View of the engine compartment

N00937600667

Except for vehicles with turbocharger

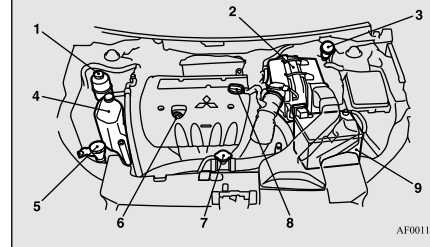

Vehicles with turbocharger

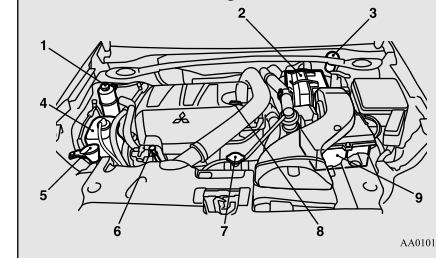

- 1- Power steering fluid reservoir (if so equipped)
- 2- Air cleaner filter
- 3- Brake fluid/Clutch fluid reservoir (if so equipped)
- 4- Engine coolant reservoir
- 5- Windshield washer fluid reservoir

Vehicle care and maintenance 9-5

Engine oil and oil filter

- 6- Engine oil level dipstick
- 7- Radiator cap
- 8- Engine oil filler cap
- 9- Battery

Engine oil and oil filter

N00937702040

To check and refill engine oil

It is normal for an engine to use oil. You may need to add oil between the recommended oil change intervals. Before starting the engine, check the engine oil level. Refill if necessary.

9

To check the oil level, remove the dipstick, wipe it off, and gently insert it all the way into the crankcase. Slowly remove it again. The oil level must not go above the line on the dipstick.

If the level does not reach the line, which shows the smallest amount of oil required, remove the oil filler cap on the engine valve cover, and fill to within the "Good" range.

Except for vehicles with turbocharger

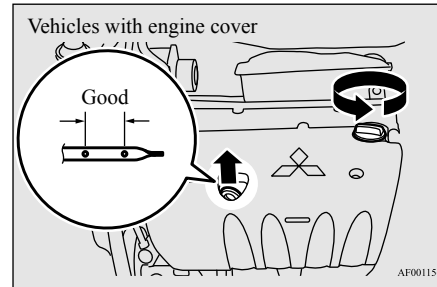
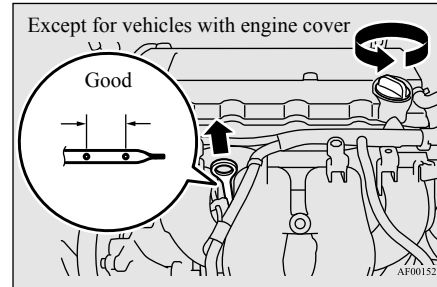

Vehicles with turbocharger

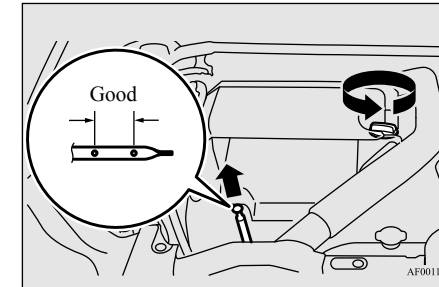

CAUTION

- Overfilling the crankcase will cause oil aeration and loss of oil pressure, which could damage the engine.

WARNING

- Used engine oil is poisonous, and can damage your skin. Prolonged and repeated contact may cause serious skin disorders, including dermatitis and cancer. Don't let used oil touch your skin. Wash thoroughly after working with it.
- Keep used oil out of the reach of children.

NOTE

- Engine oil consumption is greatly influenced by payload, engine speed, etc.

NOTE

- The engine oil will deteriorate rapidly if the vehicle is subjected to severe conditions (for example, repeated operation on rough roads, in mountainous regions, on roads with many uphill and downhill gradients, or over short distances). Consequently, the oil will require earlier replacement in accordance with the schedule in the “WARRANTY AND MAINTENANCE MANUAL”.

Engine oil identification mark

Mitsubishi Motors recommends using only engine oils with the ILSAC certification symbol on the front of the container.

ILSAC certification symbol



AHA100692

If you cannot find oils with the ILSAC certification symbol, use an API classification SN or higher oil with the following label.

This mark appears on the top of the oil container and tells you two important things about the oil.

API service symbol

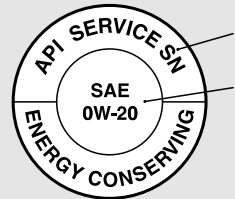

AH0000849

- 1- The top portion shows the quality of the oil.
- 2- The center portion shows the SAE grade of the oil viscosity.

Recommended engine oil viscosity

N00955001136

Use engine oil with the proper thickness for the outdoor temperatures where you will be driving.

Except for vehicles with turbo-charger

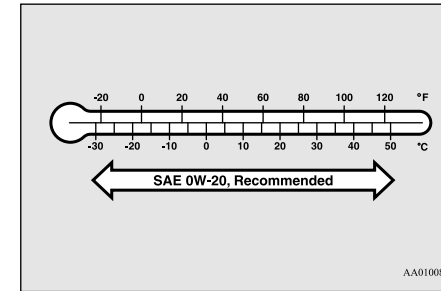

AA0100852

Mitsubishi Motors Genuine 0W-20 Synthetic Engine Oil is recommended for optimum fuel economy and cold weather starting. If Mitsubishi Motors Genuine 0W-20 Synthetic Engine Oil is not available, 5W-20 grade oils displaying the ILSAC certification can be used. However, Mitsubishi Motors Genuine 0W-20 Synthetic Engine Oil should be used at the next oil change to maintain optimum fuel economy and cold weather starting.

Engine coolant

Vehicles with turbocharger

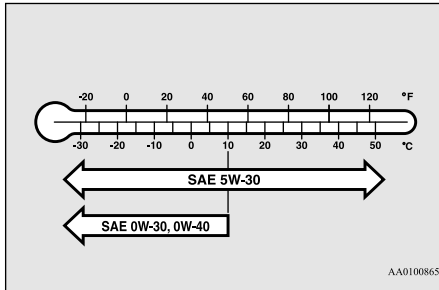

9

Mitsubishi Motors Genuine 5W-30 Engine Oil is the recommended oil for optimum engine performance and protection. SAE 0W-30 or 0W-40 engine oil is recommended to improve engine starting in cold weather conditions. Refer to temperature chart.

NOTE

- Select engine oil of the proper SAE viscosity number according to the atmospheric temperature.

To replace the oil filter

N00955100042

The oil filter should be replaced at the time or mileage specified in the “WARRANTY AND MAINTENANCE MANUAL”. Only use high quality replacement filters on this vehicle. The manufacturer’s specifications for Genuine Mitsubishi oil filters require that the filter can withstand a pressure of 256 psi (1.8 MPa). A Genuine Mitsubishi oil filter is the best replacement filter. Follow the installation instructions printed on the filter.

Engine coolant

N00937800542

To check the coolant level

The coolant reserve tank (A) lets you quickly see when you need to add coolant. When the engine is cold, the level in the reserve tank should be between the “FULL” and “LOW” marks. The radiator usually stays full so there is no reason to remove the radiator cap (B)

except when you check the coolant freeze point or replace the antifreeze coolant.

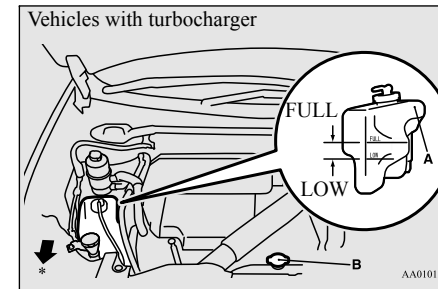
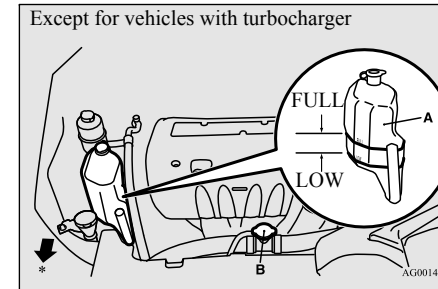

*- Front of the vehicle

To add coolant

Use “Mitsubishi Motors Genuine Super Long Life Coolant Premium” or an equivalent*.

* : similar high quality ethylene glycol based non-silicate, non-amine, non-nitrate and non-borate coolant with long life hybrid organic acid technology
 Mitsubishi Motors Genuine Coolant provides excellent protection against corrosion and rust formation on all metals, including aluminum, and prevents blockages in some parts of engine.

If you need to add coolant often, or if the level in the reserve tank does not drop when the engine cools, the cooling system should be pressure-tested for leaks. Take your vehicle to an authorized Mitsubishi Motors dealer or a repair facility of your choice for testing.

CAUTION

- Do not use alcohol or methanol antifreeze or any engine coolants that contain them. Using the wrong antifreeze can corrode aluminum parts.
- The required concentration of anti-freeze differs depending on the expected ambient temperature.
 Above -31 °F (-35 °C) : 50 % concentration of anti-freeze
 Below -31 °F (-35 °C) : 60% concentration of anti-freeze
 You can check the concentration level with a gauge from an automotive supply store, or your authorized Mitsubishi Motors dealer or service station can check it for you.

CAUTION

- Do not use water to adjust the concentration of coolant.
- Do not top off the tank with plain water only. Water by itself boils at a lower temperature and does not stop rust or freezing. If the water freezes, it will damage your cooling system. Do not use tapwater. It can cause corrosion and rust.

Radiator cap

The radiator cap must be tight sealed to prevent losing coolant which may result in engine damage. Only use a Genuine Mitsubishi Parts radiator cap, or an approved equivalent.

WARNING

- Wait for the engine to cool down before opening the radiator cap. Otherwise hot steam or boiling coolant could spray up from the radiator and scald you.

Points to remember

- Do not overfill the reserve tank.

Air cleaner filter

- Your vehicle uses a special radiator cap that stays sealed and lets the coolant flow from the reserve tank back to the radiator when the engine cools down. If you need to change the cap, use the exact same kind.
- Check the coolant freeze point in the radiator with the proper gauge, and only when it is safe. If you add antifreeze, the contents of the reserve tank must be protected against freezing.
- Keep the front of the radiator and condenser clean.
- If the temperature of the engine coolant does not rise after the engine is warmed-up, take your vehicle to an authorized Mitsubishi Motors dealer or a repair facility of your choice to have the thermostat checked, and replaced if necessary.

9

Air cleaner filter

N00937901481

The air cleaner filter will get dirty and dusty from use and not filter properly. Replace it with a new filter using the schedule in the "WARRANTY AND MAINTENANCE MANUAL".

1. Remove the clips (A), then remove the duct (B).

Air cleaner filter

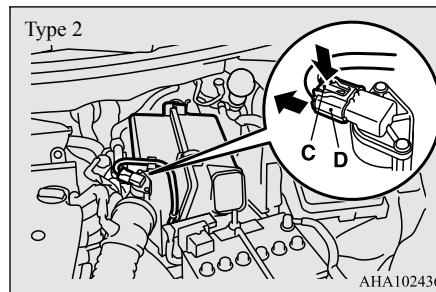
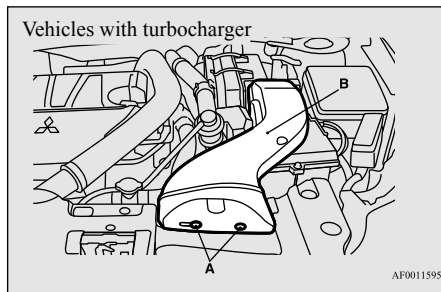
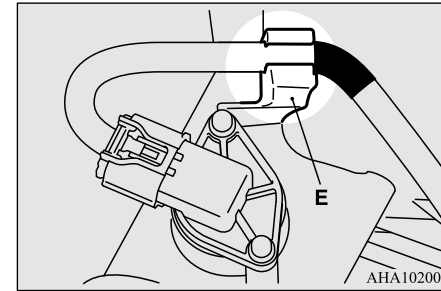
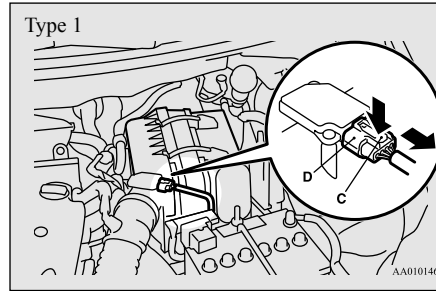
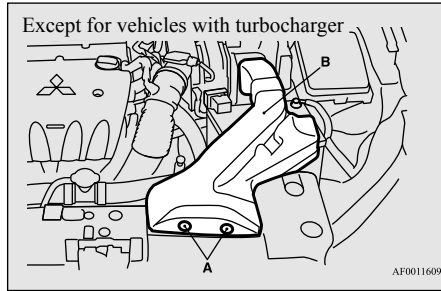

4. Unclamp and take out the air cleaner filter.

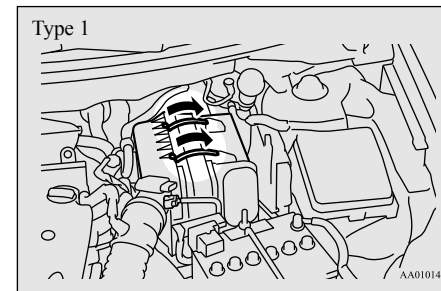

2. Except for vehicles with turbocharger, while holding down the tab (C), pull out the connector (D).

3. On vehicles with Type 2, remove the harness from the air cleaner hook (E).

9

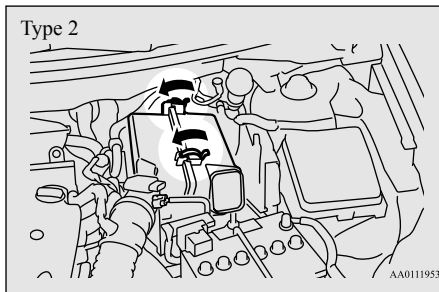

5. Install the air cleaner filter and put the cover back on in its original position.

NOTE

- Genuine Mitsubishi Motors Parts are recommended when replacing the air cleaner filter.
- After replacing the air cleaner filter, make sure that the hinges at the bottom of cover are firmly set.

Except for vehicles with turbocharger

NOTE

Vehicles with turbocharger

- On vehicles with Type 2, after replacing the air cleaner filter, make sure that harness is firmly set so that the air cleaner hook (E) and the marking tape (F) on the harness are located as shown in the illustration.

- Except for vehicles with turbocharger, make sure that the connector is properly reconnected.

6. Put the duct back on in its original position.

Manual transaxle oil (if so equipped)

Manual transaxle oil (if so equipped)

N00938200165

Whenever the manual transaxle oil level is checked, add oil to maintain the proper level, if necessary.

Refill or change the oil according to the table.

Oil type

Lubricant	Mitsubishi Motors Genuine NEW MULTI GEAR OIL API Classification GL-3
Viscosity range	SAE 75W-80

9

Continuously variable transmission (CVT) fluid (if so equipped)

N00938101116

The continuously variable transmission (CVT) should be maintained and serviced by an authorized Mitsubishi Motors dealer or a repair facility of your choice to obtain the best performance and longest life. It is important that the transmission fluid is kept at the correct level.

Twin Clutch Sportronic shift transmission (Twin Clutch SST) fluid (if so equipped)

Fluid type

Use only “Mitsubishi Motors Genuine CVTF-J4” transmission fluid to ensure optimum transmission performance.

CAUTION

- Using the improper transmission fluid may damage the transaxle.

Special additives

9

Mitsubishi Motors Corporation does not recommend the addition of any fluid additives to the transmission.

Twin Clutch Sportronic shift transmission (Twin Clutch SST) fluid (if so equipped)

N00938300036

The Twin Clutch Sportronic shift transmission (Twin Clutch SST) should be maintained and serviced by an authorized Mitsubishi Motors dealer or a repair facility of your choice to obtain the best performance and longest life. It is important that the transmission fluid is kept at the correct level.

9-12 Vehicle care and maintenance

Fluid type

Use only Mitsubishi Motors Genuine SSTF-I to ensure optimum transmission performance.

CAUTION

- Using the improper transmission fluid may damage the transaxle.

Special additives

Mitsubishi Motors Corporation does not recommend the addition of any fluid additives to the transmission.

Transfer oil (All-wheel drive models)

N00938400239

Whenever the transfer oil level is checked, add oil as necessary to maintain the proper level. Fill or change the oil according to the table.

Oil type

Lubri- cant	Mitsubishi Motors Genuine LSD gear oil or equivalent
----------------	--

Rear axle oil (All-wheel drive models)

N00915200227

Whenever the oil level is checked, add oil as necessary to maintain the proper level. Fill or change oil according to the table.

Oil type

Lubri- cant	Mitsubishi Motors Genuine LSD gear oil or equivalent
----------------	--

AWC control fluid (if so equipped)

N00915300026

To check the fluid level

Remove the lid on the trunk room right side trim.

Check the fluid level in the reservoir 90 minutes or more after turning the ignition switch to the “LOCK” position.

Check to make certain that the AWC control fluid level is always between the “MAX” and “MIN” level markings on the fluid reservoir and refill the fluid, if necessary.

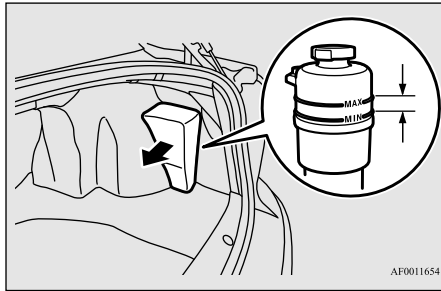

Fluid type

Lubricant	DIAMOND ATF SP III
-----------	--------------------

Washer fluid

N00938600273

The windshield washer fluid reservoir is in the engine compartment.

Check the washer fluid level at regular intervals and add washer fluid to reservoir if necessary. Open the reservoir cap and check the fluid level with the dipstick.

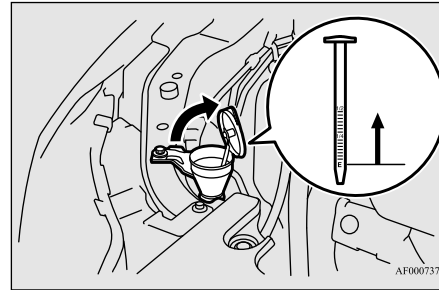

During cold weather

When freezing weather is anticipated, flush out the water in the reservoir by operating the pump. Fill the reservoir with windshield anti-freeze (not radiator antifreeze), and operate the system for a few seconds to flush out the residual water.

Washer fluid

Brake fluid/Clutch fluid (if so equipped)

N00938700186

The brake fluid and the clutch fluid share the reservoir tank.

To check the fluid level

The fluid level must be between the "MAX" and "MIN" marks on the reservoir.

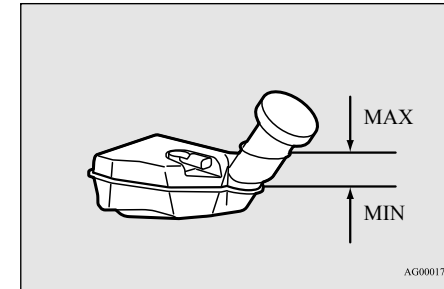

9

The fluid level falls slightly with wear of the brake pads, but this does not indicate any abnormality.

The fluid in the master cylinder should be checked when doing other work under the engine hood. The brake system should also be checked for leaks at the same time.

Power steering fluid (if so equipped)

If the fluid level falls markedly in a short length of time, it indicates leaks from the brake system.

If this occurs, have the vehicle checked by an authorized Mitsubishi Motors dealer or a repair facility of your choice.

Fluid type

Use the recommended brake fluid conforming to DOT 3 or DOT 4. The reservoir cap must be tightly sealed to keep dirt and water out.

9

CAUTION

- Do not let any petroleum-based fluid touch, mix with, or get into the brake fluid. This will damage the seals.
- Be careful when handling brake fluid. It can damage painted surfaces.
- Use only the listed brake fluid. Different brands of brake fluid have different additives, and these can cause a chemical reaction. Do not mix brands of brake fluid.
- Keep the reservoir tank cap closed to keep the brake fluid from evaporating.

Power steering fluid (if so equipped)

N0093900388

To check the fluid level

Check the fluid level in the reservoir while the engine is idling.

Check to make certain that the power steering fluid level is always between the “MAX” and “MIN” level markings on the fluid reservoir and refill the fluid, if necessary.

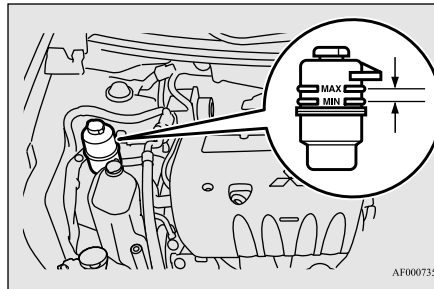

AF0007350

Fluid type

Lubricant	Mitsubishi Motors Genuine Power Steering Fluid
-----------	--

Battery

N00939100783

The condition of the battery is very important for quick starting and to keep the vehicle’s electrical system working properly. Check the battery regularly.

WARNING

- An SRS airbag sensor is located in the front of the engine compartment near the battery. When checking or replacing the battery, or when working around this area, do not strike or damage this sensor.

Removing and installing the battery upper cover (vehicles with turbocharger)

N00901300012

WARNING

- Turn the ignition key to the “LOCK” position on vehicle. Make sure that your clothes cannot be caught by the fan or drive belt. Personal injury could result.

Battery

To remove

1. Remove the clips (A), and then remove the air duct (B).

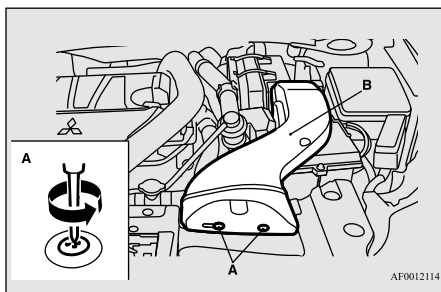

2. Turn the plastic nuts (C) counterclockwise, and then remove the battery upper cover (D).

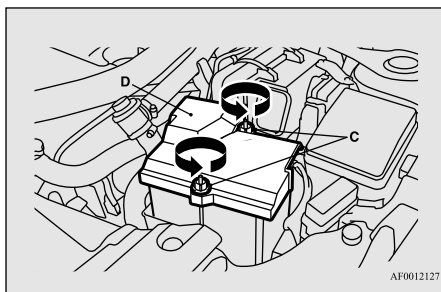

NOTE

- Be careful not to lose the removed plastic nuts.

To install

1. Install the battery upper cover (A) onto the battery, and then push the plastic nuts (B) in the direction shown by the arrows to secure the cover.

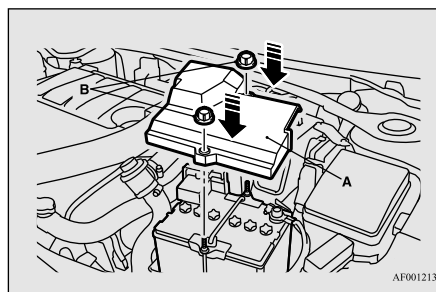

NOTE

- Be sure to install the plastic nuts in the correct direction.
- Make sure that the battery upper cover is installed securely.

2. To install the air duct, perform the removal steps in reverse.

CAUTION

- Be sure to install the battery upper cover. Otherwise, the battery electrolyte may spill and cause a malfunction.
- When installing the battery upper cover, plastic nuts, and air duct, do not touch the cooling fan or other moving parts in the engine compartment. Be especially careful that the cables, your clothing or hair, etc., do not get caught in the cooling fan or other moving parts.

Checking battery electrolyte level

N00901500014

9

The electrolyte level must be between the limits shown on the outside of the battery. Fill it with distilled water as needed. The inside of the battery is divided into several compartments. Take the cap off of each compartment and fill to the mark.

Do not fill above the top line because a spill during driving could cause damage.

Battery

Except for vehicles with turbocharger

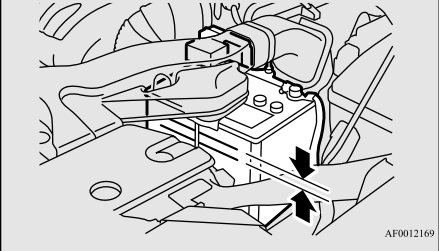

Vehicles with turbocharger

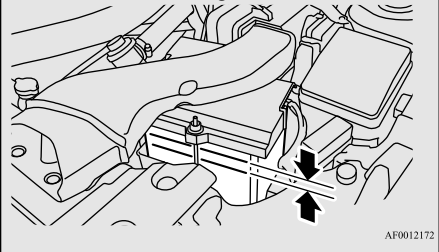

9

⚠ WARNING

- If the battery goes flat, be sure to check the battery electrolyte level before connecting booster cables.
- After checking the battery electrolyte level, make sure the caps are fitted securely.
- If any of the caps has a loose fit, replace the battery.

NOTE

- For vehicles equipped with a turbocharger, the battery upper cover does not need to be removed to check the battery electrolyte level.

During cold weather

N00901600015

The battery is weaker in cold temperatures. This has to do with its chemical and physical properties and is why a very cold battery, especially one with a low charge, will have a hard time starting your vehicle.

It is recommended that you have your battery and charging system checked by an authorized Mitsubishi Motors dealer or a repair facility of your choice before the start of cold weather. If necessary, have it charged. This will guarantee more reliable starting, and longer battery life.

Disconnection and connection

N00901701084

To disconnect the battery cable, stop the engine. Disconnect the negative (-) terminal first, then the positive (+) terminal. To reconnect the battery, first connect the positive (+) terminal and then the negative (-) terminal, before starting the vehicle.

NOTE

- For vehicles equipped with turbocharger, remove the battery upper cover before disconnecting the terminal of battery. Refer to “Removing and installing the battery upper cover” on page 9-14.
- Open the terminal cover (A) before disconnecting or connecting the positive (+) terminal of the battery.

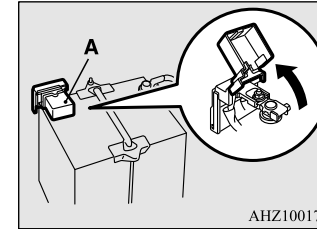

⚠ WARNING

- Never disconnect the battery while the engine is running, or you could damage the vehicle's electrical parts.
- Never short-circuit the battery. This could cause it to overheat and be damaged.
- Keep sparks, cigarettes, and flames away from the battery because the battery could explode.

⚠ WARNING

- **Electrolyte (battery acid) is made of corrosive diluted sulfuric acid. If it spills on nearby parts, it can crack, stain, or discolor them. And if gets on your skin or in your eyes, it can cause burns or blindness. Please observe the following handling instructions:**
 - If electrolyte gets on plastic parts or other nearby parts, wipe it off with a soft cloth or chamois soaked in a solution of water and neutral detergent then immediately rinse the affected parts with plenty of water.
 - If electrolyte gets on your hands or clothes, rinse thoroughly with water. If electrolyte gets in your eyes, flush them with water immediately and get immediate medical attention.
- **Open doors and windows in any closed space where you may be charging or working with the battery.**
- **Always wear protective clothing and goggles when working with the battery, or have a skilled automobile technician do it.**
- **If you are quick-charging your battery, first disconnect the battery cables.**
- **In order to prevent a short circuit, be sure to disconnect the negative (-) terminal first, and reconnect it last.**
- **If the electrolyte level is very low, have the battery checked at an authorized Mitsubishi Motors dealer or a repair facility of your choice.**

⚠ WARNING

- **Battery terminals and related accessories contain lead and lead compounds. Wash hands after handling.**

📖 NOTE

- Check each battery terminal for corrosion. You can stop more corrosion by washing with a solution of baking soda and water. Grease the posts and clamps after cleaning or tightening them.
- Check to see that the battery is securely installed and cannot be moved. Also check each terminal for tightness.
- If you will not be driving your vehicle for a long period of time, remove the battery and store it in a place where the battery fluid will not freeze. Memory data for settings made by the user may be erased when the battery is removed. If this happens, reset the settings again using the relevant procedures. The battery only should be stored with a full charge.
- Before cleaning the battery, tighten all the filler port caps to keep dirt and moisture out.

Tires

N00939201563

⚠ WARNING

- **Driving with tires that are worn, damaged or improperly inflated is dangerous. These type tire conditions will adversely affect vehicle performance. These type tire conditions can also cause a tread separation or blowout which may result in an accident causing serious injury or death.**
- **Tires, including spare tire, degrade over time with age even when they are not being used. It is recommended that tires over 6 years generally be replaced even if damage is not obvious.**

9

It is important to familiarize yourself with the following terms:

- **Cold tire pressure:**
 - The measured pressure after the vehicle has been parked for at least three hours, or
 - The measured pressure when the vehicle is driven less than 1 mile (1.6 km) after having been parked for three hours.
- **Maximum inflation pressure:** the maximum permissible cold tire inflation pressure for this tire.

Tires

- Recommended inflation pressure: the inflation pressure for optimum tire performance.
- Intended outboard sidewall:
 - The sidewall that contains a whitewall, bears white lettering or bears manufacturer, brand, and/or model name molding that is higher or deeper than the same molding on the other sidewall of the tire, or
 - The outward facing sidewall of an asymmetrical tire that has a particular side that must always face outward when mounted on a vehicle.
- Passenger car tire: a tire intended for use on passenger cars, multipurpose passenger vehicles, and trucks, that have a gross vehicle weight rating (GVWR) of 10,000 pounds or less.
- Light truck (LT) tire: a tire designated by its manufacturer as primarily intended for use on lightweight trucks or multipurpose passenger vehicles.
- Tread: portion of a tire that comes into contact with the road.
- Tread rib: a tread section running circumferentially around a tire.
- Tread separation: pulling away of the tread from the tire carcass.
- Carcass: the tire structure, except tread and sidewall rubber which, when inflated, bears the load.
- Sidewall: portion of a tire between the tread and bead.
- Section width: the linear distance between the exteriors of the sidewalls of an inflated tire, excluding elevations due to labeling, decoration, or protective bands.
- Bead: the part of the tire that is made of steel wires, wrapped or reinforced by ply cords and that is shaped to fit the rim.
- Ply: a layer of rubber-coated parallel cords.
- Cord: the strands forming the plies in the tire.
- Rim: a metal support for a tire or a tire and tube assembly upon which the tire beads are seated.
- Rim diameter: nominal diameter of the bead seat.
- Groove: the space between two adjacent tread ribs.

9

9-18 Vehicle care and maintenance

Tire Markings

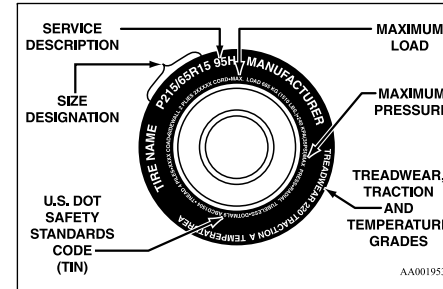

Size Designation

EXAMPLE: P215/65R15

P	Passenger car tire size based on U.S.A. design standards
215	Section width in millimeters (mm.)
65	Aspect ratio in percent (%) Ratio of section height to section width of tire.

R	Construction code •“R” means radial construction. •“D” means diagonal or bias construction.
15	Rim diameter in inches (in)

NOTE

- European/Japanese metric tire sizing is based on European/Japanese design standards. Tires designed to these standards have the tire size molded into the sidewall beginning with the section width. The letter “P” is absent from this tire size designation. Example: 215/65R15 96H.

NOTE

- LT (Light Truck) -metric tire sizing is based on U.S.A. design standards. The size designation for LT-metric tires is the same as for P-metric tires except for the letters “LT” that are molded into the sidewall preceding the size designation. Example: LT235/85R16.
- Temporary spare tires are high pressure compact spares designed for temporary emergency use only. Tires designed to this standard have the letter “T” molded into the sidewall preceding the size designation. Example: T145/80D18 103M.

Speed symbol

A symbol indicating the range of speeds at which a tire can carry a load corresponding to its load index under certain operating conditions.

H The maximum speed corresponding to the speed symbol should only be achieved under specified operating conditions. (i.e. tire pressure, vehicle loading, road conditions and posted speed limits)

Maximum Load

Maximum load indicates the maximum load this tire is designed to carry.

Service Description

EXAMPLE: 95H

95	Load index A numerical code associated with the maximum load a tire can carry.
----	---

Tires

WARNING

- **Overloading of your tire is dangerous. Overloading can cause tire failure, affect vehicle handling, and increase your stopping distance. Use tires of the recommended load capacity for your vehicle. Never overload them.**

9 Maximum Pressure

Maximum Pressure indicates the maximum permissible cold tire inflation pressure for this tire.

Tire Identification Number (TIN)

The TIN may be found on one or both sides of the tire but the date code may only be on one side. Look for the TIN on the outboard side of tires as mounted on the vehicle. If the TIN is not found on the outboard side then you will find it on the inboard side of the tire.

9-20 Vehicle care and maintenance

EXAMPLE: DOT MA L9 ABCD 1504

DOT	Department of Transportation This symbol certifies that the tire is in compliance with the U.S. Department of Transportation tire safety standards, and is approved for highway use.
MA	Code representing the tire manufacturing location. (2 digits)
L9 ABCD	Code representing the tire size. (2 digits) Code used by tire manufacturer. (1 to 4 digits)
15	Number representing the week in which the tire was manufactured. (2 digits)
04	Number representing the year in which the tire was manufactured. (2 digits)

Treadwear, Traction and Temperature Grades

Treadwear

The treadwear grade is a comparative rating based on the wear rate of the tire when tested under controlled conditions on a specified government test course. For example, a tire graded 150 would wear one and one-half ($1\frac{1}{2}$) times as well on the government course as a tire graded 100. The relative performance of tires depends upon the actual conditions of their use, however, and may depart significantly from the norm due to variations in driving habits, service practices and differences in road characteristics and climate.

Traction

The traction grades, from highest to lowest, are AA, A, B and C. Those grades represent the tire's ability to stop on wet pavement as measured

under controlled conditions on specified government test surfaces of asphalt and concrete. A tire marked C may have poor traction performance.

Temperature

The temperature grades are A (the highest), B and C, representing the tire's resistance to the generation of heat and its ability to dissipate heat when tested under controlled conditions on a specified indoor laboratory test wheel. Sustained high temperature can cause the material of the tire to degenerate and reduce tire life, and excessive temperature can lead to sudden tire failure. The grade C corresponds to a level of performance which all passenger car tires must meet under the Federal Motor Vehicle Safety Standard No. 109. Grades B and A represent higher levels of performance on the laboratory test wheel than the minimum required by law.

Tire inflation pressures

N00939300844

Proper tire inflation pressure is essential for the safe and satisfactory operation of your vehicle. The wrong tire pressure will cause problems in three major areas:

- Safety
Too little pressure increases flexing in the tire and can cause tire failure. Too much pressure can cause a tire to lose its ability to cushion shock. Objects on the road and potholes could then cause tire damage that may result in tire failure.
- Economy
The wrong tire pressure can cause uneven wear patterns in the tire tread. These abnormal wear patterns will reduce the tread life, and the tire will have to be replaced sooner.
Too little pressure also makes it harder for the tire to roll, and this uses up more fuel.
- Ride comfort and vehicle stability
The superior riding experience built into your vehicle partly depends on the correct tire pressure. Too much pressure gives an uncomfortable and jarring ride. Too little pressure feels as if your vehicle is slow to respond.
Unequal tire pressures can make steering your vehicle uneven and unpredictable.

Tires

The correct tire pressure for your vehicle is listed on the placard attached to the sill of the driver's door.

(Refer to "Tire and loading information placard" on page 11-3.)

The recommended inflation pressures should be used for the tires listed below.

Except for vehicles with turbo-charger

Item	Tire size	Front	Rear
Normal tire	P205/60 R16	250 KPA, 36 PSI	250 KPA, 36 PSI
	P215/45 R18	240 KPA, 35 PSI	240 KPA, 35 PSI
Compact spare tire	T125/70 D16 T125/90 D16	420 KPA, 60 PSI	

Vehicles with turbocharger

Item	Tire size	Front	Rear
Normal tire	P215/45 R18	240 KPA, 35 PSI	240 KPA, 35 PSI
	215/45R 18		

Tires

Item	Tire size	Front	Rear
Compact spare tire	T125/90 D16	420 KPA, 60 PSI	

Tire pressures should be checked, and adjusted if necessary, at least once a month. Pressures should be checked more often whenever weather temperatures change severely, because tire pressures change with outdoor temperatures. The pressures listed on the placard are always “cold inflation pressure”.

Cold inflation pressure is measured after the vehicle has been parked for at least three hours or is driven less than 1 mile (1.6 km) after having been parked for three hours.

Cold inflation pressure must not go above the maximum values molded into the tire sidewall. After driving several miles, your tire inflation pressure may increase 14 to 41 KPA, 2 to 6 PSI from the cold inflation pressure. Do not let air out of the tires to get back to the specified cold pressure, or your tire pressure will be too low.

Check your tires each time you refuel. If one tire looks lower than the others, check the pressure for all of them.

You should also take the following safety precautions:

- Keep your tires inflated to the recommended pressures. (See the tire and loading information placard attached to the sill of the driver’s door.)
- Stay within the recommended load limits.
- Make sure that the weight of any load in your vehicle is evenly distributed.
- Drive at safe speeds.
- After filling your tires to the correct pressure, check them for damage and air leaks. Be sure to reinstall the caps on the valve stems.

Replacing tires and wheels

N00939600368

CAUTION

- Avoid using different size tires and wheels from the ones listed, and avoid the combined use of different types of tires and wheels. Using different size or type tires and wheels may affect driving safety. Refer to “Tires and wheels” on page 11-5.

CAUTION

- For All-wheel drive vehicles, always use tires of the same size, same type, and same brand, and which have no wear differences. Using tires that differ in size, type, brand or the degree of wear, will increase the differential oil temperature, resulting in possible damage to the driving system. Further, the drive train will be subjected to excessive loading, possibly leading to oil leakage, component seizure, or other serious problems.
- Even if a wheel has the same rim size and offset as the specified type of wheel, its shape may prevent it from being fitted correctly. Consult an authorized Mitsubishi Motors dealer or a repair facility of your choice before using wheels that you have.
- Only Mitsubishi Motors genuine wheels should be used, because your vehicle is equipped with a tire pressure monitoring system. Use of another type of wheel risks air leaks and sensor damage, as it will not be possible to install the tire pressure sensor properly.

Tire maintenance

N00939700154

The following maintenance steps are recommended:

- Check tire pressures regularly.

- Have regular maintenance done on the wheel balance and front and rear suspension alignment.
- Rotate your tires regularly as described in the “Tire rotation” section on page 9-23.

Tread wear indicators

N00939800214

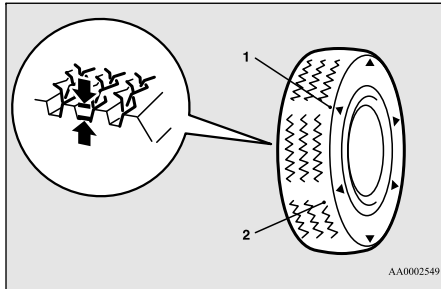

AA0002549

- 1- Location of the tread wear indicator
- 2- Tread wear indicator

Tread wear indicators are built into the original equipment tires on your vehicle to help you know when your tires should be replaced. Many states have laws requiring that you replace your tires at this point.

These indicators are molded into the bottom of the tread grooves and will appear when the tire tread is worn down to 1/16 inch (1.6 mm).

When the bands appear next to one another in two or more places, replace your tires.

NOTE

- Tire wear indicators can have different marks and locations depending on the tire manufacturer.

Tire rotation

N00939900390

To even out the wear on your tires and make them last longer, Mitsubishi Motors Corporation recommends that you rotate your tires at the mileage listed in the “WARRANTY AND MAINTENANCE MANUAL”.

However, the timing for tire rotation may vary according to your vehicle condition, road surface conditions, and your own personal driving habits. Any time you notice unusual wear, rotate your tires as soon as possible.

When rotating tires, check for uneven wear, damage, and wheel alignment. Abnormal wear is usually caused by a wrong tire pressure, wheels that are not aligned properly, wheels that are out-of-balance, or severe braking.

Check with an authorized Mitsubishi Motors dealer or a repair facility of your choice to find out the reason for uneven tread wear.

The first tire rotation is the most important one. It will allow all your tires to wear evenly.

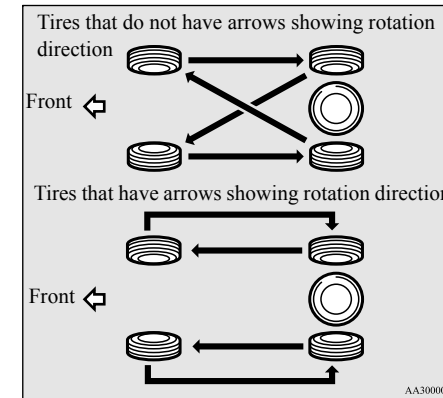

AA3000096

CAUTION

- A compact spare tire can be installed temporarily in place of a tire that has been removed during the tire rotation. However, it must not be included in the regular tire rotation sequence.

Clutch pedal free play (if so equipped)

⚠ CAUTION

- If the tires have arrows (A) indicating the correct direction of rotation, swap the front and rear tires on the left-hand side of the vehicle and the front and rear tires on the right-hand side of the vehicle separately. Keep each tire on its original side of the vehicle. When installing the tires, make sure the arrows point in the direction in which the wheels will turn when the vehicle moves forward. Any tire whose arrow points in the wrong direction will not perform to its full potential.

9

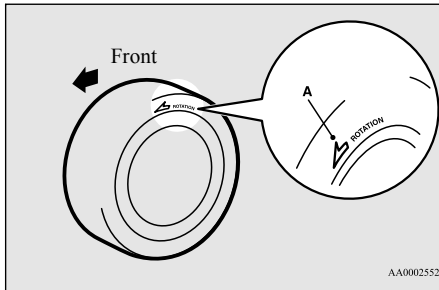

⚠ CAUTION

- Avoid the combined use of different types of tires. Using different types of tires can affect vehicle performance and safety.

Snow tires

N0094000359

In some areas of the country, snow tires are required for winter driving. If snow tires are required in your area, you must choose snow tires of the same size and type as the original tires provided with your vehicle. Snow tires should also be installed on all four wheels. Otherwise your safety and vehicle handling can be reduced.

Even where laws may permit it, snow tires should not be operated at sustained speeds over 75 mph (120 km/h).

⚠ CAUTION

- If flange nuts are used on your vehicle, change to tapered nuts when using snow tires with steel wheels.
- Only Mitsubishi Motors genuine wheels should be used, because your vehicle is equipped with a tire pressure monitoring system. Use of another type of wheel risks air leaks and sensor damage, as it will not be possible to install the tire pressure sensor properly.

Tire chains

N00940100129

⚠ CAUTION

- Tire chains cannot be used on your vehicle. The clearance between the chains and the body is not sufficient to allow proper clearance, and the vehicle body might be damaged.

Clutch pedal free play (if so equipped)

N00940201097

To check the clutch pedal free play (A), turn off the engine and press the pedal until you feel resistance.

Clutch pedal free play:
.2 to .4 inch (4 to 9 mm)

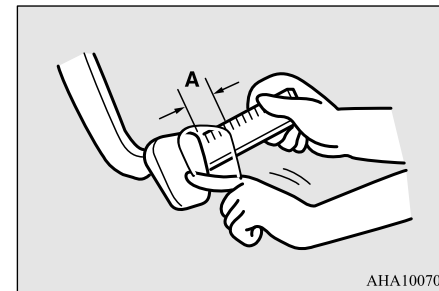

Brake pedal free play

N00940301333

To check the brake pedal free play (A), turn off the engine and press the brake pedal several times with your foot. Then press the pedal down with your fingers until you first feel resistance.

Brake pedal free play:
.1 to .3 inch (3 to 8 mm)

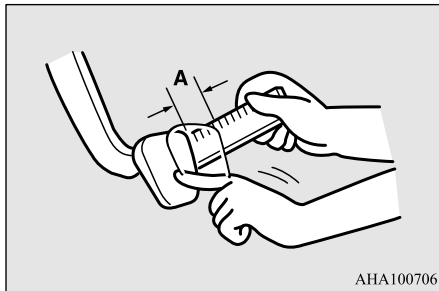

If the free play is not within these limits, take your vehicle to an authorized Mitsubishi Motors dealer or a repair facility of your choice for adjustment.

Parking brake lever stroke

N00940400180

Check the parking brake lever travel occasionally. To check this, pull the lever up

slowly and count the number of clicks of the ratchet.

Parking brake lever stroke:
3 to 5 notches

Also check to see if the lever stays gripped by the ratchet after pulling.

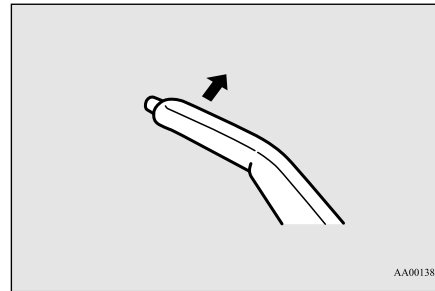

Parking brake break-in

N00936200031

Break-in the parking brake linings whenever the brake performance of the parking brake is insufficient or whenever the parking brake linings and/or discs are replaced, in order to assure the best brake performance.

This procedure is described in the vehicle service manual and can be carried out by an authorized Mitsubishi Motors dealer.

Brake pedal free play

Wiper blades

N00940700170

Check the wiper blades occasionally. Clean them regularly to remove deposits of salt and road film. Use a sponge or cloth and a mild detergent or non-abrasive cleaner to clean the blades and glass areas.

Replace the blades if they continue to streak or smear.

NOTE

- Do not run the wipers on dry glass for a long time. This wears out the rubber and can scratch the glass.

9

During cold weather

If the blades are frozen to the windshield or rear window, do not operate the wipers until the ice has melted and the blades are freed, otherwise the wiper motor may be damaged.

Emission-control system maintenance

N00940800201

Your vehicle is equipped with an emission-control system that meets all the requirements of the U.S. Environmental Protection Agency



Emission-control system maintenance

and Environment Canada. The emission-control system is made of:

- a positive crankcase ventilation system
- an evaporative emission-control system
- an exhaust emission-control system

The maintenance services listed in the “WARRANTY AND MAINTENANCE MANUAL” must be performed at the times or mileages listed to keep the emission-control system working properly. These, and all the other “general” maintenance services listed in this manual, need to be performed to keep your vehicle running properly and reliably.

9

You may need more frequent maintenance if you drive your vehicle in harsh conditions such as dusty areas or do a lot of start-and-stop driving.

To be sure the emission-control system works properly, have your vehicle inspected and maintained by an authorized Mitsubishi Motors dealer or a repair facility of your choice following the schedule in the “WARRANTY AND MAINTENANCE MANUAL”.

You should also have an inspection and service any time you suspect a malfunction.

9-26 Vehicle care and maintenance



NOTE

- To meet government regulations and promote cleaner air, your vehicle is equipped with an onboard diagnostic system (OBD). The engine electronic control module that controls OBD functions stores various data (especially about the exhaust emissions). This data will be erased if the battery cable is disconnected, which could make a rapid diagnosis difficult. Do not disconnect the battery cable when the engine malfunction indicator (“SERVICE ENGINE SOON” or “Check engine light”) is on.

Spark plugs

N00940900215

Spark plugs must fire properly for good engine performance and emission-control. Do not reuse them by cleaning or regapping. Change them at the mileage listed in the “WARRANTY AND MAINTENANCE MANUAL”.

NOTE

- Use the spark plugs listed under “Engine specifications” on page 11-5 or plugs that are exactly the same. Other plugs could cause engine damage, performance problems or radio noise.

Fuel hoses

N00941000037

Check the hose surfaces for any heat and mechanical damage, hard and brittle rubber, cracking, tears, cuts and abrasions. Pay special attention to the hoses closest to high heat sources such as the exhaust manifold. Check all the hose connections, such as clamps and couplings, to make sure they are secure and that there are no leaks. If you see any wear or damage, replace the hoses immediately.

Intake valve clearance

N00950100050

Have the valve clearance checked at an authorized Mitsubishi Motors dealer at the mileage specified in the “WARRANTY AND MAINTENANCE MANUAL”. If the engine sounds abnormally loud, have adjustments made by an authorized Mitsubishi Motors dealer.

Fuel system (tank, pipe line and connection, and fuel tank filler cap)

N00941300085

Check these regularly for damage or leaks in the fuel lines and connections. Check the fuel tank filler cap for damage or looseness. Pay special attention to the fuel lines closest to

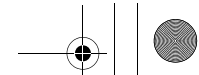

high heat sources such as the exhaust manifold.

⚠ WARNING

- If you see a fuel leak or if you smell fuel, do not run the engine. Any spark (including from the ignition), flame or smoking material could cause an explosion or fire. Call an authorized Mitsubishi Motors dealer or a repair facility of your choice for assistance.

Evaporative emission control system (except evaporative emission canister)

N00941400116

If the fuel-vapor vent line is clogged or damaged, the fuel-vapor mixture will escape, polluting the air.

Have the system checked at an authorized Mitsubishi Motors dealer at the mileage specified in the “WARRANTY AND MAINTENANCE MANUAL”.

General maintenance

N00941500159

The next pages list the maintenance service recommended by Mitsubishi Motors Corporation. In addition to the general maintenance that needs to be performed at the times listed,

there are other parts which do not usually need regular maintenance.

But, if any of these parts stops working properly, your vehicle performance could suffer. Have these items checked if you notice a problem with them.

See your authorized Mitsubishi Motors dealer for assistance, if you have any questions.

Disc brake pads, rear drum brake linings and rear wheel cylinders

N00941600033

Good brakes are essential to safe driving. Check the brake pads and brake linings for wear and check the rear wheel cylinders for leaks. For good braking performance, replace the brake pads with the same type pads as the originals.

Brake hoses

N00941700047

Brake hoses and tubing should be checked for:

General maintenance

- Severe surface cracking, scuffing or worn spots. If the fabric casing of the hose is showing through any cracks or worn spots in the rubber hose cover, the hose should be replaced. The brakes can fail if the hose wears through.
- Improper installation may cause twisting, or wheel, tire or chassis interference.

Ball joint, steering linkage seals and drive shaft boots

N00941800077

Check the following parts for damage and grease leaks:

- Ball joint boots of the front suspension and steering linkage
- Bellows on both ends of the drive shaft

9

Exhaust system

N00942200108

⚠ WARNING

- Carbon monoxide gas from your vehicle's exhaust is poisonous. Breathing these fumes can cause unconsciousness or death.

The best way to keep carbon monoxide gas from entering inside your vehicle is to have the engine exhaust system properly serviced.



For cold and snowy weather

Have a competent mechanic inspect the complete exhaust system and nearby body areas for broken, damaged, deteriorated, or mispositioned parts if you notice any of the following:

- A change in the sound of the exhaust system
- The smell of exhaust fumes inside the vehicle
- The underside or rear of the vehicle is damaged

Also check the exhaust system each time the vehicle is raised for lubrication, oil changes, or required service. Any open seams or loose connections could let dangerous exhaust fumes seep into the luggage compartment and passenger compartments.

9

Check for any of the following conditions:

- Check for holes or exhaust gas leaks caused by corrosion or damage.
- Check the joints and connections for looseness or exhaust gas leaks.
- Check the rubber hangers and brackets for damage.

9-28 Vehicle care and maintenance



Hood lock release mechanism and safety catch

N00942500114

The hood lock release mechanism and hood safety catch should be checked, cleaned, and oiled when needed for easy movement and to stop rust and wear. Use Multipurpose Grease NLGI Grade 2 sparingly for all sliding parts of the hood latch and release lever. Work the grease into the hood lock mechanism until all the movable surfaces are covered.

Also, put a light coat of the same grease on the safety catch wherever moving parts touch.

For cold and snowy weather

N00942600102

Ventilation slots

The ventilation slots in front of the windshield should be brushed clear after a heavy snowfall so that the operation of the heating and ventilation systems will not be impaired.

Weatherstripping

To prevent freezing of the weatherstripping on the doors, engine hood, etc., they should be treated with silicone grease.

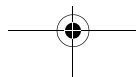

Additional equipment (For regions where snow is encountered)

It is a good idea to carry a shovel or a short-handled spade in the vehicle during the winter so that you can clear away snow if you get stranded. A small hand-brush for sweeping snow off the vehicle and a plastic scraper for the windshield, side and rear window are also useful.

Fusible links

N00942700259

The fusible links will melt to prevent a fire if a large current attempts to flow through certain electrical systems.

In case of a melted fusible link, see your authorized Mitsubishi Motors dealer or a repair facility of your choice for inspection and replacement.

For the fusible links, please refer to “Fuse load capacities” on page 9-30.

⚠ WARNING

- **Fusible links must not be replaced by any other device. Failing to fit the correct fusible link may result in fire in the vehicle, property destruction and serious or fatal injuries at any time.**

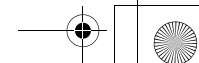
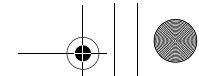

Fuses

N00942800801

Fuse block location

To prevent damage to the electrical system from short-circuiting or overloading, each individual circuit is equipped with a fuse. The fuse blocks are located in the passenger compartment and in the engine compartment.

Passenger compartment

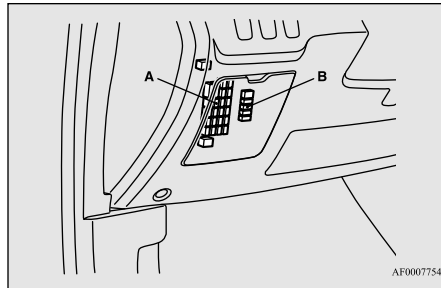

- A- Main fuse block
- B- Sub fuse block

The fuse blocks in the passenger compartment are located behind the fuse lid on the driver's side as shown.

1. Open the fuse lid and pull to remove it.

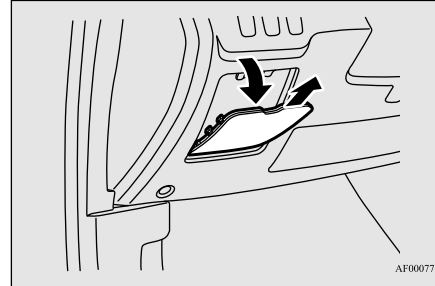

2. For vehicles with the bottom cover, use the puller to loosen the 2 clips (A) and push down the bottom cover. The puller is in the fuse block in the engine compartment. Refer to "Fuse replacement" on page 9-33.

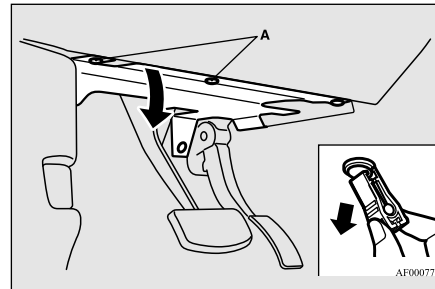

WARNING

- When changing fuses, do not damage the driver's knee airbag harness or accidentally strike the airbag area with hard objects. Improper work methods could result in an accidental driver's knee airbag deployment or could make the driver's knee airbag inoperable. Either of these situations could result in serious injury or death.

NOTE

- When finished, be sure to return the puller to the fuse block in the engine compartment.

3. To put back the fuse lid, line up the fuse lid hook (B) with the clamp (C) on the instrument panel and push the lid back in.

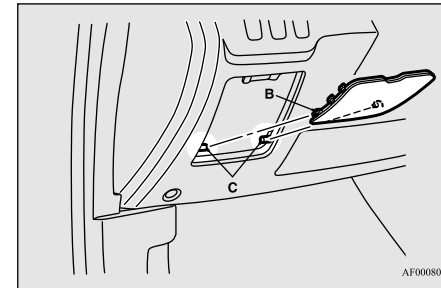

Fuses

Engine compartment

In the engine compartment, the fuse block is located as shown in the illustration.

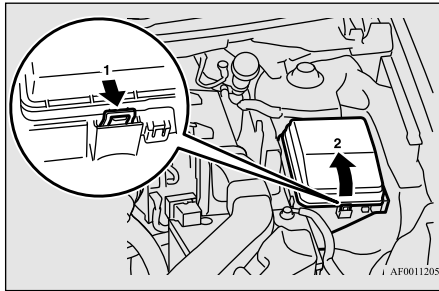

9

1. Push the lock lever.
2. Remove the fuse block cover.

Fuse load capacities

N00954800231

This fuse list shows the names of the electrical systems and their fuse capacities.

There are spare fuses in the cover of the fuse block in the engine compartment. Always replace a blown fuse with one of the same capacity as the original.

Passenger compartment fuse location table

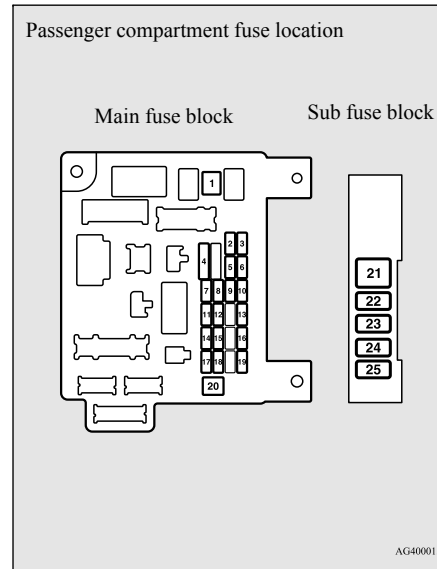

No.	Sym- bol	Electrical system	Capac- ity
1	⏏	Heater	30 A*
2	STOP	Stop lights (Brake lights)	15 A
3	⏏	Rear fog light	10 A

No.	Sym- bol	Electrical system	Capac- ity
4	⏏	Windshield wiper	30 A
5	⏏	Optional	10 A
6	⏏	Door locks	20 A
7	🎵	Radio	15 A
8	⏏	Control unit relay	7.5 A
9	☀️	Interior lights (Dome lights)	15 A
10	⚠️	Hazard warning flasher	15 A
11	⏏	Rear window wiper	15 A
12	📊	Gauges	7.5 A
13	🚬	Cigarette lighter/Accessory socket	15 A
14	🔑	Ignition switch	10 A
15	☀️	Sunroof	20 A
16	📺	Outside rearview mirrors	10 A
17	🚗	All-wheel drive sys- tem	10 A
18	⏏	Back-up lights	7.5 A
19	⏏	Accessory socket	15 A

Fuses

No.	Symbol	Electrical system	Capacity
20		Power window control	30 A*
21		Defogger	30 A*
22		Heated outside rearview mirrors	7.5 A
23		115V Power outlet	15 A
24		Power seats	25 (20) A
25		Heated seats	30 A

*- Fusible link

- Some fuses may not be installed on your vehicle, depending on the vehicle model or specifications.
- The table above shows the main equipment corresponding to each fuse.

Engine compartment fuse location table

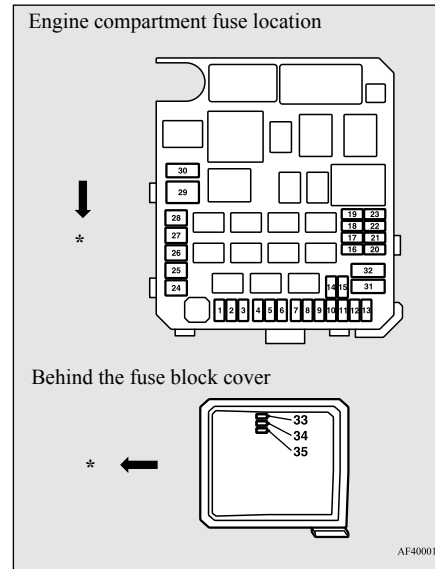

*- Front of the vehicle

No.	Symbol	Electrical system	Capacity
1		Front fog lights	15 A
2		Engine	7.5 A

No.	Symbol	Electrical system	Capacity
3		Automatic transaxle	20 A
4		Horn	10 A
5		Alternator	7.5 A
6		Headlight washer	20 A
7		Air conditioning	10 A
8		ETV/Oil cooler fan (Twin Clutch SST)	Except for vehicles with turbocharger 15 A
		ETV	Vehicles with turbocharger
9		Security horn	20 A
10		Wiper deicer	15 A
11	—	—	—
12		Power gate	30 A
13		Daytime running lights	10 A
14		Headlight (high beam) (left)	10 A
15		Headlight (high beam) (right)	10 A

Fuses

No.	Symbol	Electrical system		Capacity
16		Headlight (low/high beam) (left)	Discharge	20 A
17		Headlight (low/high beam) (right)	Discharge	20 A
18		Headlight (low beam) (left)	Halogen	10 A
19		Headlight (low beam) (right)	Halogen	10 A
20		ENG/POWER	Except for vehicles with turbocharger	10 A
		I/C SPRAY	Vehicles with turbocharger	
21		Ignition coil		10 A

9

No.	Symbol	Electrical system		Capacity
22		ENG/POWER	Vehicles with turbocharger	20 A
		ENG/POWER	Except for vehicles with turbocharger	20 A
		Fuel line heater	Vehicles with turbocharger	25 A
23		Fuel pump	Except for vehicles with turbocharger	15 A
			Vehicles with turbocharger	20 A
24		Starter		30 A*
25		Valve lift control	Except for vehicles with turbocharger	40 A*
	—	—	Vehicles with turbocharger	—
26		Anti-lock braking system		40 A*

No.	Symbol	Electrical system	Capacity
27		Anti-lock braking system	30 A*
28		Air conditioning condenser fan motor	30 A*
29		Radiator fan motor	40 A*
30	IOD	IOD	30 A
31		Audio amplifier	30 A
32		Diesel	30 A
33	—	Spare fuse	10 A
34	—	Spare fuse	15 A
35	—	Spare fuse	20 A

*- Fusible link

- Some fuses may not be installed on your vehicle, depending on the vehicle model or specifications.
- The table above shows the main equipment corresponding to each fuse.

There are no 7.5 A, 25 A or 30 A spare fuses. If a fuse of one of these capacities blows, replace it temporarily by borrowing one of the fuses indicated below.

7.5 A: 10 A spare fuse
 25 A: 20 A spare fuse
 30 A: 30 A audio amplifier fuse

Fuses

Replace the borrowed fuse with a fuse that has the correct capacity as soon as possible.

Identification of fuse

Capacity	Color
7.5 A	Brown
10 A	Red
15 A	Blue
20 A	Yellow
25 A	Natural (White)
30 A	Green (fuse type)/Pink (fusible link type)
40 A	Green

Fuse replacement

N00954900027

1. Before replacing a fuse, always turn off the electrical item connected to the fuse and turn the ignition switch to the "LOCK" position.
2. There is a fuse puller (A) in the engine compartment fuse block.

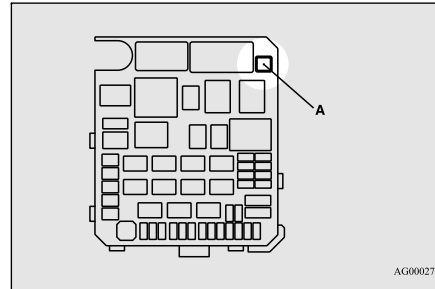

AG0002749

3. Clamp it on the fuse you wish to remove, and pull the fuse straight out from the fuse block.

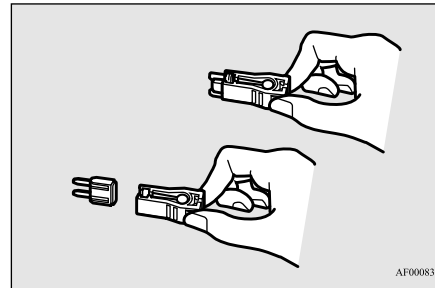

AF0008315

4. Use the fuse location diagrams and the matching tables, to check the fuse that is related to the problem. If the fuse is not blown, something else must be causing the problem. Contact an authorized Mitsubishi Motors dealer or a repair facility of your choice to have the problem checked.

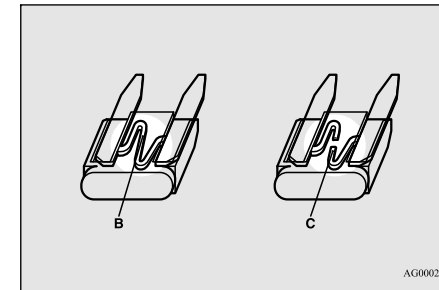

AG0002765

- B- Fuse is OK
C- Blown fuse

5. Insert a new fuse of the same capacity securely into the appropriate slot.

CAUTION

- Never use a fuse with a capacity greater than the one listed or any substitute, such as wire, foil etc. This would cause the circuit wiring to heat up and could cause a fire.

Replacement of light bulbs

⚠ CAUTION

- If the replacement fuse blows again after a short time, have the electrical system checked by an authorized Mitsubishi Motors dealer or a repair facility of your choice to find and correct the cause.

Replacement of light bulbs

N00942900219

Before replacing a bulb, be sure the light is off. Do not touch the glass part of the new bulb with your bare fingers; the oil from your skin will stay on the glass and dim or destroy the bulb when it gets hot.

9

⚠ CAUTION

- Bulbs are extremely hot immediately after being turned off.
When replacing a bulb, wait for it to cool sufficiently before touching it. You could otherwise be burned.

📖 NOTE

- If you are unsure of how to carry out the work as required, it is recommended that these procedures be carried out by an authorized Mitsubishi Motors dealer or a repair facility of your choice.
- Be careful not to scratch the vehicle body when removing a light and lens.

📖 NOTE

- When it rains, or when the vehicle has been washed, the inside of the lens sometimes becomes temporarily foggy. This is the same phenomenon as when window glass mists up on a humid day, and does not indicate a functional problem.
When the light is switched on, the heat will remove the fog. However, if water gathers inside the light, please have it checked by an authorized Mitsubishi Motors dealer or a repair facility of your choice.

Bulb capacity

N00943000099

The bulb should only be replaced with a new bulb with the same rating and type. The type and rating are listed on the base of the bulb.

Outside

N00950301932

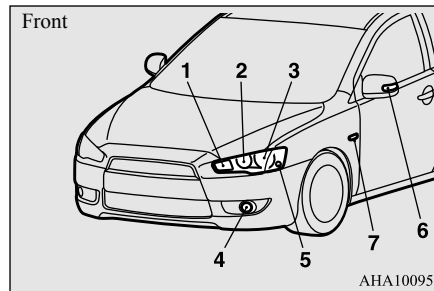

AHA100953

[Except for vehicles with high intensity discharge headlights]

Description	Wattage	ANSI Trade No. or Bulb type
1- Front turn signal light	21 W	WY21W
2- Head light, high beam	60 W	9005 HB3
3- Head light, low beam/Daytime running light (if so equipped) (Halogen bulb)	51 W	9006 HB4
4- Front fog light (if so equipped)	55 W	H11
5- Front side-marker and parking light	5 W	W5W
6- Side turn signal light (on outside rear-view mirror) (If so equipped)	—	—
7- Side turn signal light (on fender) (If so equipped)	5 W	—

Replacement of light bulbs

[For vehicles with high intensity discharge headlights]

Description	Wattage or Candle power	ANSI Trade No. or Bulb type
1- Front turn signal light	21 W	WY21W
2- Daytime running light	27 W 32 cp	1156
3- Head light, low/high beam (Discharge bulb)	35 W	—
4- Front fog light	55 W	H11
5- Front side-marker and parking light	5 W	WY5W
6- Side turn signal light (on outside rear-view mirror)	—	—

WARNING

● Check with an authorized Mitsubishi Motors dealer or a repair facility of your choice when it is necessary to repair a discharge headlight or to replace the bulb. The power circuit, bulb and electrodes generate high voltages that may cause a severe electrical shock.

NOTE

- The side turn signal light (on outside rear-view mirror) uses LEDs rather than bulbs. For repair and replacement, contact an authorized Mitsubishi Motors dealer or a repair facility of your choice.
- It is not possible to repair or replace only the bulb for the side turn signal light (on fender). Check with an authorized Mitsubishi Motors dealer or a repair facility of your choice when the light needs to be repaired or replaced.

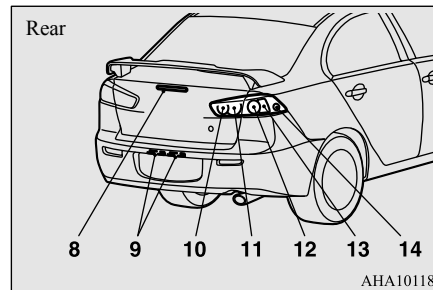

Description	Wattage	ANSI Trade No. or Bulb type
8- High-mounted stop light	—	—
9- License plate light	5 W	W5W
10- Back-up light	21 W	7440
11- Tail light	5 W	W5W
12- Tail and stop light	21/5 W	7443
13- Rear turn signal light	21 W	7440
14- Rear side-marker light	5 W	W5W

NOTE

- The high-mounted stop light uses LEDs rather than bulbs. For repair and replacement, contact an authorized Mitsubishi Motors dealer or a repair facility of your choice.

Replacement of light bulbs

Inside

N00950400460

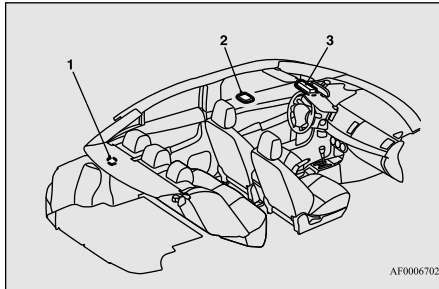

AF0006702

9

Description	Wattage
1- Trunk area light	5 W
2- Dome light (rear) (if so equipped)	8 W
Dome light (front)/ 3- Reading light (if so equipped)	8 W

Headlights (low beam, except for vehicles with high intensity discharge headlights)

N00943100872

1. For vehicles equipped with turbocharger, when replacing the bulb on the driver's side, remove the bolt (A) holding down the relay box and move the relay box toward the rear of the vehicle.

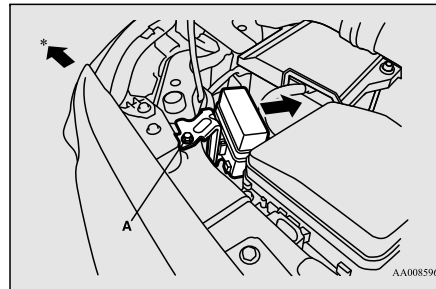

AA0085964

*- Front of the vehicle

2. For vehicles equipped with turbocharger, when replacing the bulb on the passenger's side, lift up the engine coolant reservoir (B).

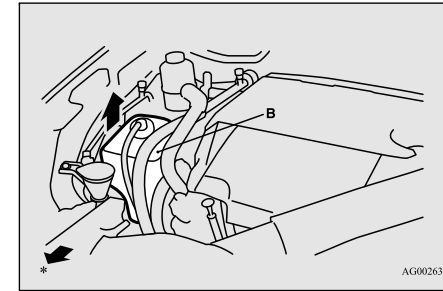

AG0026349

*- Front of the vehicle

3. Turn the bulb (C) counterclockwise, and then remove the headlight bulb with holder.

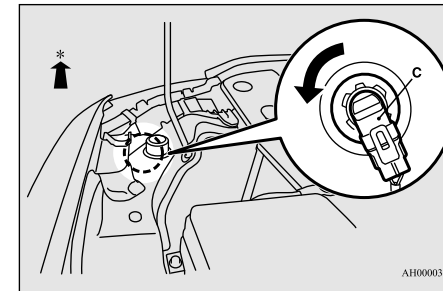

AH0000344

*- Front of the vehicle

4. While holding down the tab (D), pull out the bulb (E).

Replacement of light bulbs

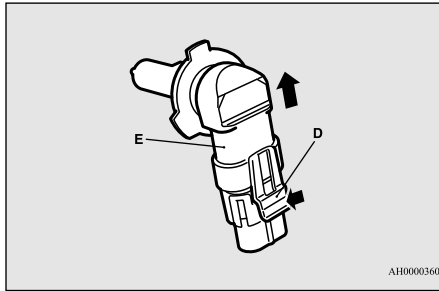

5. To install the bulb, perform the removal steps in reverse.

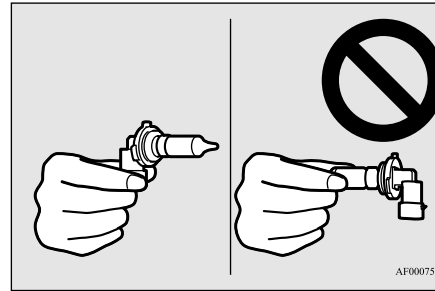

Headlights (high beam, except for vehicles with high intensity discharge headlights)

N00943100885

1. When replacing the bulb on the front passenger's side, remove the bolt (A) holding down the washer tank spout and move the spout toward the rear of the vehicle.

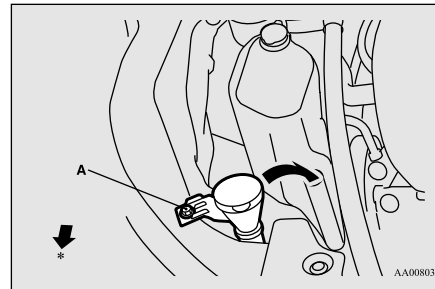

*- Front of the vehicle

2. Turn the cap (B) counterclockwise to remove it.

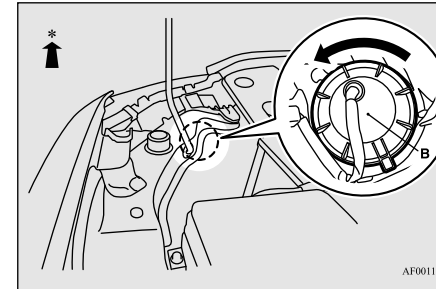

*- Front of the vehicle

3. Turn the bulb (C) counterclockwise to remove it.

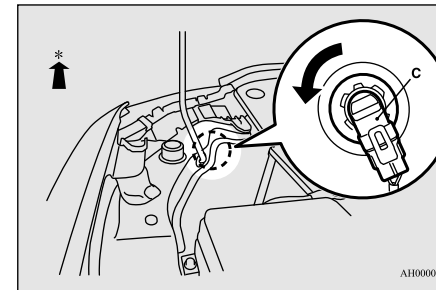

*- Front of the vehicle

4. While holding down the tab (D), pull out the bulb (E).

CAUTION

- Handle halogen light bulb with care. The gas inside a halogen light bulb is highly pressurized, so dropping, knocking, or scratching a halogen light bulb can cause it to shatter.
- Never hold the halogen light bulb with a bare hand, dirty glove, etc. The oil from your hand could cause the bulb to break the next time the headlights are used. If the glass surface is dirty, clean it with alcohol and let it dry completely before installing the bulb.

Replacement of light bulbs

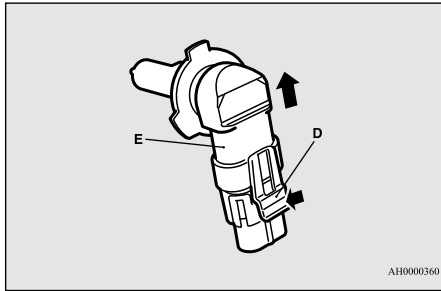

5. To install the bulb, perform the removal steps in reverse.

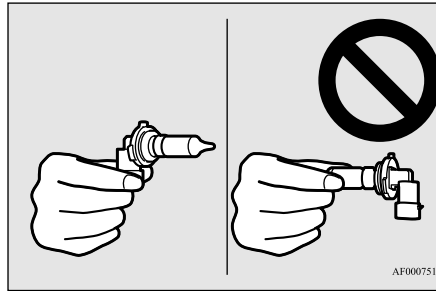

Daytime running lights (for vehicles with high intensity discharge headlights)

N00900300103

1. When replacing the bulb on the front passenger's side, remove the bolt (A) holding down the washer tank spout and move the spout toward the rear of the vehicle.

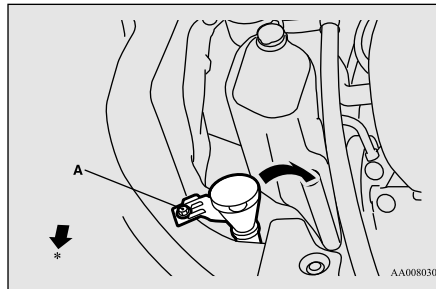

*- Front of the vehicle

2. Turn the cap (B) counterclockwise to remove it.

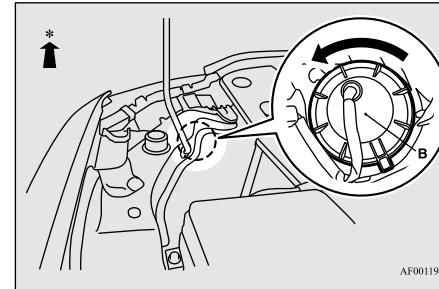

*- Front of the vehicle

3. Turn the socket (C) counterclockwise to remove it.

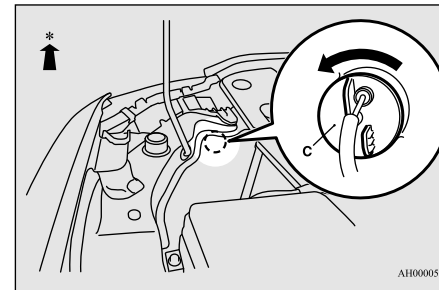

*- Front of the vehicle

4. Turn the bulb counterclockwise while pressing it and pull it out of the socket.

9

CAUTION

- Handle halogen light bulb with care. The gas inside a halogen light bulb is highly pressurized, so dropping, knocking, or scratching a halogen light bulb can cause it to shatter.
- Never hold the halogen light bulb with a bare hand, dirty glove, etc. The oil from your hand could cause the bulb to break the next time the headlights are used. If the glass surface is dirty, clean it with alcohol and let it dry completely before installing the bulb.

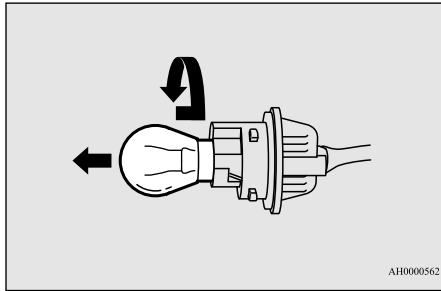

5. To install a bulb, perform the removal steps in reverse.

Headlights (low/high beam, for vehicles with high intensity discharge lights)

N00943100625

Do not attempt to disassemble or repair headlights, and do not attempt to replace their bulbs.

⚠ WARNING

- A high voltage is present in the power circuit and in the bulbs and bulb terminals. To avoid the risk of an electric shock, contact an authorized Mitsubishi dealer whenever repair or replacement is necessary.

Adjustment of headlight aim

N00943200121

The alignment of the headlights should be checked by an authorized Mitsubishi Motors dealer or a repair facility of your choice.

Parking and side-marker lights (except for vehicles with high intensity discharge headlights)

N00917300512

1. For vehicles equipped with turbocharger, when replacing the bulb on the driver's side, remove the bolt (A) holding down the relay box and move the relay box toward the rear of the vehicle.

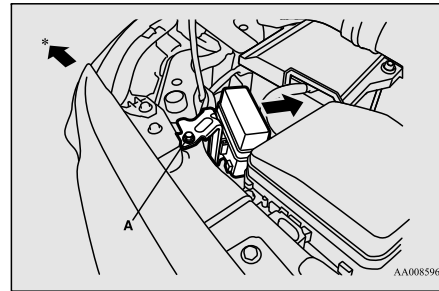

*- Front of the vehicle

Replacement of light bulbs

2. For vehicles equipped with turbocharger, when replacing the bulb on the passenger's side, lift up the engine coolant reservoir (B).

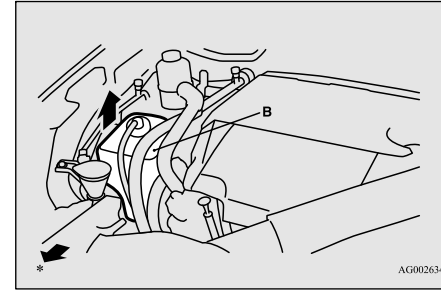

*- Front of the vehicle

3. Turn the socket (C) counterclockwise to remove it.

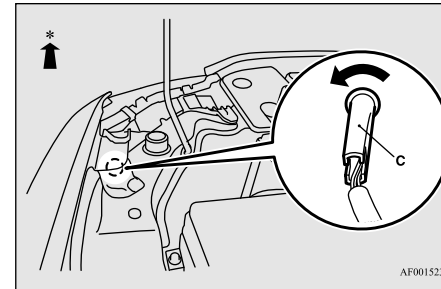

*- Front of the vehicle

4. Pull the bulb out of the socket.

Replacement of light bulbs

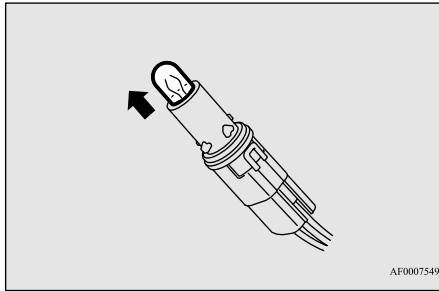

5. To install the bulb, perform the removal steps in reverse.

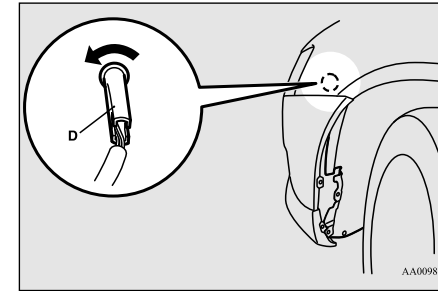
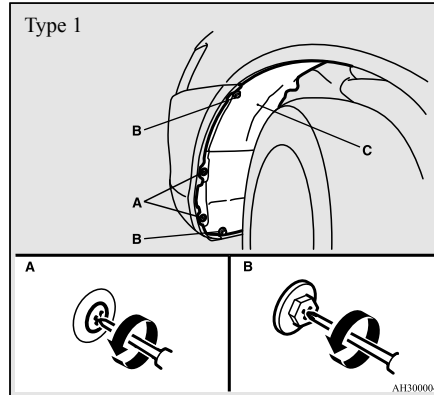

4. Pull the bulb out of the socket.

9 Parking and side-marker lights (for vehicles with high intensity discharge headlights)

N00917300538

1. To create enough work space, turn the steering wheel all the way in the direction opposite to the side you wish to replace.
2. Remove the clips (A), and screws (B) or bolts (B) to turn up the cover (C).

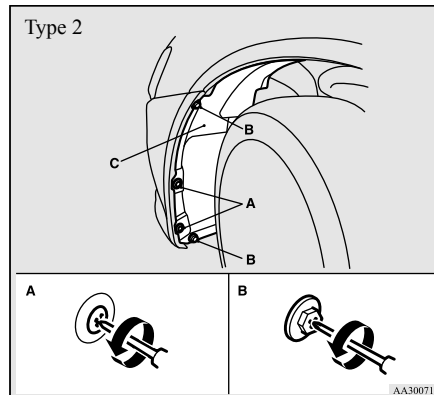

3. Turn the socket (D) counterclockwise to remove it.

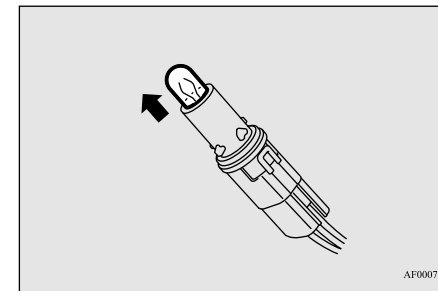

5. To install the bulb, perform the removal steps in reverse.

Front turn signal lights

N00943400325

1. Remove the clips (A) and clips (B), then remove the duct (C) and the upper cover (D).

Replacement of light bulbs

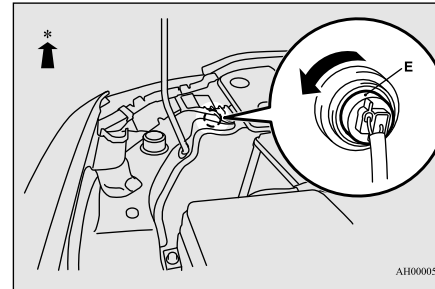
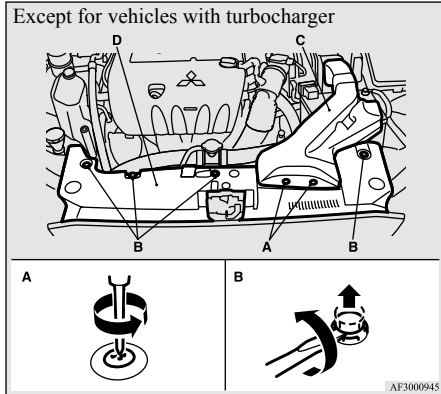

*- Front of the vehicle

3. Remove the bulb by pulling it out.

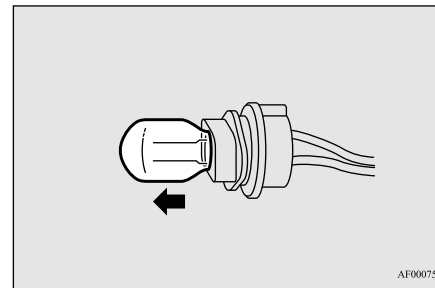

4. To install the bulb, perform the removal steps in reverse.

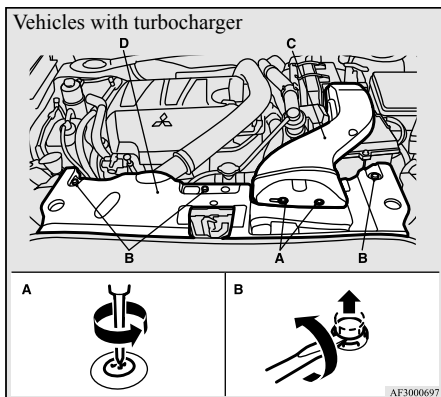

Front fog lights (Type 1) (if so equipped)

N00943601786

1. Remove the screw (A) and pull the cover out.

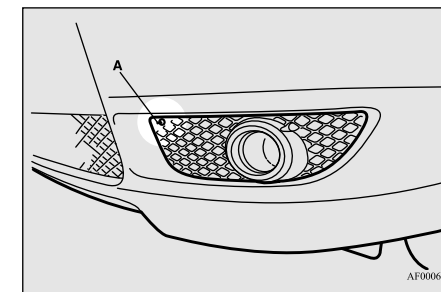

9

2. Remove the screws (B) and pull the entire light unit out.

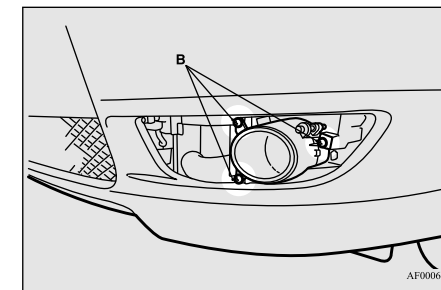

2. Remove the entire socket and bulb assembly (E) by turning it counterclockwise.

Replacement of light bulbs

NOTE

- When unfastening the screws, be careful not to mistakenly move the beam position adjustment screw (C).

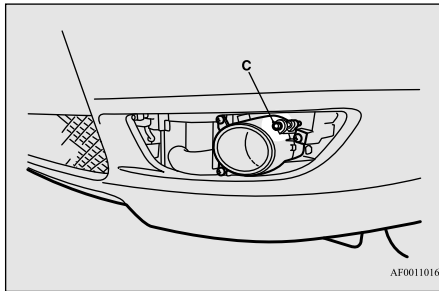

9

3. Push the connector (D) to disconnect and remove the fog light.

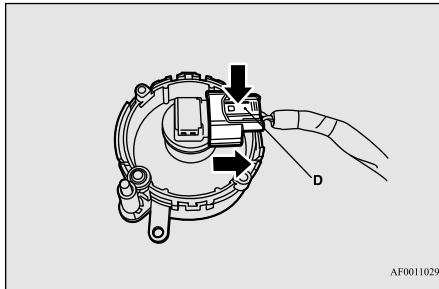

4. Remove the bulb assembly (E) by turning it counterclockwise.

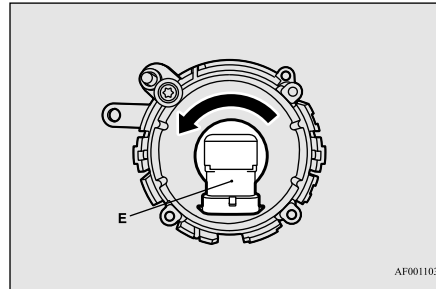

5. To install the bulb, perform the removal steps in reverse.

NOTE

- When mounting the cover, align the hooks (F) on the cover with the hole in the body.

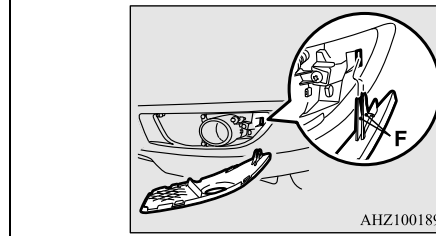

CAUTION

- Handle halogen light bulbs with care. The gas inside a halogen light bulb is highly pressurized, so dropping, knocking, or scratching a halogen light bulb can cause it to shatter.

CAUTION

- Never hold the halogen light bulb with a bare hand, dirty glove, etc. The oil from your hand could cause the bulb to break the next time the fog lights are used. If the glass surface is dirty, clean it with alcohol and let it dry completely before installing the bulb.

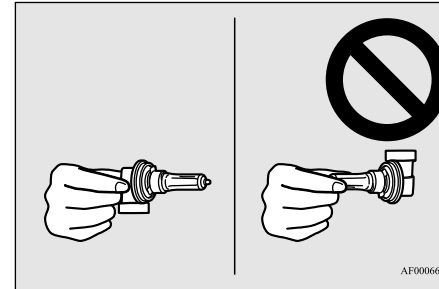

Front fog lights (Type 2) (if so equipped)

N00943601799

1. Remove the screw (A).

Replacement of light bulbs

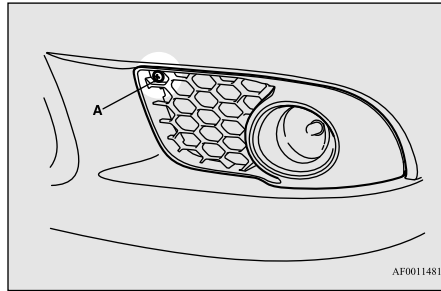

2. Pull the cover out in the direction of the arrow shown in the illustration.

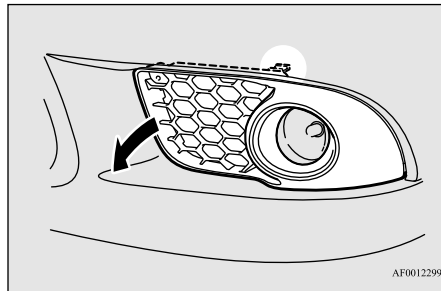

3. Remove the screws (B) and pull the entire light unit out.

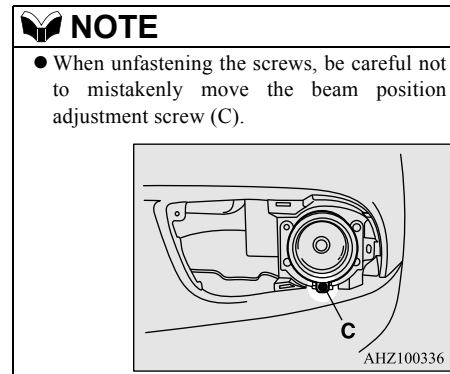
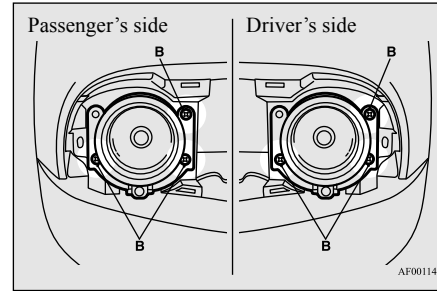

4. Push the connector (D) to disconnect and remove the fog light.

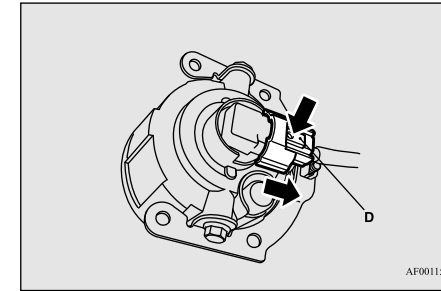

5. Remove the bulb assembly (E) by turning it counterclockwise.

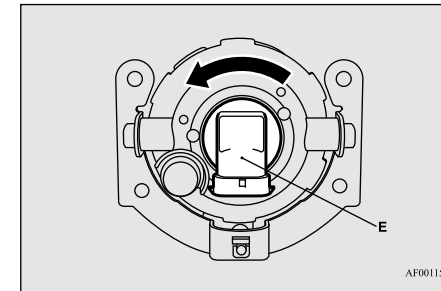

6. To install the bulb, perform the removal steps in reverse.

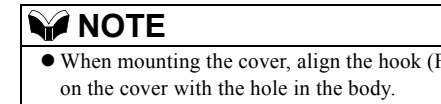

9

Replacement of light bulbs

NOTE

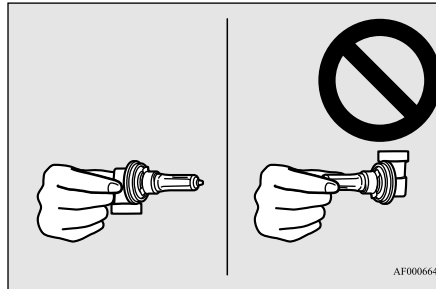
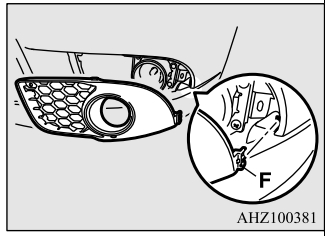

2. Remove the light unit in the rear direction.

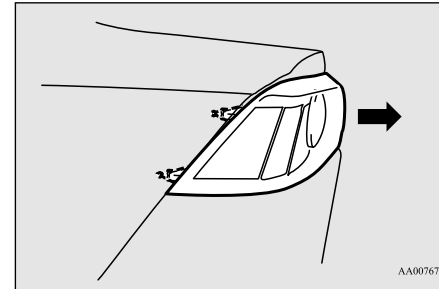

CAUTION

- Handle halogen light bulbs with care. The gas inside a halogen light bulb is highly pressurized, so dropping, knocking, or scratching a halogen light bulb can cause it to shatter.
- Never hold the halogen light bulb with a bare hand, dirty glove, etc. The oil from your hand could cause the bulb to break the next time the fog lights are used. If the glass surface is dirty, clean it with alcohol and let it dry completely before installing the bulb.

Rear combination lights

N00943701514

Tail and stop lights, rear turn signal lights and rear side-marker lights

1. Remove the screws (A) from the light unit.

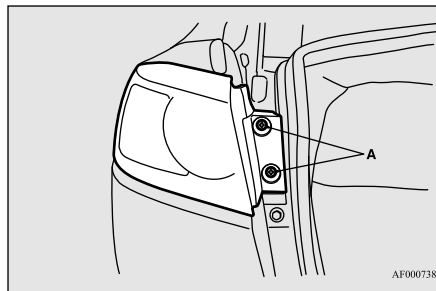

3. Remove the socket and bulb assemblies by turning them counterclockwise.

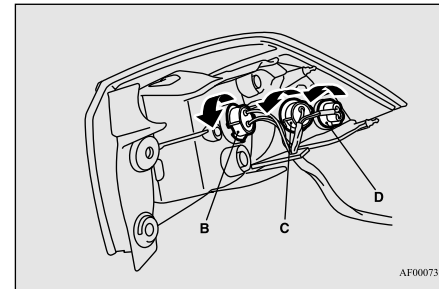

- B- Tail and stop light
- C- Rear turn signal light
- D- Rear side-marker light

4. Remove the bulb by pulling it out.

Replacement of light bulbs

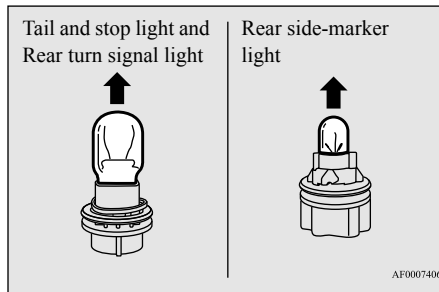

5. To install the bulb, perform the removal steps in reverse.

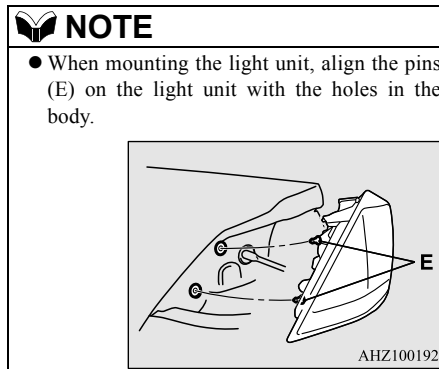

Tail lights and back-up lights

1. Open the trunk lid.

Remove the clips (A) and remove the cover (B).

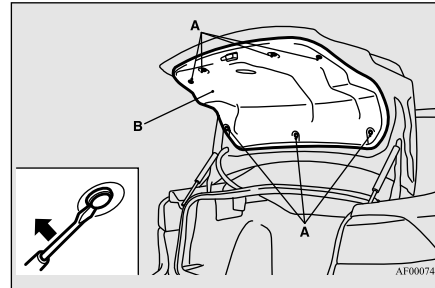

2. Remove the socket and bulb assemblies by turning them counterclockwise.

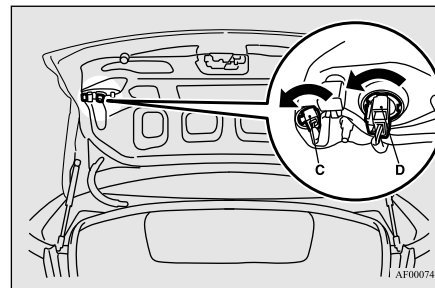

C- Tail light
D- Back-up light

3. Remove the bulb by pulling it out.

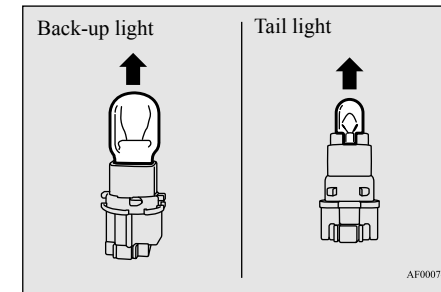

4. To install the bulb, perform the removal steps in reverse.

License plate light

9

1. Remove the screws (A) from the license plate light lens (B). Then, remove the lens and gasket (C), and withdraw the bulb.

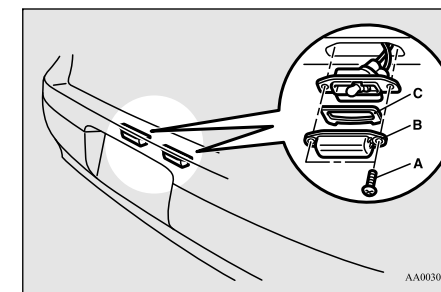

2. Remove the socket and bulb assembly together by turning it counterclockwise.

Vehicle care and maintenance 9-45

Replacement of light bulbs

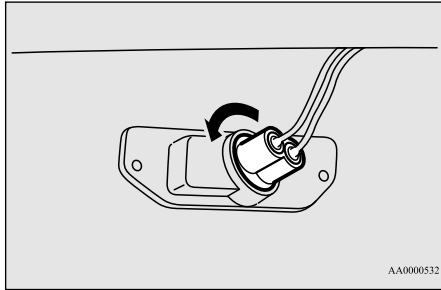

3. Remove the bulb by pulling it out.

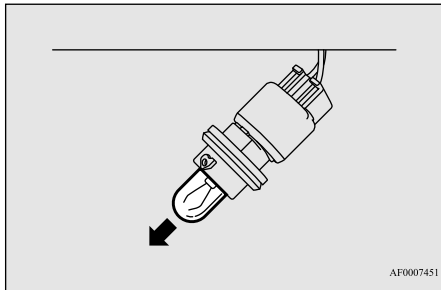

4. To install the bulb, perform the removal steps in reverse.

Dome light (front)/Reading lights (if so equipped)

N00944500206

1. Insert a screwdriver into the notch of the light assembly. Gently pry to remove the lens.

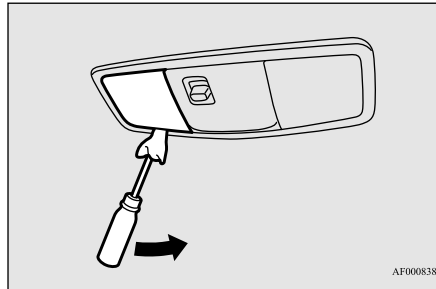

NOTE

- Wrap a cloth around the tip of the screwdriver to keep from scratching the lens.

2. While holding down the tab (A), pull out the bulb.

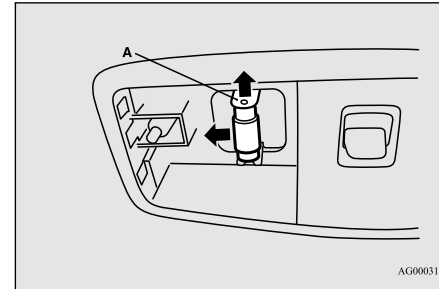

3. To install the bulb, perform the removal steps in reverse.

NOTE

- Before replacing the bulb, put the dome light (front)/reading lights switch into the “OFF” position.
- When mounting the lens, align the tab (B) with the hole on the vehicle body.

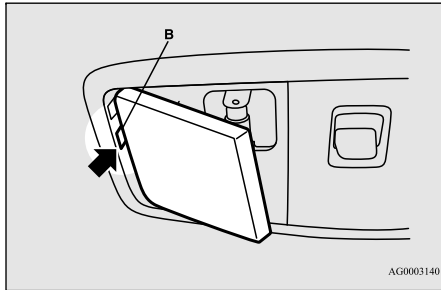

Dome light (rear) (if so equipped)

N00944100260

1. Insert a screwdriver into the notch of the light assembly and pry gently to remove the lens.

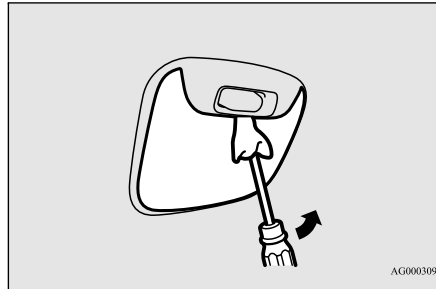

NOTE

- Wrap a cloth around the tip of the screwdriver to keep from scratching the lens.

Replacement of light bulbs

2. While holding down the tab (A), pull out the bulb.

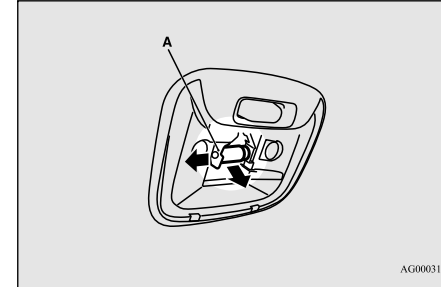

3. To install the bulb, perform the removal steps in reverse.

NOTE

- Before replacing the bulb, put the dome light (rear) switch into the “OFF” position.
- When mounting the lens, align the tab (B) with the hole on the vehicle body.

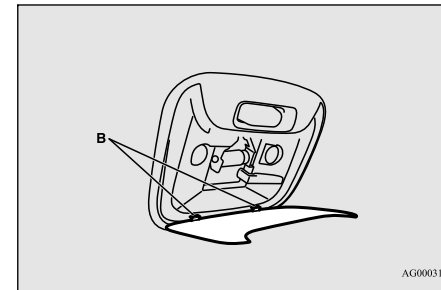

Vehicle care precautions

Trunk area light

N0094480094

1. Pull both clips (A) away from the center as shown and remove the light unit. Then remove the bulb by pulling out.

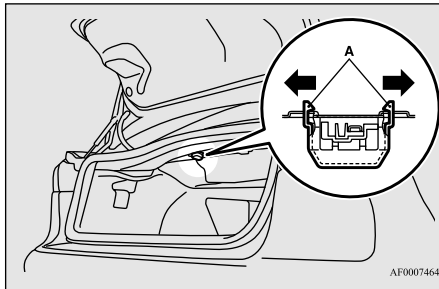

AF0007464

9

2. To install the bulb, perform the removal steps in reverse.

Vehicle care precautions

N00945100153

In order to maintain the value of your vehicle, perform regular maintenance using the proper materials and procedures. Be sure to use only those materials and procedures that meet your local environmental pollution control regulations. Choose the materials you will use carefully, to be sure that they do not contain corrosives. If you are not sure, contact an authorized Mitsubishi Motors dealer for help in choosing these materials.

9-48 Vehicle care and maintenance

CAUTION

● Cleaning products can be dangerous. Some are poisonous. Others are highly flammable. Some are dangerous if you breathe their fumes in a closed space. When you use anything in a container to clean your vehicle, be sure to follow the instructions. Always open your vehicle doors or windows when you're cleaning the inside. Never use the following chemicals to clean your vehicle:

- Gasoline
- Carbon Tetrachloride
- Benzine
- Kerosene
- Naphtha
- Acetone
- Turpentine
- Paint Thinner
- Lacquer Thinner
- Nail Polish Remover

These can all be dangerous, and they all can damage your vehicle.

Cleaning the inside of your vehicle

N00945200079

After washing the inside of your vehicle with any cleaner, wipe it dry in a shady, well ventilated area.

CAUTION

- Do not use organic substances (solvents, benzine, kerosene, alcohol, gasoline, etc.) or alkaline or acidic solutions. These chemicals can cause discoloring, staining or cracking of the surface. If you use cleaners or polishing agents, make sure their ingredients do not include the substances mentioned above.

NOTE

- Always read the instructions on the cleaner label.

Plastic, vinyl leather, fabric and flocked parts

N00945300171

1. Lightly wipe these off with a soft cloth soaked in a 3 % solution of gentle soap and water.
2. Dip cloth in fresh water and wring out well. Using this cloth, wipe off the detergent thoroughly.

NOTE

- Do not use cleaners, conditioners, and protectants containing silicones or wax. Such products, when applied to the instrument panels or other parts, may cause reflections on the windshield and obscure vision. Also, if such products get on the switches of the electrical accessories, it may lead to failure of these accessories.

Upholstery

N00945500131

1. To maintain the value of your new vehicle, maintain the upholstery carefully and keep the interior clean. Use a vacuum cleaner and brush to clean the seats. If stained, vinyl and synthetic leather should be cleaned with an appropriate cleaner. Cloth fabrics can be cleaned with either upholstery cleaner or a 3 % solution of gentle soap in lukewarm water.
2. Clean the carpeting with a vacuum cleaner and remove any stains with carpet cleaner. Oil and grease can be removed by lightly dabbing with a clean white cloth and spot remover.

NOTE

- If fuzzing is difficult to remove from the seat upholstery, draw a suitable defuzzing brush over the surface in one direction.

Genuine leather (if so equipped)

N00945600161

1. To clean, lightly wipe the leather with a soft cloth soaked in a 5 % solution of gentle soap and water.
2. To rinse, dip the cloth in fresh water, wring it out well, and wipe off all the soap.
3. To preserve and protect, use a leather protecting agent on the genuine leather surface.

NOTE

- If genuine leather is wet with water, wipe it with a dry, soft cloth. If left damp, mildew may grow.
- The genuine leather surface can be damaged if brushed with a nylon or synthetic fiber brush.
- Organic solvents such as benzine, kerosene, alcohol, gasoline, acid or alkaline solvents can discolor the genuine leather surface and should not be used.
- Genuine leather seats can mildew if not kept clean. Clean up any oil stains immediately.

Cleaning the outside of your vehicle

NOTE

- The genuine leather surface may harden and shrink if it is exposed to the direct sunlight for long hours. When your vehicle is parked, place it in the shade as much as possible.
- When the temperature of the vehicle interior rises in summer, vinyl products left on the genuine leather seat may deteriorate and stick to the seat.

Cleaning the outside of your vehicle

N00945700061

To protect your vehicle's finish, wash it often and thoroughly. If desired, you may wax your vehicle using a nonabrasive automobile wax.

9

Foreign material

N00945800046

Industrial pollution, road tar, bird droppings, tree sap, insect remains, sea water and other foreign matters can damage the finish on your vehicle.

Generally, the longer any foreign material stays on the finish, the worse the damage. Wash your vehicle as soon as possible whenever the finish gets soiled.

Cleaning the outside of your vehicle

Washing

N00945900526

Chemicals contained in the dirt and dust picked up from air, rain, snow or road surfaces can damage the paint and body of your vehicle if left on.

Frequent washing and waxing is the best way to protect your vehicle from this damage.

Do not wash the vehicle in direct sunlight. Park the vehicle in the shade and spray it with water to remove dust. Next, using plenty of clean water and a car washing mitt or sponge, wash the vehicle from top to bottom.

9

Use a mild car washing soap if necessary. Rinse thoroughly and wipe dry with a chambray or soft cloth. After washing the vehicle, carefully clean the joints and flanges of the doors, hood, etc., where dirt is likely to remain.

CAUTION

- When washing the underside of your vehicle or the wheels, wear a pair of gloves to protect your hands.
- If your vehicle has rain sensor wipers, place the wiper switch lever in the "OFF" position to deactivate the rain sensor before washing the vehicle. Otherwise, the wipers will operate in the presence of water spray on the windshield and may get damaged as a result.

CAUTION

- Never spray or splash water on the electrical parts in the engine compartment. This may damage them. Be careful also when washing the underbody. Do not spray water into the engine compartment.
- Avoid automatic car washers that use rotating brushes. These brushes may scratch the paint surface and make it dull. Scratches are more noticeable on darker colored vehicles.
- Some hot water washing equipment uses high pressure and heat to clean your vehicle. This heated water may damage your vehicle's resin parts. It can flood the interior of the vehicle. Therefore, be sure of the following:
 - Keep the washing nozzle at least 20 inches (50 cm) away from the vehicle body.
 - When washing around the door glass, hold the nozzle at a distance of more than 20 inches (50 cm) and at right angles to the glass surface.
- When using high-pressure water to wash a vehicle equipped with the F.A.S.T.-key system, keep the water from spraying on the open button on the trunk. This could cause the trunk to open and flood the inside of the trunk.
- Make sure to do the following when using an automatic car wash, with help from either this manual or the car wash operator, to avoid damaging your vehicle:
 - Fold the outside mirrors.

CAUTION

- Put down (except for vehicles with SIRIUS satellite radio antenna) or remove the antenna.
- If your vehicle is equipped with rear spoiler, check with the car wash operator before using the car wash.
- If your vehicle has rain sensor wipers, place the wiper switch lever in the "OFF" position to deactivate the rain sensor.

During cold weather

Salt and other chemicals spread on winter roads in some geographical areas can have a detrimental effect on the vehicle underbody. You should flush the underbody with a high pressure hose every time you wash the outside of your vehicle.

Take special care to remove mud or other debris which could trap and hold salt and moisture.

After washing your vehicle, wipe off all waterdrops from the rubber parts around the doors to prevent the doors from freezing.

Cleaning the outside of your vehicle

NOTE

- When the door is frozen, opening it by force may tear off or crack the rubber gasket installed around the door. Pour warm water to melt the ice. Be sure to thoroughly wipe off the water after opening the door. To prevent freezing of the weatherstripping on the doors, hood, etc., treat with silicone lubricant.

Waxing

N0094600188

Wax your vehicle once or twice a year, or when water does not bead up on the paint.

Use a soft cloth to put a small amount of wax on the painted surfaces. After the wax has dried, polish with a dry soft cloth.

Do not wax your vehicle in direct sunlight.

You should wax when the painted surfaces are cool.

CAUTION

- Waxes containing high abrasive compounds should not be used. These waxes remove rust and stain effectively from the paintwork, but are harmful to the finish on the paint and the plate, because they also remove clearcoat. They are also harmful to other glossy surfaces such as the grille, trim, moldings, etc.

CAUTION

- Do not use gasoline, kerosene, benzine or paint thinners to remove road tar or other dirt from the vehicle surface.
- Do not put wax on the areas having black matte coating because it can cause uneven discoloration, patches, blurs, etc. If these get wax on them, wipe the wax off right away with a soft cloth and warm water.
- On vehicles with sunroof, be careful not to apply any wax on the weatherstrip (black rubber) when waxing the area around the sunroof opening.
If stained with wax, the weatherstrip cannot maintain a weatherproof seal with the sunroof.

Polishing

N00946100059

If painted surfaces have been severely damaged and lost their original luster and color tone, polish the surface lightly with a fine polishing compound. Avoid limiting your polishing to the damaged surface only; polish a somewhat wider area, moving the polishing cloth in one direction. After polishing, flush the compound from the surface and apply a coat of wax to regain a beautiful luster.

Damaged paint

N00946200063

Small cracks and scratches in the paint coat should be touched up as soon as possible with touch-up paint to prevent corrosion.

Check body areas facing the road or the tires carefully for damage to the paint caused by flying stones, etc. The paint code number for your vehicle can be found on the vehicle information code plate in the engine compartment.

Cleaning plastic parts

N00946300178

9

Use a sponge or chamois to clean these parts. If a vehicle wax sticks to a gray or black rough surface of the bumper, molding or lights, the surface may appear white in color. In this case, wipe it off using lukewarm water and a soft cloth or chamois.

CAUTION

- Do not use a scrubbing brush or other rough scrubber as these may damage the plastic surface.
- Do not use wax containing compounds (polishing powder) which may damage the plastic surface.

Cleaning the outside of your vehicle

CAUTION

- Do not let the plastic parts get soiled with gasoline, oil, brake fluids, engine oils, greases, paint thinner, and sulfuric acid (battery electrolyte). These fluids, etc., may crack, stain or discolor the plastic parts. If any of these get on the plastic parts, wipe them up with a soft cloth or chamois and a mild solution of soap and water. Then rinse them immediately with water.

Chrome parts

N00946400065

9

To prevent spots and corrosion of chrome parts, wash with water, dry thoroughly, and apply a nonabrasive automotive wax. If the chrome is severely damaged or pitted, use a commercially available chrome polish.

Aluminum wheels (if so equipped)

N00946500196

1. Remove dirt using a wet sponge.
2. Use a mild detergent on any dirt that cannot be removed easily with water. Rinse off the detergent after washing the wheel.
3. Dry the wheel thoroughly using a chamois leather or a soft cloth.

CAUTION

- Do not use a brush or other hard implement on the wheels. Doing so could scratch the wheels.
- Do not use any cleaner that contains an abrasive substance or is acidic or alkaline. Doing so could cause the coating on the wheels to peel or become discolored or stained.
- Do not directly apply hot water using a steam cleaner or by any other means.
- Contact with seawater or road salt used for de-icing can cause corrosion. Rinse off such substances as soon as possible.

Window glass

N00946600067

The window glass can usually be cleaned using only a sponge and water. Glass cleaner can be used to remove wax, oil, grease, dead insects, etc. After washing the glass, wipe it dry with a clean, dry, soft cloth.

Wiper blades

N00946700097

Use a soft cloth and glass cleaner to remove grease, dead insects, etc., from the wiper blades.

Replace the wiper blades when they no longer clean the windshield and rear window properly.

Cleaning the sunroof (if so equipped)

N00946800072

Clean the inside of the sunroof with a soft cloth. Hard deposits should be wiped away with a cloth dipped in warm, neutral detergent solution. Wipe away the solution with a sponge dipped in fresh water.

NOTE

- The surface treatment on the inside of the glass may be removed if a hard cloth or organic solvent is used.

Engine compartment

N00947000042

Never spray or splash water on the electrical components in the engine compartment, as this may cause damage.

Do not allow any nearby parts (such as plastic parts) come into contact with sulphuric acid (battery electrolyte), which may crack, stain, or discolour them.

If this occurs, wipe the parts with a soft cloth saturated with a mild detergent and water solution.

Then immediately rinse the affected parts with plenty of water.

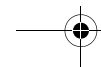
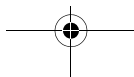
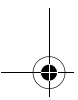
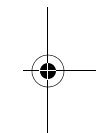
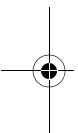
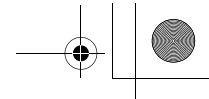

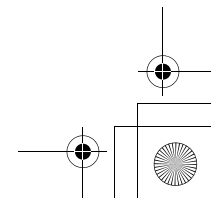
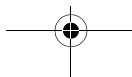
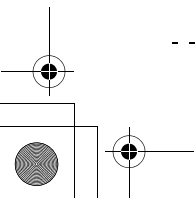
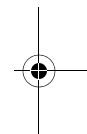
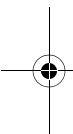
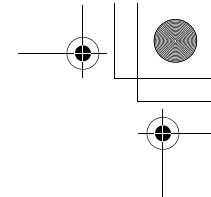
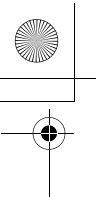

Horizontal dashed lines for text entry

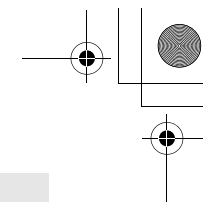

Customer assistance/Reporting Safety Defects

Consumer information (For vehicles sold in U.S.A.)	10-2
Reporting Safety Defects	10-2
Important facts to know in case of an accident	10-4

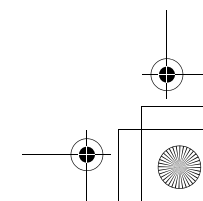
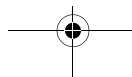
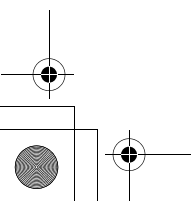
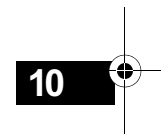
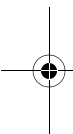



Consumer information (For vehicles sold in U.S.A.)

Consumer information (For vehicles sold in U.S.A.)

N01047100100

This information is provided in compliance with the requirements of the National Highway Traffic Safety Administration, Department of Transportation. It provides the purchasers and/or prospective purchasers with information on reporting safety defects.

Uniform tire quality grading

DOT quality grades - All passenger vehicle tires must conform to Federal Safety Requirements in addition to these grades. The specific grade rating in each grade category is shown on the side wall of the tires on your vehicle.

10

Treadwear

The treadwear grade is a comparative rating based on the wear rate of the tire when tested under controlled conditions on a specified government test course. For example, a tire graded 150 would wear one and one-half (1¹/₂) times as well on the government course as a tire graded 100. The relative performance of tires depends upon the actual conditions of



10-2 Customer assistance/Reporting Safety Defects



their use, however, and may depart significantly from the norm due to variations in driving habits, service practices and differences in road characteristics and climate.

Traction AA, A, B, C

The traction grades, from highest to lowest, are AA, A, B and C. Those grades represent the tire's ability to stop on wet pavement as measured under controlled conditions on specified government test surfaces of asphalt and concrete. A tire marked C may have poor traction performance.

WARNING

- The traction grade assigned to this tire is based on straight-ahead braking traction tests, and does not include acceleration, cornering, hydroplaning, or peak traction characteristics.

Temperature A, B, C

The temperature grades are A (the highest), B and C, representing the tire's resistance to the generation of heat and its ability to dissipate heat when tested under controlled conditions on a specified indoor laboratory test wheel. Sustained high temperature can cause the

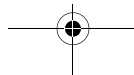

material of the tire to degenerate and reduce tire life, and excessive temperature can lead to sudden tire failure. The grade C corresponds to a level of performance which all passenger car tires must meet under the Federal Motor Vehicle Safety Standard No. 109. Grades B and A represent higher levels of performance on the laboratory test wheel than the minimum required by law.

WARNING

- The temperature grade for this tire is established for a tire that is properly inflated and not overloaded. Excessive speed, underinflation, or excessive loading, either separately or in combination, can cause heat buildup and possible tire failure.

Reporting Safety Defects

N01047201485

If you believe that your vehicle has a defect which could cause a crash or could cause injury or death, you should immediately inform the National Highway Traffic Safety Administration (NHTSA) in addition to notifying Mitsubishi Motors Corporation.

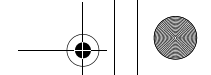

Reporting Safety Defects

If NHTSA receives similar complaints, it may open an investigation, and if it finds that a safety defect exists in a group of vehicles, it may order a recall and remedy campaign. However, NHTSA cannot become involved in individual problems between you, your dealer, or Mitsubishi Motors Corporation.

To contact NHTSA, you may call the Vehicle Safety Hotline toll-free at 1-888-327-4236 (TTY: 1-800-424-9153); go to <http://www.safercar.gov>; or write to:

**NHTSA Headquarters
1200 New Jersey Avenue, SE
West Building
Washington, DC 20590**

You can also obtain other information about motor vehicle safety from <http://www.safercar.gov>.

For vehicles sold in U.S.A.

To contact Mitsubishi Motors North America, Inc. call 1-888-648-7820 or write to:

**Mitsubishi Motors North America, Inc.
Customer Relations Department
P.O. Box 6400
Cypress, CA 90630-0064**

For vehicles sold in Canada

If you live in Canada, and you believe that your vehicle has a safety defect, you should immediately notify Transport Canada, in addition to notifying Mitsubishi Motor Sales of Canada, Inc. You may write to:

**Transport Canada
330 Sparks Street
Tower C
Ottawa, Ontario K1A 0N5**

To contact Mitsubishi Motor Sales of Canada, Inc. call 1-888-576-4878 or write to:

**Mitsubishi Motor Sales of Canada, Inc.
Customer Relations Department
P.O. Box 41009
4141 Dixie Road
Mississauga, ON L4W 5C9**

For vehicles sold in Puerto Rico

To contact Mitsubishi Motor Sales of Caribbean, Inc. call 1-787-251-8715 or write to:

**Mitsubishi Motor Sales of Caribbean, Inc.
Customer Service Department
P.O. Box 192216
SAN JUAN PR 00919-2216**

For vehicles sold in Guam

To contact Triple J Enterprises Inc.

Important facts to know in case of an accident

call (671)649-3673 or write to:

Triple J Enterprises, Inc.
P.O. Box 6066
TAMUNING
GUAM 96931

Pacific Marketing, Inc.
P.O. Box 698
PAGO PAGO,
AMERICAN SAMOA AS,
96799

Key information to discuss with your insurance company

- Understand your repair estimate before approving repairs.
- Choosing the repair shop and the brands of parts that they use on your vehicle is your decision.
- Ask for genuine Mitsubishi Motors parts. Many times, to save money, your insurance company will recommend imitation parts that do not meet the original specifications of fit, finish, corrosion resistance or workmanship.

For vehicles sold in Saipan

To contact Triple J Motors
call (670)234-7133 or write to:

Triple J Motors
P.O. Box 500487
SAIPAN, MP96950-0487

Important facts to know in case of an accident

N01047300229

We hope you will never be involved in an accident, but there is always that potential danger. So, please be sure to buckle up and drive safely.

In the event of an accident

- Remain calm.
- Check for injuries. Report all injuries to the police, and, if necessary, call for an ambulance.
- Record all the details of the accident. This will provide you with accurate records of the accident for discussions with your insurance company and other persons who may be acting on your behalf.

Mitsubishi Motors built-in protection

The strength and integrity built into your Mitsubishi vehicle is the result of a specific design referred to as "Energy Management". Individual body parts are designed to act as one unit in the event of an accident. Shock waves are absorbed by protective panels or are channeled around the passenger compartment. This important feature is possible because high tensile steel is used in Mitsubishi Motors panels and structural parts, something that cannot be guaranteed by the manufacturers of imitation parts. All Genuine Mitsubishi Motors body panels and support

For vehicles sold in American Samoa

To contact Pacific Marketing Inc.
call 684(699)9140 or write to:

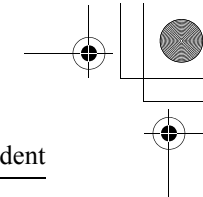

Important facts to know in case of an accident

brackets are designed and constructed as important protection features in the event of an accident. By replacing body parts with imitations, your vehicle may no longer meet original equipment specifications.

you expect. Genuine Mitsubishi Motors replacements parts are your guarantee that your vehicle will have all the technological advantages and maintain the style and protection of a brand new Mitsubishi Motors. Remember to ask for genuine Mitsubishi Motors parts.

Consumer rights (For vehicles sold in U.S.A.)

As a consumer requesting repair on your vehicle, you have consumer rights. Across the country, State Insurance Commissioners have begun considering rules on the use of non-OEM parts. This could mean that repair shops will have to disclose to the consumer, when they intend to use non-OEM parts. Since regulations are not consistent on this point, remember you have a choice. So, if you want genuine Mitsubishi Motors parts, you may have to specifically request them. Make certain your insurance company understands imitations are not to be used in the repair of your vehicle. You deserve the best genuine Mitsubishi Motors parts.

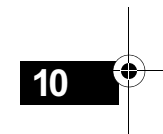
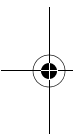

Genuine Mitsubishi Motors parts

Genuine Mitsubishi Motors parts are built with the high quality and durability standards

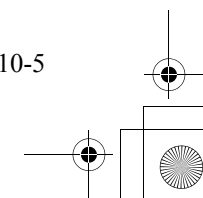
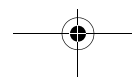
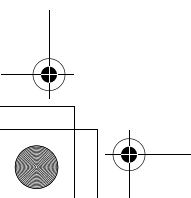

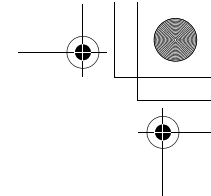
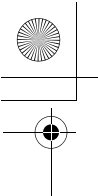

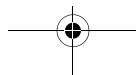
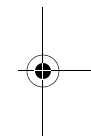
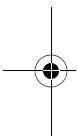

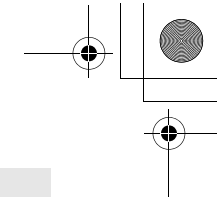

Specifications

Vehicle labeling	11-2
Vehicle dimensions	11-4
Vehicle weights	11-4
Engine specifications	11-5
Battery	11-5
Tires and wheels	11-5
Refill capacities	11-6

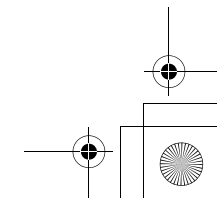
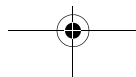
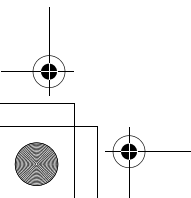
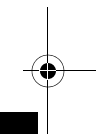
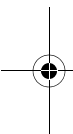

Vehicle labeling

Vehicle labeling

N01147400696

Keep a record of the chassis number and vehicle identification number. Such information will assist the police if your vehicle is stolen.

Except for vehicles with turbocharger

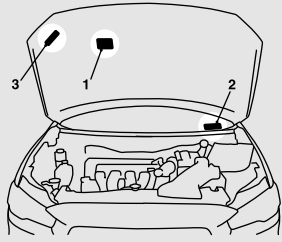

AF0012026

11

Vehicles with turbocharger

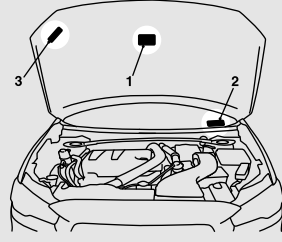

AF0012039

1 - Vehicle emission control information label

The vehicle emission control information label is affixed on the inside panel of the engine hood.

2 - Vehicle identification number plate

The vehicle identification number is stamped on the plate riveted to the left front corner of the vehicle body. It is visible from outside of the vehicle through the windshield.

3 - Air conditioning label

The air conditioning label is affixed on the inside panel of the engine compartment.

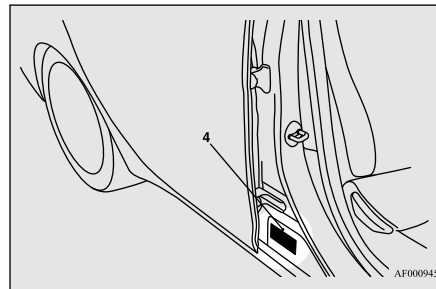

4 - Vehicle information code plate

The vehicle information code plate is located on the front passenger door sill.

Chassis number

The chassis number is stamped on the floor under the front passenger seat. It is visible by pulling back the carpet flap as shown in the illustration.

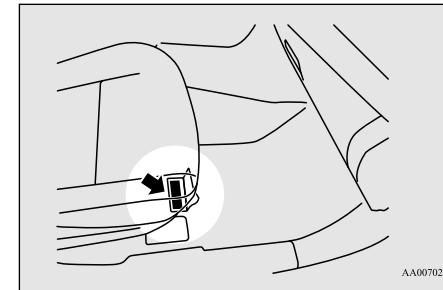

AA0070256

Engine serial number

The engine serial number is stamped on the cylinder block as shown in the illustration.

Vehicle labeling

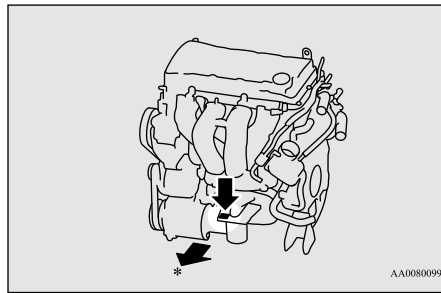

*- Front of the vehicle

Type 1

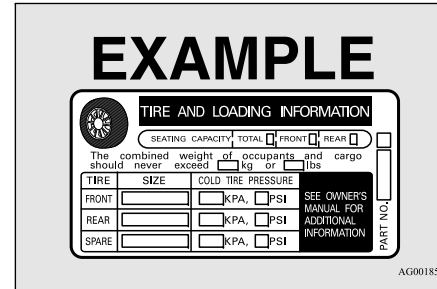

Certification label

N01148200196

The certification label (A) is located on the driver's door sill.

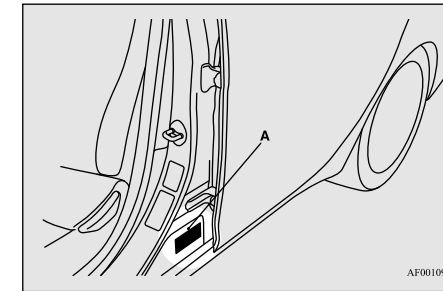

Tire and loading information placard

N01148100528

The tire and loading information placard is located on the driver's door sill.

Type 2

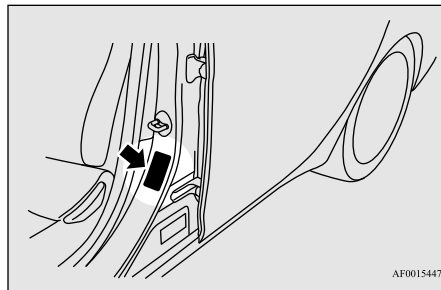
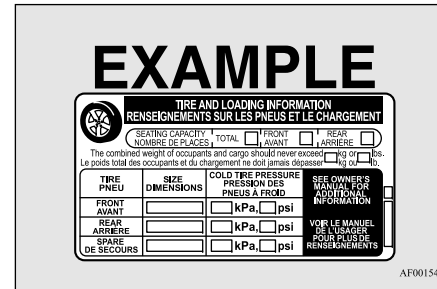

Vehicle dimensions

Vehicle dimensions

N01147500482

Item	Vehicles with 16 inch tire	Vehicles with 18 inch tire
Overall length	180.0 in (4,570 mm)	
Overall width	69.4 in (1,760 mm)	
Overall height	58.3 in (1,480 mm)	58.7 in (1,490 mm)
Wheel base	103.7 in (2,635 mm)	

Vehicle weights

N01147600890

Item	2.0 liter		2.4 liter	
	Front-wheel drive vehicles	All-wheel drive vehicles	Front-wheel drive vehicles	All-wheel drive vehicles
Gross vehicle weight rating (GVWR)	3,969 lb (1,800 kg)	4,388 lb (1,990 kg)	4,079 lb (1,850 kg)	4,190 lb (1,900 kg)
Gross axle weight rating (GAWR)	Front	2,227 lb (1,010 kg)	2,227 lb (1,010 kg)	2,227 lb (1,010 kg)
	Rear	2,007 lb (910 kg)	2,161 lb (980 kg)	2,007 lb (910 kg)
Vehicle capacity weight	827 lb (375 kg)			
Maximum roof load	110 lb (50 kg)			
Seating capacity	5 persons			

11

NOTE

- Roof load is important because it affects the vehicle capacity weight. Refer to "Loading cargo on the roof" on page 6-10.

GVWR: maximum total weight (load) limit specified for the vehicle

GAWR: maximum weight (load) limit specified for the front or rear axle

11-4 Specifications

Engine specifications

Seating capacity: the number of maximum occupants

Engine specifications

N01147700439

Item	2.0 liter		2.4 liter
	Except for vehicles with turbocharger	Vehicles with turbocharger	
Engine model	4B11		4B12
Engine displacement	121.9 CID (1,998 cm ³)		144.0 CID (2,360 cm ³)
No. of cylinders and cylinder arrangement	4 in-line		
Bore	3.39 in (86.0 mm)		3.46 in (88.0 mm)
Stroke	3.39 in (86.0 mm)		3.82 in (97.0 mm)
Compression ratio	10.0	9.0	10.5
Thermostat valve opening temperature	189 °F (87 °C)	180 °F (82 °C)	189 °F (87 °C)
Spark plugs	NGK DIFR6C11	DILKR7B6	DIFR5C11
Spark plug gap	.040 to .043 in (1.0 to 1.1 mm)	.020 to .023 in (0.5 to 0.6 mm)	.040 to .043 in (1.0 to 1.1 mm)
Firing order	1-3-4-2		

11

Battery

N01147800182

75D23L

Battery is a 12 volt type.

Tires and wheels

N01147901786

Tire	Size		
	P205/60R16 91H	215/45R18 89W, P215/45R18 89V	

Wheel	Size	16 x 6 1/2J, 16 x 6 1/2JJ	18 x 7J
	PCD	4.5 in (114.3 mm)	
	Offset	1.81 in (46 mm)	

Refill capacities

PCD: Pitch Circle Diameter (installation holes)

NOTE

- Contact an authorized Mitsubishi Motors dealer for details on the combination used on your vehicle.

NOTE

- These tires satisfy vehicle loading conditions described in this owner's manual.

Refill capacities

N01148002101

Item			Capacity	Lubricants	
Fuel (approximate)	Front-wheel drive vehicles		15.5 gal (59.0 L)	Refer to "Fuel selection" on page 3-2.	
	All-wheel drive vehicles		14.5 gal (55.0 L)		
Engine oil	2.0 liter	Except for vehicles with turbocharger	Oil pan	4.2 qt (4.0 L)	Engine oils displaying the ILSAC certification mark ("starburst" symbol) on the container. If these oils are not available, an API classification SN or higher can be used.
			Oil filter	.32 qt (0.3 L)	
		Vehicles with turbocharger	Oil pan	5.1 qt (4.8 L)	
			Oil filter	.32 qt (0.3 L)	
	2.4 liter	Oil pan	4.5 qt (4.3 L)		
		Oil filter	.32 qt (0.3 L)		
Power steering			As required	Mitsubishi Motors Genuine Power Steering Fluid	
Manual transaxle			2.6 qt (2.5 L)	Mitsubishi Motors Genuine NEW MULTI GEAR OIL API classification GL-3 SAE 75W-80	
Continuously variable transmission (CVT)			7.5 qt (7.1 L)	Refer to "Continuously variable transmission (CVT) fluid" on page 9-11.	

11

Refill capacities

Item		Capacity	Lubricants
Twin Clutch SST		8.0 qt (7.6 L) {includes .53 qt (0.5 L) in oil cooler}	Refer to “Twin Clutch Sportronic shift transmission (Twin Clutch SST) fluid” on page 9-12.
Transfer oil	Except for vehicles with ACD	.53 qt (0.5 L)	Mitsubishi Motors Genuine Super Hypoid Gear Oil API classification GL-5 SAE 80
	Vehicles with ACD	.85 qt (0.8 L)	Mitsubishi Motors Genuine LSD gear oil
AWC control fluid		.95 qt (0.9 L) {Includes hydraulic piping}	DIAMOND ATF SP III
Rear differential oil	Except for vehicles with ACD	.42 qt (0.4 L)	Mitsubishi Motors Genuine Super Hypoid Gear Oil API classification GL-5 SAE 80
	Vehicles with ACD	.58 qt (0.55 L)	Mitsubishi Motors Genuine LSD gear oil
Brake/Clutch (if so equipped)		As required	Conforming to Brake fluid DOT3 or DOT4
Hood lock release mechanism and safety catch		As required	Multipurpose type grease NLGI Grade 2
Engine coolant {Includes .63 qt (0.65 L) in reserve tank}	Manual trans-axle	7.4 qt (7.0 L)	Mitsubishi Motors Genuine Super Long Life Coolant Premium or an equivalent*
	CVT	7.4 qt (7.0 L)	
	Twin Clutch SST	7.9 qt (7.5 L)	
Washer fluid		4.3 qt (4.0 L)	—
Refrigerant (air conditioning)		Refer to the “Air conditioning label” on page 11-2.	HFC-134a

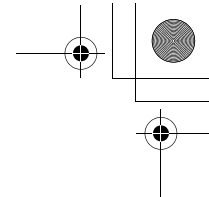
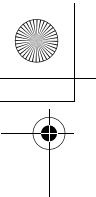

Refill capacities

*: similar high quality ethylene glycol based non-silicate, non-amine, non-nitrate and non-borate coolant with long life hybrid organic acid technology

ACD: Active center differential system

LSD: Limited slip differential

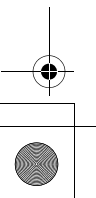
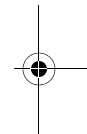
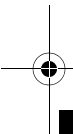

11-8 Specifications

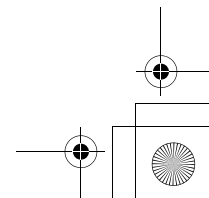
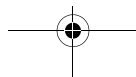

Alphabetical index

A

Accessory (installation) 3-6
 ACD (Active center differential system) 5-82
 ACD control mode display 5-83
 ACD control mode switch 5-82
 ACD warning display 5-83
 Active stability control (ASC) 5-94
 ASC OFF display or ASC indicator .. 5-95
 ASC operation display 5-95
 Air cleaner filter 9-9
 Air conditioning
 Automatic air conditioning 7-17, 7-22
 Important air conditioning operating tips.. 7-28
 Manual air conditioning 7-7, 7-12
 Air purifier 7-28
 All-wheel driving operation 5-86
 Aluminum wheels 9-52
 AM/FM radio 7-29
 Antenna
 Roof antenna 7-63
 Anti-lock braking system 5-91
 Warning light / display 5-92
 Arm rest 4-6
 Assist grip 5-191
 Audio
 AM/FM radio 7-29
 CD player 7-29

Troubleshooting 7-61
 Automatic air conditioning 7-17, 7-22
 AWC control fluid 9-12

B

Back-up lights
 Bulb capacity 9-34
 Replacement 9-45
 Ball joint, steering linkage seals and drive shaft boots 9-27
 Battery 9-14
 Charging system warning light 5-145
 Checking battery electrolyte level 9-15
 Disconnection and connection 9-16
 During cold weather 9-16
 Removing and installing the battery upper cover (vehicles with turbocharger). 9-14
 Specification 11-5
 Bluetooth 2.0 interface 5-159
 Bottle holder 5-191
 Brake
 Anti-lock braking system 5-91
 Braking 6-5
 Fluid 9-13, 11-6
 Hose 9-27
 Parking brake 5-48
 Parking brake lever stroke 9-25
 Pedal 5-89
 Pedal free play 9-25
 Power brakes 5-89

Service brake 5-89
 Brake assist 5-90
 Break-in recommendations 5-3
 Bulb capacity 9-34

C

California Perchlorate Materials
 Requirements 3-7
 Capacities 11-6
 Card holder 5-184, 5-188
 Cargo loads 6-10
 Catalytic converter 9-2
 CD player 7-29
 Certification label 11-3
 Charging system warning light 5-145
 Chassis number 11-2
 Child restraint 4-14
 Child safety locks for rear door 5-39
 Cleaning
 Inside of your vehicle 9-48
 Outside of your vehicle 9-49
 Clock 7-64
 Clutch
 Fluid 9-13, 11-6
 Pedal free play 9-24
 Coat hooks 5-192

Alphabetical index

Combination headlights and dimmer switch .. 5-147	Coming home light 5-151
Consumer information 10-2	Continuously variable transmission (CVT).... 5-61
Fluid 9-11, 11-6	Selector lever operation..... 5-61
Sports mode 5-66	Coolant (engine)..... 9-8, 11-6
Cruise control..... 5-97	Indicator 5-98
Cup holder 5-190	

D

Daytime running lights	Bulb capacity 9-34
Replacement 9-38	Defogger (rear window) 5-158
Defrosting or defogging (windshield, door windows)..... 7-12, 7-17, 7-22, 7-27	Digital clock
Time setting 7-59	Dimensions 11-4
Dimmer (high/low beam change) 5-150	Disc brake pads 9-27
Dome light	Bulb capacity 9-36

12-2

Replacement..... 9-47	Switch..... 5-186
Dome light/Reading lights	Bulb capacity 9-36
Replacement..... 9-46	Switch..... 5-186
Doors	Lock 5-35
Power door locks 5-37	Drive mode indicator 5-85
Drive mode-selector 5-84	Driving during cold weather..... 6-4
Driving, alcohol and drugs 6-2	

E

Electric rear window defogger switch.. 5-158	Electronic immobilizer (Anti-theft starting system) 5-4, 5-28
Electronically controlled 4WD system .. 5-84	Drive mode indicator..... 5-85
Drive mode-selector 5-84	Emergency key 5-23
Emission-control system maintenance... 9-25	Engine
Compartment..... 9-5	Coolant 9-8, 11-6
Hood..... 9-3	Oil and oil filter 9-6, 11-6
Overheating..... 8-4	

Serial number 11-2	Specifications..... 11-5
Engine coolant temperature display 5-117	Exhaust system..... 9-27

F

Filling the fuel tank..... 3-4	Floor console box 5-189
Floor mat 6-2	Fluid..... 11-6
AWC control fluid 9-12	Brake fluid..... 9-13, 11-6
Clutch fluid..... 9-13, 11-6	Continuously variable transmission (CVT) fluid 9-11, 11-6
Engine coolant 9-8, 11-6	Power steering fluid 9-14, 11-6
Twin Clutch Sportronic shift transmission (Twin Clutch SST) fluid..... 9-12, 11-6	Washer fluid 11-6
Fluid capacities and lubricants 11-6	Fog lights
Bulb capacity 9-34	Indicator 5-143
Replacement 9-41, 9-42	Switch 5-153
Free-hand advanced security transmitter (F.A.S.T.-key)..... 5-12	Front console boxes 5-189

Alphabetical index

Front console tray 5-189
 Front seats..... 4-3
 Front turn signal lights
 Replacement 9-40
 Front turn signal, parking and side-marker
 lights
 Bulb capacity 9-34
 Replacement 9-39, 9-40
 Fuel
 Fuel economy 6-2
 Fuel hoses 9-26
 Modification/alterations to the electrical or
 fuel systems 3-6
 Tank capacity 3-4, 11-6
 Fuel Pump Shut-off System 8-15
 Fuel selection 3-2
 Fuses 9-29
 Fusible links 9-28

G

General maintenance 9-27
 General vehicle data 11-4
 Genuine parts 3-6
 Glove compartment..... 5-188

H

Hazard warning flasher switch 5-153

Hazard warning lights 5-143
 Head restraints 4-6
 Headlight leveling switch 5-152
 Headlights
 Bulb capacity 9-34
 Dimmer 5-150
 Headlight flasher 5-150
 Leveling switch 5-152
 Replacement 9-36
 Switch 5-147
 Heater without air conditioning function. 7-4
 High beam indicator 5-143
 Hill start assist (vehicles with Twin Clutch
 SST) 5-90
 Hood lock release mechanism and safety
 catch 9-28
 Horn switch 5-159

I

If the vehicle breaks down..... 8-2
 Ignition switch 5-16, 5-53
 Important facts to know in case of an accident
 10-4
 Indicators 5-143
 Information screen display 5-145
 Inside day/night rearview mirror 5-50
 Inside emergency trunk lid release 5-41

Interior lights 5-185

J

Jack 8-5
 Storage 8-5
 Jump-starting the engine 8-2

K

Key reminder buzzer 5-36
 Keyless entry system 5-7
 Keys 5-3

L

Labeling 11-2
 License plate light
 Bulb capacity 9-34
 Replacement 9-45
 Limited-slip differential 5-88
 Link System 5-159
 Loading information 6-6
 Lubricants 11-6
 Luggage floor boxes 5-190

M

Malfunction indicator 5-144
 Manual air conditioning 7-12

Alphabetical index

Manual transaxle 5-59
 Oil 9-11, 11-6
 Shift points (recommended speed).... 5-60
 Mirror
 Inside day/night rearview mirror 5-50
 Outside rearview mirrors 5-52
 Modifications to and racing of your vehicle...
 3-5
 Multi-information display 5-110

O

Octane requirement..... 3-2
 Oil
 Engine oil 9-6, 11-6
 Manual transaxle oil 9-11, 11-6
 Rear axle oil..... 9-12
 Transfer oil 9-12
 Operation under adverse driving conditions...
 8-14
 Outside rearview mirrors 5-52
 Overheating 8-4

P

Parking 6-6
 Parking brake 5-48
 Parking brake lever stroke 9-25
 Polishing 9-51
 Power brakes..... 5-89

12-4

Power door locks..... 5-37
 Power steering
 Fluid 9-14, 11-6
 System 5-96
 Power windows..... 5-44
 Puncture (Tire changing)..... 8-6

R

Radiator cap 9-9
 Radio
 General information about your radio 7-65
 Rain sensor 5-155
 Rear axle oil 9-12
 Rear side-marker lights
 Bulb capacity 9-34
 Replacement 9-44
 Rear turn signal lights
 Bulb capacity 9-34
 Replacement 9-44
 Rear window defogger switch 5-158
 Rear-view camera 5-106
 Rearview mirror
 Inside 5-50
 Outside 5-52
 Refrigerant (air conditioning) 11-6
 Replacement of light bulbs 9-34
 Replacing tires and wheels 9-22

Reporting Safety Defects 10-2
 Roof antenna 7-63

S

Safe driving techniques 6-4
 Seat 4-2
 Arm rest 4-6
 Front seats 4-3
 Heated seats 4-5
 Rear seats 4-5
 Seats and restraint systems 4-2
 Seat belt 4-8
 Adjustable seat belt shoulder anchor. 4-12
 Child restraint 4-14
 Driver's seat belt reminder/warning.. 4-11
 Force limiter 4-14
 Front passenger seat belt warning light
 4-12
 Maintenance and inspection 4-21
 Pre-tensioner 4-13
 Seat belt extender 4-12
 Seat belt instructions 4-9
 Seat belt use during pregnancy 4-13
 Service brake..... 5-89
 Service precautions 9-2
 Snow tires 9-24
 Spark plugs 9-26
 Steering
 Power steering fluid 9-14, 11-6

Tilt lock lever	5-50	Tissue holder	5-190
Wheel lock	5-20, 5-55	Tools	8-5
Storage spaces	5-187	Storage	8-5
Sun visors	5-184	Towing	8-12
Supplemental Restraint System	4-21	Trailer towing	6-11
How the Supplement Restraint System works	4-24	Transfer oil	9-12
Servicing	4-36	Trunk area light	
Warning light/display	4-27	Replacement	9-48
<hr/> T <hr/>			
Tank capacity	3-4, 11-6	Trunk lid	5-39
Theft-alarm system		Turbocharger operation	5-59
System	5-42	Turn signal light	
Time Setting	7-59	Indicators	5-143
Tire pressure monitoring system	5-102	Turn signal lights	
Warning light/display	5-103	Bulb capacity	9-34
Tires	9-17	Lever	5-152
How to change a tire	8-6	Replacement	9-40
Inflation pressure	9-21	Twin Clutch SST (Sportronic Shift	
Maintenance	9-22	Transmission)	5-70
Quality grading	10-2	Fluid	9-12, 11-6
Replacing tires and wheels	9-22	Gearshift lever operation	5-70
Rotation	9-23	Gearshift lever position display	5-71
Size (tire and wheel)	11-5	Manual shift	5-76
Snow tires	9-24	Manual shift display	5-79
Tire and loading information placard . 6-7, 11-3		Twin Clutch SST control mode display ...	5-76
Tire chains	9-24	Twin Clutch SST control mode switch	5-75
Tread wear indicators	9-23	Warning display	5-72

Alphabetical index

U

USB input terminal	5-181
How to connect an iPod	5-182
USB input terminal device	
How to connect a USB memory	5-181

V

Vanity mirror	5-184
Vehicle care precautions	9-48
Vehicle dimensions	11-4
Vehicle labeling	11-2
Vehicle preparation before driving	6-3
Vehicle weights	11-4
Vents	7-2

W

Warning lights	5-144
Washer	
Fluid	9-13, 11-6
Switch	5-157
Windshield washer	5-157
Waxing	9-51
Weights	11-4
Welcome light	5-151
Wheel	
Covers	8-11



Alphabetical index

Specification	11-5
Wiper	
Rain sensor	5-155
Windshield	5-154
Wiper blades	9-25

