

## Table of contents

<b>Overview</b>	<b>1</b>
<b>Quick index</b>	<b>2</b>
<b>General information/Charging</b>	<b>3</b>
<b>Seat and restraint systems</b>	<b>4</b>
<b>Features and controls</b>	<b>5</b>
<b>Driving safety</b>	<b>6</b>
<b>Comfort controls</b>	<b>7</b>
<b>For emergencies</b>	<b>8</b>
<b>Vehicle care and maintenance</b>	<b>9</b>
<b>Customer assistance/Reporting Safety Defects</b>	<b>10</b>
<b>Specifications</b>	<b>11</b>
<b>Alphabetical index</b>	<b>12</b>

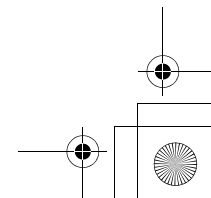
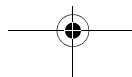
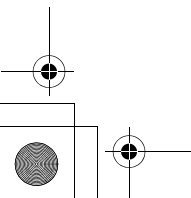
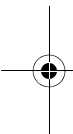

## Instruments and controls

# 1 Instruments and controls

N00100202980

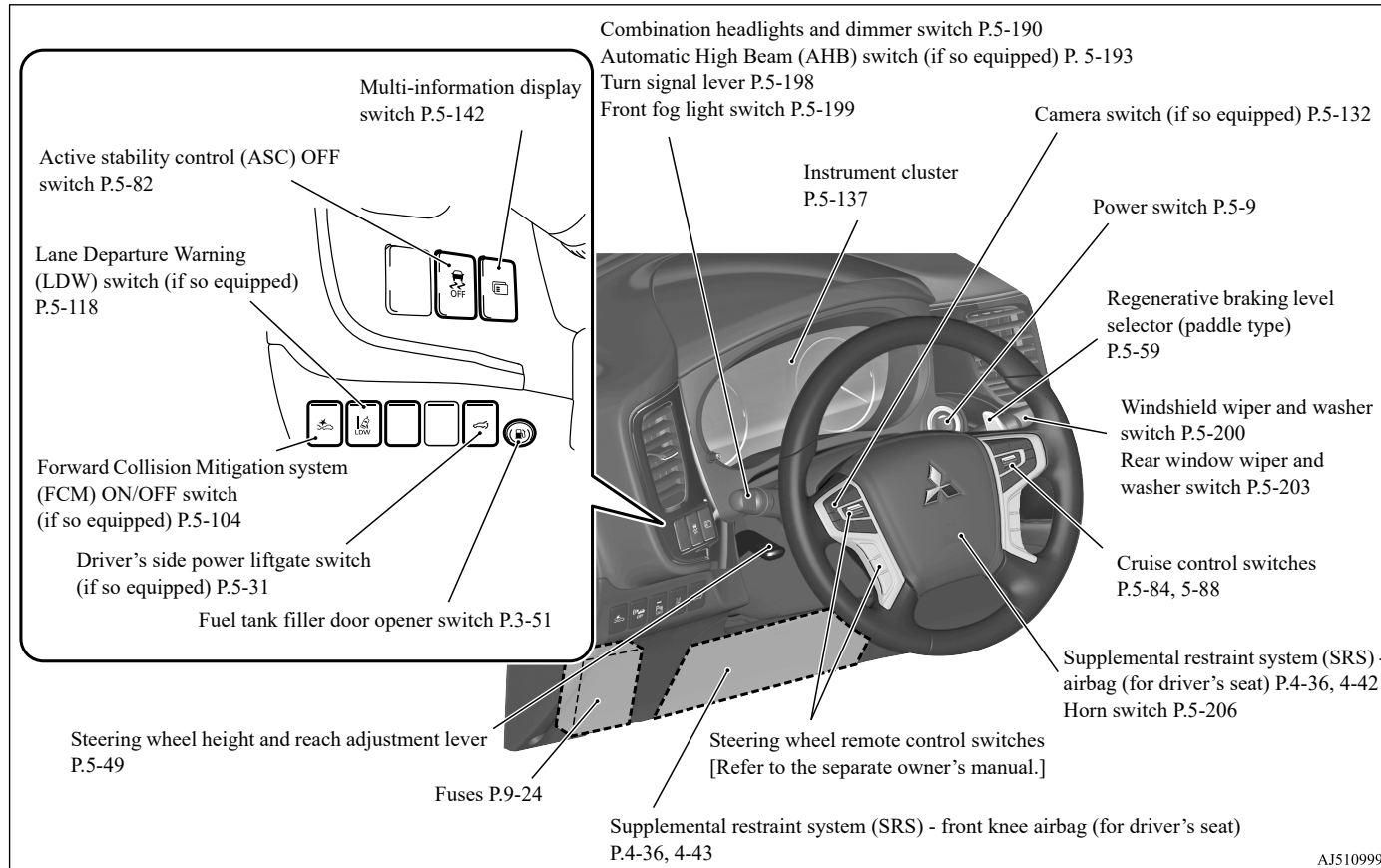

AJ5109990

### 1-1 Overview



## Instruments and controls

1

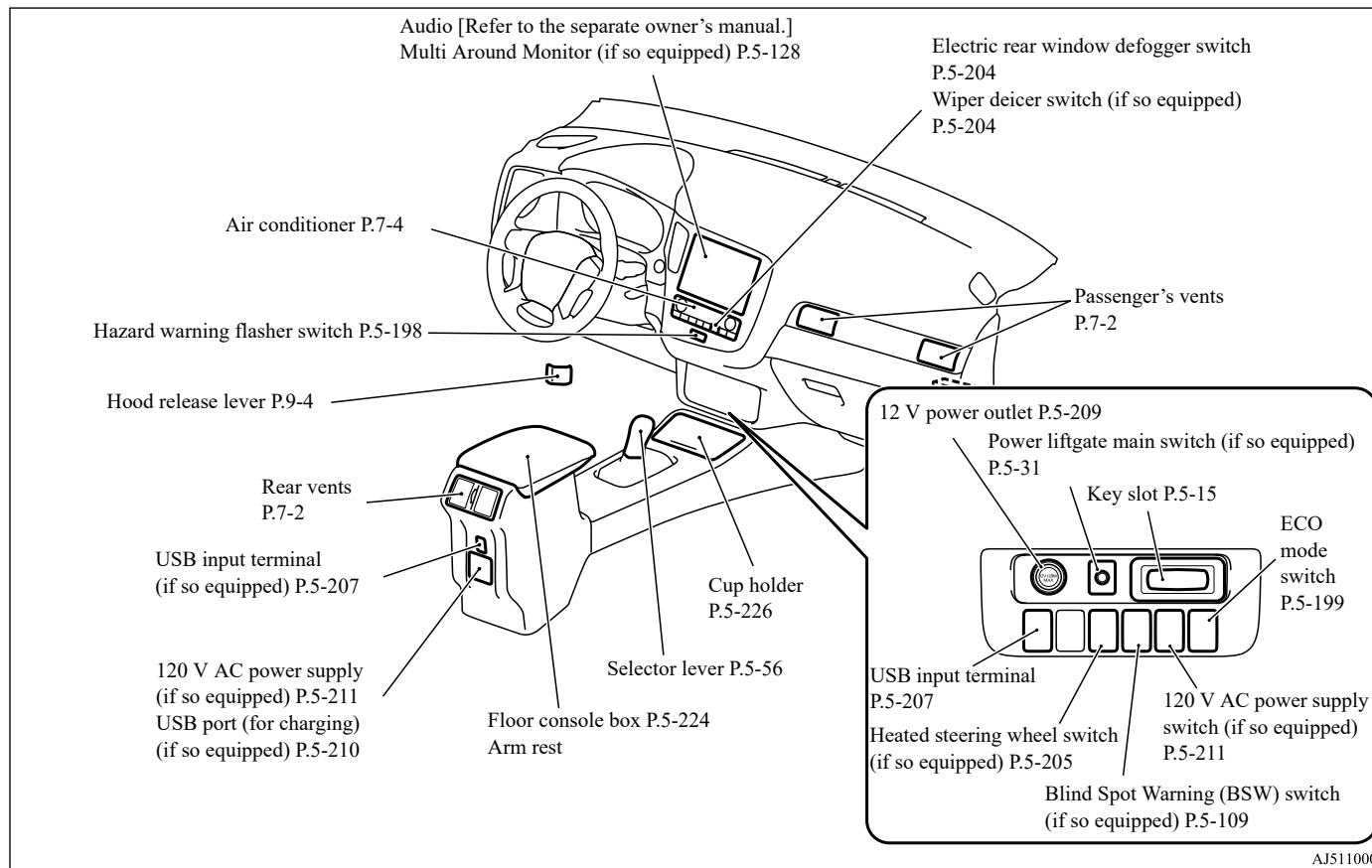

## Instruments and controls

1

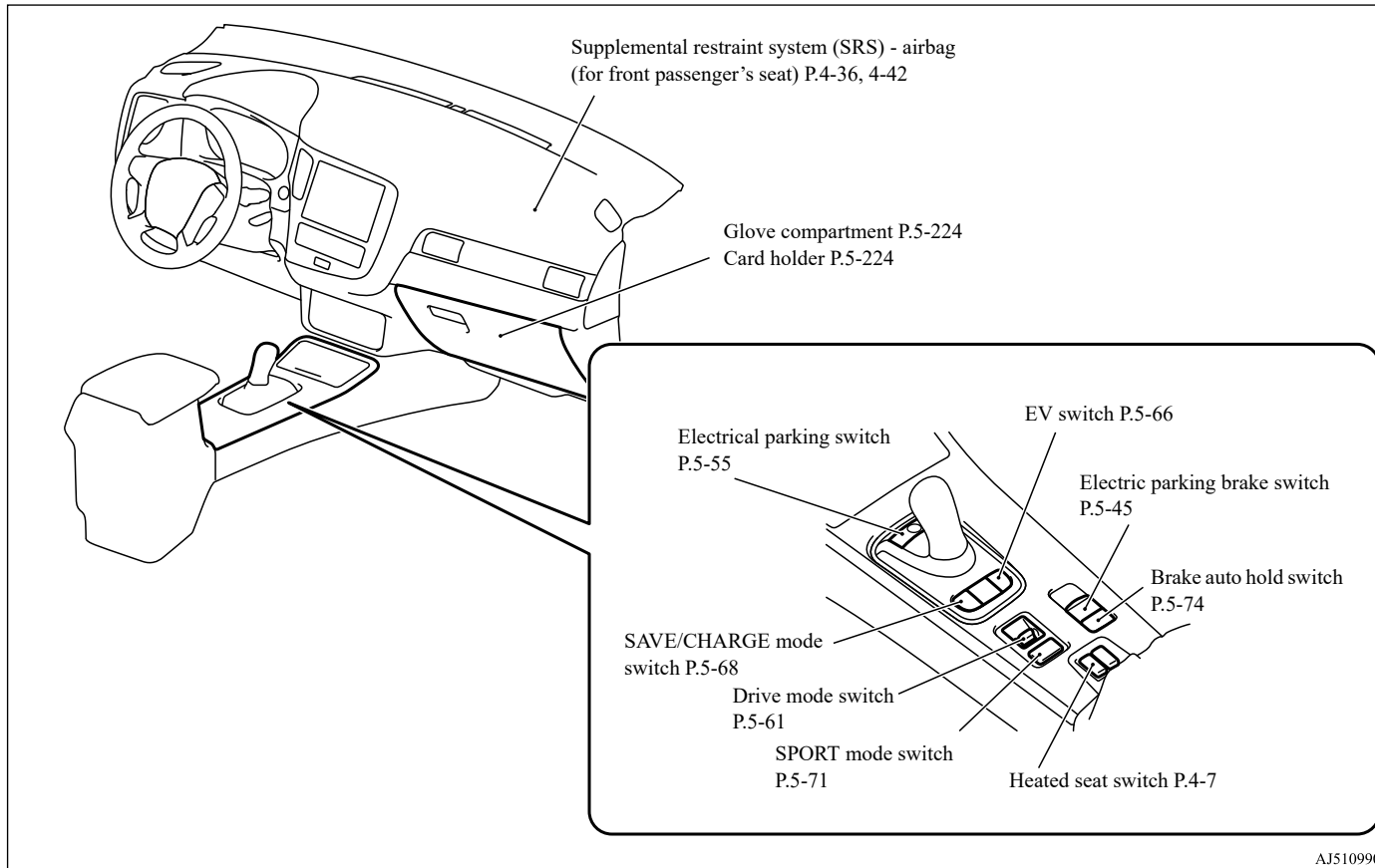

Interior

N00100302659

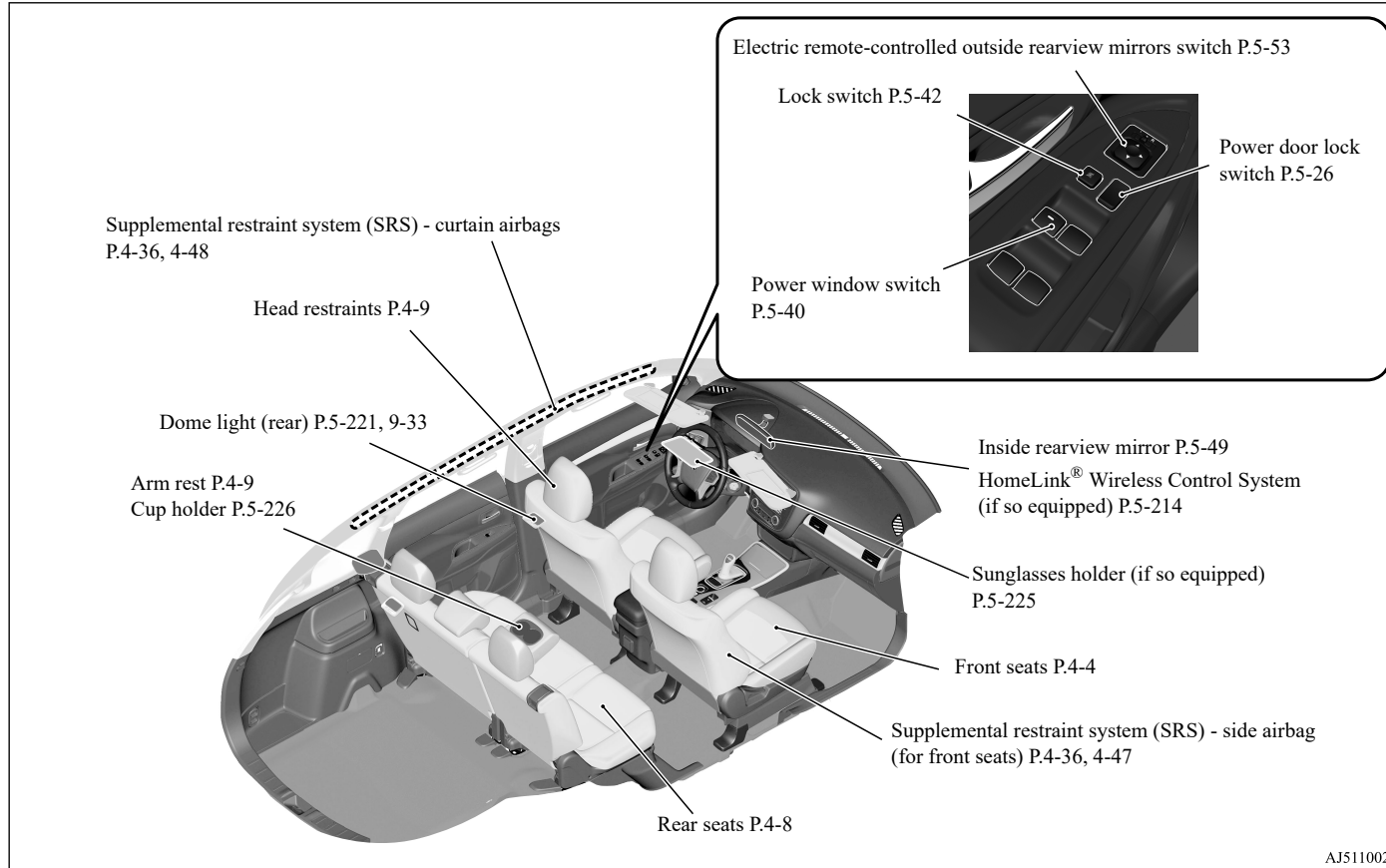

AJ5110020

## Interior

1

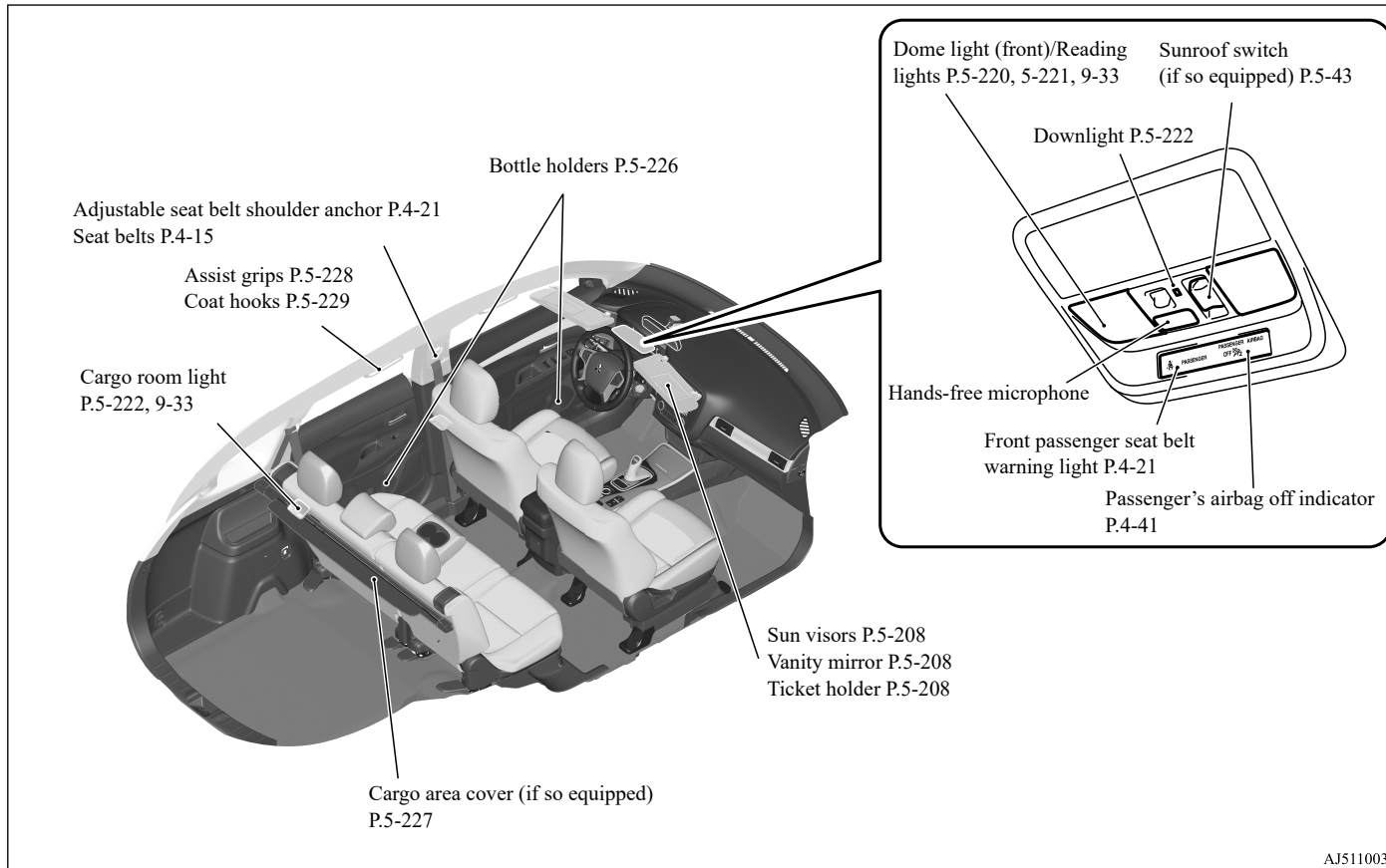

### 1-5 Overview

Luggage area

Luggage area

1

N00100501612

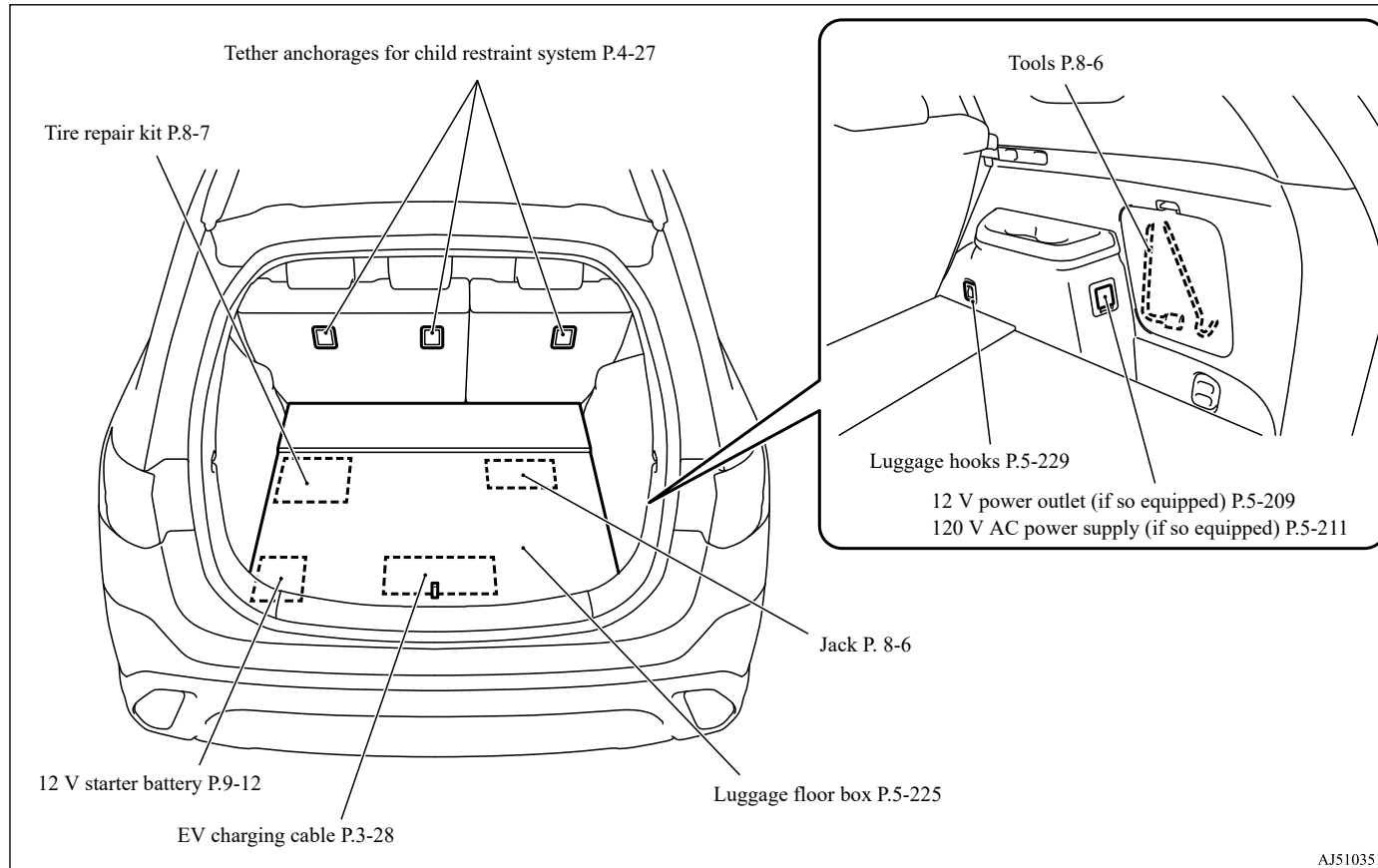

AJ5103510

Overview 1-6

### Outside (Front)

## 1 Outside (Front)

N0010060307

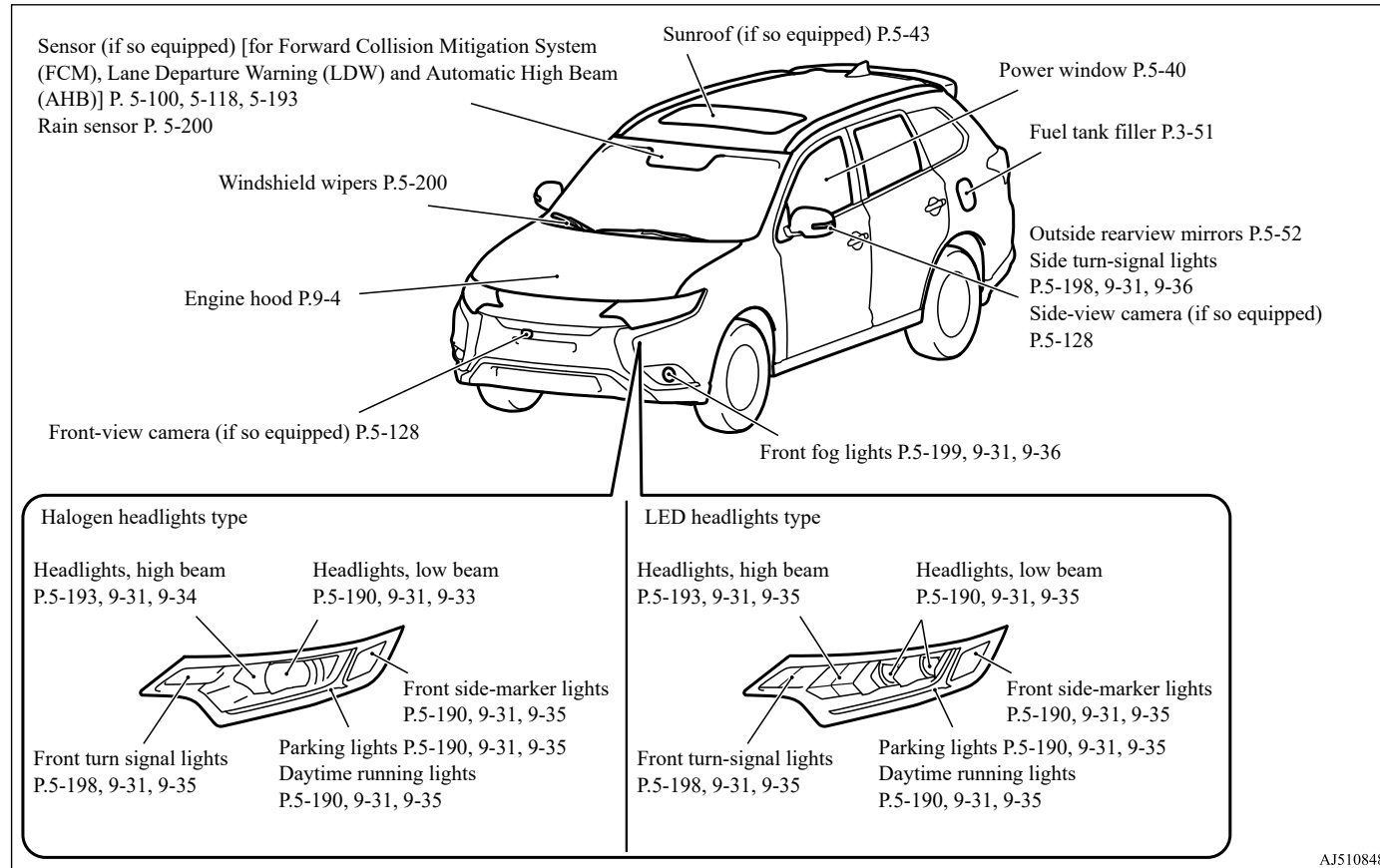

AJ5108485

Outside (Rear)

Outside (Rear)

1

N0010060297

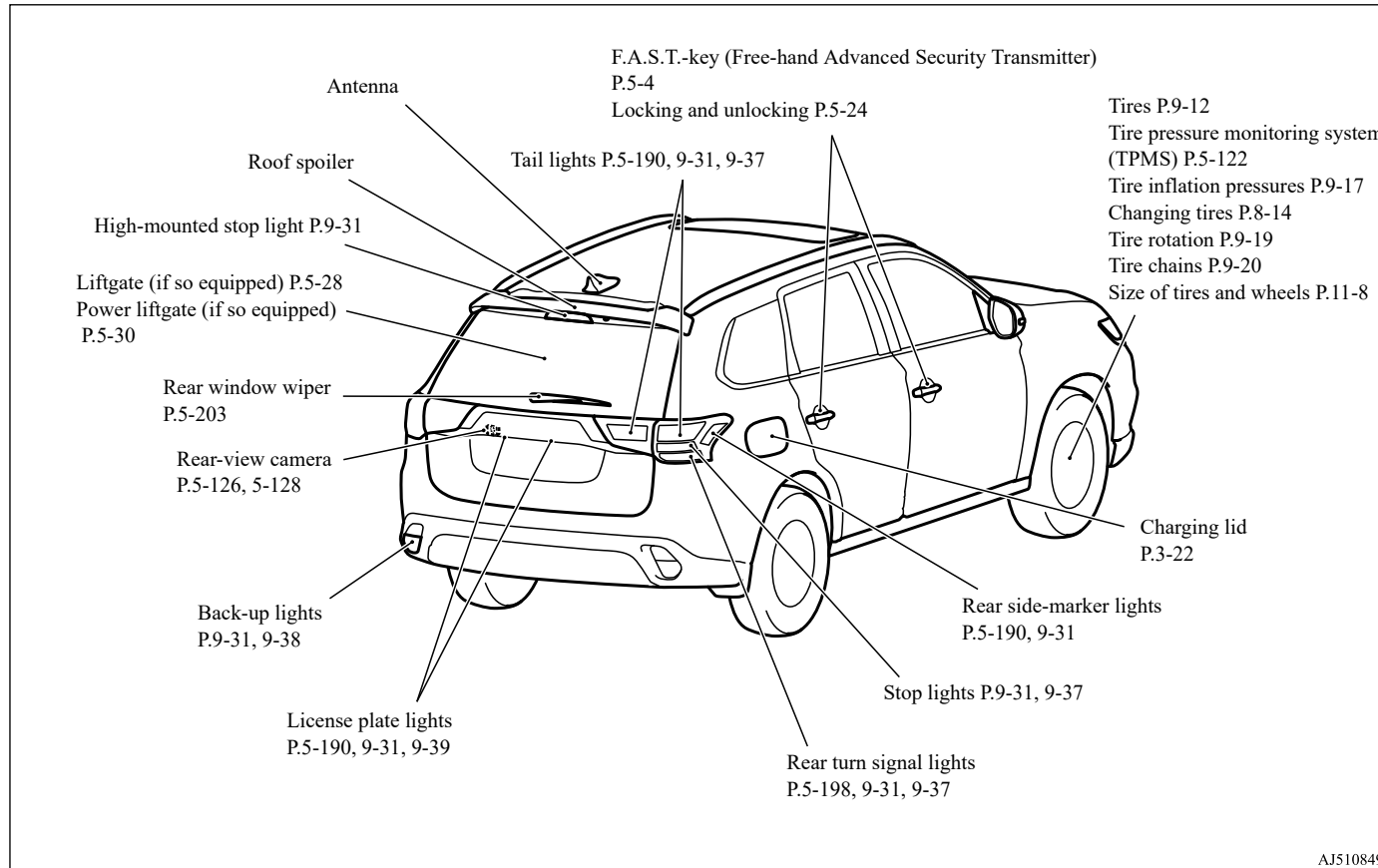

AJ5108498

Overview 1-8





If this warning light comes on or flashes while you're driving...



**If this warning light comes on or flashes while you're driving..**

N00200702407

**2**

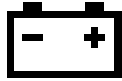

**NOTE**

- For information regarding warning displays in the multi-information display, refer to “Multi-information display” on page 5-140.
- These warning lights will come on for a few seconds for a bulb check when the operation mode of the power switch is put in ON.

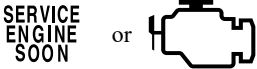

Warning lights	Do this	Ref. Page
 12 V starter battery charging system warning light	<ul style="list-style-type: none"> <li>● Park your vehicle in a safe place and stop the Plug-in Hybrid EV System. Contact a certified Mitsubishi EV dealer.</li> </ul>	P. 5-188
<b>BRAKE</b> or  Brake warning light	<ul style="list-style-type: none"> <li>● If this light comes on while driving, check to see that the parking brake is released.</li> <li>● If this light stays on after releasing the Electric parking brake, immediately stop and check the brake fluid level.</li> <li>● If the brake fluid level is correct, there may be a system malfunction. Avoid hard braking and high speed and contact a certified Mitsubishi EV dealer.</li> </ul>	P. 5-187
 Electric parking brake warning light	<ul style="list-style-type: none"> <li>● When the warning light remains on or does not come on, there is the possibility that the parking brake cannot be operated or released. Immediately contact the nearest certified Mitsubishi EV dealer.</li> <li>● If the warning light comes on during driving, immediately stop the vehicle in a safe place, and contact a certified Mitsubishi EV dealer.</li> </ul>	P. 5-188

If this warning light comes on or flashes while you're driving...

2

Warning lights	Do this	Ref. Page
 <p>Plug-in Hybrid EV System warning light</p>	<ul style="list-style-type: none"> <li>● If the warning light comes on, there may be a malfunction in the Plug-in Hybrid EV System.</li> <li>● If the “EV SYSTEM SERVICE REQUIRED” warning display may appear on the multi-information display, have your vehicle inspected by a certified Mitsubishi EV dealer.</li> <li>● If the “EV SYSTEM SERVICE REQUIRED STOP SAFELY” warning display may appear on the multi-information display, park your vehicle in a safe place and contact a certified Mitsubishi EV dealer.</li> </ul>	<p>P. 5-189</p>
 <p>Engine malfunction indicator (“SERVICE ENGINE SOON” or “Check engine light”)</p>	<ul style="list-style-type: none"> <li>● If the indicator comes on, there may be a malfunction in the emission or engine control system.</li> <li>● Although your vehicle will usually be drivable and not need towing, have the emission or engine control system checked at a certified Mitsubishi EV dealer as soon as possible. If the vehicle is not drivable, contact emergency roadside assistance at 1-888-648-7820 (for vehicles sold in U.S.A.) or 1-888-576-4878 (for vehicles sold in Canada), a certified Mitsubishi EV dealer, or local towing company for assistance.</li> </ul>	<p>P. 5-188</p>
 <p>Anti-lock braking system warning light</p>	<ul style="list-style-type: none"> <li>● When this light comes on, the anti-lock braking system is not functioning and only the ordinary braking system is functioning.</li> <li>● Park your vehicle in a safe place and stop the Plug-in Hybrid EV System. Test the system as described on page 5-79.</li> <li>● If the light does not go out after the test, or if it comes on again, we recommend that you have the system checked at a certified Mitsubishi EV dealer as soon as possible.</li> </ul>	<p>P. 5-79</p>
 <p>SRS warning light</p>	<ul style="list-style-type: none"> <li>● Immediately have the airbag and the pre-tensioner seat belt system checked at a certified Mitsubishi EV dealer.</li> </ul>	<p>P. 4-42</p>

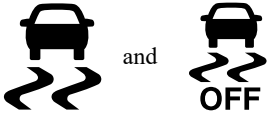
If this warning light comes on or flashes while you're driving...

Warning lights	Do this	Ref. Page
 <p>ASC indicator and ASC OFF indicator</p>	<ul style="list-style-type: none"> <li>● Park your vehicle in a safe place and stop the Plug-in Hybrid EV System. Restart the Plug-in Hybrid EV System and check whether the indicator goes out.</li> <li>● If the indicator does not go out, or if it comes on again, have your vehicle inspected by a certified Mitsubishi EV dealer as soon as possible.</li> <li>● When this indicator comes on, the active stability control is not functioning and normal operation of the vehicle will not be affected.</li> </ul>	<p>P. 5-84</p>
 <p>ASC indicator</p>	<ul style="list-style-type: none"> <li>● Park your vehicle in a safe place and stop the Plug-in Hybrid EV System. Restart the Plug-in Hybrid EV System and check whether the indicator goes out.</li> <li>● If the indicator does not go out, or if it comes on again, have your vehicle inspected by a certified Mitsubishi EV dealer as soon as possible.</li> <li>● When this indicator comes on, the hill start assist is not functioning. Start off carefully on a steep uphill slope.</li> </ul>	<p>P. 5-77</p>
<p><b>RBS</b></p> <p>Regenerative brake warning light</p>	<ul style="list-style-type: none"> <li>● If the warning light comes on, there may be a malfunction in the regenerative brake system. Have the vehicle inspected at a certified Mitsubishi EV dealer.</li> </ul>	<p>P. 5-189</p>
 <p>Tire pressure monitoring system warning light</p>	<ul style="list-style-type: none"> <li>● If the warning light comes on, you should stop and adjust the tires to the proper inflation pressure as soon as possible. (See "Tire inflation pressures" on page 9-17.) Once adjustments have been made, the warning light will go off after a few minutes of driving.</li> <li>● If the warning light blinks for approximately 1 minute and then remains continuously illuminated, the system is not operating properly. If the system returns to normal, the warning light will go off. If the warning light does not go off, have the vehicle inspected at a certified Mitsubishi EV dealer.</li> </ul>	<p>P. 5-122</p>

If this problem occurs...

2

Warning lights	Do this	Ref. Page
 <p>LED headlight warning light (Vehicles equipped with LED headlight)</p>	<ul style="list-style-type: none"> <li>If the warning light comes on, there may be a malfunction in the LED headlight unit. Have the vehicle inspected at a certified Mitsubishi EV dealer.</li> </ul>	<p>P. 5-192</p>

If this problem occurs...

N00200902180

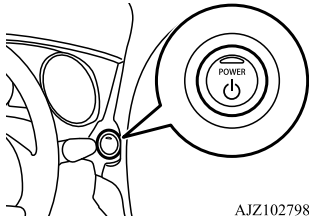
Problem	Do this	Ref. Page
<p>The Plug-in Hybrid EV System does not start when the power switch is pressed.</p>  <p>AJZ102798</p>	<p>Make sure the F.A.S.T.-key is in the vehicle. Make sure the select position is in the “P” (PARK) position, and then press the power switch while depressing the brake pedal.</p>	<p>P. 5-14</p>
<p>The Plug-in Hybrid EV system does not start and the operation mode cannot be changed to OFF.</p>	<ol style="list-style-type: none"> <li>Put the select position in “P” (PARK) position, and then change the operation mode to OFF.</li> <li>One of the other causes could be low 12 V starter battery voltage. If this occurs, the keyless entry system and the F.A.S.T.-key operation will also not operate. Contact a certified Mitsubishi EV.</li> </ol>	<p>P. 5-11</p>

If this problem occurs...

Problem	Do this	Ref. Page
The F.A.S.T.-key does not operate.	Insert the F.A.S.T.-key into the key slot of the instrument panel, and then start the Plug-in Hybrid EV System or change the operation mode. Use the emergency key to lock and unlock the driver's door.	P. 5-15
Cannot shift the select position from the "P" (PARK) position.	Make sure the ready indicator illuminates, and move the selector lever while pressing the brake pedal. If the ready indicator does not illuminate, you can shift the select position to the "N" (NEUTRAL) position only.	P. 5-57
The windows are fogged up. 	Press the defogger switch to change to the "☁" position.	P. 7-9
The Plug-in Hybrid EV system does not start. The lights do not come on. The lights are dim. The horn does not honk. The horn sound is weak.	Have the 12 V Starter battery checked. Recharge or replace the 12 V Starter battery at a certified Mitsubishi EV dealer.	P. 8-2, 9-12

**2**

Quick index 2-5

If this problem occurs...

**2**

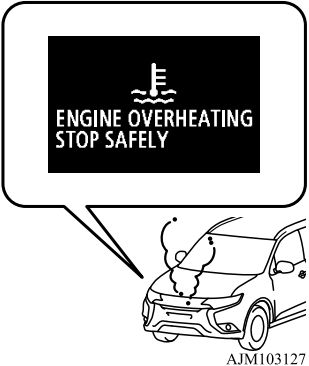
Problem	Do this	Ref. Page
<p>The information screen in the multi-information display will be interrupted and the engine coolant temperature warning display will appear.</p>  <p>AJM103127</p> <p>Steam comes out of the engine compartment.</p>	<p>The engine is overheated. Carefully stop the vehicle in a safe place.</p>	<p>P. 8-4</p>

If this problem occurs...

Problem	Do this	Ref. Page
If your vehicle becomes stuck in sand, mud or snow	<ol style="list-style-type: none"> <li>1. Operate the drive mode switch to set the "LOCK" mode, temporarily turning off Active stability control (ASC) with the ASC OFF switch and slowly press down on the accelerator pedal to get your vehicle moving again.</li> <li>2. If there is nothing to stop your tires from slipping, rock your vehicle out of the stuck position.</li> </ol>	P. 8-19

**2**

**⚠ WARNING**

- When attempting to rock your vehicle out of a stuck position, be sure that no one is near the vehicle. The rocking motion may cause the vehicle to suddenly lurch forward or backward, possibly injuring bystanders.
- Avoid spinning the wheels. Prolonged efforts to free a stuck vehicle may result in overheating and transaxle failure.

**If the vehicle remains stuck after several rocking attempts, have a towing service pull the vehicle out.**

Problem	Do this	Ref. Page
The brakes are not functioning properly after driving through water.	Dry out the brakes by driving slowly while lightly pressing the brake pedal.	P. 6-5
A tire is punctured. 	<ol style="list-style-type: none"> <li>1. Park the vehicle in a safe place where the surface is flat and level.</li> <li>2. Repair the flat tire with tire repair kit.</li> </ol>	P. 8-7

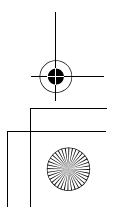
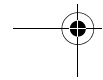
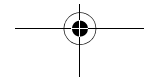
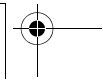
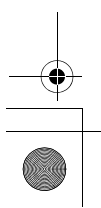
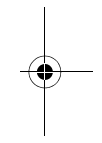
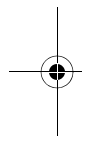
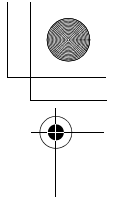
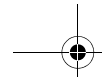
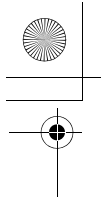

Handwriting practice area consisting of ten horizontal dashed lines.



## General information/Charging

### 3

Plug-in Hybrid EV System .....	3-2	Event Data Recording .....	3-56
Main drive lithium-ion battery .....	3-6		
EV cruising range .....	3-7		
Operating sound under charging or Remote Climate Control .....	3-10		
For persons with electro-medical apparatus such as implantable cardiac pacemaker or implantable cardiovascular defibrillator .....	3-10		
Cautions and actions to deal with intense heat .....	3-12		
Cautions and actions to deal with intense cold .....	3-13		
Charging .....	3-17		
Precautions during Charging the Main Drive Lithium-ion Battery .....	3-19		
Normal charging (charging method with rated AC 120 V outlet) .....	3-20		
EV charging cable .....	3-28		
Normal charging (using 240 V Electric Vehicle Supply Equipment) .....	3-31		
Quick charging (charging method with quick charger) (if so equipped).....	3-32		
High-Voltage components .....	3-36		
MITSUBISHI Remote Control (if so equipped) .....	3-38		
How to use electric device during charging .....	3-42		
Charging troubleshooting guide .....	3-46		
Fuel selection .....	3-49		
Filling the fuel tank .....	3-51		
Modifications to and racing of your vehicle .....	3-54		
Genuine Mitsubishi Motors parts .....	3-56		
California Perchlorate Materials Requirements .....	3-56		



## Plug-in Hybrid EV System

### Plug-in Hybrid EV System

N01206500022

### 3 Main features

N01206600052

The Plug-in Hybrid EV system on this vehicle will automatically select an optimum driving mode from “EV drive mode”, “Series hybrid mode” and “Parallel hybrid mode” according to the remaining power in the main drive lithium-ion battery and/or driving conditions.

The vehicle is designed to typically use the EV drive mode which drives the vehicle as an electric vehicle by using only electrical power stored in the main drive lithium-ion battery.

However, when driving with the Series hybrid mode or the Parallel hybrid mode is required, the EV drive mode will automatically be switched to the Series hybrid mode or the Parallel hybrid mode.

The main drive lithium-ion battery can be charged using an EV charging device compatible with your vehicle. For details, refer to “Charging” on page 3-17.

The regenerative braking described in this section will also charge the main drive lithium-ion battery when the accelerator pedal is released while the vehicle is moving.

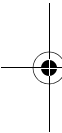

#### 3-2 General information/Charging



### EV drive mode

- The vehicle is driven only by electric motors using the electric power stored in the main drive lithium-ion battery.
- The EV drive mode will automatically be switched to the Series hybrid mode or the Parallel hybrid mode depending on the remaining power in the main drive lithium-ion battery and/or driving conditions, such as vehicle speed and operation of the air conditioner.

If you want to drive the vehicle without starting the engine as much as possible, make the switch to the EV priority mode by pressing the EV switch.

Refer to “EV switch” on page 5-66.

- The distance you can drive the vehicle (cruising range) using the EV drive mode varies depending on the remaining power in the main drive lithium-ion battery and/or driving conditions, such as vehicle speed and operation of the air conditioner.
- An estimated cruising range using the EV drive mode can be shown in the information screen. Refer to “EV cruising range display/Total cruising range display” on page 5-151.
- Driving at a moderate speed and avoiding rapid acceleration will help obtain longer cruising range using the EV drive mode.

Rapid and repeated accelerations and decelerations consumes more electric power from the main drive lithium-ion battery and may reduce the cruising range using the EV drive mode.

- The electric power in the main drive lithium-ion battery can be reserved in order to later drive the vehicle using the EV drive mode in a specific area. Refer to “SAVE/CHARGE mode switch” on page 5-68.

### Series hybrid mode

- The vehicle is driven by the motors only using the electricity generated by the engine. This mode is used when the remaining power in the main drive lithium-ion battery becomes low, when quick acceleration is required, or when more propulsion power is required like climbing a hill.

#### NOTE

- While driving the Series hybrid mode, the engine malfunction diagnostic system may operate. If this system operates, the engine sound will decrease. This does not indicate a malfunction.

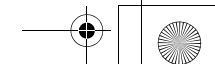
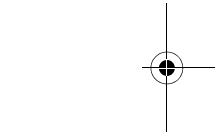
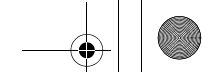

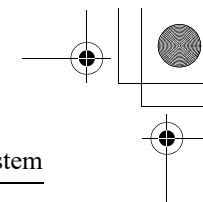
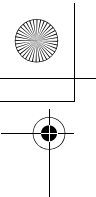

### Parallel hybrid mode

- The vehicle is driven mainly by the engine with assistance from the motors. This mode is used when the vehicle is driven at a high-speed.

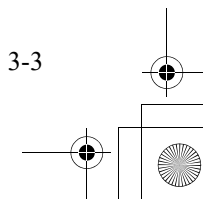
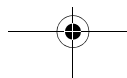
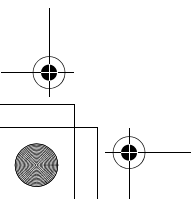
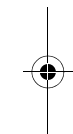
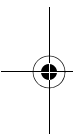



## Plug-in Hybrid EV System

### The roles of the motors and engine in each drive mode

**3**

	Motor	Engine
EV Drive Mode	Drives the vehicle	OFF
Series Hybrid Mode	Drives the vehicle	Generates electricity
Parallel Hybrid Mode	Drives the vehicle	Drives front wheels and generates electricity

### Regenerative braking

N01206700040

Motion energy is converted into electric energy using the motor as a power generator.

While decelerating, electric energy will be created and used to charge the main drive lithium-ion battery.

- If you lift your foot off the accelerator pedal while driving, a braking force equivalent to the engine braking of a gasoline or diesel powered vehicle will be generated.  
Also, if you shift the select position into “B” (REGENERATIVE BRAKE) from “D” (DRIVE), the regenerative brake force will become stronger. Shift the selector lever into “B” (REGENERATIVE BRAKE) position according to the driving condition.
- As greater brake force is applied by depressing the brake pedal, increased regenerative braking occurs.
- When stronger regenerative braking is generated, the stop lights will illuminate even when the brake pedal is not depressed.

#### NOTE

- When the main drive lithium-ion battery level is full or nearly full, or the main drive lithium-ion battery temperature is too high or too low, the regenerative braking force may temporarily be reduced or eliminated and stronger service brake effort may be required to operate the brakes. When the main drive lithium-ion battery level is no longer full or near full, or the main drive lithium-ion battery temperature has returned to a normal range, the regenerative brake force will resume.
- If a problem occurs in the Plug-in hybrid EV system, or if the ABS and/or the ASC have been activated, the regenerative braking will be restricted. The service brake will still operate.

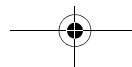

## Operation of gasoline engine

N01206800038

- When the vehicle is driven in the EV drive mode, the drive mode may automatically be switched to the Series hybrid mode or the Parallel hybrid mode under the following conditions:
  - If the temperature of the Plug-in hybrid EV system is too hot or too cold.
  - When quick acceleration is applied.
  - When the air conditioner is operating.
  - When the accelerator pedal is depressed hard on an uphill road or expressway.
  - In cold weather.
  - If the vehicle has not been refueled for a long period of time.
  - When the main drive lithium-ion battery level is low.

In addition to the above, there are other situations where the EV drive mode may automatically be changed to the series or parallel hybrid mode.

- While the vehicle is stationary, the engine may automatically start. Some examples are;
  - When the main drive lithium-ion battery level is low.
  - If the temperature of the Plug-in hybrid EV system is too hot or too cold.
  - When the air conditioner is operating.
  - If the vehicle has not been used for a long period of time.
  - If the engine has not been started for a long period of time.
  - If the vehicle has not been refueled for a long period of time.

## NOTE

- Depending on usage of the vehicle, the engine may not start for a long period of time and unused fuel will remain in the fuel tank. Fuel can deteriorate over time, which can adversely affect the engine and/or the fuel system.
 

If the vehicle is not refueled with more than 4 gallons (15 liters) at least once every three months, the engine will automatically start, while the ready indicator is illuminated, to help prevent deterioration of the fuel. At that time, charging of the main drive lithium-ion battery will start and the battery charge mode display will appear on the information screen in the multi-information display. The charging will stop, however, before the main drive lithium-ion battery is fully charged. The engine may also start even while the EV drive mode is selected or the vehicle is stationary.

To stop the engine from starting automatically when the vehicle is operated on the main drive lithium-ion battery power only for a long time, start the engine and drive the vehicle enough to reduce the fuel level to approximately half tank. Refill the fuel tank with at least 4 gallons (15 liters) of gasoline.

## Main drive lithium-ion battery

### Refueling (gasoline)

N01206900042

3

#### **CAUTION**

- If the fuel remaining warning display appears in the multi-information display, refuel the vehicle immediately. If the vehicle runs out of fuel, electricity cannot be generated by the engine and the following will occur.
  - The propulsion power of the vehicle may be reduced, since the vehicle must be driven using only electrical power stored in the main drive lithium-ion battery.
  - The heater for the air conditioner and the front window defogger will be degraded.
  - The catalytic converter may be damaged due to excessive high temperature.
 Refer to “Filling the fuel tank” on page 3-51 and “Fuel remaining display screen” on page 5-147.
- Depending on the usage of the vehicle, the engine may not start for a long period of time. Unused fuel can deteriorate over time. To avoid this situation, start the engine more than once every three months by activating the battery charge mode, or refill the vehicle with more than 4 gallons (15 liters) more than once every three months after the fuel remaining display is indicated below half. Refer to “SAVE/CHARGE mode switch” on page 5-68 and “Fuel remaining display screen” on page 5-147.

### Main drive lithium-ion battery

N01207000037

#### **WARNING**

- **The main drive lithium-ion battery is a sealed high voltage battery and has no user serviceable parts.**
  - **To avoid severe burns and/or electrical shock that may result in serious injury or death, never attempt to detach the main drive lithium-ion battery from the vehicle or try to disassemble it.**
  - **Never attempt to dispose or recycle the main drive lithium-ion battery by yourself. Consult with a certified Mitsubishi EV dealer, when the main drive lithium-ion battery is disposed or recycled.**
  - **Never attempt to use the main drive lithium-ion battery for any other purpose.**

#### **CAUTION**

- To help prevent damage to the main drive lithium-ion battery, follow the instructions described below. Failure to do so can result in damage to the main drive lithium-ion battery that will not be covered by the main drive lithium-ion battery warranty.

#### **CAUTION**

- Repeatedly performing quick charging can reduce battery capacity. Normal charging is recommended unless quick charging is necessary. For details of charging, refer to “Charging” on page 3-17.
- If your vehicle is not used for a long time, check the main drive lithium-ion battery level display every 3 months. If the gauge of the main drive lithium-ion battery level display screen in the multi-information display indicates that the battery level is completely empty, charge the main drive lithium-ion battery until an indication appears in the gauge. Refer to “Multi-information display” on page 5-140. Alternatively, start the Plug-in Hybrid EV System and turn on the ready indicator. The engine will then automatically start to charge the main drive lithium-ion battery. Wait until the engine automatically stops, then put the operation mode of the power switch in OFF.
- Do not store your vehicle at ambient temperatures above 131 °F (55 °C) for over 24 hours, or below -13 °F (-25 °C) for over 7 days. The temperatures may damage the main drive lithium-ion battery.

## EV cruising range

### NOTE

- It is recommended that your vehicle be stored at temperatures below 77 °F (25 °C) to help maximize the life of the main drive lithium-ion battery.

### Decrease of battery capacity

N01207100041

- The capacity of the main drive lithium-ion battery used on your OUTLANDER PHEV, like other commonly used lithium-ion batteries, will decrease according to time and usage. This type of decrease in battery capacity is normal, and is not indicative of any defect or failure in your main drive lithium-ion battery. As the main drive lithium-ion battery capacity decreases, the initial EV cruising range of the vehicle and the vehicle performance will similarly decrease. Also, when the ambient temperature is low, charging times get longer or charging may be stopped before complete charging.

- The capacity of your vehicle battery over time will depend on a variety of factors including how your vehicle is used, stored and charged. Factors that can adversely affect battery capacity over time include frequent driving using aggressive acceleration/deceleration, repeated frequent use of the quick charger, and operation/storage in extreme temperature environments.
- When the ambient temperature lowers, the engine will start frequently, even if there is a large amount of remaining power in the main drive lithium-ion battery.
- Because the engine starts frequently, the fuel consumption will increase.
- The main drive lithium-ion battery has a limited service life, and when its charging capacity falls, owners should bring their vehicle to a certified Mitsubishi EV dealer for inspection and possible battery replacement.
- For details regarding the warranty coverage for the main drive lithium-ion battery, refer to the Warranty and Maintenance Manual.

### NOTE

- It is not necessary to consume the main drive lithium-ion battery completely before charging.

### NOTE

- To help maintain the capacity of the main drive lithium-ion battery, the following is recommended:
  - If you repeatedly perform only the quick charging, fully charge the vehicle by normal charging once every approximately 2 weeks.
  - Do not repeat charging when the main drive lithium-ion battery is at or near the full charge.

### EV cruising range

N01207200026

The distance you can drive the vehicle (EV cruising range) depends on a number of factors including available charge, weather, temperature, usage, battery age, topography, and driving style. Your actual range can vary, either initially or as the battery ages and with use over time.

As the main drive lithium-ion battery capacity decreases, the EV cruising range of the vehicle will similarly decrease. Refer to “Decrease of battery capacity” on page 3-7.

### NOTE

- Since cooling or heating consumes power from the main drive lithium-ion battery, operation of these functions will reduce the EV cruising range.

General information/Charging 3-7

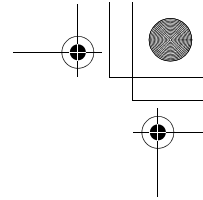
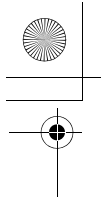

### EV cruising range

**3**

<p> <b>NOTE</b></p> <ul style="list-style-type: none"> <li>● Put the selector lever in the “B” (REGENERATIVE BRAKE) position according to the road condition. Using appropriate regenerative braking can help increase the EV cruising range. Refer to “Regenerative braking” on page 3-4.</li> </ul>
--

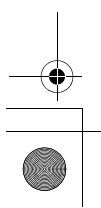
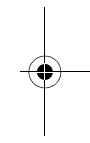
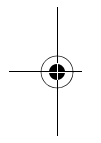

### 3-8 General information/Charging

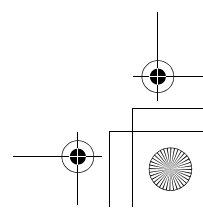
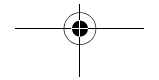
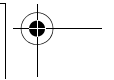



EV cruising range

**EV cruising range-Driving conditions**

N01207300027

Shorten driving range	← Driving range →	Lengthen driving range
Range Reducing	Condition	Range Extending
High acceleration, speed	Driving style	Low acceleration, speed
Heater on	Heater usage	Heater off (or use seat heater)
A/C on	A/C usage	A/C off
Highway	City/Highway	City
Heavy payload	Payload	Light payload
Windy, wet	Weather	Calm, dry
Uphill, rough	Road conditions	Flat/Downhill, smooth
“D” (DRIVE)	Select position	“B” (REGENERATIVE BRAKE)

**3**

## Operating sound under charging or Remote Climate Control

### Operating sound under charging or Remote Climate Control

3

N01207400031

While charging, even if the operation mode of the power switch is OFF, you may hear operating sounds from the cooling fan and air conditioning compressor when operating the main drive lithium-ion battery cooling system or Remote Climate Control (if so equipped). This is normal.  
Refer to “MITSUBISHI Remote Control” on page 3-38.

### For persons with electro-medical apparatus such as implantable cardiac pacemaker or implantable cardiovascular defibrillator

N01207500032

#### ⚠ WARNING

- Before charging, read the instructions described below carefully and follow them. Also read and follow the instructions for “Normal charging (charging method with rated AC 120 V outlet)” on page 3-20, “Normal charging (using 240 V Electric Vehicle Supply Equipment)” on page 3-31, and “Quick charging (charging method with quick charger)” on page 3-32.
- Before charging, individuals using an electro-medical apparatus such as implantable pacemakers and implantable cardiovascular-defibrillators should check with the manufacturer of the apparatus to confirm the effect of the electromagnetic waves from charging. The electromagnetic waves may affect the operations of the electro-medical apparatus.

#### ⚠ WARNING

- When performing normal charging, keep your electro-medical apparatus, such as implantable cardiac pacemaker or implantable cardiovascular defibrillator, away from the charge connector, EV charging cable, control box or normal charging station.
- Do not perform quick charging and keep away from a quick charger. Electromagnetic waves produced by a quick charger may affect the operation of your electro-medical apparatus. If you have accidentally approached a quick charger, walk away from the quick charger immediately. If quick charging is necessary, ask someone for help.
- While charging;
  - Do not stay inside the vehicle.
  - Do not go inside the vehicle, for example to remove or place an item in the passenger compartment.
  - Do not open the liftgate, for example to remove or place an item in the cargo area.
- Do not bring your body close to the foot area of the rear seat and do not stay in the cargo area while the vehicle is running. Also, do not allow persons using an electro-medical apparatus to ride in the cargo area while the vehicle is running. The operation of electro-medical apparatus may be affected.

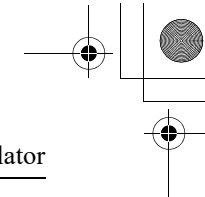
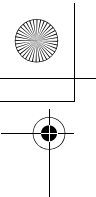

For persons with electro-medical apparatus such as implantable cardiac pacemaker or implantable cardiovascular defibrillator

**⚠ WARNING**

- When using the Free-hand Advanced Security Transmitter (F.A.S.T.-key), please observe following precautions.
- People with implantable cardiac pacemakers or implantable cardiovascular-defibrillators should not go near the external transmitters or the internal transmitters. The radio waves used by the F.A.S.T.-key could adversely affect implantable cardiac pacemakers or implantable cardiovascular-defibrillators.
- When using electromedical devices other than implantable cardiac pacemakers or implantable cardiovascular-defibrillators, contact the electromedical device manufacturer ahead of time to determine the affects of radio waves on the devices. Electromedical device operations could be adverse effects by radio waves. Refer to “Free-hand Advanced Security Transmitter (F.A.S.T.-key)” on page 5-4.

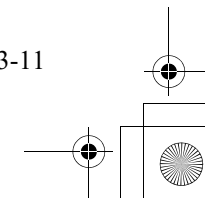
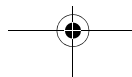
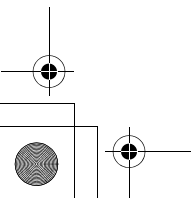
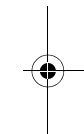
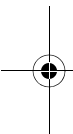

Cautions and actions to deal with intense heat

**Cautions and actions to deal with intense heat**

N01201001061

**3**

- When the ambient temperature is approximately 113 °F (45 °C) or higher, the phenomena described below may occur. Please take the described actions.
- Even if the ambient temperature is approximately 113 °F (45 °C) or lower, when performing quick charging, driving at high-speed and uphill repeatedly, the phenomena described below may occur. Please take the described actions.

Approx. ambient temperature	Phenomena		Corrective action
Approx. 113 °F (45 °C) or higher	Startup and driving	<ul style="list-style-type: none"> <li>● If quick charging and high-speed driving or quick charging and uphill driving are repeated, the “PROPULSION POWER IS REDUCED” warning display* may appear and the motor output is restricted to protect the main drive lithium-ion battery and/or motor.</li> <li>● If driving continues a few miles/kilometers while the “PROPULSION POWER IS REDUCED” warning display* appears, the vehicle may stop.</li> </ul>	Stop the vehicle in a safe place for a while, avoid quick charging, and wait for the “PROPULSION POWER IS REDUCED” warning display* to go off.
		Regenerative braking performance may decrease.	
	Charging and battery	<ul style="list-style-type: none"> <li>● The EV charging cable cannot be used.</li> <li>● Charging times get longer.</li> </ul>	Park in a safe, well-ventilated and shady place.
		The main drive lithium-ion battery capacity is decreased more quickly, and the EV cruising range is decreased.	

 **NOTE**

● \*: Refer to “PROPULSION POWER IS REDUCED” warning display on page 5-181. Display of the “PROPULSION POWER IS REDUCED” warning display does not indicate a malfunction.

## Cautions and actions to deal with intense cold

**Cautions and actions to deal with intense cold**

N01201101075

- When the ambient temperature is approximately 5 °F (-15 °C) or lower, the phenomena described below may occur. Please take the corrective actions described below.

**3**

Approx. ambient temperature	Phenomena		Corrective action
Approx. 5 °F (-15 °C) or lower	Startup and driving	Motor output is restricted and the vehicle performance may be decreased.	Keep driving if you can drive at a safe speed. If you cannot drive at a safe speed, stop the vehicle in a safe place and charge the main drive lithium-ion battery.
		Regenerative braking performance may decrease.	When braking, depress the brake pedal more strongly.
	Charging and battery	<ul style="list-style-type: none"> <li>● Charging times get longer.</li> <li>● Complete charging may not be possible.</li> </ul>	When you have finished driving, charge the main drive lithium-ion battery before ambient temperature falls to 5 °F (-15 °C) or lower.

## Cautions and actions to deal with intense cold

3

Approx. ambient temperature	Phenomena		Corrective action
Approx. -18 °F (-28 °C) or lower	Startup and driving	The motor output is restricted and the vehicle performance may be decreased. Then, the “PROPULSION POWER IS REDUCED” warning display* <sup>1</sup> and “BATTERY TOO COLD” warning display* <sup>2</sup> may appear alternately. (Vehicles with main drive lithium-ion battery warming system)	Keep driving if you can drive at the same speed as surrounding vehicles. If you cannot drive the same speed as surrounding vehicles, stop the vehicle in a safe place.
		The vehicle performance decreases, the “BATTERY TOO COLD FOR VEHICLE TO OPERATE” warning display* <sup>3</sup> may appear.	In the daytime, wait for the temperature to rise. When the temperature in the vicinity of the main drive lithium-ion battery has risen, start up.
		Regenerative braking performance may decrease or be eliminated.	When braking, depress the brake pedal more strongly.
	Charging and battery	Charging may become impossible. (Except for vehicles with main drive lithium-ion battery warming system)	When you have finished driving, charge the main drive lithium-ion battery before ambient temperature falls to -18 °F (-28 °C) or lower.
		<ul style="list-style-type: none"> <li>● Charging times get longer.</li> <li>● Complete charging may not be possible. (Vehicles with main drive lithium-ion battery warming system)</li> </ul>	If low temperature is predicted, even if the main drive lithium-ion battery is fully charged, connect the EV charging cable. The main drive lithium-ion battery will automatically be warmed.

Cautions and actions to deal with intense cold

Approx. ambient temperature	Phenomena		Corrective action
Approx. -22 °F (-30 °C) or lower	Startup and driving	The Plug-in Hybrid EV system may not be started and “BATTERY TOO COLD” warning display*2 may appear. (Except for vehicles with main drive lithium-ion battery warming system)	In the daytime, wait for the temperature to rise. When the temperature in the vicinity of the main drive lithium-ion battery has risen, start up.
		The Plug-in Hybrid EV system may not be started. The ready indicator*4 blinks and “BATTERY TOO COLD PLUG IN NORMAL CHARGER TO WARM” warning display *5 may appear. (Vehicles with main drive lithium-ion battery warming system)	If low temperature is predicted, even if the main drive lithium-ion battery is fully charged, connect the EV charging cable (normal charger). The main drive lithium-ion battery will automatically be warmed. The Plug-in Hybrid EV system can be started within 1 hour after the EV charging cable is connected.
		Regenerative braking performance may decrease or be eliminated.	When braking, depress the brake pedal more strongly.
		The vehicle performance decreases, the “BATTERY TOO COLD FOR VEHICLE TO OPERATE” warning display*3 may appear.	In the daytime, wait for the temperature to rise. When the temperature in the vicinity of the main drive lithium-ion battery has risen, start up.
	Charging and battery	Charging may become impossible. (Except for vehicles with main drive lithium-ion battery warming system)	In the daytime, wait for the temperature to rise. When the temperature in the vicinity of the main drive lithium-ion battery has risen, begin charging.
		<ul style="list-style-type: none"> <li>● Charging times get longer.</li> <li>● Complete charging may not be possible. (Vehicles with main drive lithium-ion battery warming system)</li> </ul>	If low temperature is predicted, even if the main drive lithium-ion battery is fully charged, connect the EV charging cable. The main drive lithium-ion battery will automatically be warmed.

3

## Cautions and actions to deal with intense cold

### CAUTION

- When “BATTERY TOO COLD FOR VEHICLE TO OPERATE” is displayed\*<sup>3</sup>, contact a certified Mitsubishi EV dealer.

## 3

### NOTE

- \*<sup>1</sup>: Refer to “PROPULSION POWER IS REDUCED” warning display on page 5-181.  
Display of the “PROPULSION POWER IS REDUCED” warning display does not indicate a malfunction.
- \*<sup>2</sup>: Refer to “BATTERY TOO COLD” warning display on page 5-162.
- \*<sup>3</sup>: Refer to “BATTERY TOO COLD FOR VEHICLE TO OPERATE” warning display on page 5-162.
- \*<sup>4</sup>: Refer to “Ready indicator” on page 5-187.
- \*<sup>5</sup>: Refer to “BATTERY TOO COLD PLUG IN NORMAL CHARGER TO WARM” warning display on page 5-162.
- When warming the main drive lithium-ion battery with the main drive lithium-ion battery warming system (if so equipped), use the EV charging cable. If using a home charging device or a public charging device (EVSE: Electric Vehicle Supply Equipment), charging and warm-up of the main drive lithium-ion battery may be stopped. If this happens, disconnect the charge connector and insert the charge connector again.  
Accordingly, the main drive lithium-ion battery warming system will be reactivated and you can start the Plug-in Hybrid EV system within 1 hour.
- The main drive lithium-ion battery warming system may not be activated depending on the situation.
- While warm up the main drive lithium-ion battery, the following phenomena may occur.
  - The operation sound of on board equipment and the state of charge is displayed on the multi-information display.
  - The main drive lithium-ion battery may not become full charge.



## Charging

N01201201092

Your vehicle comes standard with a charge port and charging cable (EV charging cable) that uses a household outlet (AC 110-120 V) as a charging source. You may also charge your vehicle using an OUTLANDER PHEV compatible 220-240 V charging device (EVSE\*<sup>1</sup> - available separately). As an optional feature, your vehicle may come equipped with an additional quick charge port to be used with a CHAdeMO\*<sup>2</sup> quick charger.

3

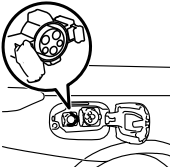
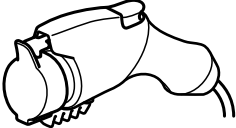
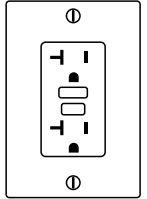
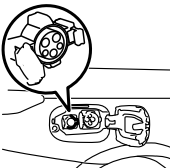
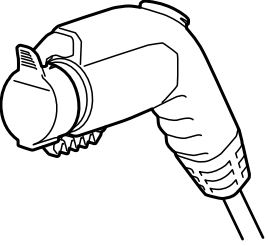
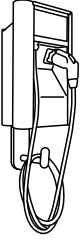
Category	Charge port	Charge connector	Charging Source	Charging time	Reference
Level 1 Normal charging 110-120 V (Attached EV charging cable)	 <p>Right rear side of vehicle</p>		 <p>110-120 V household outlet (15 amp dedicated circuit required)</p>	120 V/8 A: Approximately 14.5 hours 120 V/12 A: Approximately 9 hours	P.3-20
Level 2 Normal charging 220-240 V (Primary Home EVSE* <sup>1</sup> Dock-Available separately)	 <p>Right rear side of vehicle</p>		 <p>Home or public charging device</p>	Approximately 4 hours	P.3-31

### Charging

**3**

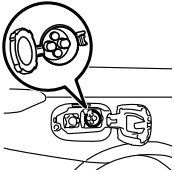
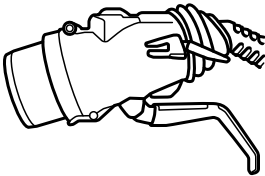
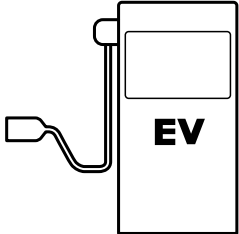
Category	Charge port	Charge connector	Charging Source	Charging time	Reference
Quick charging (charging method with quick charger)*3	 <p>Right rear side of vehicle</p>		 <p>Public charging stations where available</p>	Approximately 25 minutes for 80 % charge	P.3-32

\*1: EVSE = Electric Vehicle Supply Equipment

\*2: CHAdeMO is a standard for quick charging of electric vehicle originally started in Japan, and the contents have also become international standard.

\*3: Optional equipment

Charging time will vary depending on the condition of the main drive lithium-ion battery, air temperature, electric power consumption of electrical devices during charging and condition of the power source (such as specifications of the quick charger). A vehicle equipped with a quick charge port is compatible with most CHAdeMO connectors on charging stations. Charging stations using the CHAdeMO standard are UL certified and safe to use in the US. For details of charging system specifications, refer to “Charging system specifications” on page 11-7.

**NOTE**

- The main drive lithium-ion battery can be charged to nearly full using the battery charge mode. Refer to “SAVE/CHARGE mode switch” on page 5-68.

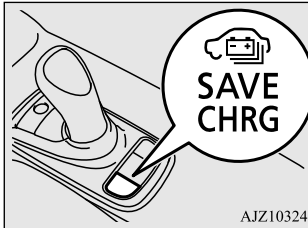

AJZ103245

**NOTE**

- The 12 V starter battery will be automatically charged during charging and also while the ready indicator is illuminated. Refer to “Ready indicator” on page 5-187.
- Repeatedly performing only quick charging can reduce battery capacity. Normal charging is recommended unless quick charging is necessary.
- If the 12 V starter battery is discharged, the main drive lithium-ion battery cannot be charged. Refer to “Jump-starting the Plug-in Hybrid EV system” on page 8-2.

## Precautions during Charging the Main Drive Lithium-ion Battery

**NOTE**

- Both normal charging and quick charging cannot be performed at the same time. The quick charging is given priority.

**Precautions during Charging the Main Drive Lithium-ion Battery**

N01202601080

**WARNING**

- **Improper charging can result in a fire, property damage, and serious injury or death.**  
Read the instructions described below carefully and follow them. Also read and follow the instructions for “Normal charging (charging method with rated AC 120 V outlet)” on page 3-20, Normal charging (using 240 V Electric Vehicle Supply Equipment) on page 3-31 and “Quick charging (charging method with quick charger)” on page 3-32 before using the charging device.
- **Do not touch charge port, charge connector, plug and outlet with wet hands.**
- **Keep away from water when connecting the charge port, charge connector, plug and outlet.**

**WARNING**

- **Do not perform charging outdoors in adverse weather, such as heavy rain, heavy snow or strong winds, or when adverse weather is expected.**
- **Never charge or touch the vehicle when lightning or thunder is observed or expected. A lightning strike may back feed into the normal charging causing damage and possible personal injury or death. If lightning or thunder begins during normal charging, do not touch the vehicle or the EV charging cable and turn off the breaker.**
- **Make sure there is no water or foreign materials in the charge port, charge connector or plug, and that they are not damaged or affected by rust or corrosion. If any of these conditions are noticeable, do not charge the main drive lithium-ion battery.**
- **Never touch the metal contacts of the charge port, charge connector or plug.**
- **Never disassemble or modify the charge port or charging cable.**
- **If you notice unusual odor or smoke coming from the vehicle, charging cable or plug, or if the charging cable or plug becomes hot to the touch, stop charging immediately.**

**WARNING**

- **Keep away from the cooling fan under the hood during charging. During charging, the cooling fan may automatically be operated even if the operation mode of the power switch is put in OFF.**
- **Some public chargers may not be compatible with your vehicle. If you attempt to charge from a non-compliant charger, you may not be able to charge or you may not receive a complete charge. If necessary, consult an administrator or the maker of the charger to determine whether the charger is compatible with your vehicle before using it. Also be sure to use the charger according to operating procedures indicated on the body of the charger.**

**3****CAUTION**

- **To prevent damage to the charging equipment:**
  - Do not close the charging port lid without closing the inner lid.
  - Do not subject the charging equipment to impact.
  - Do not pull, twist or bend the EV charge cable.
  - Do not drag the EV charge cable.
  - Do not store charging equipment in locations where the temperature is above 185 °F (85 °C) or below -40 °F (-40 °C).

### Normal charging (charging method with rated AC 120 V outlet)

3

#### CAUTION

- Do not place the charging equipment close to a heater or other heat source.
- Make sure the inner lid is closed on the charge port when charging is finished. If the charging lid is closed when the inner lid is open, water or foreign materials may enter the charge port.
- When charging, do not use a car cover except for the Mitsubishi Motors genuine car cover.
- Do not attempt to perform a jump start on the 12 V starter battery at the same time that the main drive lithium-ion battery is being charged. Doing so may damage the vehicle or EV charging cable and could cause an injury. See “Jump-starting” in the “6. For emergency” section.
- Forcing the charge connector to connect may cause damage to the charging equipment and vehicle.

#### NOTE

- If the charging lid is opened with the operation mode of the power switch in ON, a buzzer will intermittently sound for approximately 10 minutes to alert that charging has been disabled. When the charging lid is closed or the operation mode is put in OFF, the buzzer will stop.

#### NOTE

- If a charge connector is connected to the charge port with the operation mode of the power switch in ON, a buzzer will continuously sound for approximately 10 minutes to alert that charging has been disabled. When the charge connector is detached from the charge connector or the operation mode of the power switch is put in OFF, the buzzer will stop.
- Repeatedly performing only quick charging can reduce the main drive lithium-ion battery capacity. Normal charging is recommended unless quick charging is necessary.
- While charging, even if the operation mode of the power switch is OFF, you may hear operating sounds from the cooling fan and air conditioning compressor when operating the main drive lithium-ion battery cooling system or Remote Climate Control. This is normal. Refer to “MITSUBISHI Remote Control” on page 3-38.

#### NOTE

- If your vehicle is not used for a long time, check the gauge of the main drive lithium-ion battery level display at least once every 3 months.  
If the gauge of the main drive lithium-ion battery level display in the multi-information display indicates that the battery level is completely empty, charge the main drive lithium-ion battery until an indication appears in the gauge. Refer to “Multi-information display on page 5-140. Alternatively, start the Plug-in Hybrid EV System. Then the engine will automatically start to charge the main drive lithium-ion battery. Wait until the engine automatically stops, then put the operation mode of the power switch in OFF.
- If an electrical power outage occurs while charging, the charging will automatically resume when the electric power resumes.

### Normal charging (charging method with rated AC 120 V outlet)

N01203101066

Carefully read instructions regarding “Precautions during Charging the Main Drive Lithium-ion Battery” on page 3-19 and described in this section and also instructions on “EV charging cable” on page 3-28 or instructions for a charging device you use, and follow them.

## Normal charging (charging method with rated AC 120 V outlet)

**⚠ WARNING**

- Improper charging can result in a fire, property damage, and serious injury or death.
- To minimize the risk of electrical shock and/or a fire, always use an outlet rated AC 120 V that is grounded, protected by a ground-fault circuit interrupter, rated for 15 A or more, and connected to a dedicated circuit. Outlets located outdoors must be waterproofed. If you have any doubt whether your charging outlet meets these requirements, check with a licensed electrician.  
If the outlet is not grounded, the risk of electrical shock will increase in the event of an insulation failure in the EV charging cable.  
If the circuit is shared, and another electrical device is being used at the same time the vehicle is charging, the circuit may heat abnormally, the breaker may trip and the circuit may cause adverse interference on household electrical appliances such as televisions and audio systems.
- Individuals using an electro-medical apparatus such as implantable pacemakers and implantable cardiovascular-defibrillators should check with the manufacturer of the apparatus to confirm the effect of the electromagnetic waves from charging. The electromagnetic waves may affect the operations of the electro-medical apparatus.

**⚠ WARNING**

- If you use an electro-medical apparatus, such as an implantable cardiac pacemaker or an implantable cardiovascular defibrillator, observe the following precautions before charging;
  - Keep your electro-medical apparatus away from the charge connector, EV charging cable, control box and normal charging station.
  - While normal charging;
    - Do not stay inside the vehicle.
    - Do not return to the vehicle.
    - Do not open the liftgate, for example to remove or place an item in the cargo area.
- Never use an extension cable, multi-plug adapter or conversion adapter. Using them may cause overheating resulting in fire.
- Never force the connection if the EV charging cable or plug shows damage or is not easily connected due to foreign material entering the plug or the outlet.
- Never use an outlet that is damaged or will not hold the plug firmly in place. Never use a plug that is bent or damaged. Failure to follow these instructions can result in an electric shock and/or fire.
- Make sure that the plug is inserted all the way into the outlet before use.

**⚠ WARNING**

- While it is normal for the plug and EV charging cable to become warm during charging, discontinue use immediately if the plug or EV charging cable becomes too hot to touch.
- Never pull the cable to remove the plug.
- Never connect or disconnect the plug with a wet hand.

**3****⚠ CAUTION**

- During charging, the cooling fans in the engine compartment may automatically be operated even if the operation mode of the power switch is in OFF. Keep your hands away from the cooling fan during charging.
- Do not perform charging from other power source like a generator. Doing so could cause a malfunction.
- Do not push the rear portion of the charging lid when the charging lid is locked. There is a possibility that the charging lid open unexpectedly when the driver's door is unlocked.

**📖 NOTE**

- Your vehicle is equipped with an EV charging cable for normal charging. Refer to "EV charging cable" on page 3-28.

3

## Normal charging (charging method with rated AC 120 V outlet)

### NOTE

- When connecting or disconnecting the normal charge connector, insert/pull out the connector straight. Also, do not incline or twist the connector. Doing so could cause a bad connection or malfunction.
- Make sure to lock the doors to prevent theft, etc. during charging.

### Charging port courtesy light

N01216201045

The charging port courtesy light (A) illuminates when the charging lid is opened while the select position is in “P” (PARK) position. It goes off automatically after approximately 3 minutes.

If you want to turn it on again, press the charging port courtesy light switch (B). When charging is started, the charging port courtesy light blinks three times.

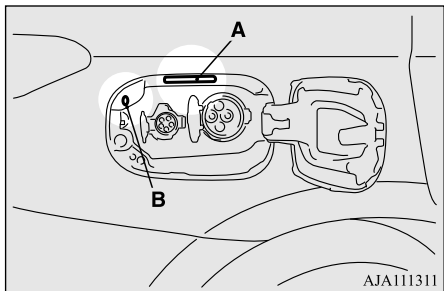

### NOTE

- The charging port courtesy light illuminating time can be adjusted. For details, please consult a certified Mitsubishi EV dealer.
- If the MITSUBISHI Remote Control (if so equipped) is operated when the charging port courtesy light is off, the light may illuminate.

### To open the charging lid

N01216500025

1. Firmly apply the parking brake, press the electrical parking switch to shift the “P” position and put the operation mode of the power switch is in OFF.
2. On vehicle equipped with the charging lid lock, unlock the driver’s door to unlock the charging lid.
3. Push the rear portion of the charging lid (A) until it clicks, and open the charging lid.

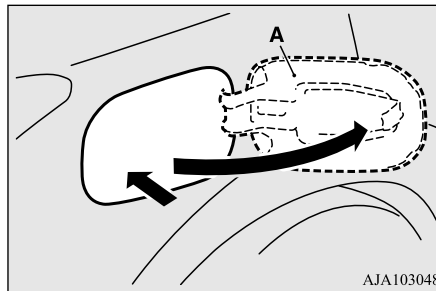

### NOTE

- On vehicles equipped with the charging lid lock, the charging lid is unlocked in conjunction with unlocking of the driver’s door as the following condition.
  - The operation mode is put in “OFF” or “ACC”.
  - The selector lever position is “P” (PARK).
- On vehicles equipped with the charging lid lock, when the charging lid cannot be unlocked even if the driver’s door is unlocked. Open the charging lid manually by using the release lever inside of the interior trim in the cargo room. Refer to “If the charging lid cannot be unlocked” on page 3-26.

### Charging from rated AC 120 V outlet

N01203201113

1. Open the charging lid.

Refer to “To open the charging lid” on page 3-22.

Normal charging (charging method with rated AC 120 V outlet)

2. Press the tab (A) to open the inner lid (B).

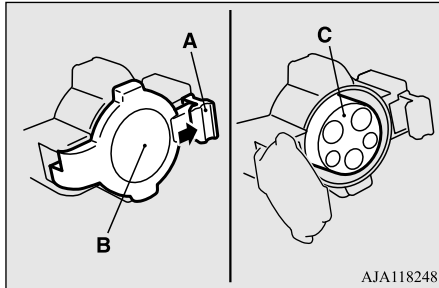

**WARNING**

- Do not touch the metal terminal of the normal charge port (C) and the normal charge connector. Doing so could cause an electric shock and/or malfunction.

**CAUTION**

- To help keep foreign material out of the normal charge port, do not leave the inner lid open without connecting the normal charge connector. Doing so could allow water, dirt or other objects to enter in the normal charge port resulting in a fire or electrical shock.

**NOTE**

- There is a hole on the normal charge port for water drainage. If this hole is blocked and water gets trapped in the normal charge port, do not charge. Contact a certified Mitsubishi EV dealer.
- If the normal charge port becomes frozen, use a hair dryer to defrost and dry the normal charge port before charging. Forcing the charging connector to connect with the normal charge port while it is frozen can damage the normal charge port and/or prevent charging.

3. Insert the EV charging cable plug into an outlet.

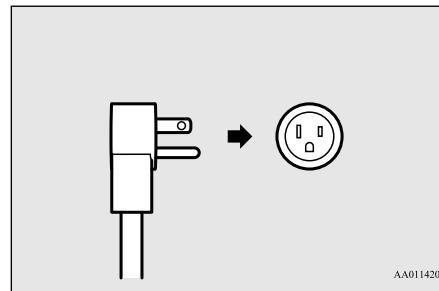

**WARNING**

- Make sure that the plug is inserted all the way into the outlet before use.

**WARNING**

- To minimize the risk of electrical shock and/or a fire, always use an outlet rated AC 120 V that is grounded, protected by a ground-fault circuit interrupter, rated for 15 A or more, and connected to a dedicated circuit. Outlets located outdoors must be waterproofed. If you have any doubt whether your charging outlet meets these requirements, check with a licensed electrician. If the outlet is not grounded, the risk of electrical shock will increase in the event of an insulation failure in the EV charging cable. If the circuit is shared, and another electrical device is being used at the same time the vehicle is charging, the circuit may heat abnormally, the breaker may trip and the circuit may cause adverse interference on the household electrical appliances such as televisions and audio systems.

3

### Normal charging (charging method with rated AC 120 V outlet)

3

**WARNING**

- Never use an extension cable, multi-plug adapter or conversion adapter. Using them may cause overheating resulting in fire.

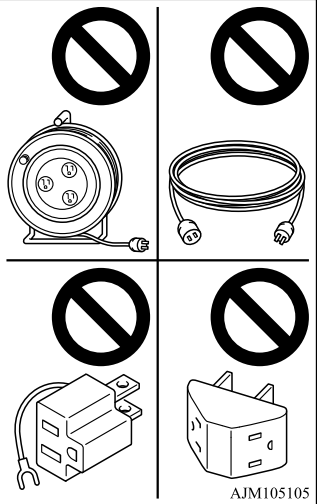

AJM105105

- To prevent an electrical shock or fire, do not use a multi type outlet. The grounded line may not work properly and it is not a dedicated type outlet.

4. Press the 8 A/12 A manual selection button (D) on the control box to charge quickly when needed. If selected, the 12 A indicator (E) will illuminate.

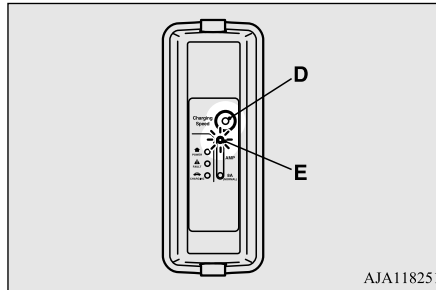

**WARNING**

- If the selected electrical current level exceeds the electrical current capacity of the electrical circuit or outlet being used for charging, the circuit and outlet can overheat resulting in fire. If the capacity of an outlet and its electrical circuit are unknown, do not use the outlet for charging the vehicle.

5. Open the cap (F) on the normal charge connector (G) and make sure that there is no foreign matter such as dust at the end of the normal charge connector and the normal charge port.

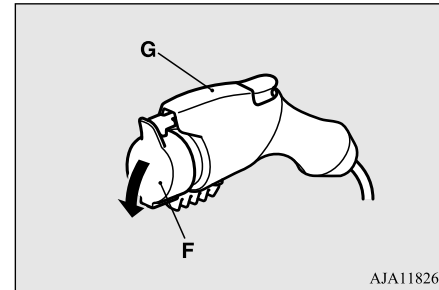

6. Without pressing the release button (H), insert the normal charge connector until a click is heard.

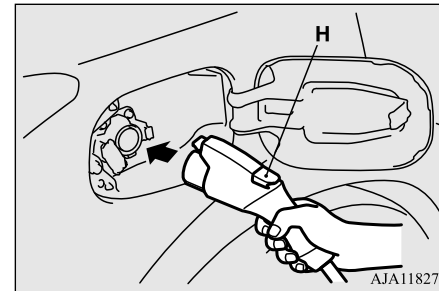



### Normal charging (charging method with rated AC 120 V outlet)

**CAUTION**

- Do not grasp the top of normal charge connector. It could cause injury from the protrusion on the charging lid.

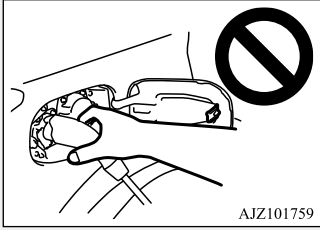

AJZ101759

**NOTE**

- If the operation mode of the power switch is put in ON with the EV charging cable connected to the normal charge port, the Plug-in hybrid EV system will not turn on.
- Do not connect or disconnect the normal charge connector repeatedly in a short time period. You may experience difficulty charging your vehicle.
- To change the operation mode of the power switch to "OFF" from "ACC" or "ON" after using an electric device, such as the audio system, during charging, make sure that the select position is in "P" (PARK) position, and press the power switch without depressing the brake pedal.

7. Make sure that the charging indicator (I) on the instrument cluster is illuminated.

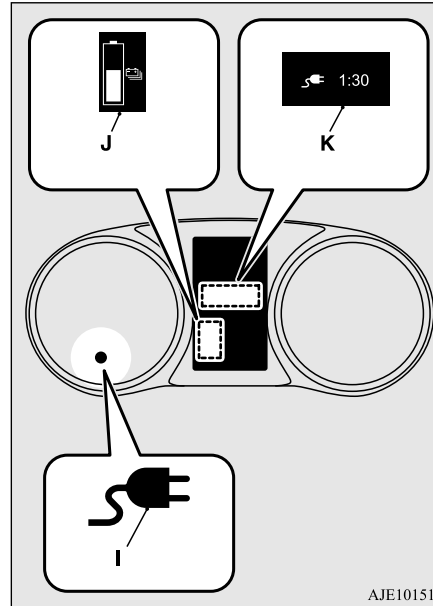

If the charging indicator is not illuminated, charging will not start. Make sure that the normal charge port, the plug and the connector are correctly connected, and perform charging from Step 4 again.

**NOTE**

- When the normal charge connector is connected to the normal charge port, the charging indicator is blinking. When charging is started, the charging indicator is illuminated and the charging port courtesy light blinks three times.
- If you want to confirm the main drive lithium-ion battery level or the predicted charging time during charging, one of the doors is opened or the multi-information display switch is operated, the main drive lithium-ion battery level display (J) appears and the predicted charging time display (K) appears on the information screen in the multi-information display. In addition, when the remaining time is less than 1 hour, the predicted charging time display appears --:--. This does not indicate a malfunction.
- When an electrical component is used during charging, charge time may become longer.
- You may hear operating sounds from the main drive lithium-ion battery cooling system, such as sounds from the cooling fan and air conditioning compressor, during normal charging. This is normal.

3

### Normal charging (charging method with rated AC 120 V outlet)

8. Charging is complete when the charging indicator turns off. Pull out the normal charge connector while pressing the release button (L).

3

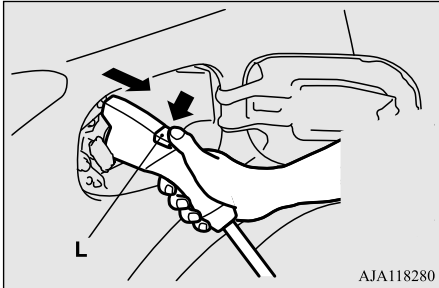

#### WARNING

- After charging, disconnect the charge connector completely from the normal charge port. If the normal charge connector remains partially engaged with the latch unlocked, the operation mode of the power switch can be put in ON and the vehicle can be moved.

#### NOTE

- Charging can be stopped half way. In this case, pull out the normal charge connector while pressing the release button.

9. Close the inner lid and press the rear of the charging lid until it clicks to close it.

#### WARNING

- After charging, be sure to close the inner lid and the charging lid completely. Be careful that water or dust does not enter in the normal charge port, inner lid and normal charge connector. Entry of water or dust could cause electric leakage, resulting in a fire or electric shock.

#### NOTE

- Make sure that the inner lid is completely closed before closing the charging lid. If the charging lid is forcibly closed without completely closing the inner lid, the hinge on the inner lid may be broken.
- When the operation mode of the power switch is put in ON while the charging lid is not completely closed, a warning may be displayed on the information screen in the multi-information display. Refer to “Warning display list” on page 5-162.
- On the vehicle equipped with the charging lid lock, if the charging lid is closed while the driver’s door is locked, the charging lid will be locked.

10. Remove the EV charging cable plug from the outlet.  
11. Install the cap on the normal charge connector.

#### CAUTION

- Before using an automatic car wash, make sure that the charging lid is completely closed to avoid damage to the charging lid.

### If the charging lid cannot be unlocked

N0121640024

When the charging lid cannot be unlocked even if the driver’s door is unlocked, take the following measure to open the charging lid.

1. Firmly apply the parking brake, press the electrical parking switch to shift the “P” position and put the operation mode in OFF.
2. Press the tab (A) on the interior trim of the lid in the cargo room and remove the interior trim of the lid.

Normal charging (charging method with rated AC 120 V outlet)

3. Pull the lever (B) in the direction indicated by the arrow.  
The charging lid will be unlocked.

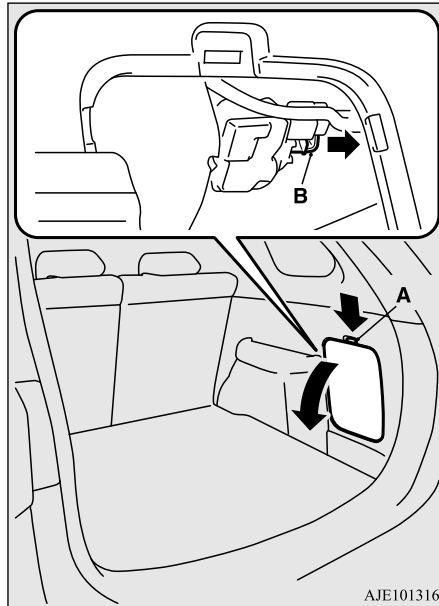

**NOTE**

- After taking the emergency measure, please inspect at a certified Mitsubishi EV dealer.

**Main drive lithium-ion battery warming system**

N01202501089

You cannot start the Plug-in Hybrid EV System and drive when the ambient temperature is  $-22^{\circ}\text{F}$  ( $-30^{\circ}\text{C}$ ) or lower (The warning display is displayed on the information screen in the multi-information display). The main drive lithium-ion battery warming system will automatically operate and the main drive lithium-ion battery will be heated when you connect the normal charge connector to the normal charge port.

Then, when the ambient temperature is higher  $-18^{\circ}\text{F}$  ( $-28^{\circ}\text{C}$ ), you can start the Plug-in Hybrid EV System and drive. The main drive lithium-ion battery warming system will automatically operate and the main drive lithium-ion battery will be heated when all the following conditions are met.

- The normal charge connector is connected to the normal charge port at an ambient temperature under  $-22^{\circ}\text{F}$  ( $-30^{\circ}\text{C}$ ).
- The Plug-in Hybrid EV System is started at an ambient temperature between  $-20^{\circ}\text{F}$  ( $-29^{\circ}\text{C}$ ) and  $14^{\circ}\text{F}$  ( $-10^{\circ}\text{C}$ ).

The main drive lithium-ion battery warming system will automatically stop after the main drive lithium-ion battery has been heated until suitable temperature.

3

**NOTE**

- When the ambient temperature is very cold, you cannot use function of charging timer because of operating the main drive lithium-ion battery warming system. And when the ambient temperature is  $-22^{\circ}\text{F}$  ( $-30^{\circ}\text{C}$ ) or lower, you cannot use the function of the remote climate control. Then, when the ambient temperature is higher  $-20^{\circ}\text{F}$  ( $-29^{\circ}\text{C}$ ) after operating the main drive lithium-ion battery warming system, you can use the function of the remote climate control.

## EV charging cable

### EV charging cable

N01202801066

**3**

Your vehicle is equipped with an EV charging cable that consists of a cable (A), control box (B), plug (C), and normal charge connector (D). The EV charging cable is stowed in the luggage floor box. Refer to “Luggage floor box” on page 5-225.

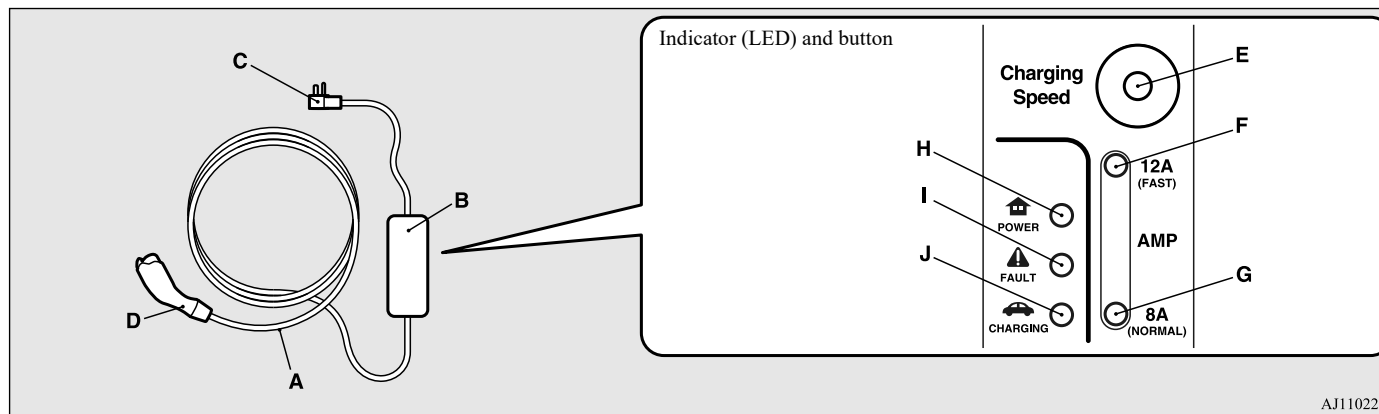

AJ1102283

E- 8 A/12 A manual selection button  
 F- 12 A indicator  
 G- 8 A indicator

H (🏠)- POWER indicator  
 I (⚠️)- FAULT indicator  
 J (🚗)- CHARGING indicator

For a quicker charge, press the 8 A/12 A manual selection button (E) and confirm that the 12 A indicator (F) is illuminated. Each time you press the button, either the 12 A indicator or the 8 A indicator (G) will illuminate. POWER (H), FAULT (I) and CHARGING (J) indicators located on the control box will illuminate/blink in response to the following conditions:

EV charging cable

○: Illuminates ◎: Blinking ●: Not illuminated

POWER 🏠	FAULT ⚠️	CHARGING 🚗	Operating condition
○	○	○	Every time the EV charging cable plug (C) is connected to an outlet, all indicator lights illuminate for 1/2 second, then go out.
○	●	●	After initial processing is completed, when the normal charge connector is not connected to the normal charge port, or the normal charge connector is connected to the normal charge port but charging is not being performed.
○	●	○	While the main drive lithium-ion battery is being charged
◎	◎	●	When the ground cable is disconnected Check the grounding of the outlet being used. If the outlet is properly grounded, contact a certified Mitsubishi EV dealer.
○	●	◎	When charging is completed.

3

POWER 🏠	FAULT ⚠️	CHARGING 🚗	Abnormal operating condition and corrective action
○	◎	●	When an electric leakage occurs or the EV charging cable malfunctions. Stop use immediately and contact a certified Mitsubishi EV dealer.
○	○	●	When the EV charging cable malfunctions. Stop use immediately and contact a certified Mitsubishi EV dealer.
●	●	●	If the control box indicator light does not illuminate after connecting the EV charging cable plug to the outlet, check the circuit breaker for the outlet. If the breaker has tripped, the circuit may not be suitable for use with EV charging cable. You should have a licensed electrician inspect and repair the electrical circuit. If the breaker is not tripped, stop using the EV charging cable and contact a certified Mitsubishi EV dealer.

## EV charging cable

3

### ⚠ WARNING

- Improper use of the EV charging cable can result in a fire, property damage, and serious injury or death. Carefully read instructions regarding “Precautions during Charging the Main Drive Lithium-ion Battery” on page 3-19 and on “Normal charging (charging method with rated AC 120 V outlet)” on page 3-20 and described in this section and follow them.
- To minimize the risk of electrical shock and/or a fire, always use an outlet rated AC 120 V that is grounded, protected by a ground-fault circuit interrupter, rated for 15 A or more, and connected to a dedicated circuit. Outlets located outdoors must be waterproofed. If you have any doubt whether your charging outlet meets these requirements, check with a licensed electrician.
- Never use an extension cable or conversion adapter.
- Never connect or disconnect the plug with a wet hand.
- Make sure that the plug is inserted all the way into the socket before use. Continued charging with a plug not completely inserted or pulled halfway out of the socket may result in a risk of overheating or fire.

### ⚠ WARNING

- If the indicators show the EV charging cable malfunctions as described below, stop using the EV charging cable and contact a certified Mitsubishi EV dealer.
- Never disassemble the EV charging cable or attempt to open the control box.

### 📖 NOTE

- All indicators are illuminated momentarily for confirming operation when the EV charging cable plug is inserted into an outlet. After that, the POWER indicator is continuously illuminated and the CHARGING indicator is continuously blinking.
- The CHARGING indicator will start to blink when charging is completed. The POWER indicator is continuously illuminated while EV charging cable plug is inserted into an outlet.

## Handling and storing the control box

N01202901067

### ⚠ CAUTION

- Use the method shown below to help secure the control box and to prevent the plug from being pulled halfway out of the socket during charging.

### 📖 NOTE

- Use customer supplied hook (A) and rope (B) supplied with the vehicle, that can support the weight of the EV charging control box, 8.8 lbs (4 kg) as shown in the figure below.
- Make sure that the rope has no damage before use.
- Never at any time should the EV charging control box be solely supported by the power cord plugged into a socket. Doing so may cause strain and/or damage on the electrical outlet/plug.

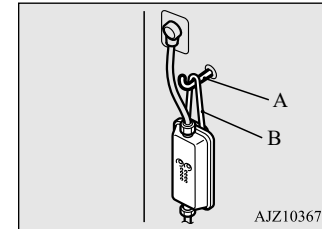

FCC Notice: This equipment has been tested and found to comply with the limits for a Class B digital device, pursuant to part 15 of the FCC Rules. These limits are designed to provide reasonable protection against harmful interference in a residential installation. This equipment generates, uses and can radiate radio frequency energy and, if not installed and used in accordance with the

## Normal charging (using 240 V Electric Vehicle Supply Equipment)

instructions, may cause harmful interference to radio communications.

However, there is no guarantee that interference will not occur in a particular installation. If this equipment does cause harmful interference to radio or television reception, which can be determined by turning the equipment off and on, the user is encouraged to try to correct the interference by one or more of the following measures:

- Reorient or relocate the receiving antenna.
- Increase the separation between the equipment and receiver.
- Connect the equipment into an outlet on a circuit different from that to which the receiver is connected.
- Consult the dealer or an experienced radio/TV technician for help.

ICES Notice: This Class B digital apparatus complies with Canadian ICES-003.

### Cleaning the EV charging cable

N01203001023

1. Gently wipe outside surface of the EV charging cable with gauze or a similar soft cloth soaked with a mild soap and water solution.
2. Wipe off all detergent with a soft cloth dipped in fresh water and thoroughly wrung out.

3. Wipe all moisture off and dry in a shaded, well-ventilated area.

#### ⚠ WARNING

- **Before cleaning, be sure to remove the EV charging cable plug from the socket and the normal charging connector from the vehicle. Do not connect or disconnect the plug with a wet hand. Doing so can cause an electric shock.**
- **Never expose the metal terminal of the normal charge connector or the EV charging cable plug to water or neutral detergent. Water or detergent entering into the plugs can cause a fire or an electric shock.**

#### ⚠ CAUTION

- Never use benzine, gasoline, organic solvents, acid, or alkaline solvents to clean the charging cable. Doing so could cause deformation, discolor, or malfunction. Also, these substances may be present in various cleaners, so check carefully before use.

### Normal charging (using 240 V Electric Vehicle Supply Equipment)

N01216101031

3

You can charge your vehicle through the normal charge port using 240 V Electric Vehicle Supply Equipment (EVSE) compatible with OUTLANDER PHEV.

Carefully read instructions on “Precautions during Charging the Main Drive Lithium-ion Battery” on page 3-19, described in this section.

For connecting/disconnecting the charging connector to/from the vehicle, follow instructions for the normal charging (charging method with rated AC 120 V outlet) on page 3-20. Also, Mitsubishi Motors recommends that all 240 V home charging docks be installed by a licensed professional electrician using a dedicated circuit. Please review and follow the instructions provided with your charging dock.

## Quick charging (charging method with quick charger) (if so equipped)

3

### WARNING

- Individuals using an electro-medical apparatus such as implantable pacemakers and implantable cardiovascular-defibrillators should check with the manufacturer of the apparatus to confirm the effect of the electromagnetic waves from charging. The electromagnetic waves may affect the operations of the electro-medical apparatus.
- If you use an electro-medical apparatus, such as an implantable cardiac pacemaker or an implantable cardiovascular defibrillator, observe the following precautions before charging;
  - Keep your electro-medical apparatus away from the charge connector, EV charging cable, control box and normal charging station.
  - While normal charging;
    - Do not stay inside the vehicle.
    - Do not get in the vehicle (including the cargo area) to take out something or for other purpose.
    - Do not open the liftgate, for example to remove or place an item in the cargo area.

### WARNING

- Do not bring your body close to the foot area of the rear seat and do not ride in the cargo area while the vehicle is running. Also, do not allow persons using an electro-medical apparatus to ride in the cargo area while the vehicle is running. The operation of electro-medical apparatus may be affected.

### CAUTION

- Be sure to use a 240 V EVSE compatible with OUTLANDER PHEV. Use of a non-compatible 240 V EVSE may not charge the main drive lithium-ion battery correctly or may damage the main drive lithium-ion battery.

### NOTE

- The 240 V EVSE compatible with OUTLANDER PHEV is available separately. Contact a certified Mitsubishi EV dealer.

## Quick charging (charging method with quick charger) (if so equipped)

N01203301084

As an optional feature, your vehicle may come equipped with an additional quick charge port. The quick charge port is compatible with most CHAdeMO\* connectors on charging stations.

\*: CHAdeMO is a standard for quick charging of electric vehicle originally started in Japan, and the contents have become an international standard. Charging stations using this standard are UL certified and safe to use in the US.

Improper charging can result in a fire, property damage, and serious injury or death. Carefully read and follow instructions on “Precautions during Charging the Main Drive Lithium-ion Battery” on page 3-19, instructions described in this section and also instructions for the quick charger you use.

### WARNING

- Always use a CHAdeMO quick charger. Use of a non-CHAdeMO quick charger may cause a fire or malfunction. When operating a quick charger, follow the instructions provided with the quick charger.



## Quick charging (charging method with quick charger) (if so equipped)

### ⚠ WARNING

- If you use an electro-medical apparatus, such as implantable cardiac pacemaker or an implantable cardiovascular defibrillator, follow the precautions described below. Quick charging may affect the operation of electric medical devices.
- Do not perform quick charging and keep away from a quick charger. Electromagnetic waves produced by a quick charger may affect the operation of your electro-medical apparatus.
- If you have accidentally approached a quick charger, walk away from the quick charger immediately.
- If quick charging is necessary, ask someone for help.
- While quick charging;
  - Do not stay inside the vehicle.
  - Do not go inside the vehicle, for example to remove or place an item in the passenger compartment.
  - Do not open the liftgate, for example to remove or place an item in the cargo area.
- Never connect or disconnect the charger with a wet hand.
- Never pull the cable to disconnect the charger.
- During charging, the cooling fans under the hood may automatically operate even if the operation mode of the power switch is OFF. Keep your hands away from the cooling fans during charging.

### ⚠ WARNING

- As the quick charge connector is heavier in comparison to the normal charge connector, allowing it to drop could cause damage to the vehicle or charge connector or personal injury.

### ⚠ CAUTION

- If the charge connector cannot easily be connected to the quick charge port, do not force the connection. Foreign material may be in the charge connector or quick charge port, or the charging device may not be compatible with your vehicle. Contact a certified Mitsubishi EV dealer.

### 📖 NOTE

- Repeatedly performing only quick charging can reduce the main drive lithium-ion battery capacity. Normal charging is recommended unless quick charging is necessary.
- Before using a publicly available quick charger, confirm that the charger is suitable for your vehicle.
- Make sure to lock the doors to prevent theft, etc. during charging.

### 📖 NOTE

- When using a quick charger, make sure that the time available is enough so that the quick charging can be finished in the time available.
- If the power supply to the quick charger is shut off during quick charging, it could lead to a malfunction.

3

1. Open the charging lid.  
Refer to “To open the charging lid” on page 3-22.
2. Press the tab (A) to open the inner lid (B).

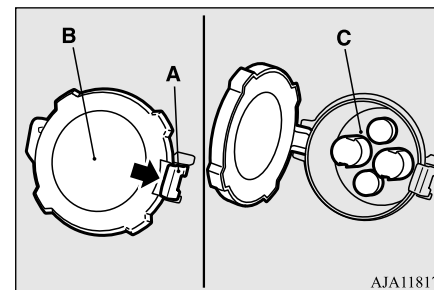

### ⚠ WARNING

- Do not touch the metal terminal of the quick charge port (C) or the quick charge connector. Doing so could cause an electric shock and/or malfunction.

### Quick charging (charging method with quick charger) (if so equipped)

**3**

#### **CAUTION**

- Be sure to insert the quick charge connector straight into the quick charge port all the way to the base. Failure to do so may result in the main drive lithium-ion battery not charging or cause damage to the charging equipment.
- Do not leave the inner lid open for any significant period of time without the charge connector inserted. Foreign material, if allowed to enter the quick charge port, can damage the quick charge port and/or prevent charging.

#### **NOTE**

- There is a hole on the quick charge port for water drainage. If this hole is blocked and water gets trapped in the quick charge port, do not charge. Contact a certified Mitsubishi EV dealer.
- If the quick charge port becomes frozen, use a hair dryer to defrost and dry it before charging. Forcing the charging connector into the quick charge port while it is frozen can damage the quick charge port, and it may prevent charging.

3. Insert the quick charge connector completely into the quick charge port to begin charging.

For connecting and disconnecting, follow the instruction manual for each quick charger.

#### **WARNING**

- **Be sure to insert the charge connector completely into the quick charge port. If the charge connector is only partially inserted and the connector latch is not locked, the operation mode of the power switch can still be put in ON and the vehicle can still be moved.**

4. Make sure that the charging indicator (D) on the instrument cluster is illuminated.

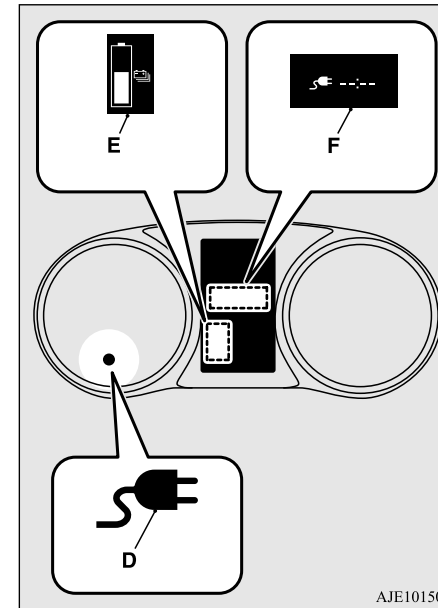

If the charging indicator is not illuminated, charging has not started. Refer to the quick charger user manual.

## Quick charging (charging method with quick charger) (if so equipped)

 **NOTE**

- When the quick charge connector is connected to the quick charge port, the charging indicator will blink. Once charging has started, the charging indicator will illuminate and the charging port courtesy light blinks three times.
- If you want to confirm the main drive lithium-ion battery level or the predicted charging time during charging, open one of the doors or operate the multi-information display switch, and the main drive lithium-ion battery level display (E) appears on the information screen in the multi-information display.  
Although the predicted charging time display (F) appears, the charging time for quick charging is approximately 30 minutes and displayed "--:--" in the screen and you cannot confirm the predicted charging time.
- When an electrical component is used during charging, charge time may become longer.
- You may hear operating sounds from the main drive lithium-ion battery cooling system, such as sounds from the cooling fan and air conditioning compressor, during quick charging. This is normal.
- Since the main drive lithium-ion battery cooling system uses cool air from the air conditioning system, the air conditioning will automatically be operated.  
After quick charging, you may find dehumidified water from the air conditioning system under the vehicle. This is normal.

5. Charging is complete when the charging indicator turns off.  
Disconnect the quick charge connector according to the manual of the quick charger.

 **CAUTION**

- Do not leave the quick charge connected to the quick charge port after charging. Someone might stumble on the charger or the quick charge port might get damaged.

 **NOTE**

- If quick charging has not completed normally, and the charging indicator continuously blinking, perform quick charging again and complete it normally.  
If the charging indicator is continuously blinking, contact a certified Mitsubishi EV dealer.

6. Close the inner lid and press the rear of the charging lid until it clicks to close it.

 **WARNING**

- **After charging, be sure to close the inner lid and the charging lid completely. Be careful that water or dust does not enter in the quick charge port, inner lid and quick charge connector. Entry of water or dust could cause a fire, electric shock or short circuit.**

 **NOTE**

- If the operation mode of the power switch is put in ON with the quick charge connector connected to the quick charge port, the Plug-in Hybrid EV System cannot be started.  
Be sure to disconnect the quick charge connector before starting the Plug-in Hybrid EV System.
- Charging will stop at approximately 80 % charge. This is a control for efficient charge and not a malfunction.  
To achieve full charge, repeat charging from Step 2 again.
- Make sure that the inner lid is completely closed before closing the charging lid.  
If the charging lid is forcibly closed without first completely closing inner lid, the hinge on the inner lid may be broken.
- When the operation mode of the power switch is put in ON while the charging lid is not completely closed, a warning may be displayed on the information screen in the multi-information display.  
Refer to "Warning display list" on page 5-162.
- On the vehicle equipped with the charging lid lock, if the charging lid is closed while the driver's door is locked, the charging lid will be locked.

**3**

## High-Voltage components

### High-Voltage components

N01205701066

3

#### ⚠ WARNING

- The Plug-in Hybrid EV System uses high voltage up to DC 300 volt. The system can be hot during and after starting and when the vehicle is shut off. Be careful of both the high voltage and the high temperature. Follow the warning labels that are attached to the vehicle.
- Never touch, disassemble, remove or replace high-voltage parts, exposed electrical components, cables or connectors. Failure to follow this instruction can result in severe burns or electric shock causing serious injury or death. High-voltage cables are colored orange. The vehicle high voltage system has no user serviceable parts. Take your vehicle to a certified Mitsubishi EV dealer for any necessary maintenance.
- Always assume the high voltage battery and associated components are energized and fully charged.

High voltage components and wiring cables are located as shown in the figure below.

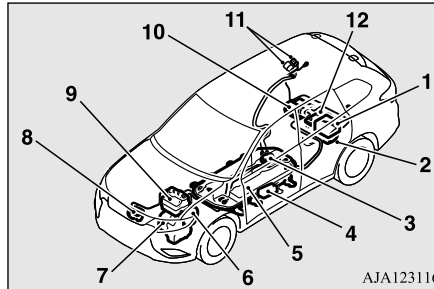

AJA123116

- 1- On board charger/DC-DC converter
- 2- Rear motor
- 3- Service plug
- 4- Electric heater
- 5- Main drive lithium-ion battery
- 6- Front motor
- 7- Generator
- 8- Air conditioner compressor
- 9- Power drive unit (PDU)
- 10- Rear electric motor control unit (MCU)
- 11- Normal charge port/Quick charge port (if so equipped)
- 12- 120 V AC power supply (if so equipped)

#### In case of a collision

N01205801041

A crash or impact significant enough to require an emergency response for conven-

tional vehicles would also require the same response for Plug-in Hybrid electric vehicle. Also follow the instructions described below to avoid severe burns and electrical shock that may result in serious injury or death.

#### ⚠ WARNING

- If your vehicle is drivable, pull your vehicle off the road to a safe, nearby location and remain on the scene. Also, if possible, do the following operations and stay out of the way of any oncoming traffic while awaiting the arrival of emergency responders.
  - Apply chocks to the wheels.
  - Put the select position in the “P” (PARK) position.
  - Apply the parking brake.
  - Open the windows, doors and liftgate.
  - Put the operation mode in OFF.
  - Turn on the hazard warning flashers.
  - Move the key away from the vehicle to prevent unintended start-up of the system by inadvertent contact with a switch or impact from the crash.
- Never touch high-voltage wiring, connectors, and other high-voltage parts, such as the inverter unit and main drive lithium-ion battery. An electric shock may occur if exposed electric wires are visible when viewed from inside or outside of your vehicle. For their locations, see “High-voltage components” on page 3-36.

## High-Voltage components

3

**⚠ WARNING**

- If the vehicle receives a strong impact to the floor while driving, stop the vehicle in a safe place and check the floor.
- Leaks or damage to the main drive lithium-ion battery may result in a fire. If you discover them, contact emergency services immediately. Since the fluid leak may be lithium manganite from the Lithium-ion battery, never touch any fluid leaking from the inside or outside of the vehicle. If the fluid contacts your skin or eyes, wash it off immediately with a large amount of water and receive immediate medical attention to help avoid serious injury.
- If you are unable to safely assess the vehicle due to vehicle damage, do not touch the vehicle. Leave the vehicle and contact emergency services. Advise emergency responders that this is Plug-in Hybrid electric vehicle.
- If a fire occurs in this vehicle, leave the vehicle as soon as possible and contact emergency services. Do not attempt to extinguish a fire by yourself. If the fire involves a lithium-ion battery, it will require large, sustained volumes of water for extinguishment. Using a small amount of water or the incorrect fire extinguisher can result in serious injury or death from electrical shock.

**⚠ WARNING**

- When you leave the vehicle, if possible, open the windows, doors and liftgate to prevent accumulation of poisonous/com-bustible gasses. This will also assist in the rescue and fire fighting process.
- As with any vehicle fire, the byproducts of combustion can be toxic. Do not inhale smoke, vapors, or gas from the vehicle. Move to a safe distance upwind and uphill from the vehicle fire and out of the way of any oncoming traffic while awaiting the arrival of emergency responders.
- If you detect leaking fluids, sparks, smoke, flames, gurgling, popping or hissing noises originating from the high voltage battery compartment, contact emergency services immediately. This may result in a fire.
- Physical damage to the vehicle or high voltage battery may result in immediate or delayed release of toxic and/or flammable gases and fire.
- If your vehicle needs to be towed, transport the vehicle on a flatbed truck or tow the vehicle either with all wheels off the ground. If the any wheels are on the ground when towing, this may cause damage to the electric motors. This may also cause a fire, if wiring in the electric motor unit room becomes damaged. Refer to "Towing" on page 8-17.

**⚠ WARNING**

- Do not attempt to repair a damaged Plug-in Hybrid electric vehicle yourself. Please contact a certified Mitsubishi EV dealer for service.
- In the event of an accident that requires body repair and painting, the vehicle should be delivered to a certified Mitsubishi EV dealer to have the main drive lithium-ion battery and high voltage parts such as the inverter, including the attached wiring harness, removed prior to painting. If exposed to heat in the paint booth, the main drive lithium-ion battery will experience battery capacity loss. A damaged main drive lithium-ion battery can also pose safety risks to untrained mechanics and repair personnel.

**📖 NOTE**

- The emergency shut-off system will be activated and the high-voltage system will automatically turn off under the following conditions:
  - Certain front, side or rear collisions.
  - Certain Plug-in Hybrid EV System malfunctions.
- When the emergency shut-off system is activated, the ready indicator is turned off. Refer to "Indicator light, warning light, and information screen display list" on page 5-160.
- If the emergency shut-off system activates, contact a certified Mitsubishi EV dealer.

## MITSUBISHI Remote Control (if so equipped)

### MITSUBISHI Remote Control (if so equipped)

N01216300052

3

The MITSUBISHI Remote Control allows you to operate the vehicle within the communication range of the wireless LAN device (which conforms to IEEE 802.11b and supports iOS or Android). The following operations are available.

#### NOTE

- The communication distance differs depending on the wireless LAN device, due to this the communication may go down.

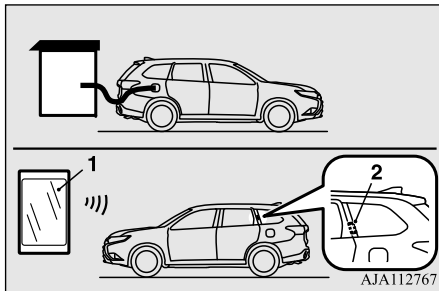

- 1- Wireless LAN device
- 2- Antenna

#### • Charging timer

If you specify the charge start and/or stop time with the normal charge cable connected, charging is started and/or stopped at that time.

#### • Remote climate control

By setting the remote climate control to operate at a predetermined time, cabin comfort can be improved or visibility can be ensured (defrosting/demisting) before getting in the vehicle.

#### • Customize (function setting change)

The function setting of the F.A.S.T.-key, outside rear-view mirror, operation mode of the power switch, air conditioning, lights and windshield wipers can be changed by MITSUBISHI Remote Control.

#### NOTE

- In a vehicle equipped with the Smartphone-link Display Audio (SDA), it is possible to change the setting by means of screen operations. Refer to the separate owner's manual for details.

#### NOTE

- If you want to quickly start normal charging even when the charging timer is already set, you can cancel the charging timer and start the normal charging by the following methods.

[How to temporarily cancel the charging timer]

You can temporarily cancel the charging timer by the following methods.

In addition, the predetermined charging timer settings automatically return after the charging timer is turned on again or the operation mode of the power switch is put in ON.

#### • F.A.S.T.-key

After connecting the normal charging cable and closing all doors and the liftgate, you can cancel the charging timer by pressing the switch (A) of the F.A.S.T.-key twice within 2 seconds.

When the charging timer is canceled, the hazard warning lights will blink four times.

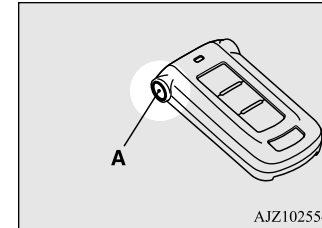

- Wireless LAN device

### MITSUBISHI Remote Control (if so equipped)

**NOTE**

[How to cancel the charging timer]  
The charging timer can be canceled by the following methods.

- Wireless LAN device
- Smartphone-link Display Audio (SDA)

● When using the charging timer, use the EV charging cable.  
If using a home or public charging device (EVSE: Electric Vehicles Supply Equipment), the charging timer may not be started.

Devices that support wireless LAN are required to communicate with the vehicle using the MITSUBISHI Remote Control. Also, an SSID\* (A) and password (B) are required to connect a wireless LAN device to the vehicle. The SSID and password are described in the registration information card (C) that is attached to the key at the time of your purchase of the vehicle.

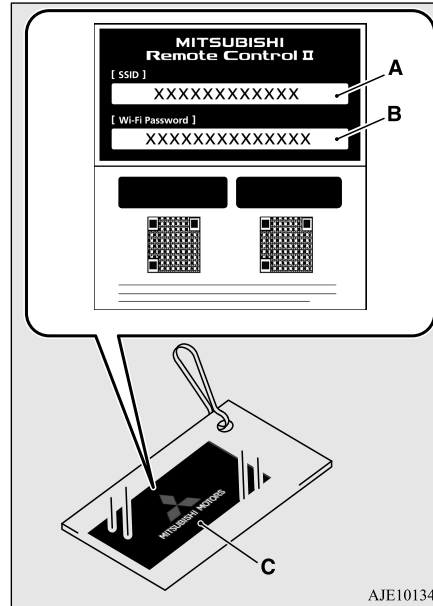

\*: An SSID is the identifier of an access point for IEEE 802.11 series wireless LAN. It is displayed on wireless LAN devices.

**NOTE**

- When you transfer ownership of the vehicle to another person, transfer the registration information card with the vehicle.

For the function and the operation method of the MITSUBISHI Remote Control, please visit Mitsubishi Motors' Web site (in English only):



[https://www.mitsubishi-motors.com/en/products/outlander\\_phev2/app/remote/](https://www.mitsubishi-motors.com/en/products/outlander_phev2/app/remote/)

- If you need further information, please contact a certified Mitsubishi EV dealer.

**WARNING**

- The Remote Climate Control, even when set, cannot be relied upon to maintain safe vehicle cabin temperatures while the vehicle is stopped or parked. Never leave children or persons requiring supervision/nursing unattended inside the vehicle. Temperature inside the vehicle could become extremely high or low resulting in a risk of heat stroke or hyperthermia that could result in death. In addition, children can activate switches and controls, resulting in an injury or fatal accident.

3

## MITSUBISHI Remote Control (if so equipped)

3

### ⚠ WARNING

- The cooling fan in the engine compartment can automatically start during charging or while the air conditioner is operating. Keep away from the cooling fan under the hood.

### ⚠ CAUTION

- Do not use a car cover except for the Mitsubishi Motors Genuine car cover, when using the charging timer or the remote climate control.

### 📖 NOTE

- When ownership of the vehicle is transferred to or from others, it is necessary to initialize the registration of MITSUBISHI Remote Control.  
For the registration initialization procedure, please visit our web site.  
[https://www.mitsubishi-motors.com/en/products/outlander\\_phev2/app/remote/](https://www.mitsubishi-motors.com/en/products/outlander_phev2/app/remote/)
- Keep the following points in mind when using a wireless LAN device:
  - Communication speed and range vary depending on the wireless LAN devices and the surrounding conditions (radio environment, obstacles, parking area environment, etc.).

### 📖 NOTE

- Due to the characteristics of radio waves, communication speed tends to decrease as the communication distance increases. Use your wireless LAN device at a short distance from the vehicle for better response.
- When a microwave oven or ISM (industrial, scientific and medical) equipment is being used, the communication speed and range of wireless LAN devices may decrease. Use your wireless LAN device away from these appliances and equipment.
- If a wireless LAN device and Bluetooth® (registered trademark of Bluetooth SIG, Inc.) are used simultaneously, the communication speed and range of each device may decrease. Use your wireless LAN device away from Bluetooth® devices.
- Wireless LAN devices may not communicate with the vehicle, or may not operate normally or stably in the following environment or situations. Check that the device can communicate with your vehicle before use.
  - There is an obstruction such as a concrete or metal wall between the vehicle and wireless LAN device.
  - The vehicle is surrounded by tall vehicles in a parking lot.
  - There are facilities nearby that emit strong radio waves, such as a TV tower, transformer substation, broadcasting station or airport.

### 📖 NOTE

- There is a communication device such as a mobile phone or radio, or an electric device such as a personal computer near the wireless LAN device.
- The wireless LAN device is in contact with or covered by a metal object.
- The battery of the wireless LAN device has run down.
- The MITSUBISHI Remote Control cannot be used under the following conditions:
  - The wireless LAN device is turned off.
  - The MITSUBISHI Remote Control application software is not installed.
  - The MITSUBISHI Remote Control application software is not running.
  - The wireless LAN device is not registered on the vehicle or it is not connected to the vehicle.
  - The wireless LAN device is out of the communication range.
  - The wireless LAN device is connected to other wireless LAN device.
  - The wireless LAN device has failed, or its battery has run out.
- Some charging facilities have a timer function that turns the power on or off at a specific time of the day. When charging at a facility with a timer function, make sure that the charging timer is set within the time period when the power in the charging facility is on.



## MITSUBISHI Remote Control (if so equipped)

3

### NOTE

- The 12 V starter battery is automatically and periodically charged using electrical power stored in the main drive lithium-ion battery. A buzzer in cabin sounds while the 12 V starter battery is being charged.
- While the remote climate control is operating or the charging, the cooling fan or air conditioner compressor may start operating and its sound may be heard. But this is normal.
- The remote climate control operates in its own mode based on the mode selected on the wireless LAN device, regardless of the switch setting of the vehicle's air conditioner.
- Air conditioning performance may deteriorate or the remaining quantity of the main drive lithium-ion battery may decrease under the following conditions:
  - In extremely hot weather.
  - In hot sunshine.
  - In extremely cold weather.
- If the remote climate control is started during charging, the time until full charge may extend or the charging rate may decrease.
- When the remaining quantity of the main drive lithium-ion battery is decreased, the remote climate control does not operate or it may stop on the way.

### NOTE

- When the 12 V starter battery is removed, the timer control of the MITSUBISHI Remote Control is reset and each function of the MITSUBISHI Remote Control cannot be used. Also the main drive lithium-ion battery cannot be warmed up. Communicate the wireless LAN device and your vehicle again.

### General information

N01216600039

MODEL: K9499-002  
 FCC ID: RX8K9499-001  
 IC: 2795E-K9499001

This device complies with Part 15 of FCC Rules and Industry Canada licence-exempt RSS standard(s). Operation is subject to the following two conditions:

- (1) this device may not cause interference, and
- (2) this device must accept any interference, including interference that may cause undesired operation of this device.

### CAUTION

- Changes or modifications not expressly approved by the party responsible for compliance could void the user's authority to operate the equipment.

This equipment complies with FCC/IC radiation exposure limits set forth for an uncontrolled environment and meets the FCC radio frequency (RF) Exposure Guidelines in Supplement C to OET65 and RSS-102 of the IC radio frequency (RF) Exposure rules. This equipment has very low levels of RF energy that it deemed to comply without maximum permissive exposure evaluation (MPE). But it is desirable that it should be installed and operated keeping the radiator at least 20 cm or more away from person's body (excluding extremities: hands, wrists, feet and ankles).

### Para los vehículos vendidos en México

La operación de este equipo está sujeta a las siguientes dos condiciones: (1) es posible que este equipo o dispositivo no cause interferencia perjudicial y (2) este equipo o dispositivo debe aceptar cualquier interferencia, incluyendo la que pueda causar su operación no deseada.

IFETEL: RCPKOK918-1609



## How to use electric device during charging

### How to use electric device during charging

N01216700030

3

If the operation mode of the power switch is put in ON during normal charging, quick charging, V2H charging, V2H power supply, you can use air conditioning, car navigation system, audio equipment and so on.

#### V2H (Vehicle to Home)

Vehicle power can be used as a household power supply source. Bidirectional charging of the vehicle or the home is carried out by using the quick charge connector of CHAdeMO standard which is same as quick charge. "V2H charging" will charge the vehicle from the V2H main unit. "V2H power supply" supplies power from the vehicle to the home via the V2H main unit.

For details of V2H, please confirm with the instruction manual issued by the V2H maker or consult the V2H maker.

#### WARNING

● Any person with an electro-medical apparatus, such as implantable cardiac pacemaker or implantable cardioverter-defibrillator, should not be inside the vehicle when air conditioning is in operation during charging.

This may affect the operation of electro-medical apparatus.

● Do not leave children and people who need nursing care and pets etc. inside the vehicle.

The inside of the vehicle may become hot or cold for reasons such as automatic system shutdown.

Also, when the outside air temperature is low, the temperature inside the vehicle may fall rapidly. In the worst case, there is a danger of death.

Also, since the wiper and the electric parking brake can be operated, an error in operation may lead to unexpected accidents.

● Please check the surroundings before using.

● Do not move the selector lever, the vehicle may move unintentionally.

#### NOTE

● When using electric devices during charging, the charging of the main drive lithium-ion battery is restricted and the following cases occur.

#### NOTE

● During normal charging:

The electricity consumption becomes larger than the charge amount, the main drive lithium-ion battery may not be charged, and the remaining power of the main drive lithium-ion battery may decrease.

● During quick charging:

Charging time may become longer. Also, depending on the specifications of the quick charger, the main drive lithium-ion battery may not be charged and the remaining power of the main drive lithium-ion battery may decrease.

● If you use air conditioning etc. during charging, you may not be able to hear the radio due to strong electromagnetic waves or noise.

#### When using electrical devices

N01216800031

1. Start the normal charging or the quick charging.  
Refer to "Normal charging" on page 3-31.  
Refer to "Quick charging" on page 3-32.
2. Make sure that the charging indicator on the instrument cluster is illuminated.

#### NOTE

● If the charging indicator is not illuminated, the electrical devices will not be operated.  
Check that the charging is done correctly.

3. Put the operation mode of the power switch from OFF to ON.  
Refer to “Changing the operation mode” on page 5-11.

#### NOTE

- Always put the operation mode of the power switch in ON after the charging indicator is illuminated. Charging may not start when put the operation mode of the power switch in ON before the charging indicator is illuminated.
- When the operation mode of the power switch is ON, the doors and tailgate cannot be locked by the keyless entry or the F.A.S.T.-key function. When leaving the vehicle, put the operation mode in OFF and lock the vehicle.

4. Electric devices such as air conditioning, navigation system, audio equipment can be used.  
Refer to “Warning display list” on page 5-162.

#### NOTE

- Put the operation mode in ON and use the electrical devices. If the operation mode of the power switch is ACC, air conditioning cannot be used.
- 120 V AC Power Supply (1500 W) cannot be used during charging.

#### NOTE

- If the information screen of the multi-information display is switched to the energy flow display, you can see the state of charging and discharging of the main drive lithium-ion battery.  
Refer to “Energy flow indication during charging” on page 3-44.

### When stopping the use of electrical devices

N01216900032

Put the operation mode of the power switch in OFF. Electric devices such as air conditioning, audio equipment etc. can be stopped. Refer to “Changing the operation mode” on page 5-11.

#### NOTE

- Charging continues even if the operation mode of the power switch is put in OFF.

### Automatic OFF of the operation mode

N01217000030

In the following cases, the operation mode will be put in OFF automatically.

### How to use electric device during charging

- When the remaining power of the main drive lithium-ion battery further decreases after air conditioning is stopped.
- When the outside air temperature is low and the following warning display appears.

**3**

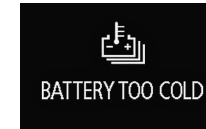

- When charging is completed.
- When the normal charge connector is disconnected.
- When the charging stop operation is performed by the quick charger.
- When quick charging time has passed 60 minutes.
- When the stop condition (charging amount/charging time) on the quick charger is satisfied.
- When charging stops due to the electrical power outage.
- When charging stops due to a failure.
- When operating the selector lever to “N” (NEUTRAL) position. (charging also stops)

## How to use electric device during charging

3

### NOTE

- Even when the operation mode automatically put in OFF, air conditioning, car navigation system, audio equipment, etc. will stop. Also, the vehicle status will be the same as putting the operation mode in OFF manually, such as the headlights go off, the dome lights are illuminated or the outside rearview mirrors are retracted automatically (if so equipped), etc..

### Automatic stop of the air conditioner

N01217100031

In the following cases, air conditioning automatically stops. When air conditioning stops, air conditioning control panel turns off.

- When the remaining power of the main drive lithium-ion battery becomes low and the following warning display appears.



Refer to “Warning display list” on page 5-162.

- When the temperature of the main drive lithium-ion battery becomes extremely low and the following warning display appears.



Refer to “Warning display list” on page 5-162.

### NOTE

- To use air conditioning again after air conditioning automatically stops, press the power switch while the following message is displayed to put the operation mode of the power switch in OFF, then press the power switch again to put the operation mode in ON.

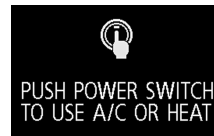

Refer to “Warning display list” on page 5-162.

### Energy flow display during charging

N01217200029

It shows the flow of energy during charging.

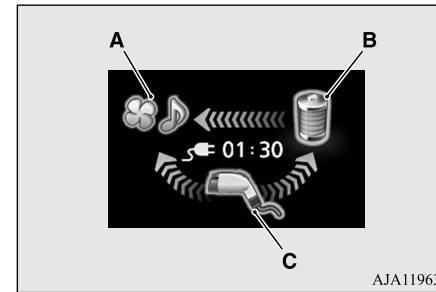

AJA119636

- A: Various electrical devices
- B: Main drive lithium-ion battery
- C: Charger

Blue arrow: Flow of electric energy

### Display of energy flow (example)

#### When charging the drive battery

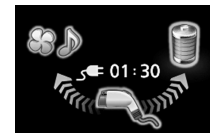

## How to use electric device during charging

### When discharging from the main drive lithium-ion battery



### NOTE

- Energy flow display may change regardless of the operation of air conditioning, car navigation system, audio equipment, etc.
- If you change the settings of air conditioning, it may take time until the display of energy flow stabilizes.

3

### When the V2H power supply



### When no energy flow



### NOTE

- Even when you are not operating air conditioning, car navigation system, audio equipment, etc., since the on-board computer consumes electricity, arrows may be displayed from the charger or the main drive lithium-ion battery.

## Charging troubleshooting guide

## Charging troubleshooting guide

N01202301061

3

Symptom	Possible cause	Possible solution
Charging cannot be started.	The operation mode of the power switch is in ON.	Before charging, put the operation mode of the power switch in OFF.
	The main drive lithium-ion battery is already fully charged.	Charging cannot be performed if the main drive lithium-ion battery is already fully charged. Charging automatically turns off if the main drive lithium-ion battery is fully charged.
	The temperature of the main drive lithium-ion battery is too high or too low to charge.	Confirm the main drive lithium-ion battery temperature. Refer to “Cautions and actions to deal with intense heat” on page 3-12 and “Cautions and actions to deal with intense cold” on page 3-13.
	The 12 V starter battery is discharged.	The main drive lithium-ion battery can be charged if the vehicle electrical systems cannot be turned on. If the battery is discharged, charge or jump start the 12 V starter battery. Refer to “Jump-starting the Plug-in Hybrid EV system” on page 8-2.
	The vehicle or the EV charging cable has a malfunction.	The vehicle or the EV charging cable may have a malfunction. Confirm if the warning light on the meter is illuminated. Confirm if the indicator on the charger is indicating a malfunction. If a warning is displayed, stop charging and contact a certified Mitsubishi EV dealer.
	The fuse has blown.	Confirm if the fuse of the interior lights (dome lights) in the fuse block in the passenger compartment located in front of the driver’s seat has blown. Refer to “Fuses” on page 9-24.

## Charging troubleshooting guide

Symptom	Possible cause	Possible solution
Normal charging cannot be started.	There is no electrical power coming from the outlet.	Confirm that there has not been a power failure. Make sure the breaker is on. If an outlet with a timer device installed is used, power will only be available at the time set by the timer. Confirm if the POWER indicator on the control box is illuminated.
	The charge connector is not connected correctly.	Confirm the charge connector is connected correctly.
	The charge connector was connected and disconnected repeatedly in a short time.	Disconnect the charge connector, wait for a while, then start charging procedure again from the beginning.
	A charging cable for other vehicle is used.	Use the EV charging cable only for your vehicle.
	The normal charger may not be compatible with your vehicle.	Ask an administrator or the manufacturer of the normal charger whether the charger is compatible with your vehicle. Always follow the instructions shown on the normal charger.
	Reservation of charging timer is set up by MITSUBISHI Remote Control (if so equipped) or the Smartphone-link Display Audio (SDA).	The normal charging cannot be started when the EV charging cable is connected, if the charging timer is set. Cancel all the charging timer settings, if you want to start the normal charging immediately. Refer to "MITSUBISHI Remote Control" on page 3-38. For the Smartphone-link Display Audio (SDA), refer to the separate owner's manual.

3

## Charging troubleshooting guide

3

Symptom	Possible cause	Possible solution
Normal charging is discontinued.	There is no power coming from the outlet.	There may have been an electrical power failure, or the breaker may have failed. Charging will resume when the power source is reset.
	The EV charging cable has been disconnected.	Check that the EV charging cable has not been disconnected.
	The button on the normal charge connector has been pressed.	If the normal charge connector button is pressed for a long period of time, charging will be stopped. Start the charging procedure again.
	The temperature of the main drive lithium-ion battery is too hot or too cold to charge.	Confirm the main drive lithium-ion battery temperature. Refer to “Cautions and actions to deal with intense heat” on page 3-12 and “Cautions and actions to deal with intense cold” on page 3-13.
	Charging is stopped by the normal charge timer.	Charging will stop depending on the timer function setting of the normal charge device. If you need to charge the main drive lithium-ion battery more, start the charging procedure again.
	The Charging timer was set up by the MITSUBISHI Remote Control (if so equipped) or the Smartphone-link Display Audio (SDA) after starting of normal charging.	Cancel all the charging timer settings. Charging is automatically restarted if you cancel the charging timer. Refer to “MITSUBISHI Remote Control” on page 3-38. For the Smartphone-link Display Audio (SDA), refer to the separate owner’s manual.
Quick charging cannot be started.	The charge connector is not connected correctly and/or not locked.	Check that the charge connector is connected correctly and that it is locked.
	The self-diagnostic function of the quick charge device returns a negative result.	There is a possibility that the vehicle has a malfunction. Stop charging and contact a certified Mitsubishi EV dealer.
	The power switch of the quick charger is off.	Check the power switch of the quick charger. Consult an administrator or a maker of the quick charger.



Fuel selection

3

Symptom	Possible cause	Possible solution
Quick charge is discontinued.	Charging is stopped by the quick charge timer.	Charging will stop depending on the timer function setting of the quick charge device. If you need to charge the main drive lithium-ion battery more, start the charging procedure again.
	Charging stops at 80 % capacity.	Charging is designed to stop when the main drive lithium-ion battery capacity reaches 80 %. If you need to charge the main drive lithium-ion battery more than 80 %, start the charging procedure again.
	The power supply for the quick charger is off.	Check whether the power supply for the quick charger is off. Consult an administrator or a maker of the quick charger.
The charging indicator is continuously blinking even if the quick charge connector is not connected into the quick charge port when you start the Plug-in Hybrid EV system after quick charging.	Quick charging has not finished normally.	Perform quick charging again and finish it normally or contact a certified Mitsubishi EV dealer.
Plug-in Hybrid EV System does not start after quick charging.	The vehicle have a malfunction.	Contact a certified Mitsubishi EV dealer. If you need to push the vehicle, put the operation mode of the power switch in ON and put the select position in the “N” (NEUTRAL) position.

**Fuel selection**

N01207600033

Your vehicle is designed to use unleaded gasoline only. It is equipped with a fuel tank filler pipe specifically designed to accept only a small diameter unleaded gasoline dispensing nozzle.

**⚠ WARNING**

● Gasoline is highly flammable and explosive. You could be burned, seriously injured or killed when handling it. Whenever you refuel your vehicle, put the operation mode of the power switch in OFF and keep flames, sparks, and smoking materials away from the vehicle. Always handle fuel in well-ventilated outdoor areas.

**⚠ CAUTION**

● Using leaded gasoline in your vehicle will damage the engine, catalytic converter, and the oxygen sensors. Also, using leaded gasoline is illegal, and will void your warranty coverage of the engine, catalytic converter, and oxygen sensors.

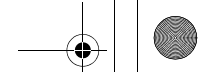

## Fuel selection

### Gasoline detergent additives

**3**

In the United States, fuel suppliers are required by law to add detergents to their gasoline to minimize fuel-injector clogging and minimize intake-valve deposits. Detergent gasoline helps keep your engine in tune and your emission-control system working properly.

### Octane requirement

Your vehicle is designed to operate on unleaded gasoline having a minimum octane number of 87 [(MON+RON)/2] or 91 RON.

### Oxygenated gasoline

Gasoline sold at some service stations contains oxygenates such as ethanol, although the oxygenates may not be identified by those names. Oxygenates are required in some areas of the country. Oxygenated fuel can be used in your vehicle.

### Ethanol (Gasohol)

A mixture of up to 10 % ethanol (grain alcohol) and 90 % unleaded gasoline may be used

in your vehicle, provided the octane number is at least as high as that recommended for unleaded gasoline.

### Methanol

Do not operate your vehicle on gasoline containing methanol (wood alcohol). Using this type of alcohol could adversely affect the vehicle's performance and damage critical parts of the vehicle's fuel system.

### Reformulated gasoline

Many areas of the country require the use of cleaner burning fuel referred to as "Reformulated Gasoline".

Reformulated gasoline contains oxygenates and is specially blended to reduce vehicle emissions and improve air quality.

Mitsubishi Motors Corporation strongly supports the use of reformulated gasoline. Properly blended reformulated gasoline has no adverse effect on vehicle performance or the durability of the engine and the fuel system.

### MMT (methylcyclopentadienyl manganese tricarbonyl)

MMT is a manganese-containing metallic additive that is blended into some gasolines to increase the octane number. Mitsubishi Motors Corporation recommends using gasolines without MMT.

Use of gasolines blended with MMT may adversely affect performance, and cause the malfunction indicator on your instrument panel to come on. If this happens, contact a certified Mitsubishi EV dealer for assistance.

### Sulfur in gasoline

Your vehicle may have been designed to satisfy California's low-emission regulations based on clean-burning low-sulfur gasoline. Gasoline sold in parts of the country other than California is allowed to have a higher sulfur content. Using such gasoline could adversely affect the vehicle's catalytic converter and cause the engine malfunction indicator ("SERVICE ENGINE SOON" or "Check engine light") to come on. Illumination of this indicator while using high-sulfur gasoline does not necessarily mean the vehicle's emission-control system is malfunctioning. A certified Mitsubishi EV dealer may suggest using a different, lower-sulfur brand

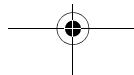

of unleaded gasoline to determine if the problem is fuel-related.

### NOTE

- Poor-quality gasoline can cause problems such as hard starting, stalling during idling, abnormal engine noise, and poor acceleration. If you experience any of these problems, try using a different brand of gasoline. If the engine malfunction indicator (“SERVICE ENGINE SOON” or “Check engine light”) flashes, have the vehicle inspected as soon as possible by the nearest a certified Mitsubishi EV dealer.

## Filling the fuel tank

N01207700050

### WARNING

- When handling fuel, comply with the safety regulations displayed by garages and filling stations.
- Gasoline is highly flammable and explosive. You could be burned, seriously injured or killed when handling it. When refueling your vehicle, always turn off the Plug-in Hybrid EV system and keep away from flames, sparks, and smoking materials. Always handle fuel in well-ventilated outdoor areas.

### WARNING

- Before removing the fuel tank filler cap, be sure to get rid of your body’s static electricity by touching a metal part of the car or fuel pump. Any static electricity on your body could create a spark that ignites fuel vapor.
- Perform the whole refueling process (opening the fuel tank filler door, removing the fuel cap, etc.) by yourself; do not let any other person near the fuel tank filler. If you allowed a person to help you and that person was carrying static electricity, fuel vapor could be ignited.
- Never perform charging and refueling simultaneously. During charging, you could pick up a fresh charge of static electricity. Any static electricity on your body could create a spark that ignites fuel vapor.
- Do not move away from the fuel tank filler until refueling is finished. If you moved away and did something else (for example, sitting on a seat) part-way through the refueling process, you could pick up a fresh charge of static electricity.
- Be careful not to inhale fuel vapor. Fuel contains toxic substances.
- Keep the doors and windows closed while refueling the vehicle. If they were open, fuel vapor could get into the cabin.

## Filling the fuel tank

### Fuel tank capacity

11.3 gal (43 L)

### Refueling

1. Before refueling, put the operation mode of the power switch in OFF to stop the Plug-in Hybrid EV system.
2. The fuel tank filler is located on the rear driver side of your vehicle. The fuel tank filler door can be opened from inside the vehicle by pressing the fuel tank filler door switch located on the instrument panel.

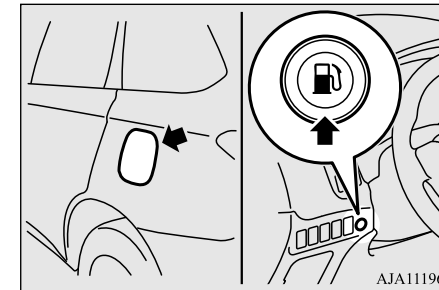

3

### Filling the fuel tank

3

3. The internal pressure of the fuel tank will automatically be released to prevent fuel overflowing from the fuel filler.

Before opening the fuel tank filler cap, wait until “READY TO REFUEL” is displayed on the information screen in the multi-information display. If the internal pressure is high, it may take several seconds.

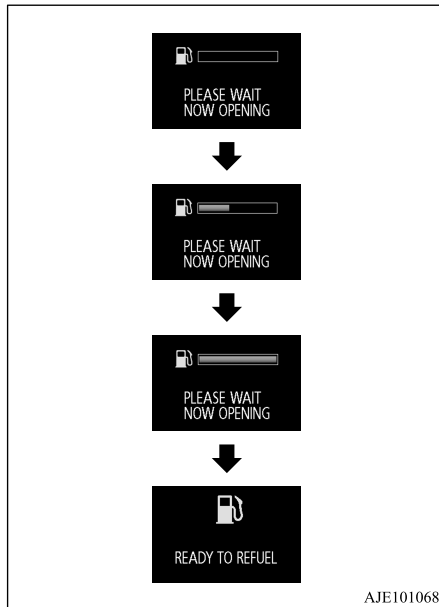

#### WARNING

- If a problem occurs related to the system for releasing the internal pressure of the fuel tank, a warning will be displayed on the information screen in the multi-information display and the fuel tank filler door cannot be opened. Have your vehicle inspected by a certified Mitsubishi EV dealer as soon as possible.



#### NOTE

- If the 12 V starter battery is weak or discharged, the function to release the internal pressure of the fuel tank is disabled and the fuel tank filler door cannot be opened.

4. Open the fuel tank filler pipe by slowly turning the fuel tank filler cap counter-clockwise.

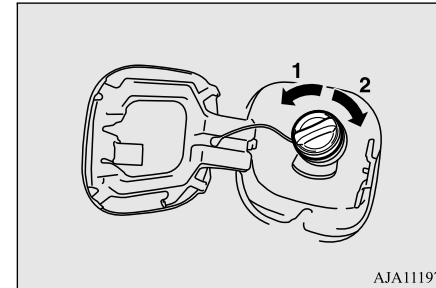

- 1- Remove
- 2- Close

#### WARNING

- Since the fuel system may be under pressure, remove the fuel tank filler cap slowly. This relieves any pressure or vacuum that might have built up in the fuel tank. If the cap is venting vapor or if you hear a hissing sound, wait until the sound stops before removing the cap. Otherwise, fuel may spray out, injuring you or others.

## Filling the fuel tank

3

### NOTE

- While filling with fuel, hang the fuel cap on the hook (A) located on the inside surface of the fuel tank filler door.

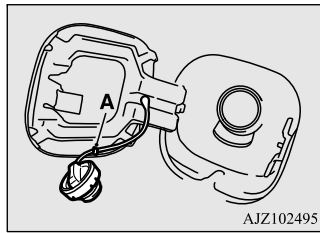

5. Fueling correctly depends mainly on correct handling of the fuel filler nozzle. Do not tilt the nozzle. Insert the nozzle in the fuel tank filler port as far as it goes.

### CAUTION

- Never press the pin (B) during refueling. Doing so can cause the fuel to overflow from the fuel filler.

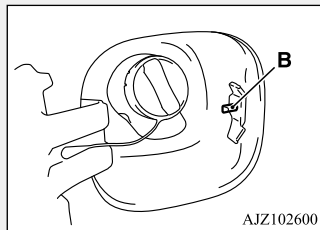

### CAUTION

- Your vehicle can only be operated using unleaded gasoline. Serious engine and catalytic converter damage will result if leaded gasoline is filled into these vehicles, and consequently, this must never be attempted.

6. When the nozzle stops automatically, do not add more fuel.

### CAUTION

- To avoid fuel spillage and overfilling, do not “top-off” the fuel tank. Spilled fuel could discolor, stain, or crack the vehicle’s paintwork. If fuel spills on the paintwork, wipe it off with a soft cloth.
- Refueling should be completed within 30 minutes after pressing the fuel tank filler door switch. After 30 minutes, the refueling system for releasing the internal pressure of the fuel tank will be disabled. Close the fuel cap and fuel tank filler door once. To prevent the fuel from overflowing, press the fuel tank filler door switch again to reactivate the refueling system.

7. To re-install, turn the fuel tank filler pipe cap slowly clockwise until you hear clicking sounds, then gently push the fuel tank filler door closed.

### WARNING

- Make sure the fuel tank filler cap is securely closed. If the fuel cap were loose, fuel could leak, resulting in a fire.

### CAUTION

- If you need to replace the fuel tank filler cap, use only the cap specified for your model vehicle.

### NOTE

- If the fuel tank filler cap is not tight while driving, the engine malfunction indicator (“SERVICE ENGINE SOON” or “Check engine light”) may come on when the onboard diagnostic (OBD) system performs a self check. Always tighten the fuel tank filler cap until you hear at least three clicks. The indicator will go off after several driving cycles. If the indicator does not go off, contact a certified Mitsubishi EV dealer as soon as possible.

## Modifications to and racing of your vehicle

3

### NOTE

- If you drive with the fuel tank filler door left open, warning display is displayed on the information screen in the multi-information display.



### If the fuel tank filler door cannot be opened

N01207900049

To open the fuel tank filler door, the manual fuel tank filler door release lever inside of the interior trim cover (A) can be used.

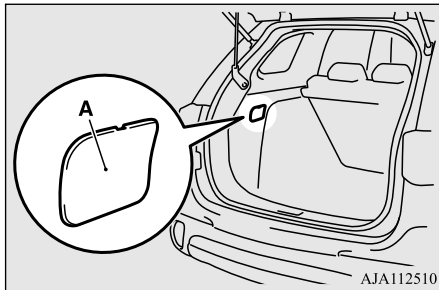

AJA112510

### WARNING

- Never use the manual fuel tank filler door release lever unless the fuel door cannot be opened by operating the fuel tank filler door switch.

If the fuel tank filler door is opened using the manual fuel tank filler door release lever, the internal pressure of the fuel tank will not automatically be released. To avoid the fuel overflowing from the fuel filler, remove the fuel tank filler cap slowly to gradually release the internal pressure of the fuel tank and refuel with a lower flow rate.

### To open the fuel tank filler door manually

1. Open the cover (A) and then pull the lever (B) to open the fuel tank filler door.

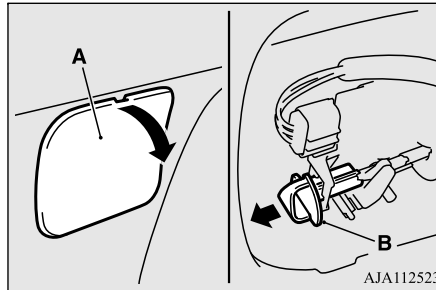

AJA112523

### CAUTION

- If the cover (A) is left open, luggage can accidentally contact the manual fuel tank filler door release lever and the fuel tank filler door can open.

### NOTE

- When the manual fuel tank filler door release lever is operated, the warning screen shown in the illustration may be displayed.



The warning screen will disappear when;

- Several seconds after the vehicle is driven with closing the fuel tank filler door; or
- Approximately 30 minutes after the manual fuel tank filler door release lever is operated.

### Modifications to and racing of your vehicle

N01200501030

This vehicle should not be modified with non-Mitsubishi Motors genuine parts. Mitsubishi Motors designs and manufactures high quality vehicles with an emphasis on safety and durability. Modifications using

non-Mitsubishi Motors genuine parts may affect the performance, safety and/or durability of your vehicle, and may violate applicable state and/or federal regulations.

**DAMAGE OR PERFORMANCE PROBLEMS RESULTING FROM MODIFICATIONS TO OR RACING OF YOUR VEHICLE ARE NOT COVERED UNDER WARRANTY.**

Examples of modifications to your vehicle that can cause damage or performance problems include the following:

- Failure to use Mitsubishi Motors genuine parts
- Failure to use required fuel and fluids
- Failure to use proper size tires and wheels
- Modification of the fuel, intake, exhaust, emission, suspension, electric motor, engine, drive train, batteries (main drive lithium-ion battery and 12 V starter battery), charging systems or electrical wiring systems
- Modification of any onboard computer/control module, including reprogramming, or replacing/adding chips to any onboard computer/control module

Review the Warranty and Maintenance Manual for further details regarding warranty coverage.

**Installation of accessories**

N01200601057

**CAUTION**

- Before any electrical or electronic accessories are installed, consult a certified Mitsubishi EV dealer.
- Your vehicle is equipped with a diagnosis connector (data link connector) for checking and servicing the electronic control system. Mitsubishi Motors does not recommend connecting a device other than the Scan Tool for inspections and service to this connector because an unexpected problem could result. In addition, malfunctions caused by connecting a device other than the Scan Tool may not be covered under warranty.

- The installation of accessories, optional parts, etc., should only be performed within the limits prescribed by law, and in accordance with the guidelines and warnings contained within the documents accompanying this vehicle. Only Mitsubishi Motors approved accessories should be fitted to your vehicle.
- Improper installation of electrical parts could cause a fire. Refer to the “Modification/alterations to the electrical or fuel systems” section within this owner’s manual.

**Modifications to and racing of your vehicle**

- Using a cellular phone or radio set inside the vehicle without an external antenna may cause electrical system interference, which could lead to unsafe vehicle operation.
- Tires and wheels which do not meet specifications must not be used. Refer to the “Specifications” section for information regarding wheel and tire sizes.

**3**

**WARNING**

- **While driving, do not use a cellular phone in a way that hinders safe driving. Anything, including cellular phone usage, that distracts you from the safe operation of your vehicle increases your risk of an accident.**  
Refer to and follow all state and local laws in your area regarding cellular phone usage while driving.

**Important point!**

Due to the large number of accessory and replacement parts provided by different manufacturers in the market, it is not always possible for a certified Mitsubishi EV dealer to check whether the attachment or installation of non-Mitsubishi Motors genuine parts affects the driving safety of your vehicle.

## Genuine Mitsubishi Motors parts

### Modification/alterations to the electrical or fuel systems

N01200701032

3

Mitsubishi Motors manufactures high quality vehicles with an emphasis on safety. It is important to consult a certified Mitsubishi EV dealer before installation of any accessory which may involve modification of the electrical or fuel systems.

#### CAUTION

- Please consult a certified Mitsubishi EV dealer concerning any such accessory fitment or modification. If the wires interfere with the vehicle body or improper installation methods are used (protective fuses not included, etc.), electronic devices may be adversely affected, resulting in a fire, vehicle damage, or other accident.

### Genuine Mitsubishi Motors parts

N01207800022

Mitsubishi Motors Genuine Parts are designed and manufactured to meet high standards of performance, and are recommended for all of your maintenance needs. Also available from a certified Mitsubishi EV dealer are a wide variety of accessories to personalize your new vehicle. Each Mitsubishi Motors

3-56 General information/Charging

vehicle has a selection of Mitsubishi Motors authorized accessories to choose from to tailor your new vehicle to your own personal preference. A certified Mitsubishi EV dealer's Parts Manager has information on various audio systems, protection items, as well as interior and exterior accessories available for your specific model.

### California Perchlorate Materials Requirements

N01200900011

Certain components of this vehicle, such as airbag modules, seat belt pretensioners, and button cell batteries, may contain perchlorate materials.

Special handling may apply. For additional information, see [www.dtsc.ca.gov/hazardous-waste/perchlorate](http://www.dtsc.ca.gov/hazardous-waste/perchlorate).

### Event Data Recording

N01210000028

This vehicle is equipped with an event data recorder (EDR).

The main purpose of an EDR is to record, in certain crash or near crash-like situations, such as an airbag deployment or hitting a road obstacle, data that will assist in understanding how a vehicle's systems performed.

The EDR is designed to record data related to vehicle dynamics and safety systems for a short period of time, typically 30 seconds or less.

The EDR in this vehicle is designed to record such data as:

- How various systems in your vehicle were operating;
- Whether or not the driver and front passenger safety belts were buckled/fastened;
- How far (if at all) the driver was depressing the accelerator and/or brake pedal; and,
- How fast the vehicle was traveling.

These data can help provide a better understanding of the circumstances in which crashes and injuries occur.

#### NOTE

- EDR data are recorded by your vehicle only if a non-trivial crash situation occurs; no data are recorded by the EDR under normal driving conditions and no personal data (e.g., name, gender, age, and crash location) are recorded. However, other parties, such as law enforcement, could combine the EDR data with the type of personally identifying data routinely acquired during a crash investigation.



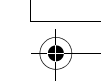
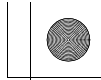
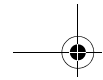
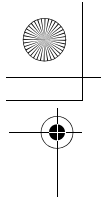

Event Data Recording

To read data recorded by an EDR, special equipment is required, and access to the vehicle or the EDR is needed. In addition to the vehicle manufacturer, other parties, such as law enforcement, that have the special equipment, can read the information if they have access to the vehicle or the EDR.

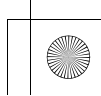
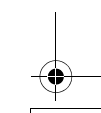
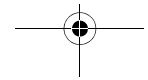
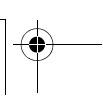
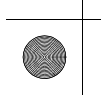
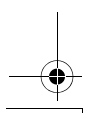
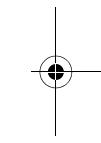
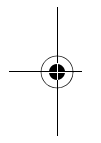

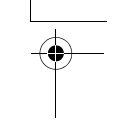
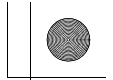
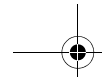
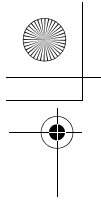

Horizontal dashed lines for writing, consisting of 10 parallel lines spaced evenly down the page.

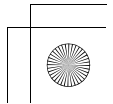
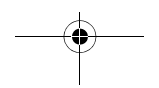
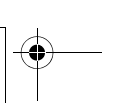
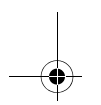
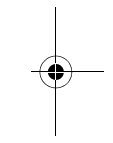
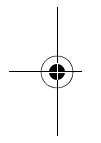

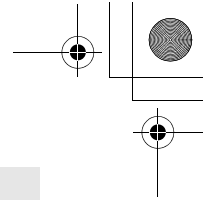
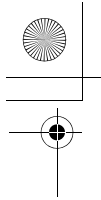

# *Seat and restraint systems*

Seats .....	4-2
Seat arrangement .....	4-3
Seats and restraint systems .....	4-4
Front seats .....	4-4
Rear seats .....	4-8
Head restraints .....	4-9
Making a cargo area .....	4-11
Making a flat seat .....	4-14
Seat belts .....	4-15
Seat belt use during pregnancy .....	4-23
Seat belt pre-tensioner and force limiter systems .....	4-23
Child restraint systems .....	4-24
Maintenance and inspection of seat belts .....	4-36
Supplemental Restraint System (SRS) - airbag .....	4-36

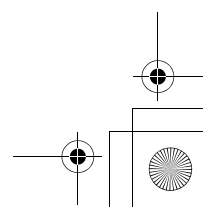
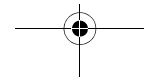
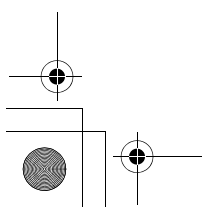
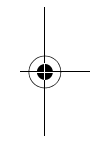
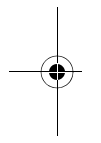



## Seats

### Seats

N00408401678

4

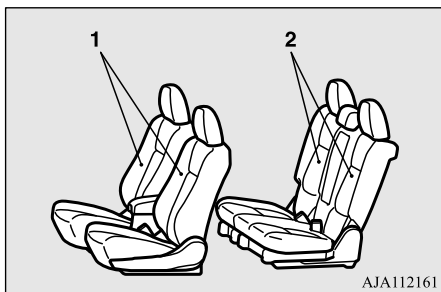

#### 1 - Front seats

- To adjust the seat forward or backward → Page 4-5
- To adjust the seatback → Page 4-5
- To adjust the seat height → Page 4-6
- To adjust the lumbar support (Driver's side only) → Page 4-7
- Heated seat → Page 4-7

#### 2 - Rear seats

- To adjust the seatback → Page 4-8
- Arm rest → Page 4-9

#### 4-2 Seat and restraint systems

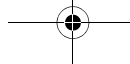

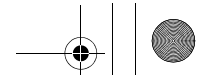



## Seat arrangement

N00401701135

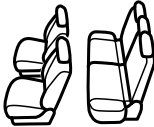
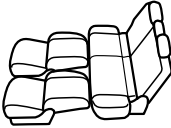
You may arrange your seats in the following positions.

Ordinary use	 <p>AGM000168</p>
Flat seat → Page 4-14	 <p>AGM000285</p>
Making a cargo area → Page 4-12	 <p>AJM100054</p>

4

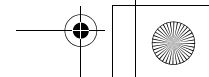
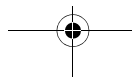

## Seats and restraint systems

### Seats and restraint systems

N00401601251

Your vehicle has seat belts and other safety features that help protect you and your passengers in an accident.

#### 4

Seat belts are the most important safety device. When worn properly, seat belts can reduce the chance of serious injury or death in various types of crashes. For added protection during a severe frontal collision, your vehicle has a Supplemental Restraint System (SRS) with airbags for the driver and passengers. The seats, head restraints, and door locks also are safety equipment, which must be used correctly.

Always check the following before you drive:

- That everyone in your vehicle is properly wearing their seat belt.
- That infants and small children are properly secured in an appropriate child restraint system in the rear seat.
- That all doors are fully closed and locked.
- That seatbacks are upright, with head restraints properly adjusted.

Safety equipment cannot prevent injury or death in all motor vehicle accidents. However, you can help reduce the risk of injury or death, by following the instructions in this manual.

#### 4-4 Seat and restraint systems

### ⚠ WARNING

- **Do not place objects under the seats. This could prevent the seat from locking securely, and it could lead to an accident. It may also cause damage to the seat or other parts.**

### Front seats

N00401801501

Position the driver's seat as far back as possible while maintaining a position that still enables you to fully apply the pedals, easily control the steering wheel and safely operate the vehicle.

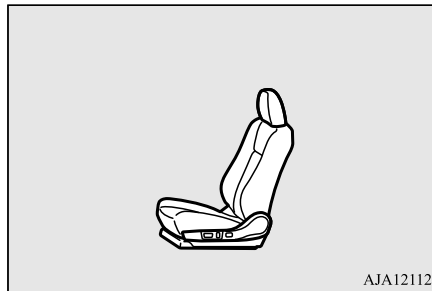

AJA121125

### ⚠ WARNING

- **Do not attempt to adjust the seat while driving. This can cause loss of vehicle control and result in an accident.**

### ⚠ WARNING

- **After adjusting the seat, make sure that it is securely locked into position.**
- **To reduce the risk to the driver of serious injury or death during deployment of the driver's airbag, always properly wear the seat belt and adjust the driver's seat as far back as possible while maintaining a position that still enables you to fully apply the pedals, easily control the steering wheel, and safely operate the vehicle.**
- **To reduce the risk to the front passenger of serious injury or death during deployment of the passenger's airbag, always properly wear the seat belt and adjust the front passenger's seat as far back as possible.**
- **Always place children 12 years old and under in the rear seat and use appropriate child restraint systems.**

### ⚠ CAUTION

- **Make sure that the seat is adjusted by an adult. If it is adjusted by a child, an unexpected accident might occur.**
- **Do not place a cushion or the like between your back and the seatback while driving. The effectiveness of the head restraints will be reduced in the event of an accident.**
- **When sliding the seats, be careful not to catch your hand or leg.**

Front seats

**CAUTION**

- When sliding or reclining the seat rearward, pay careful attention to the rear seat passengers.
- When adjusting the front seat while the rear seat is folded, be careful not to apply strong force to the flipped rear seat cushion. Doing so could cause damage to the cover of the front seat and the fitting of the rear seat cushion.

**To adjust the seat forward or backward**

N00401901401

Operate the switch forward or backward to move the seat to the desired position. Release the switch to lock the seat in place.

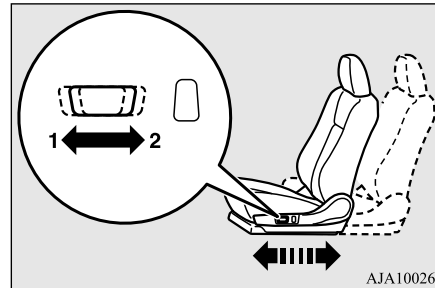

- 1- Forward (toward the front of the vehicle)
- 2- Backward (toward the rear of the vehicle)

**NOTE**

- To prevent the 12 V starter battery from completely discharging, operate the power seat with the Plug-in Hybrid EV System running.

**To adjust the seatbacks**

N00402001454

Operate the switch in the direction of the arrows to adjust the seatback.

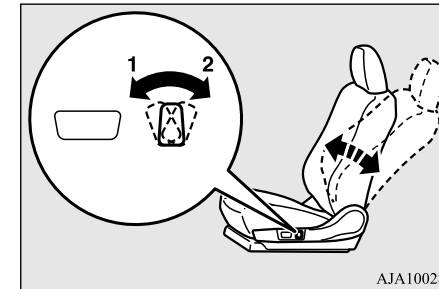

- 1- Move forward
- 2- Move backward

**NOTE**

- To prevent the 12 V starter battery from completely discharging, operate the power seat with the Plug-in Hybrid EV System running.

4

## Front seats

4

### **WARNING**

● To reduce the risk of serious injury or death in the event of an accident or sudden stop, all seatbacks should be kept in the upright position while the vehicle is in motion.

Seat belt performance during an accident can be adversely affected if the seatbacks are reclined. The more a seatback is reclined, the more likely seat belt performance will be adversely affected. If the seat belt is not properly positioned against the body during an accident, there is increased risk you will slide under the belt and receive serious injury or death.

### To adjust the seat height

N00402101312

Operate the switch in the direction of the arrows to raise or lower the seat.

### **NOTE**

● To prevent the 12 V starter battery from completely discharging, operate the power seat with the Plug-in Hybrid EV System running.

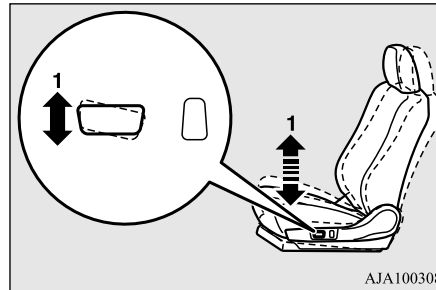

1- Raise or lower the front end of the seat

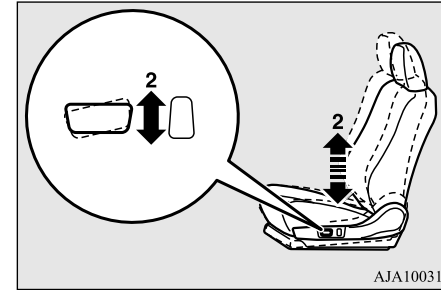

2- Raise or lower the back end of the seat

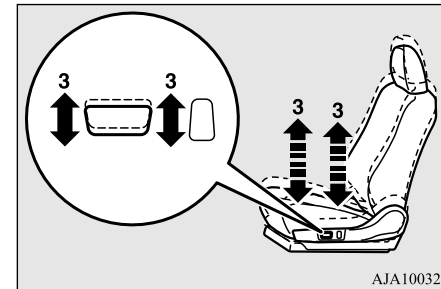

3- Raise or lower the entire seat



## To adjust the lumbar support (Driver's side only)

N00402201179

A lumbar support is included in the seatback of the driver's seat.

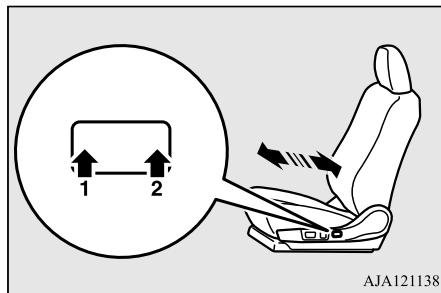

AJA121138

- 1- Strong
- 2- Weak

## Heated seat

N00435601506

The heated seats can be operated by pushing the switch when the operation mode of the power switch is in ON. The indicator light (A) will illuminate while the heater is on.

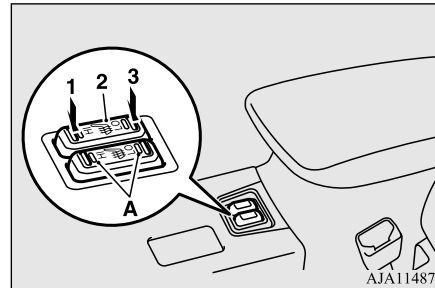

AJA114875

- 1 (HI) - Heater high  
(for quick heating)
- 2 (neutral position) - Heater off
- 3 (LO) - Heater low  
(to keep the seat warm)

## ⚠ WARNING

- Persons who are unable to feel temperature change or skin pain due to age, illness, injury, medication, alcohol use, fatigue or other physical conditions or who have sensitive skin may suffer burns when using the heated seat even at low temperatures. To reduce the risk of burns, people with such conditions must use care when using the heated seat.

## ⚠ CAUTION

- Switch off the heated seats when not in use. Operate the heaters at the "HI" position for quick heating. After the seat has become warm, set the heater switch to the "LO" position to keep it warm. Slight variations in the seat temperature may be felt while using the heated seats. This is caused by the operation of the heater's internal thermostat and does not indicate a malfunction.
- Do not place heavy objects on the seat or stick pins, needles, or other pointed objects into the seat.
- Do not place a blanket, cushion, or other insulating material on the seat while using the heater; doing so can cause the heater element to overheat.
- When cleaning the seat, do not use benzine, kerosene, gasoline, alcohol, or other organic solvents; doing so can cause damage not only to the surface of the seat, but also to the heater.

## Rear seats

### CAUTION

- If water or any other liquid is spilled on the seat, allow it to dry thoroughly before attempting to use the heater. Turn the heater off immediately if it appears to be malfunctioning during use.

4

### Rear seats

N00402501244

When sitting in the middle seating position of the rear seat, adjust the head restraints to an appropriate height where they lock in position. Refer to “Head restraints” on page 4-9.

### To adjust the seatbacks

Pull the lever up and adjust the seatback by hand to the desired position, and release the lever. The seatback will lock in place.

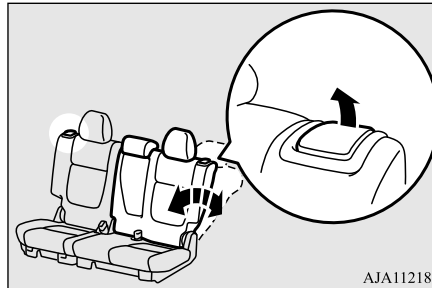

### NOTE

- You can adjust the seatback forward or backward on either side separately.

### WARNING

- To reduce the risk of serious injury or death in the event of an accident or sudden stop, all seatbacks should be kept in the upright position while the vehicle is in motion.
- Seat belt performance during an accident can be adversely affected if the seatbacks are reclined. The more a seatback is reclined, the more likely seat belt performance will be adversely affected. If the seat belt is not properly positioned against the body during an accident, there is increased risk you will slide under the belt and receive serious injury or death.
- When a person is sitting in the middle seating position of the rear seats, the two sides of the rear seats must have the same seatback angle.

## Arm rest

N00403001321

To use the arm rest, tilt the arm rest down for use as shown.

The arm rest includes a cup holder.

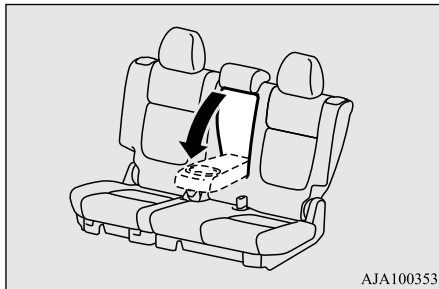

AJA100353

## NOTE

- Never sit on an arm rest. Doing so could damage the arm rest.

## Head restraints

N00404301624

Head restraints can reduce the risk of a whiplash injury if your vehicle is hit from the rear. The head restraints are equipped in the illustrated position.

To maximize the effectiveness of the head restraints, adjust the seatback to the upright position, and the head restraint to the proper position. Sit back against the seatback with your head close to the head restraint.

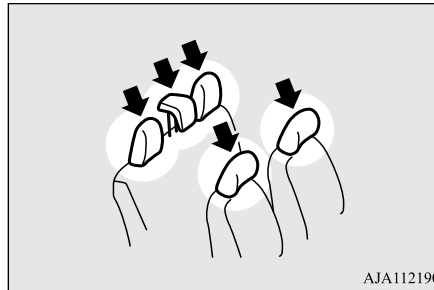

AJA112190

## WARNING

- Driving without the head restraints in place can cause you and your passengers serious injury or death in an accident. To reduce the risk of injury in an accident, always make sure the head restraints are installed and properly positioned when the seat is occupied.
- In order to minimize the risk of a neck injury due to a rear impact, the seatback must be adjusted to the upright position and the head restraint must be adjusted to the proper position before vehicle operation. The driver should never adjust the seat while the vehicle is in motion.
- Never place a cushion or similar device on the seatback. This can adversely affect head restraint performance by increasing the distance between your head and the restraint.

## Head restraints

### Adjustment of the head restraint height

#### Front seats

4

To reduce the risk of injury in an accident, adjust the head restraint height so that the center of the restraint is at your ear level when seated. Any person too tall for the restraint to reach their ear level when seated should raise the restraint to the highest locked position.

- To raise the restraint, pull it straight up.
- To lower the restraint, push down on it while pressing the lock knob (A) in the direction shown by the arrow.
- After adjusting the height, push down on the restraint to make sure it is locked in position.

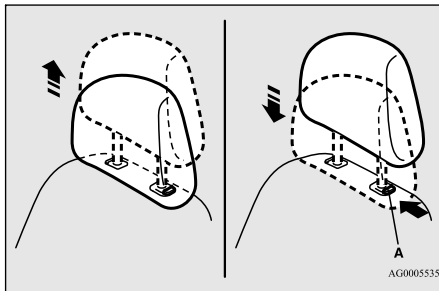

#### Rear center seat

To reduce the risk of injury in an accident, pull up the head restraint to the locked position.

- To raise the restraint, pull it straight up.
- To lower the restraint, push down on it while pressing the lock knob (A) in the direction shown by the arrow.
- After adjusting the height, push down on the restraint to make sure it is locked in position.

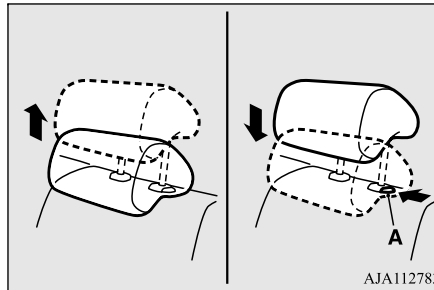

#### WARNING

- When a person sits in the rear center seating position, pull up the head restraint to a height at which it locks in position. Be sure to make this adjustment before starting to drive. Serious injuries could otherwise be suffered in the result of an impact.

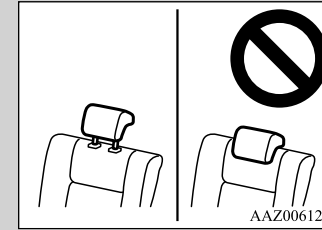

#### NOTE

- The head restraint height in the rear outboard seats cannot be adjusted.

## To remove

Press the lock knob (A) in the direction shown by the arrows. Then pull the head restraint up and out of the seatback.

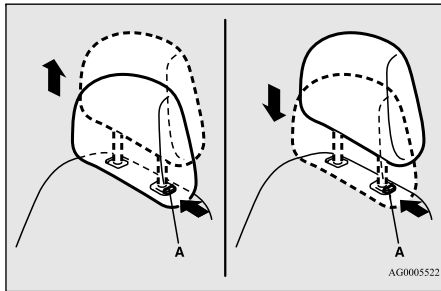

### ⚠ WARNING

- To help minimize the risk of neck injury in the event of an accident, the head restraints must be properly installed and positioned to proper height before vehicle operation.

## To install

First check that the head restraint is facing in the right direction as shown in the previous illustration, and then insert it into the seatback. Push the head restraint down while

pressing the lock knob (A) until the restraint locks into place.

### ⚠ CAUTION

- Check that the lock knob (A) is extended out as shown in the illustration. Then pull the head restraint up to make sure that it is locked in place and will not come out of the seatback.

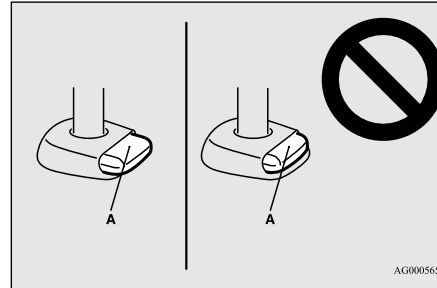

### ⚠ CAUTION

- The shape and size of the head restraint differs according to the seat. Always use the correct head restraint provided for the seat and do not install the head restraint in the wrong direction.

## Making a cargo area

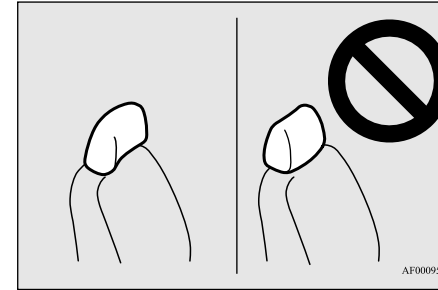

4

## Making a cargo area

N00405501128

### ⚠ WARNING

- Never adjust the seats to make a cargo area when the vehicle is in motion or on a slope. The seats could move more than necessary or move suddenly and causing a serious accident and/or injury.
- When returning a seat back to its seating position after folding down, make sure that the seat is firmly secured and seat belt buckles are in proper position. If the seat is not secured, it could move causing a serious accident.
- Do not allow anyone to ride in the cargo area while the vehicle is in motion. People who are not properly seated and restrained can be seriously injured or killed in an accident.

## Making a cargo area

4

### ⚠ CAUTION

- In the cargo area, do not load the luggage higher than the top of the seats and make sure that the luggage is firmly secured. Restricted rear vision or flying objects entering the passenger compartment during sudden braking could result in a serious accident and/or injury.
- Seats should always be operated by an adult. Seat adjustments by a child could lead to an unexpected accident.
- When adjusting the seats, be careful not to catch your hand or leg. Personal injury could result.

### 📖 NOTE

- When the seatback of a front seat is reclined, return it to the upright position before driving.

## Folding the rear seats

N00405701159

The rear seat can be folded to create an additional cargo area.

### 📖 NOTE

- You can separately fold the right and left side of the rear seat.

## To fold the rear seat

1. When folding the left side rear seat, store the seat belt for the middle seating position of the rear seat.  
Refer to “Detachable center seat belt for rear seat” on page 4-19.
2. Lower the head restraint for rear middle seating position to its lowest position.  
Refer to “Head restraints” on page 4-9.
3. Pull the strap (A), then fold forward the head restraints for rear outside seating position.

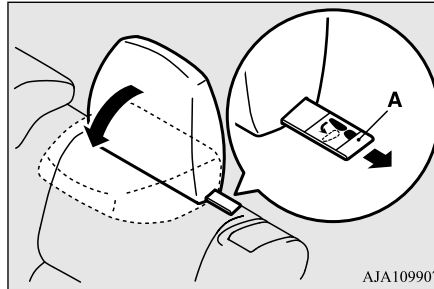

4. Pull the strap (B), then flip the seat cushion forward.

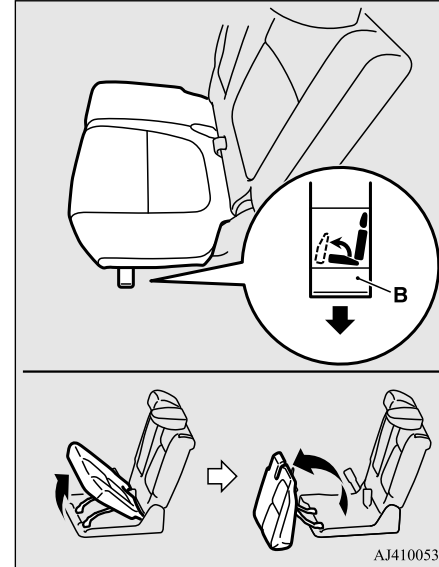

## Making a cargo area

### CAUTION

- Do not fold the rear seat while the 120 V AC power supply on the back of the floor console box is being used or while the lid of the 120 V AC power supply is open. Doing so may damage the 120 V AC power supply, its lid, a connected appliance and/or the rear seat. Also, this could lead to an electrical shock.



5. Fold forward the seat belt buckle.

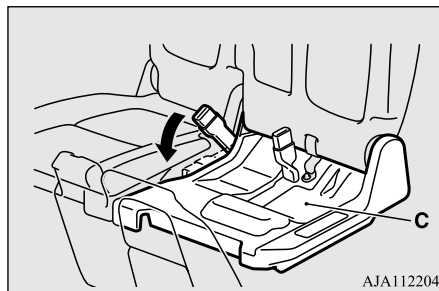

### CAUTION

- Do not allow any person to get on the plastic cover (C), and do not place luggage on it. Doing so could damage the plastic cover.

6. Pull up the lever (D), then fold the seat-back forward.

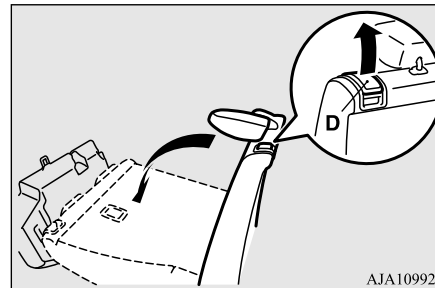

### CAUTION

- Do not allow any person to sit on the flipped seat cushion, and do not place luggage on it. The seat's mounting fittings could bend under the weight, making it impossible for the seat cushion to be secured when it returns to the original position.

### To return

- Raise the seatback until it locks securely into place.

- While lifting the seat belt buckle (A), gently lower the seat cushion. Make sure that there is a hook (B) at the position shown in the illustration.

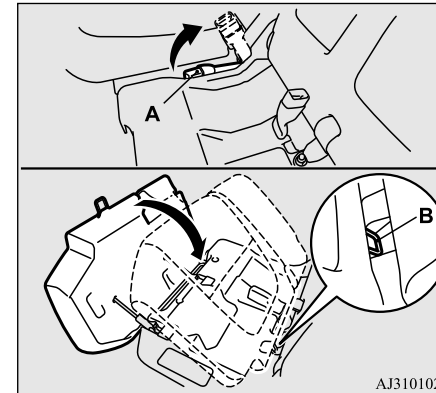

4

### NOTE

- A rubber strap (C) is attached to the seat belt buckle for the left outboard seating position. This helps raise the seat belt buckle while the seat cushion returns to the original position.

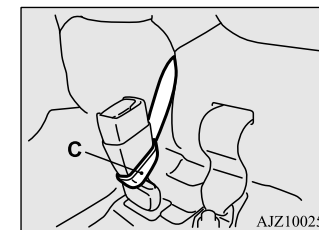

### Making a flat seat

3. Push down the seat cushion until it locks securely into place.

4

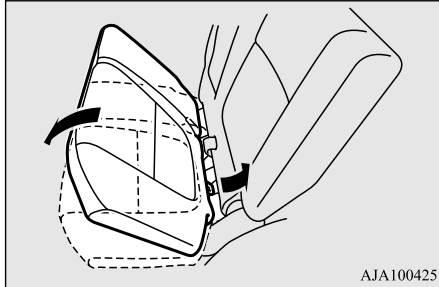

4. Make sure that all seat belt buckles are properly positioned on the seat cushion.
5. Return the folded head restraint to its original position.

#### **WARNING**

- Ensure that the head restraints are returned to their original positions before the seats are occupied. Failure to do so could cause serious injury if involved in an accident.

6. If the center seat belt is stored;
  - Pull out the detachable anchor plate (D) from the seatback.
  - Pull the small latch plate (E) slowly and insert it into the detachable anchor plate until a click is heard.

- Make sure that the seat belt is not twisted.
- For details, refer to “Detachable center seat belt for rear seat” on 4-19.

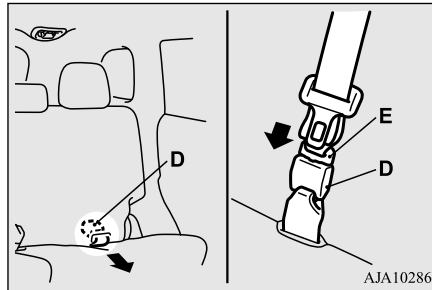

### Making a flat seat

N00404801179

The entire interior of the vehicle may be used for sleeping accommodations by removing the head restraints and fully reclining all the seats when the vehicle is stopped.

#### **WARNING**

- Never drive with passengers or cargo on the flat seat. This is extremely dangerous and can cause severe or fatal injury or death in an accident or if heavy braking is required.

#### **CAUTION**

- Adjust the seats only when the vehicle is stopped in a safe place.
- Seat should be adjusted only by adults to avoid accidents.
- When sliding the seats, be careful not to catch your hand or leg.
- Do not walk around on top of the seats after they have been laid flat because the footing is uneven. It is safest to move about on your hands and knees.
- To ensure the seats are locked securely, attempt to move them back and forth.
- Do not jump on or drop heavy objects on the seatbacks.
- To raise the seatback of the front seat, firmly place your hand on the seatback, pull the seatback lock knob up, and raise the seatback slowly. (Refer to “To adjust the seatback” on page 4-5.) Do not let children adjust the seatback.



## Seat belts

1. Remove the head restraints from the front seats and raise the arm rest on the rear seats.

For vehicles with a cargo area cover, remove the cover.

(Refer to “Head restraints” on page 4-9, “Arm rest” on page 4-9 and “Cargo area cover” on page 5-227.)

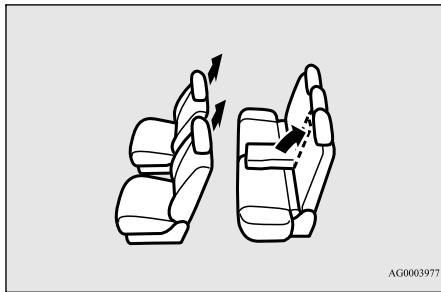

2. Slide the front seats fully forward, then recline their seatbacks backward to achieve a flat surface.

(Refer to “To adjust the seat forward or backward” on page 4-5 and “To adjust the seatback” on page 4-5.)

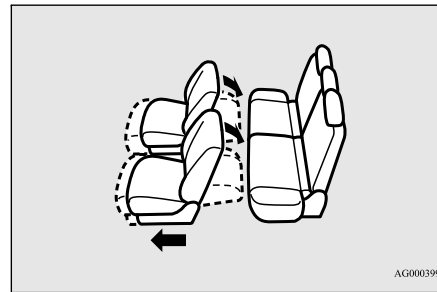

3. Recline the seatbacks of the rear seats.

(Refer to “To adjust the seatback” on page 4-8.)

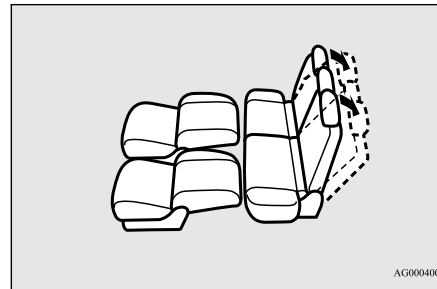

4. The flat seat configuration is now complete.

To return the seats to the normal position, reverse the above procedure.

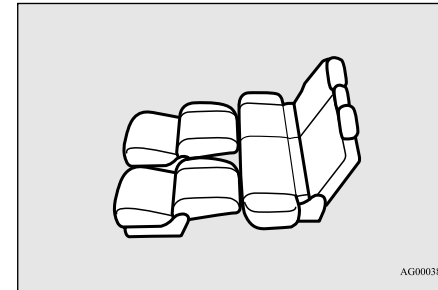

4

## Seat belts

N00406001582

Seat belts are installed in your vehicle to help reduce the risk of injury to the driver and passenger in the event of an accident. Always use the provided seat belts.

Carefully review the following information for proper seat belt usage.

### **⚠ WARNING**

- To help reduce the risk of injury or death in an accident, seat belts and child restraint systems must always be used. Refer to “Child restraint systems” on page 4-24 for additional information.

## Seat belts

4

### ⚠ WARNING

- Never use one seat belt for more than one person.
- Never carry more people in your vehicle than there are seat belts.
- Always adjust the seat belt for a snug fit.
- Always place the shoulder belt over your shoulder and across your chest. Never put it behind you or under your arm.
- Always wear the lap belt as low as possible across your hips, not around your waist.
- Never insert any foreign object, such as a piece of plastic, paper clip, button or coin, into the seat belt buckle.

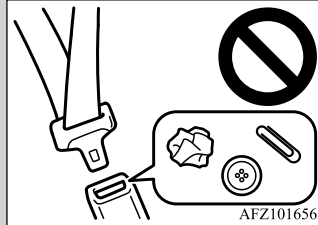

- Never modify or alter the seat belts in your vehicle.
- To reduce the risk to the driver of serious injury or death during deployment of the driver's airbag, always properly wear the seat belt and adjust the driver's seat as far back as possible while maintaining a position that still enables you to fully apply the pedals, easily control the steering wheel, and safely operate the vehicle.

### ⚠ WARNING

- To reduce the risk to a front seat passenger of serious injury or death from a deploying airbag, make sure the passenger always wears the seat belt properly, remains seated all the way back and upright in their seat, and moves the seat as far back as possible. Refer to "Supplemental Restraint System (SRS) - airbag" on page 4-36 for additional information.
- Never hold an infant or child in your arms or on your lap when riding in this vehicle even when you are wearing your seat belt. Never place any part of the seat belt you are wearing around an infant or child. Failure to follow these simple instructions creates a risk of serious injury or death to your child in the event of an accident or sudden stop.
- Children 12 years old and under should always ride in the rear seat and be properly restrained. This reduces their risk of serious injury or death in an accident, especially due to a deploying front passenger's airbag. Refer to "Child restraint systems" on page 4-24 for additional information.
- Any child who is too small to properly wear a seat belt must be properly restrained in an appropriate child restraint system.
- Infants MUST be placed in a rear-facing child safety seat and positioned in the rear seat.

### ⚠ WARNING

- In the event of an accident, all seat belt assemblies, including retractors and attachment hardware, should be inspected by a certified Mitsubishi EV dealer to determine whether replacement is necessary.
- Do not let children play with the seat belts. If children play with the seat belts by wrapping them around their bodies, the seat belt may retract and become tight. This can result in a serious injury or death, such as suffocation. This can occur even if the vehicle is parked. If the child cannot be released from the seat belt, use an appropriate tool such as a knife or scissors to cut the seat belt.

## Seat belt instructions

N00406201513

All seats are equipped with a seat belt which uses one combined lap-and-shoulder belt with an emergency locking retractor.

This system is designed to provide both comfort and safety. It permits full extension and automatic retraction of the belts during normal vehicle operation. A sensing device inside the belt retractor is designed to lock the retractor in the event of a sudden change in the vehicle's motion.

**NOTE**

- For instructions on installing a child restraint system using a seat belt, refer to “Installing a child restraint system using the seat belt” on page 4-32.

1. Occupants should always sit back in their seats with their backs against the upright seatback. To reduce the risk of serious injury or death during deployment of the airbag, adjust the driver’s seat as far back as possible while maintaining a position that still enables you to fully apply the pedals, easily control the steering wheel, and safely operate the vehicle. The front passenger seat should also be moved as far back as possible. Refer to “Supplemental Restraint System (SRS) - airbag” on page 4-36. Also refer to “To adjust the seat forward or backward” on page 4-5.



**WARNING**

- To reduce the risk of serious injury or death in the event of an accident or sudden stop, all seatbacks should be kept in the upright position while the vehicle is in motion.

Seat belt performance during an accident can be adversely affected if the seatbacks are reclined. The more a seatback is reclined, the more likely seat belt performance will be adversely affected. If the seat belt is not properly positioned against the body during an accident, there is increased risk you will slide under the belt and receive serious injury or death.

2. Before using the center seat belt for second row, make sure that the detachable anchor is securely latched and the seat belt is not twisted. For details, refer to page 4-19.

3. Grasp the latch plate and slide it up the webbing so that it easily pulls across your body.



4

4. Pull the seat belt out slowly while holding the latch plate. Push the latch plate into the buckle until you hear a “click”. Pull up on the belt to be sure the latch plate is locked securely in the buckle.



## Seat belts

### NOTE

- If the seat belt locks up and cannot be pulled out, pull it once with force and let it retract all the way. Then, pull the belt out slowly once again.

4

5. The lap part of the belt must always be worn low and snug across the hips. Pull up on the shoulder portion of the belt to take up any slack in the lap belt.



### NOTE

- With the exception of the seat belt for the driver, the seat belts in all other seating positions are equipped with an Automatic Locking Retractor (ALR) function. If you pull the seat belt fully out of the retractor, the retractor will switch to its ALR child restraint installation function (see page 4-32). When the ALR function has been activated, the seat belt will only retract. If this happens, let the belt fully retract, then pull the seat belt back out, repeating steps 1 through 4.

### WARNING

- Be sure the lap belt portion fits snugly and is worn as low as possible across the hips, not around the waist. Failure to follow this instruction will increase the risk of serious injury or death in the event of an accident.
- Be sure the seat belt webbing is not twisted when worn. Twisted webbing may adversely affect seat belt performance.

6. To release the belt, press the button on the buckle and allow the belt to retract.

If the belt does not retract smoothly, pull it out and check for kinks or twists in the webbing. Then make sure it remains untwisted as it retracts.

### NOTE

- If the seat belt (A) or ring (B) becomes dirty, the belt may not retract smoothly. If the seat belt and ring are dirty, clean them with a mild soap or detergent solution.

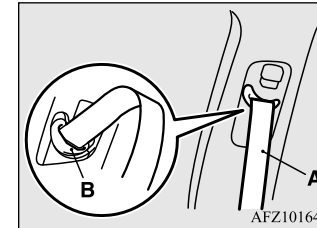

## Detachable center seat belt for rear seat

N00409900077

The center seat belt for the rear seat can be detached to fold the left side rear seat. This seat belt must be worn correctly as illustrated.

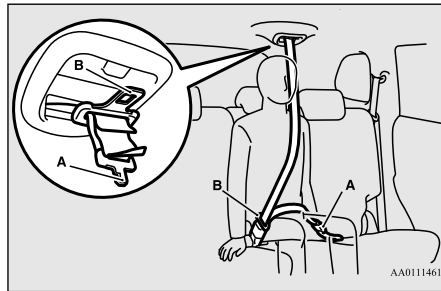

### ⚠ WARNING

- Never detach the center seat belt except when the left side seat back in the rear seat is folded. Using the center seat belt with the detachable anchor unlatched increases the risk of serious injury or death in an accident. Make sure the small latch plate (A) is properly latched to the detachable anchor before the center seat belt is used.

## To attach

1. Pull out the detachable anchor from the storage pocket on seat back cushion.
2. Pull out the small latch plate (A) and then pull out the latch plate (B) by tilting it as shown in the illustration.

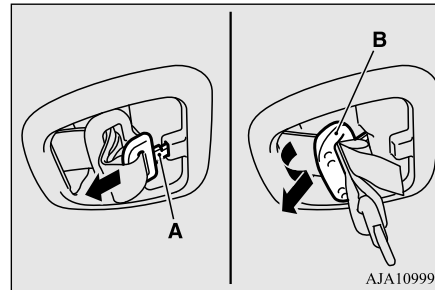

### 📖 NOTE

- Pulling out the latch plate by force may damage the headliner.

3. Pull the small latch plate (A) slowly and insert it into the detachable anchor (C) until a click is heard. Make sure that the seat belt is not twisted.

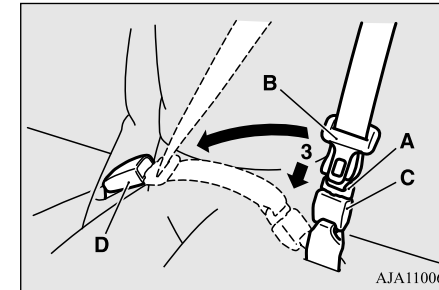

4

### 📖 NOTE

- If the seat belt locks up and cannot be pulled out, pull it once with force and let it retract all the way. Then, pull the belt out slowly once again.
- The seat belt can be buckled up by inserting the latch plate (B) into the buckle (D) like other seat belts.
- If the seat belt switch to the ALR child restraint installation function and cannot be pulled out, detach the latch plate (B). Refer to “Installing a child restraint system using the seat belt” on page 4-32.

## Seat belts

### To detach

1. While holding the seat belt, insert a metal plate, such the latch plate of the seat belt or a key, into the slit (E) on the detachable anchor (C) and release the center seat belt from the detachable anchor.

4

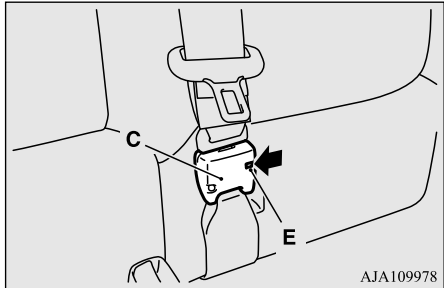

2. Retract the seat belt slowly by holding the seat belt.

#### NOTE

- If the seat belt is not held, the seat belt will rapidly retract. This could cause damage to the interior trim.

3. After the seat belt has retracted completely, insert the latch plate (B) into the upper slit (F), and then insert the small latch plate (A) into the lower slit (G).

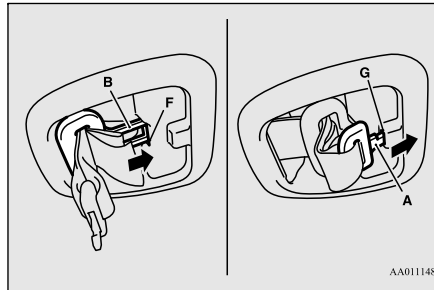

4. Store the detachable anchor in the storage pocket on the seatback.

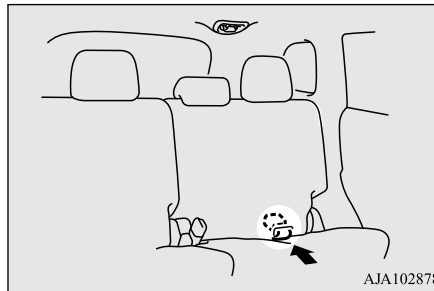

### Driver's seat belt reminder/warning light and display

N00418401424

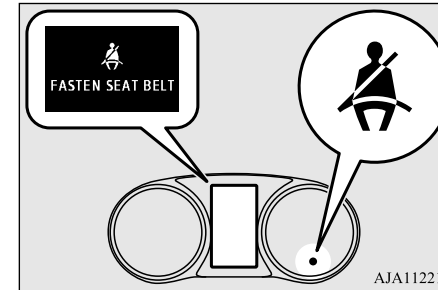

A tone and warning light are used to remind the driver to fasten the seat belt.

If the operation mode of the power switch is put in ON without the driver's seat belt being fastened, a warning light will come on and a tone will sound for approximately 6 seconds to remind you to fasten your seat belt.

If the vehicle is driven with the seat belt still unfastened, the warning light will blink and the tone will sound intermittently until the seat belt is fastened. At the same time, "FASTEN SEAT BELT" is displayed on the information screen in the multi-information display.

**⚠ WARNING**

- In order to reduce the risk of serious injury or death in an accident, always fasten your own seat belt. Do not allow anyone to ride in your vehicle unless he or she is also seated and fastening a seat belt. Children should additionally be restrained in a secure child restraint system.

**📖 NOTE**

- If the seat belt subsequently remains unfastened, the warning light and the tone will issue further warnings each time the vehicle starts moving from a stop.

### Front passenger seat belt warning light

N00418301319

The front passenger seat belt warning light is located as shown in the illustration.



AJA119841

When the operation mode of the power switch is put in ON, this indicator normally comes on and goes off a few seconds later.

The light comes on when a person sits on the front passenger seat but does not fasten the seat belt. It goes off when the seat belt is subsequently fastened.

**⚠ WARNING**

- When a child booster seat is used on the front passenger seat, the front passenger seat belt warning light will not come on, if the seat belt is not fastened when the booster seat is used. Confirm that the child is wearing the seat belt properly.

**⚠ WARNING**

- Do not install any accessory or sticker that makes the light difficult to see.

### Adjustable seat belt shoulder anchor (front seats)

N00406301354

The seat belt shoulder anchor height can be adjusted. To move the anchor down, press the lock knob (A) and slide the anchor down to the desired position. To move the anchor up, slide the anchor up to the desired position.

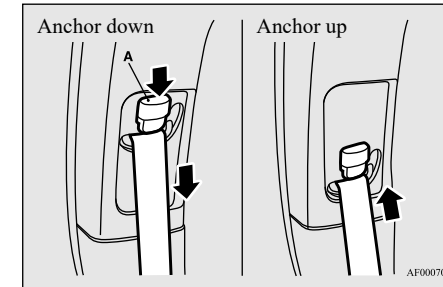

AF0007028

## Seat belts

4

### ⚠ WARNING

- Always adjust the shoulder belt anchor so that the shoulder belt is positioned across the center of your shoulder without touching your neck. The shoulder belt should not be able to fall off your shoulder. Failure to follow this instruction can adversely affect seat belt performance and increase the risk of serious injury or death in the event of an accident.
- Adjust the shoulder belt anchor only when the vehicle is not in motion.
- Make sure the anchor is securely locked in position after adjusting it.

### Storing the seat belts for the rear seat (outboard seating positions)

N00406501125

When seat belts for the rear seat outboard seating position is not used, the seat belts can be stored.

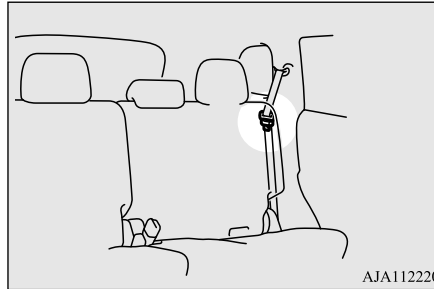

Put the seat belt webbing in the back slot (A) on the clip and insert the metal plate of the latch plate into the front slot (B) as shown in the illustration.

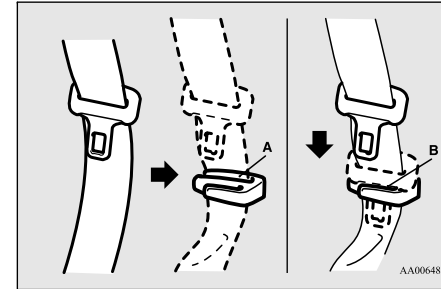



## Seat belt extender

N00406701202

If your seat belt is not long enough, even when fully extended, a seat belt extender must be obtained. The extender may be used for either of the front seats.

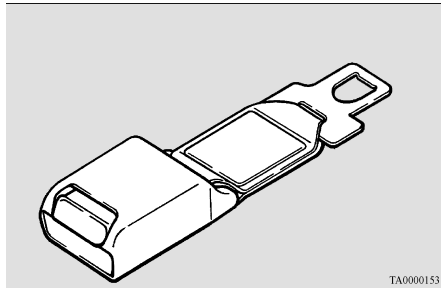

### ⚠ WARNING

- The extender should only be used if the existing belt is not long enough. Anyone who can use the standard seat belt should not use an extender. Unnecessary use of an extender can adversely affect seat belt performance in an accident.
- When not required, the extender must be removed and stowed.

## Seat belt use during pregnancy

N00406800134

Seat belts work for everyone, including pregnant women. Like all occupants, pregnant women are more likely to be seriously injured or killed in an accident if they do not wear seat belts.

### ⚠ WARNING

- To reduce the risk of serious injury or death to pregnant women and unborn children in an accident, pregnant women should always wear a seat belt. The lap portion of the seat belt should be worn snug and low across the hips and below the rounding. Consult your doctor if you have any additional questions or concerns.

## Seat belt pre-tensioner and force limiter systems

N00417701749

The driver's and front passenger's seats each have a seat belt equipped with a pre-tensioner system and force limiter system.

## Seat belt use during pregnancy

## Pre-tensioner system

The driver and front passenger seat belts are equipped with a seat belt pre-tensioner system. In a moderate-to-severe frontal or side collision or when a rollover or overturning of the vehicle is detected, the pre-tensioner system operates simultaneously with the deployment of the front airbags, side airbags or curtain airbags.

The seat belt pre-tensioners are located in the driver's and front passenger's seat belt retractors (A) and in the front passenger seat's final anchor (B). When activated, the pre-tensioners quickly draw back seat belt webbing and increase seat belt performance.

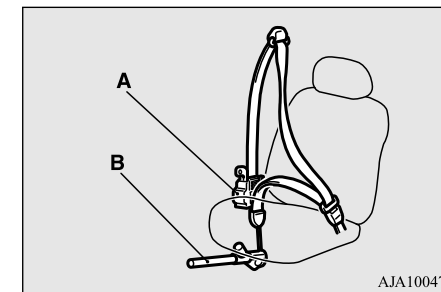

The seat belt pre-tensioner system includes the following components:

## Child restraint systems

4

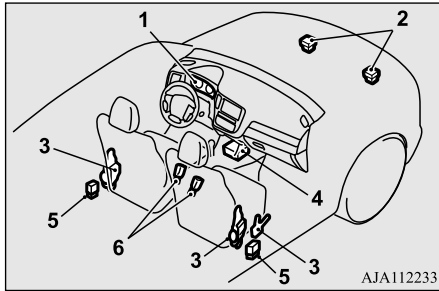

- 1- SRS warning light
- 2- Front impact sensors
- 3- Seat belt pre-tensioner
- 4- Airbag control unit
- 5- Side impact sensors
- 6- Seat belt buckle switches

The airbag control unit monitors the readiness of the electronic parts of the system whenever the operation mode of the power switch is in ON. These include all of the items listed above and all related wiring.

The seat belt pre-tensioners will operate under the same conditions as the airbag control unit.

When the seat belt pre-tensioners activate, some smoke is released and a loud noise will be heard. The smoke is not harmful, but care should be taken not to intentionally inhale it,

as it may cause some temporary irritation to people with respiratory problems.

Even in the event of a severe impact, the pre-tensioners will not operate if the seat belts are not fastened. The seat belt pre-tensioners may not activate in certain collisions, even though the vehicle may appear to be severely damaged. Such non-activation does not mean that something is wrong with the seat belt pre-tensioner system, but rather that the collision forces were not severe enough to activate the system.

### ⚠ WARNING

- **The seat belt pre-tensioner system is designed to work only once. After the seat belt pre-tensioners have been activated, they will not work again. They must promptly be replaced and the entire seat belt pre-tensioner system inspected by a certified Mitsubishi EV dealer.**

### SRS warning

This warning light tells you if there is a problem involving the SRS airbags and/or the seat belt pre-tensioner system. Refer to “SRS warning light/display” on page 4-42.

## Force limiter system

N00408900126

In the event of an accident, the seat belt force limiter system will help reduce the force applied to the driver and front seat passenger.

## Child restraint systems

N00407101900

When transporting infants or small children in your vehicle, an appropriate child restraint system must always be used. This is required by law in the U.S. and Canada.

Child restraint systems specifically designed for infants and small children are offered by several manufacturers. Choose only a child restraint system with a label certifying that it complies with Federal Motor Vehicle Safety Standard 213 (FMVSS 213) or Motor Vehicle Restraint Systems and Booster Seats Safety Regulations (RSSR). Look for the manufacturer’s statement of compliance on the box and child restraint system itself.

The child restraint system should be appropriate for your child’s weight and height, and should properly fit your vehicle’s seat.

For detailed information, refer to the instruction manual accompanying the child restraint system.

## Recommendations for child restraint system selection

All children should be properly restrained in a restraint device that offers the maximum protection for their size and age as specified by local, state, or provincial laws.

Be sure to check local, state, or provincial requirements for child size and age that may vary from the recommendations listed below.

- Children less than 2 years old and who weigh 40 pounds (18 kg) or less **MUST** ride in a rear-facing child safety seat that **MUST ONLY** be used in the rear seat.
- Children older than 2 years of age and who weigh less than 60 pounds (27 kg) or who are less than 57 inches (145 cm) tall must be in an appropriate child restraint system used only in the rear seat.
- Children who weigh more than 60 pounds (27 kg) or who are more than 57 inches (145 cm) tall, regardless of age, should use a suitable child seat or a booster seat in the rear seat until the vehicle's lap-and-shoulder belt fits them properly.

### ⚠ WARNING

- All children must be seated in the rear seat, and properly restrained. Accident statistics show that children of all sizes and ages are safer when properly restrained in the rear seat, rather than in the front seat.
- Be sure to select a child restraint system that is appropriate not only for the child's size and age but also for your vehicle. Some child restraint systems may not fit your vehicle properly.
- Any child who is too large to use a child restraint system should ride in the rear seat and wear the lap-and-shoulder belt properly. The shoulder belt must be positioned over the shoulder and across the chest, not across their neck, and with the lap belt positioned low on the child's hips, not across their stomach. If necessary, a booster seat should be used to help achieve a proper seat belt fit. Follow the booster seat manufacturer's instructions. Only use a booster seat that is certified as complying with Federal Motor Vehicle Safety Standards or Motor Vehicle Restraint Systems and Booster Seats Safety Regulations.

### ⚠ WARNING

- Never hold an infant or child in your arms or on your lap when riding in this vehicle, even when you are wearing your seat belt. Never place any part of the seat belt you are wearing around an infant or child. Failure to follow these simple instructions creates a risk of serious injury or death to your child in the event of an accident or sudden stop.

4



## Child restraint systems

4

### ⚠ WARNING

- Your vehicle is also equipped with a front passenger's airbag. Never put REAR-FACING CHILD RESTRAINT SYSTEMS or INFANT RESTRAINT SYSTEMS in the front passenger seat. This places the infant too close to the passenger's airbag. During deployment of that airbag, the infant can be seriously injured or killed. Rear-facing child restraint systems or infant restraint systems must only be used in the rear seat.

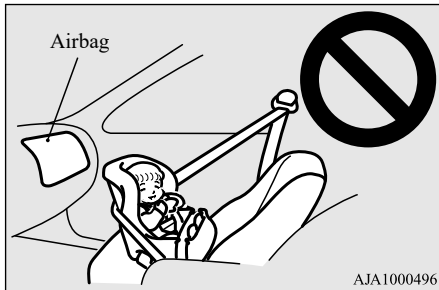

### ⚠ WARNING

- FRONT-FACING CHILD RESTRAINT SYSTEMS should be used in the rear seat whenever possible. If one must be used in the front passenger seat, move the seat to the most rearward position and make sure the child stays in the child restraint system, properly restrained. Failure to follow these instructions could result in serious injury or death to the child.



### ⚠ WARNING

- It is important to use an approved rear-facing infant restraint until the infant is one year old (unless the infant outgrows the seat sooner). This allows the infant's neck and spine to develop enough to support the weight of their head in the event of an accident.

### ⚠ WARNING

- When installing a child restraint system, follow the instructions provided by the manufacturer and follow the directions in this manual. Failure to do so can result in serious injury or death to your child in an accident or sudden stop.
- After installation, push and pull the child restraint system back and forth, and side to side, to see that it is firmly secured. If the child restraint system is not installed securely, it may cause injury to the child or other occupants in the event of an accident or sudden stop.
- When not in use, keep your child restraint system secured with the seat belt, or remove it from the vehicle, in order to prevent it from being thrown around inside the vehicle during an accident.

**NOTE**

- Before purchasing a child restraint system, try installing it in the rear seat to ensure proper fit. Due to the location of the seat belt buckles and the shape of the seat cushion, it may be difficult to securely install some manufacturer's child restraint systems. If the child restraint system can be pulled forward or to either side easily on the seat cushion after the seat belt has been tightened, choose another manufacturer's child restraint system.
- Depending on the seating position in the vehicle and the child restraint system that you have, the child restraint system can be attached using one of the following two methods:
  - Attach to the lower anchorage in the rear seat ONLY if the child restraint system is compatible with the LATCH system (See page 4-27).
  - Attach to the seat belt (See page 4-32).

**Installing a child restraint system using the LATCH (Lower Anchors and Tethers for children) system**

N00418801170

**Lower anchor locations**

The outboard seating positions in the rear seat of your vehicle are equipped with lower anchors for attaching child restraint systems compatible with the LATCH system.

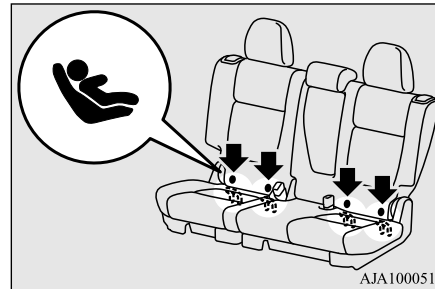

**NOTE**

- The symbols on the seatback show the location of the lower anchor points.

**Tether anchor locations**

N00418901256

Your vehicle has three attachment points on the backside of the rear seats. These are for securing a child restraint system tether strap to each of the three rear seating positions in your vehicle.

4

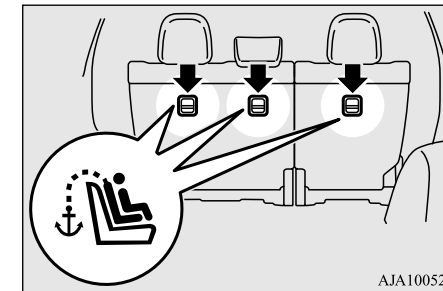

## Child restraint systems

### Examples of child restraint systems compatible with the LATCH system

N00419000198

4

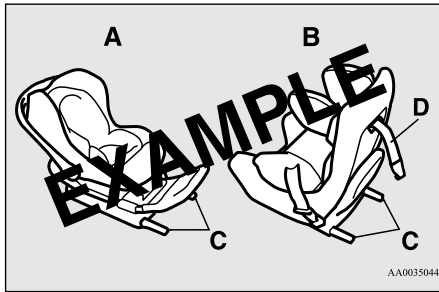

- A- Rear-facing child restraint system
- B- Front-facing child restraint system
- C- Child restraint system lower anchor connectors
- D- Tether strap  
(These are only examples.)

2. Open the gap a little between the seat cushion (A) and the seatback (B) with your hand to locate the lower anchors (C).
3. For easier access, the seatback may be reclined rearward.

Push the anchor connectors (D) on the child restraint system into the lower anchors (C) in accordance with the instructions provided by the child restraint system's manufacturer.

After it is securely fastened, adjust the seatback to four steps forward from most reclined position.

**Remember, the lower anchors (C) provided with your vehicle are designed to secure suitable child restraint systems compatible with the LATCH system in the outboard positions of the rear seats only. The anchor connectors are NOT designed to secure a suitable child restraint system in the middle seating position of the rear seat.**

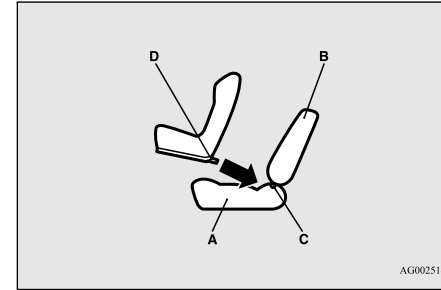

- A- Vehicle seat cushion
- B- Vehicle seatback
- C- Lower anchor
- D- Connector

### NOTE

- In order to secure a child restraint system compatible with the LATCH system, use the lower anchor points in the outboard positions of the rear seat. It is not necessary to use the vehicle's seat belt. The vehicle's seat belt, however, **MUST** be used to secure a child restraint system in the middle seating position of the rear seat.

### Using the LATCH system

N00419101343

#### Except for booster seat

1. In order to securely fasten the tether strap, remove the head restraint from the location where you wish to install the child restraint system.

Child restraint systems

4

**⚠ WARNING**

- If there is any foreign material in or around the lower anchors, remove it before installing the child restraint system. Also, make sure the seat belt is away from, not looped through or otherwise interfering with, the child restraint system. If foreign matter is not removed and/or the seat belt interferes with the child restraint system, the child restraint system will not be secured properly, could detach and move forward in the event of sudden braking or an accident, and could result in injury to the child or other vehicle occupants.
- When the vehicle is moving, do not adjust the seat where the child restraint system is installed.

**📖 NOTE**

- If it is difficult to latch the tether strap hook, turn the hook sideways.

**⚠ WARNING**

- Child restraint system tether anchors are designed only to withstand loads from correctly fitted child restraint systems. Under no circumstances are they to be used for adult seat belts, harnesses, for attaching other items, or equipment to the vehicle.

**⚠ WARNING**

- When using a child restraint in a rear seating position, always review the instructions provided with that restraint to make sure it is compatible with this vehicle and to understand how to properly install it.

Child restraints, including booster seats, come in different sizes and configurations. Depending on where you place these child restraints, and depending on their size and configuration, you may not be able to access or properly use one or more adjacent seat belt assemblies. If this occurs, the adjacent seating position or positions should not be used. Failure to use a seat belt or improper use of a seat belt can result in serious injury or death should a crash occur.

4. Latch the tether strap hook (E) of the child restraint system to the tether anchor bar (F) and tighten the tether strap so it is securely fastened.

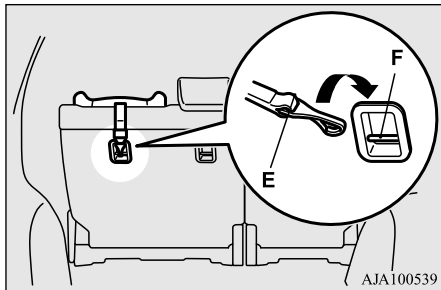

5. Before putting your child in the restraint, push and pull the restraint in all directions to be sure it is firmly secure. Do this before each use. If the child restraint system is not firmly secure, repeat steps 3 and 4.

**⚠ CAUTION**

- After removing the child restraint system, install the head restraint.

## Child restraint systems

### Booster seat

4

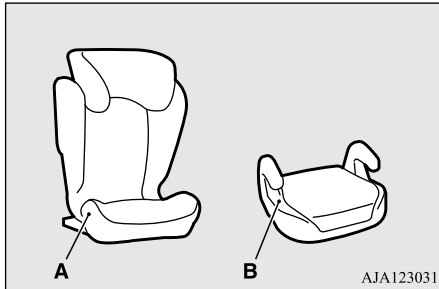

A- High back booster seat  
B- Booster cushion

### ⚠ WARNING

- To avoid injury to child, do not use the lap/shoulder belt Automatic Locking Retractor (ALR) child restraint installation function when using a booster seat with the seat belts.

### ■ High back booster seat

1. In order to securely fasten the tether strap, remove the head restraint from the location where you wish to install the high back booster seat.

2. Open the gap a little between the seat cushion (A) and the seatback (B) with your hand to locate the lower anchors (C).
3. For easier access, the seatback may be reclined rearward.

Push the anchor connectors (D) on the high back booster seat into the lower anchors (C) in accordance with the instructions provided by the child restraint system's manufacturer.

After it is securely fastened, adjust the seatback to four steps forward from most reclined position.

**Remember, the lower anchors (C) provided with your vehicle are designed to secure suitable high back booster seats compatible with the LATCH system in the outboard positions of the rear seats only. The anchor connectors are NOT designed to secure a suitable high back booster seat in the middle seating position of the rear seat.**

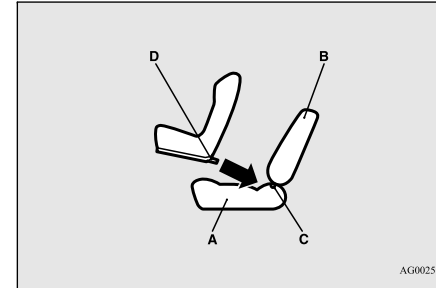

A- Vehicle seat cushion  
B- Vehicle seatback  
C- Lower anchor  
D- Connector

### ⚠ WARNING

- If there is any foreign material in or around the lower anchors, remove it before installing the high back booster seat. Also, make sure the seat belt is away from, not looped through or otherwise interfering with, the high back booster seat. If foreign matter is not removed and/or the seat belt interferes with the high back booster seat, the high back booster seat will not be secured properly, could detach and move forward in the event of sudden braking or an accident, and could result in injury to the child or other vehicle occupants.



Child restraint systems

4

**WARNING**

- When the vehicle is moving, do not adjust the seat where the high back booster seat is installed.

4. Latch the tether strap hook (E) of the high back booster seat to the tether anchor bar (F) and tighten the tether strap so it is securely fastened.

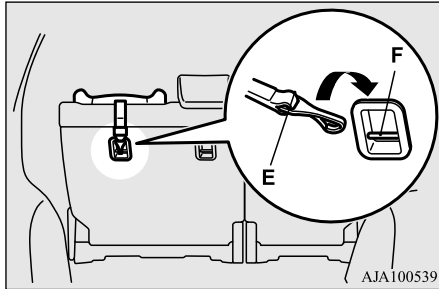

**NOTE**

- If it is difficult to latch the tether strap hook, turn the hook sideways.

**WARNING**

- Child restraint system tether anchors are designed only to withstand loads from correctly fitted child restraint systems. Under no circumstances are they to be used for adult seat belts, harnesses, for attaching other items, or equipment to the vehicle.

5. Before putting your child in the restraint, push and pull the high back booster seat in all directions to be sure it is firmly secure. Do this before each use. If the high back booster seat is not firmly secure, repeat steps 3 and 4.  
6. Sit the child in the high back booster seat. Fit the seat belt to the high back booster seat according to the child restraint system's manufacturer.

**WARNING**

- When using a child restraint in a rear seating position, always review the instructions provided with that restraint to make sure it is compatible with this vehicle and to understand how to properly install it. Child restraints, including booster seats, come in different sizes and configurations. Depending on where you place these child restraints, and depending on their size and configuration, you may not be able to access or properly use one or more adjacent seat belt assemblies. If this occurs, the adjacent seating position or positions should not be used. Failure to use a seat belt or improper use of a seat belt can result in serious injury or death should a crash occur.

**CAUTION**

- After removing the high back booster seat, install the head restraint.

## Child restraint systems

### ■ Booster cushion

#### ⚠ CAUTION

- Do not remove the head restraint when installing a booster cushion.

4

1. Open the gap a little between the seat cushion (A) and the seatback (B) with your hand to locate the lower anchors (C).
2. For easier access, the seatback may be reclined rearward.

Push the anchor connectors (D) on the booster cushion into the lower anchors (C) in accordance with the instructions provided by the child restraint system's manufacturer.

After it is securely fastened, adjust the seatback to four steps forward from most reclined position.

**Remember, the lower anchors (C) provided with your vehicle are designed to secure suitable booster cushions compatible with the LATCH system in the outboard positions of the rear seats only. The anchor connectors are NOT designed to secure a suitable booster cushion in the middle seating position of the rear seat.**

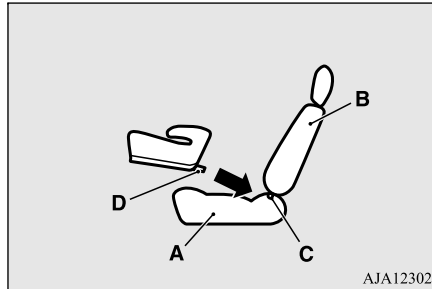

- A- Vehicle seat cushion
- B- Vehicle seatback
- C- Lower anchor
- D- Connector

#### ⚠ WARNING

- If there is any foreign material in or around the lower anchors, remove it before installing the booster cushion. Also, make sure the seat belt is away from, not looped through or otherwise interfering with, the booster cushion. If foreign matter is not removed and/or the seat belt interferes with the booster cushion, the booster cushion will not be secured properly, could detach and move forward in the event of sudden braking or an accident, and could result in injury to the child or other vehicle occupants.
- When the vehicle is moving, do not adjust the seat where the booster cushion is installed.

3. Sit the child in the booster cushion. Fit the seat belt to the booster cushion according to the child restraint system's manufacturer.

#### ⚠ WARNING

- When using a child restraint in a rear seating position, always review the instructions provided with that restraint to make sure it is compatible with this vehicle and to understand how to properly install it.  
Child restraints, including booster seats, come in different sizes and configurations. Depending on where you place these child restraints, and depending on their size and configuration, you may not be able to access or properly use one or more adjacent seat belt assemblies. If this occurs, the adjacent seating position or positions should not be used. Failure to use a seat belt or improper use of a seat belt can result in serious injury or death should a crash occur.

### Installing a child restraint system using the seat belt (with emergency/automatic locking mechanism)

N00407301609

With the exception of the driver, the seat belt in all other seating positions can be converted

from normal Emergency Locking Retractor (ELR) mode, to Automatic Locking Retractor (ALR) mode. This means that when you pull the seat belt fully out of the retractor, the retractor will switch to its ALR child restraint installation function. Always use the ALR child restraint installation function when you install a child restraint system using the seat belt.

Children 12 years old and under should always be restrained in the rear seat, whenever possible, although the front passenger seat belt can also be converted to ALR mode.

### **⚠ WARNING**

- When you install a child restraint system using the seat belt, always make sure the retractor has been switched to the ALR child restraint installation function. The ALR function will keep the child restraint system tightly secured to the seat. Failure to convert the retractor to the ALR function may allow the child restraint system to move forward during sudden braking or an accident, resulting in serious injury or death to the child or other occupants.

### **⚠ WARNING**

- When using a child restraint in a rear seating position, always review the instructions provided with that restraint to make sure it is compatible with this vehicle and to understand how to properly install it.

Child restraints, including booster seats, come in different sizes and configurations. Depending on where you place these child restraints, and depending on their size and configuration, you may not be able to access or properly use one or more adjacent seat belt assemblies. If this occurs, the adjacent seating position or positions should not be used. Failure to use a seat belt or improper use of a seat belt can result in serious injury or death should a crash occur.

## Installation

### Except for booster seat

1. Place the child restraint system on the seat where you wish to install it.  
To help assure proper fitting of the child restraint system, always remove the head restraint.  
When installing the front-facing child restraint system on the rear seat, adjust the angle of the rear seatback to the most upright position.

## Child restraint systems

2. Route the seat belt through the child restraint system according to the instructions provided by the child restraint system's manufacturer. Then insert the seat belt latch plate into the buckle. Make sure you hear a "click" when you insert the latch plate into the buckle.

**4**

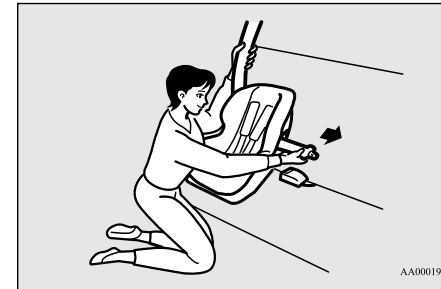

## Child restraint systems

3. To activate the ALR child restraint installation function, slowly pull the shoulder part of the belt all the way out of the retractor until it stops. Then let the belt feed back into the retractor.

**4**

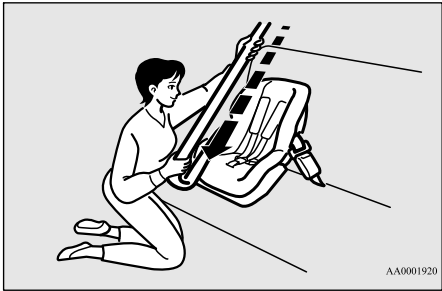

4. After the belt has retracted, tug on it. If the belt is in the ALR function, you will not be able to pull it out. If the webbing can be pulled out from retractor, the ALR function has not been activated and you will need to repeat steps 3 and 4.

5. After confirming that the belt is locked, grab the shoulder part of the belt near the buckle and pull up to remove any slack from the lap part of the belt allowing the slack to feed into the retractor. Remember, if the lap belt portion is not tight, the child restraint system will not be secure. It may help to put your weight on the child restraint system and/or push on its seat-back while pulling up on the belt (See illustration).

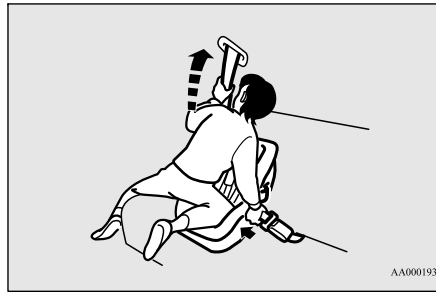

If your child restraint system requires the use of a tether strap, fasten the tether strap in accordance with the following procedures.

6. Latch the tether strap hook (A) of the child restraint system to the tether anchor bar (B) and tighten the tether strap so it is securely fastened.

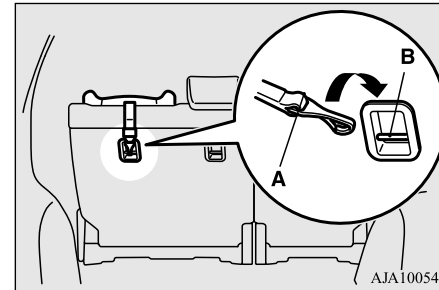

### NOTE

- If it is difficult to latch the tether strap hook, turn the hook sideways.

### WARNING

- Child restraint system tether anchors are designed only to withstand loads from correctly fitted child restraint systems. Under no circumstances are they to be used for adult seat belts, harnesses, for attaching other items, or equipment to the vehicle.

Child restraint systems

7. Before putting your child in the restraint, push and pull the restraint in all directions to be sure it is firmly secure. Do this before each use. If the child restraint system is not firmly secure, repeat steps 1 through 6.

**CAUTION**

- After removing the child restraint system, be sure to perform the following actions.
  - Wind up the seat belt completely to deactivate the ALR mode.
  - Install the head restraint.

**Booster seat**

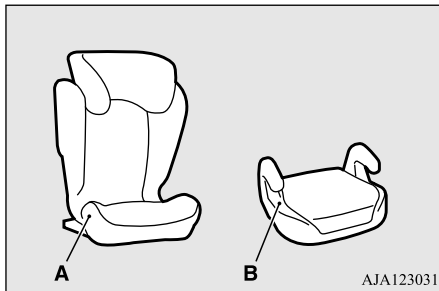

A- High back booster seat  
B- Booster cushion

**WARNING**

- To avoid injury to child, do not use the lap/shoulder belt Automatic Locking Retractor (ALR) child restraint installation function when using a booster seat with the seat belts.

**High back booster seat**

1. Place the high back booster seat on the seat where you wish to install it. To help assure proper fitting of the high back booster seat, always remove the head restraint.
2. If your high back booster seat requires the use of a tether strap, latch the tether strap hook (A) of the high back booster seat to the tether anchor bar (B) and tighten the tether strap so it is securely fastened.

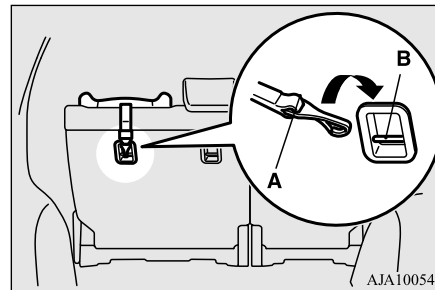

**NOTE**

- If it is difficult to latch the tether strap hook, turn the hook sideways.

**WARNING**

- Child restraint system tether anchors are designed only to withstand loads from correctly fitted child restraint systems. Under no circumstances are they to be used for adult seat belts, harnesses, for attaching other items, or equipment to the vehicle.

4

3. Sit the child in the high back booster seat. Fit the seat belt to the high back booster seat according to the child restraint system's manufacturer.

**CAUTION**

- After removing the high back booster seat, install the head restraint.

**Booster cushion**

**CAUTION**

- Do not remove the head restraint when installing a booster cushion.

1. Place the booster cushion on the seat where you wish to install it.

## Maintenance and inspection of seat belts

- Sit the child in the booster cushion. Fit the seat belt to the booster cushion according to the child restraint system's manufacturer.

### 4 Children who have outgrown child restraint systems

N00407601628

Children who have outgrown a child restraint system should be seated in the rear seat and wear the seat belt. If the shoulder belt crosses their face or neck, and/or the lap belt crosses their stomach, a commercially available booster seat must be used to raise the child so that the shoulder belt crosses their shoulder and the lap belt remains positioned low across their hips. The booster seat should fit the vehicle seat and have a label certifying compliance with Federal Motor Vehicle Safety Standards or Motor Vehicle Restraint Systems and Booster Seats Safety Regulations.

#### WARNING

- Any child who is too small to properly wear a seat belt must be properly restrained in an appropriate child restraint system, to reduce their risk of serious injury or death in an accident.

#### WARNING

- A child should never be left unattended in, or unsupervised around, your vehicle. When you leave the vehicle, always take the child out as well.
- Children can die from heat stroke if left or trapped inside the vehicle, especially on hot days.
- Keep your vehicle locked when not in use. Keep your vehicle keys away from children.

### Maintenance and inspection of seat belts

N00407001361

Regularly check your seat belt buckles and their release mechanisms for positive engagement and release of the latch plate. Check the retractors for automatic locking when in the Automatic Locking Retractor function.

The entire seat belt assembly should be replaced if the webbing shows any obvious cuts, tears, increase in thickness in any section of the webbing from broken fibers, or severe fading from sunlight. All of these conditions indicate a weakening of the belt, which may adversely affect seat belt performance in an accident.

#### WARNING

- Do not attempt to repair or replace any part of the seat belt assemblies. This work should be done by a certified Mitsubishi EV dealer. Failure to have a certified Mitsubishi EV dealer perform the work could reduce the effectiveness of the belts and could result in a serious injury or death in an accident.
- Never use an organic solvent to clean the seat belt webbing. Do not attempt to bleach or re-dye the seat belt webbing. These may weaken the seat belt webbing, increasing risk of injury or death in an accident.
- Clean seat belt webbing only with mild soap or detergent solution and rinse it with lukewarm water, and dry the seat belt webbing completely before retracting it.

### Supplemental Restraint System (SRS) - airbag

N00407701847

This vehicle is equipped with a Supplemental Restraint System (SRS), which includes airbags for the driver and passengers.

The SRS front airbags are designed to supplement the primary protection of the driver and front passenger seat belt systems by providing those occupants with protection against

## Supplemental Restraint System (SRS) - airbag

head and chest injuries in certain moderate to severe frontal collisions. The SRS front airbags, together with sensors at the front of the vehicle and sensors attached to the front seats, form an advanced airbag system.

The SRS driver's knee airbag is designed to supplement the primary protection of the driver's seat belt system. It can reduce the forward movement of the driver's lower legs and provide increased overall body protection in certain moderate to severe frontal collisions.

The SRS side airbags and the curtain airbags are also designed to supplement the seat belts. The SRS side airbags provide the driver and front passenger with protection against chest injuries by deploying the bag on the side impacted in moderate to severe side impact collisions. The SRS curtain airbags provide the driver and the passengers on the front seat and the rear outboard seats with protection against head injuries by deploying the curtain airbag on the side impacted in moderate to severe side impact collisions and by deploying both curtain airbags when a rollover is detected. The curtain airbags are also designed to help reduce the risk of complete and partial ejection from the vehicle through side windows in both side impact and rollover type accidents.

The SRS airbags are NOT a substitute for use of the seat belts. For maximum protection in all types of accidents, seat belts must ALWAYS be worn by everyone who drives or rides in this vehicle (with infants and small children in an appropriate child restraint system in the rear seat, and older children buckled in the rear seat). Refer to "Child restraint systems" on page 4-24.

**WARNING**

● **IT IS VERY IMPORTANT TO ALWAYS WEAR YOUR SEAT BELT PROPERLY EVEN WITH AN AIRBAG.**

• **Seat belts help keep the driver and passengers properly positioned. This reduces the risk of injury in all collisions, and reduces the risk of serious injuries or death when the airbags inflate.**

**During sudden braking just before a collision, an unrestrained or improperly restrained driver or front passenger can move forward into direct contact with, or within close proximity to, the airbag when it begins to inflate.**

**The beginning stage of airbag inflation is the most forceful and can cause serious injuries or death if the occupant comes in contact with the airbag at this time.**

• **Seat belts reduce the risk of injury in rear impact collisions, and in lower-speed frontal collisions because the airbags are not designed to inflate in those situations.**

• **Seat belts reduce the risk of being thrown from your vehicle in a collision or rollover.**

## Supplemental Restraint System (SRS) - airbag

4

### **⚠ WARNING**

- **IT IS VERY IMPORTANT TO BE PROPERLY SEATED.**
- A driver or front passenger sitting too close to the steering wheel or instrument panel during airbag deployment can be seriously injured or killed.
- Airbags inflate very quickly and with great force. If the driver and front passenger are not properly seated and restrained, the airbag may not provide the proper protection, and can cause serious injuries or death when it inflates.
- To reduce the risk to the driver of serious injury or death due to a deploying driver's airbag, always properly wear your seat belt and adjust the driver's seat as far back as possible, maintaining a position that still allows the driver to have good control of the steering wheel, brake, accelerator, and other vehicle controls.
- To reduce the risk to the front passenger of serious injury or death from a deploying passenger's airbag, make sure the passenger always wears the seat belt properly, remains seated upright and all the way back in the seat, and positions the seat as far back as possible.
- Seat all infants and children in the rear seat, properly restrained in an appropriate child restraint system.

### **⚠ WARNING**

- Airbags inflate very quickly and with great force. Do not sit on the edge of the seat or sit with your lower legs too close to the instrument panel, or lean your head or chest close to the steering wheel or the instrument panel.
- Do not put your feet or legs on or against the instrument panel.

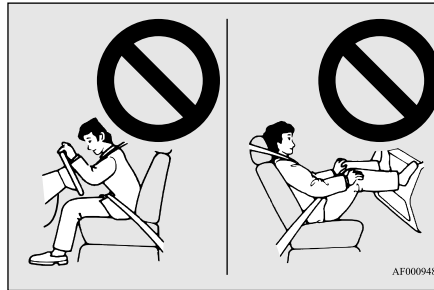

### **⚠ WARNING**

- Infants and small children should never ride unrestrained, or lean against the instrument panel. They should never ride held in your arms or on your lap. They can be seriously injured or killed in an accident, especially when the airbags inflate. Seat all infants and children in the rear seat, properly restrained in an appropriate child restraint system. Refer to "Child restraint systems" on page 4-24.

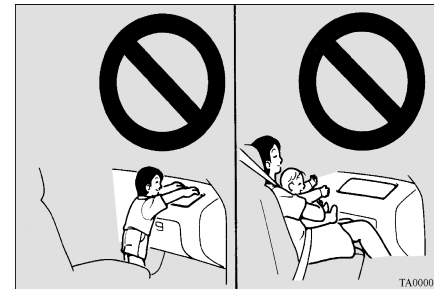



## Supplemental Restraint System (SRS) - airbag

### **⚠ WARNING**

● NEVER put REAR-FACING CHILD RESTRAINT SYSTEMS or INFANT RESTRAINT SYSTEMS in the front passenger seat. This places the infant too close to the passenger's airbag. During deployment of that airbag, the infant can be seriously injured or killed. Rear-facing child restraint systems or infant restraint systems must only be used in the rear seat.

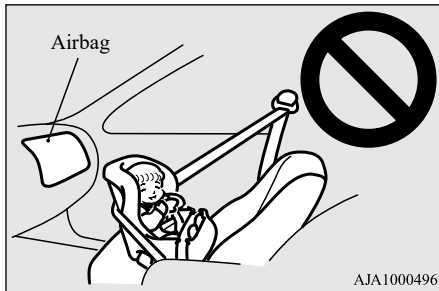

### **⚠ WARNING**

● FRONT-FACING CHILD RESTRAINT SYSTEMS should be used in the rear seat whenever possible. If they must be used in the front passenger seat, move the seat to the most rearward position and make sure the child stays in the child restraint system, properly restrained. Failure to follow these instructions could result in serious injury or death to the child.



### **⚠ WARNING**

● Older children should be seated in the rear seat with their seat belt properly worn, and with an appropriate booster seat if needed. Refer to "Children who have outgrown child restraint systems" on page 4-36.

### **How the Supplemental Restraint System works**

N00407801675

The SRS includes the following components:

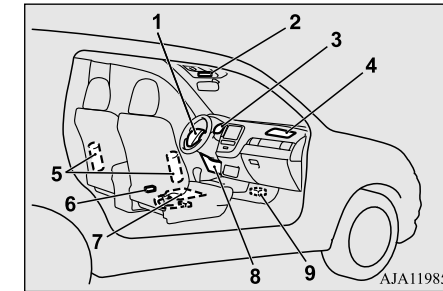

- 1- Airbag module (Driver)
- 2- Passenger's airbag off indicator
- 3- SRS warning light
- 4- Airbag module (Passenger)
- 5- Side airbag modules
- 6- Driver's seat position sensor
- 7- Passenger's seat occupant classification sensor system
- 8- Airbag module (Driver's knee)
- 9- Airbag control unit

4

## Supplemental Restraint System (SRS) - airbag

4

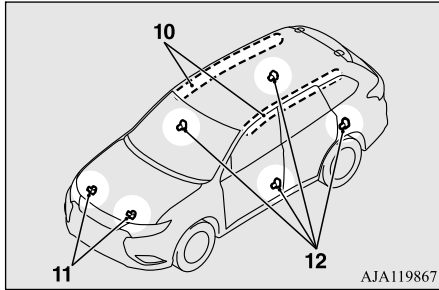

- 10- Curtain airbag modules
- 11- Front impact sensors
- 12- Side impact sensors

The airbag control unit monitors the readiness of the electronic parts of the system whenever the operation mode of the power switch is in ON. These include all of the items listed above and all related wiring.

The airbags will operate under the same conditions as the airbag control unit.

When the impact sensors detect a sufficient front or side impact to deploy the airbag(s), the appropriate airbag(s) will be deployed.

When the airbag control unit detects rollover of the vehicle, curtain airbags will be deployed.

When airbags deploy, some smoke is released accompanied by a loud noise. The smoke is not harmful, but do not intentionally inhale the smoke as it may cause temporary irritation to people with respiratory problems.

An inflated airbag will deflate quickly, so you may not even notice that the airbag was inflated.

Airbag inflation does not prevent the driver from seeing or being able to steer the vehicle, and does not prevent people from leaving the vehicle.

### CAUTION

- Airbags inflate very quickly and with great force. In certain situations, contact with an inflating airbag may cause small cuts, abrasions, and bruises.

### Driver's seat position sensor

N00417901220

The driver's seat position sensor is attached to the seat rail and provides the airbag control unit with information on the seat's fore-aft position. The airbag control unit controls deployment of the driver's front airbag in accordance with the information it receives from this sensor.

If there is a problem involving the driver's seat position sensor, the SRS warning light in

the instrument panel will come on. Refer to "SRS warning light/display" on page 4-42.

### WARNING

- If the SRS warning light or warning display comes on, have the vehicle inspected by a certified Mitsubishi EV dealer as soon as possible.
- Please observe the following instructions to ensure that the driver's seat position sensor can operate correctly.
  - Adjust the seat to the correct position, and sit well back against the seatback. Refer to "Front seats" on page 4-4.
  - Do not recline the seatback more than necessary when driving.
  - Do not place metallic objects or luggage under the front seat.
- If the vehicle is involved in a severe impact, have the SRS sensors inspected by a certified Mitsubishi EV dealer as soon as possible.

### Passenger's seat occupant classification sensor system

N00418001390

The passenger's seat occupant classification sensor system is attached to the front passenger seat cushion and provides the airbag control unit with information regarding the occupant on the front passenger seat. The air-

## Supplemental Restraint System (SRS) - airbag

bag control unit controls deployment of the passenger's front airbag in accordance with the information it receives from this system. The passenger's front airbag will not deploy in an impact when the system senses no occupant on the front passenger's seat or a child in a child restraint system. In this case, the passenger airbag off indicator will come on. Refer to "Passenger's airbag off indicator" on page 4-41.

If there is a problem involving the passenger's seat occupant classification sensor system, the SRS warning light in the instrument panel will come on. Refer to "SRS warning light/display" on page 4-42.

**WARNING**

- If any of the following conditions occur, you should immediately have your vehicle inspected by a certified Mitsubishi EV dealer as soon as possible:
  - The SRS warning light does not initially come on when the operation mode of the power switch is in ON.
  - The SRS warning light does not go out after several seconds.
  - The SRS warning light comes on while you are driving.

**WARNING**

- To ensure that the passenger's seat occupant classification sensor system can sense correctly, observe the following instructions. Failure to follow these instructions can adversely affect the performance of the passenger's airbag system.
  - Adjust the seat to the correct position, and sit well back against the seatback. Refer to "Front seats" on page 4-4.
  - Do not recline the seatback more than necessary.
  - Never have more than one person (adult or child) sitting on the seat.
  - Do not place anything between the seat and the floor console.
  - When attaching a child restraint system, secure it firmly.
  - Do not place luggage or other objects on the seat.
  - Do not use a seat cover or a cushion.
  - Do not modify or replace the seat and seat belt.
  - Do not place luggage or other objects under the seat.
  - Do not place and use an electronic device such as a computer on the seat.
  - Do not place heavy objects on the seat or stick pins, needles, or other objects into it.
  - Do not remove the seat cushion skin.
  - If any liquid is spilled on the seat, wipe it and dry the seat immediately.

**WARNING**

- If the vehicle is involved in a severe impact, have the SRS sensors inspected by a certified Mitsubishi EV dealer as soon as possible.

**4****Passenger's airbag off indicator**

N00418101418

The passenger's airbag off indicator is located as shown in the illustration.

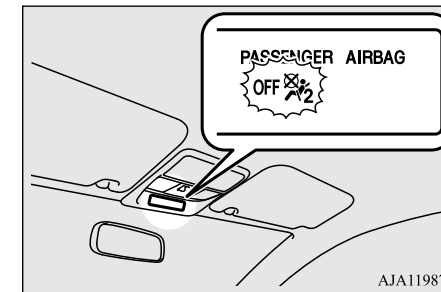

The indicator normally comes on when the operation mode is put in ON, and goes out a few seconds later. In the following situations, the indicator will stay on to show that the passenger front airbag is not operational.

- The front passenger's seat is not occupied.
- The system senses that a child is using a child restraint system on the front passenger's seat.

## Supplemental Restraint System (SRS) - airbag

When the passenger's seat occupant classification sensor system sense there is a person seated in the front passenger's seat, the indicator goes out to show that the passenger's front airbag is operational.

4

### ⚠ WARNING

- If any of the following conditions occur, you should immediately have the airbag system in your vehicle inspected by a certified Mitsubishi EV dealer as soon as possible:
  - The passenger's airbag off indicator comes on when an adult is sitting on the front passenger seat.
  - The passenger's airbag off indicator does not come on when the front passenger seat is not occupied.
  - The passenger's airbag off indicator does not come on when the operation mode is put in ON.
  - The passenger's airbag off indicator does not come on when a child is in a child restraint system on the front passenger's seat.
  - The passenger's airbag off indicator comes on and goes out repeatedly.
- Do not attach any accessory to your vehicle that makes the passenger's airbag off indicator difficult or impossible to see. You must be able to see the passenger's airbag off indicator and verify the status of the passenger's airbag system.

### SRS warning light/display

N00408301664

There is a Supplemental Restraint System (SRS) warning light on the instrument panel.



The system checks itself every time the operation mode of the power switch is put in ON. The SRS warning light will come on for several seconds and then go out. This is normal and means the system is working properly. If there is a problem involving one or more of the SRS components, the warning light will come on and stay on. At the same time, the warning display will appear on the information screen in the multi-information display. The SRS warning light/display is shared by the SRS airbag and the seat belt pre-tensioner system.

### ⚠ WARNING

- If any of the following conditions occur, there may be a problem with the SRS airbags and/or seat belt pre-tensioners, and they may not function properly in a collision or may suddenly activate without a collision:
    - Even when the operation mode is in ON, the SRS warning light does not come on or it remains on.
    - The SRS warning light and/or the warning display comes on while driving.
- The SRS airbags and seat belt pre-tensioners are designed to help reduce the risk of serious injury or death in certain collisions. If either of the above conditions occurs, immediately have your vehicle checked by a certified Mitsubishi EV dealer.

### Driver's and passenger's front airbag system

N00407901331

The driver's airbag is located under the padded cover in the middle of the steering wheel. The front passenger's airbag is contained in the instrument panel above the glove compartment. The driver's airbag and the front passenger's airbag are designed to deploy at the same time. However, the front passenger's airbag does not deploy when the front

## Supplemental Restraint System (SRS) - airbag

passenger seat is not occupied or when the system senses that a child is in the child restraint system.

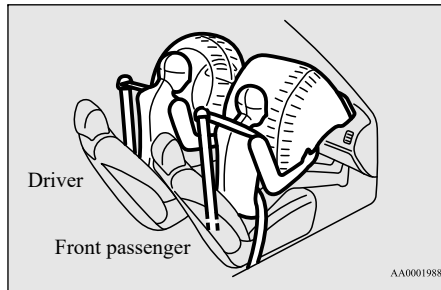

4

### Driver's knee airbag system

N00404500010

The driver's knee airbag is located under the steering wheel. The driver's knee airbag is designed to deploy at the same time as the driver's front airbag.

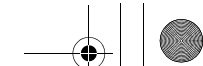

## Supplemental Restraint System (SRS) - airbag

### Deployment of front airbags

N00408001645

#### The front airbags and driver's knee airbag ARE DESIGNED TO DEPLOY when ...

4

Head-on collision with a solid wall at speeds of approx. 15 mph (25 km/h) or higher

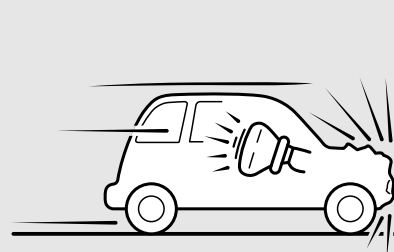

Moderate to severe frontal impact within the shaded area between the arrows

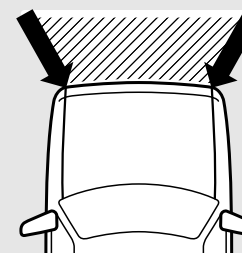

AA1000050

The front airbags and driver's knee airbag are designed to deploy when the vehicle suffers a moderate to severe frontal impact. A typical condition is shown in the illustration to the left.

The front airbags and driver's knee airbag are designed to deploy only in certain moderate to severe frontal collisions within the shaded area between the arrows in the illustration to the right.

The front airbags and driver's knee airbag will deploy if the impact to the vehicle's main structure is above a specific threshold level. The threshold level is approximately 15 mph (25 km/h) for a frontal collision straight into a solid flat wall that does not bend or deform. If the impact to the vehicle's main structure is below this threshold level, the front airbags and driver's knee airbag may not deploy. This threshold level may also be higher if the vehicle hits something that absorbs the impact, either by bending or moving (for example,

another stationary vehicle, a pole or a guard rail).

The initial stage of airbag inflation is the most forceful, and can cause serious injury or death if you are too close to the deploying airbag. Accordingly, it is important that you always wear the available seat belt.

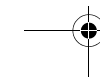
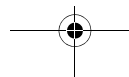

## Supplemental Restraint System (SRS) - airbag

### The front airbags and driver's knee airbag **MAY NOT DEPLOY** when ...

In certain types of front collisions, the front airbags and driver's knee airbag may not deploy, even if the deformation of the body seems to be large, because the vehicle's body structure is designed to absorb the impact and deform in order to help protect the occupants. Some typical situations where the front airbags and driver's knee airbag may not deploy are shown in the illustrations.

Since the front airbags and driver's knee airbag do not protect the occupant in all types of frontal collisions, be sure to always wear your seat belts properly.

Collision with a utility pole, tree or other narrow object

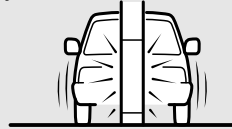

Collision where the vehicle slides under the rear body of a truck

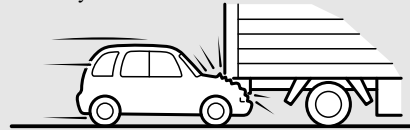

Oblique frontal impact

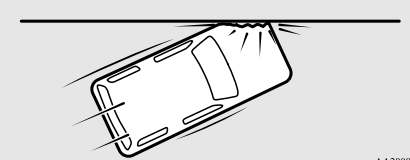

AA2000233

### The front airbags and driver's knee airbag **ARE NOT DESIGNED TO DEPLOY** when ...

The front airbags and driver's knee airbag are not designed to deploy in situations where

they cannot provide protection to the occupants. Some typical situations are shown in the illustration.

Since the front airbags and driver's knee airbag do not protect the occupants in all types of collisions, be sure to always wear your seat belts properly.

4

Rear end collision to your vehicle



Side collision to your vehicle

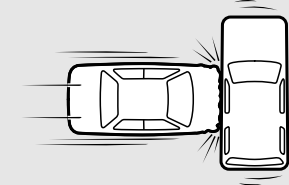

Vehicle rolls onto its side or roof



AA2000220

## Supplemental Restraint System (SRS) - airbag

### The front airbags and driver's knee airbag **MAY DEPLOY** when ...

**4** The front airbags and driver's knee airbag may deploy if the underside of the vehicle suffers a moderate to severe impact (under-carriage impact). Some typical situations are shown in the illustration.

Since the front airbags and driver's knee airbag may deploy in certain types of unexpected impacts, as shown in the illustrations, and these unexpected impacts can move you out of position, it is important to always wear your seat belts properly. When worn properly, seat belts can help maintain your distance from the airbags when they begin to inflate. The initial stage of airbag inflation is the most forceful and can cause serious injury or death if you are close to the deploying airbag.

Collision with an elevated median/island or curb



Vehicle travels over a deep hole/pothole



Vehicle drives down a steep slope and hits the ground

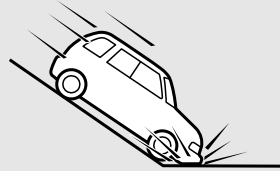

AA2000073

### **WARNING**

- Do not attach anything to the steering wheel's padded cover, such as trim material, badges, etc. These could strike and injure an occupant if the airbag inflates.
- Do not set anything on, or attach anything to, the instrument panel above the glove compartment. Such items could strike and injure an occupant if the airbag inflates.

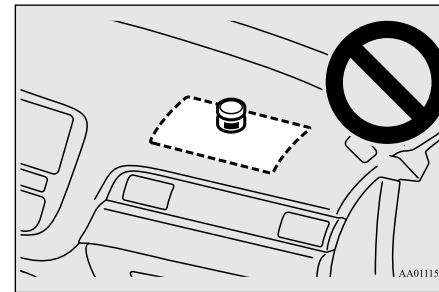

### **WARNING**

- Do not attach accessories to, or put them in front of, the windshield. They could restrict the airbag inflation, or strike and injure an occupant, when the airbag inflates.



## Supplemental Restraint System (SRS) - airbag

### ⚠ WARNING

- Do not attach accessories to the lower portion of the driver's side instrument panel. Such objects could prevent the driver's knee airbag from inflating normally or could be propelled to cause serious injury if the airbag inflates.

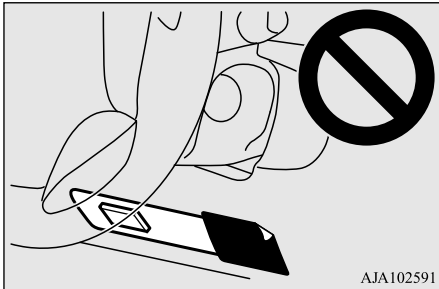

### ⚠ WARNING

- Do not attempt to remove, install, disassemble or repair the SRS airbags.
- Do not place objects, such as packages or pets, between the airbags and the driver or the front passenger. Such objects can adversely affect airbag performance, or cause serious injury or death when the airbag deploys.
- Immediately after airbag inflation, some parts of the airbag system will be hot. Do not touch them. You could otherwise be burned.

### ⚠ WARNING

- The airbag system is designed to work only once. After the airbags deploy, they will not work again. They must promptly be replaced and the entire airbag system must be inspected by a certified Mitsubishi EV dealer.

### Side airbag system

N00408101431

The side airbags (A) are contained in the driver and front passenger seatbacks. The side airbag is designed to inflate only on the side of the vehicle that is impacted, even with no passenger in the front seat.

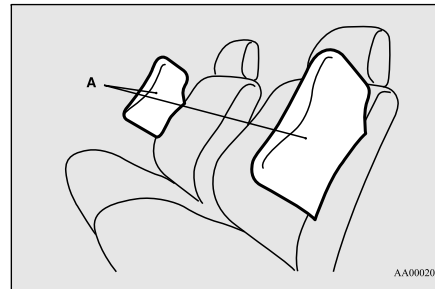

A label is attached to the seatbacks in vehicles equipped with side airbags.

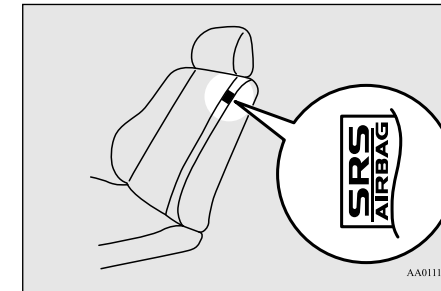

4

## Supplemental Restraint System (SRS) - airbag

### Curtain airbag system

N00419201298

The curtain airbags are contained in the front pillar, the rear pillar and the side sections of the roof.

- 4** The curtain airbag is designed to inflate only on the side of the vehicle that is impacted, even with no passenger in the seat. Also, when the airbag control unit detects rollover of the vehicle, the curtain airbags will deploy.

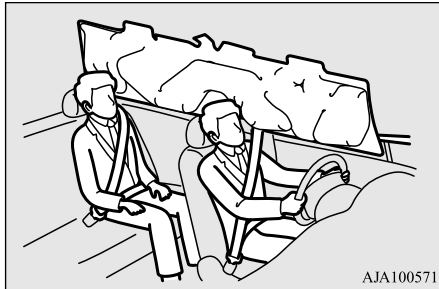

### ⚠ WARNING

- The side airbags and curtain airbags can cause serious injury or death to anyone too close to the airbag when it deploys. To reduce the risk of injury from a deploying side airbag or curtain airbag, driver and front passenger must be properly restrained and seated well back, upright, and in the middle of the seat. Do not lean against the door.



### ⚠ WARNING

- In order to reduce the risk of injury from a deploying side airbag, do not allow any rear seat passengers to hold onto the back of either front seat. Special care should be taken with children.

### ⚠ WARNING

- Do not place any objects around the area where the side airbags deploy. Such objects can interfere with proper side airbag deployment, and cause injury during deployment of the side airbag.
- Do not place stickers, labels or additional trim on the back of either front seat. They can interfere with proper side airbag deployment.
- Do not attach a microphone (A) or any other object around the part where the curtain airbag (B) deploys, such as on the windshield, side door glass or front and rear pillars and roof side rail. When the curtain airbag inflates, the microphone or other object may be hurled with great force or the curtain airbag may not inflate correctly, resulting in death or serious injury.

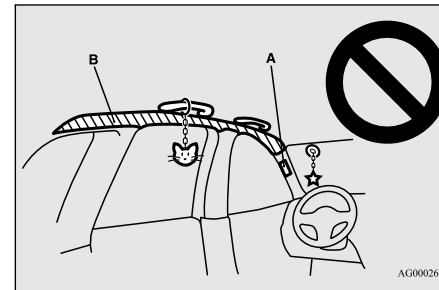

Supplemental Restraint System (SRS) - airbag

**⚠ WARNING**

- Do not put a hanger or any heavy or pointed object on the coat hook. If the curtain airbag was activated, any such item could be propelled away with great force and could prevent the curtain airbag from inflating correctly. Hang clothes directly on the coat hook (without using a hanger). Make sure there are no heavy or sharp objects in the pockets of clothes that you hang on the coat hook.
- Do not install seat covers or re-cover seats that have side airbags. Covers can interfere with proper side airbag deployment and adversely affect side airbag performance.
- Never install a rear-facing child restraint system in the front passenger seat. Rear-facing child restraint systems **MUST ONLY** be used in the rear seat.
- Front-facing child restraint systems should also be used **ONLY** in the rear seat. If a front-facing child restraint system must be used in the front passenger seat, move the seat as far back as possible, and make sure that the child stays in the child restraint system, properly restrained and away from the door.

**⚠ WARNING**

- Do not allow a child to lean against or sit close to the passenger door, even if the child is seated in a child restraint system. The child's head should also not lean against or be close to the section of the seatback where the side airbag and curtain airbag are located. It is dangerous if the side airbag or curtain airbag deploys. Failure to follow all of these instructions could lead to serious injury or death to the child.
- Work done on or in the vicinity of the side airbag or curtain airbag components should be done only by a certified Mitsubishi EV dealer. There is a risk of a serious injury or death. Improper work methods can cause accidental side airbag or curtain airbag deployment, or render a side airbag or curtain airbag inoperable. Either of these situations could result in serious injury or death.

**Deployment of side airbag and curtain airbag**

N00408201591

**The side airbag and curtain airbag ARE DESIGNED TO DEPLOY when...**

**4**

The side airbag and curtain airbag are designed to deploy when the vehicle suffers a moderate to severe side impact to the middle of the passenger compartment. Also when the vehicle detects rollover of the vehicle, the curtain airbags will deploy. Typical situations are shown in the illustration.

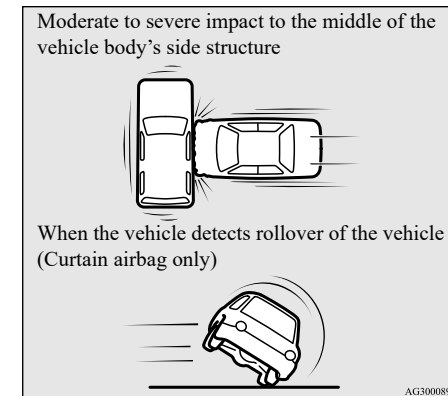

## Supplemental Restraint System (SRS) - airbag

The seat belts in your vehicle are your primary means of protection in an accident. The SRS side airbags and curtain airbags are designed to provide additional protection. Therefore, for your safety and the safety of all occupants, be sure to always wear your seat belts properly.

**4**

### The side airbag and curtain airbag MAY NOT DEPLOY when...

In certain types of side collisions, the side airbag and curtain airbag may not deploy, even if the deformation of the body seems to be large, because the vehicle's body structure is designed to absorb the impact and to deform in order to help protect the occupants. There are also cases where the side airbag and curtain airbag may not deploy at the same time, depending on the location of the impact. Some typical situations where the side airbags and curtain airbags may not deploy are shown in the illustrations.

Since the side airbags and curtain airbags do not protect the occupant in all types of side collisions, be sure to always wear the seat belts properly.

Side impact in an area away from the passenger compartment

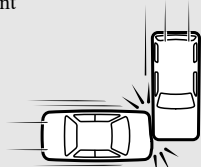

Motorcycle or other similar small vehicle collision with the side of vehicle



Collision with a utility pole, tree or other narrow object

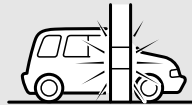

AA2000246

Oblique side impact



Vehicle rolls onto its side or roof (Side airbag only)



AA3000461

### The side airbag and curtain airbag ARE NOT DESIGNED TO DEPLOY when...

The side airbag and curtain airbag are not designed to deploy in situations where they cannot provide protection to the occupants. Some typical situations are shown in the illustration.

## Supplemental Restraint System (SRS) - airbag

Since the side airbags and curtain airbags do not protect the occupant in all types of collisions, be sure to always wear your seat belts properly.

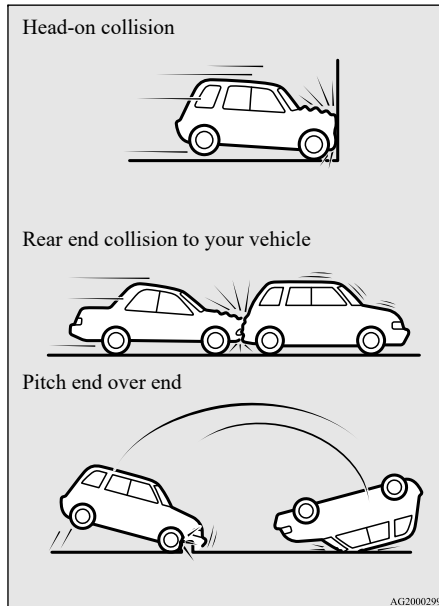

### SRS servicing

N00408501855

#### ⚠ WARNING

- Any maintenance performed on or near the components of the SRS should be performed only by a certified Mitsubishi EV dealer. Do not permit anyone else to do any service, inspection, maintenance or repair on any SRS components or wiring. Similarly, no part of the SRS should ever be handled, removed or disposed by anyone except a certified Mitsubishi EV dealer.

Improper work methods on the SRS components or wiring could result in an accidental airbag deployment or could make the SRS inoperable. Either of these situations could result in serious injury or death.

- Do not modify your steering wheel or any other SRS component or related vehicle part. For example, replacement of the steering wheel, or modifications to the front bumper or body structure can adversely affect SRS performance and may lead to injury.
- If your vehicle has received any damage, you should have the SRS inspected by a certified Mitsubishi EV dealer to make sure it is in proper working order.

#### ⚠ WARNING

- Do not modify your front seats, center pillar or center console. Such modifications can adversely affect SRS performance and may lead to injury. Also, if you discover any tear or open seam in the seat fabric near the side airbag, have the seat inspected by a certified Mitsubishi EV dealer.
- If you have found any scratch, crack or damage to the portion of the front and rear pillars and roof side rail, you should have the SRS inspected by a certified Mitsubishi EV dealer.

#### 📖 NOTE

- When you transfer ownership of the vehicle to another person, we urge you to alert the new owner that it is equipped with the SRS and refer that owner to the applicable sections in this owner's manual.
- If you decide to junk or scrap your vehicle, we urge you to first take it to a certified Mitsubishi EV dealer so that the SRS can be made safe for disposal.
- If any of the following parts needs to be modified for use by a handicapped person, the advanced airbag system will be greatly affected. Please consult a certified Mitsubishi EV dealer.
  - Driver's seat
  - Front passenger seat
  - Front seat belt

## Supplemental Restraint System (SRS) - airbag

### NOTE

- Steering wheel
- Instrument panel

**4**

#### [For vehicles sold in U.S.A.]

To contact Mitsubishi Motors North America, Inc.  
call 1-888-648-7820 or write to:  
**Mitsubishi Motors North America, Inc.**  
**Customer Relations Department**  
**P.O. Box 689040**  
**Franklin, TN 37068**

#### [For vehicles sold in Canada]

To contact Mitsubishi Motor Sales of Canada, Inc.  
call 1-888-576-4878 or write to:  
**Mitsubishi Motor Sales of Canada, Inc.**  
**Customer Relations Department**  
**P.O. Box 41009**  
**4141 Dixie Road**  
**Mississauga, ON L4W 5C9**

#### [For vehicles sold in Puerto Rico]

To contact Mitsubishi Motor Sales of Caribbean, Inc.  
call 1-787-251-8715 or write to:  
**Mitsubishi Motor Sales of Caribbean, Inc.**  
**Customer Service Department**  
**P.O. Box 192216**  
**SAN JUAN PR 00919-2216**

## Warning label

N00408600354

Occupant restraint warning labels for the SRS are located in the vehicle as shown in the illustration.

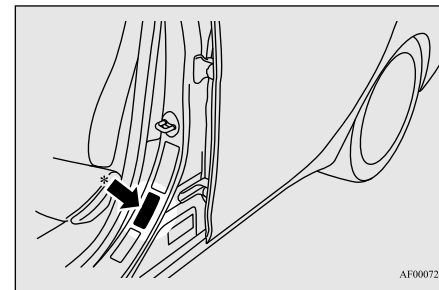
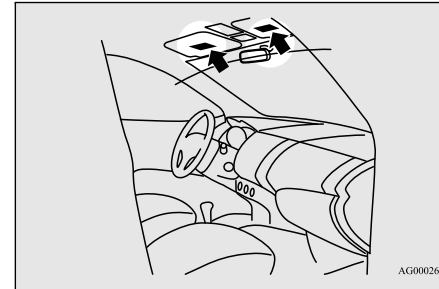

\* - Located in the passenger's side as well.

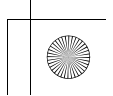
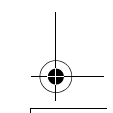
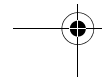
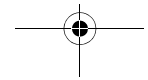
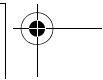
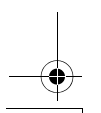
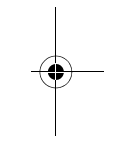
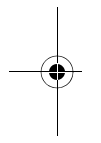
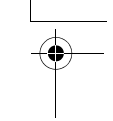
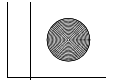
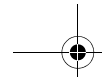
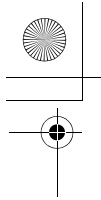

Handwriting practice area consisting of 10 horizontal dashed lines.

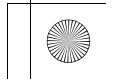
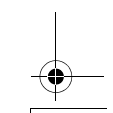
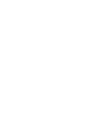
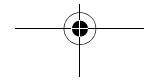
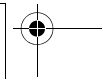
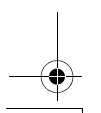
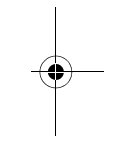
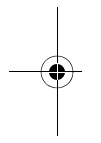
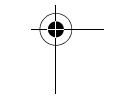
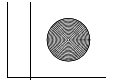
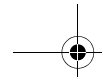
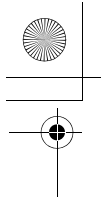



## Features and controls

Break-in recommendations .....	5-3	Hill start assist .....	5-77
Keys .....	5-3	Brake assist system .....	5-78
Free-hand Advanced Security Transmitter (F.A.S.T.-key) .....	5-4	Anti-lock braking system (ABS) .....	5-78
Door locks .....	5-24	Electric power steering system (EPS) .....	5-80
Power door locks .....	5-26	Active stability control (ASC) .....	5-81
Child safety locks for rear door .....	5-28	Cruise control (if so equipped) .....	5-84
Liftgate (except for vehicles equipped with the power liftgate) ....	5-28	Adaptive Cruise Control System (ACC) (if so equipped) .....	5-88
Power liftgate (if so equipped) .....	5-30	Forward Collision Mitigation System (FCM) (if so equipped) ....	5-100
Inside liftgate release .....	5-36	Blind Spot Warning (BSW) (with Lane Change Assist) (if so equipped) .....	5-109
Theft-alarm system .....	5-37	Rear Cross Traffic Alert (RCTA) (if so equipped) .....	5-114
Power window control .....	5-40	Lane Departure Warning System (LDW) (if so equipped) .....	5-118
Sunroof (if so equipped) .....	5-43	Tire pressure monitoring system (TPMS) .....	5-122
Parking brake .....	5-45	Rear-view camera (if so equipped) .....	5-126
Steering wheel height and reach adjustment .....	5-49	Multi Around Monitor (if so equipped) .....	5-128
Inside rearview mirror .....	5-49	Instrument cluster .....	5-137
Outside rearview mirrors .....	5-52	Multi-information display .....	5-140
Electrical parking switch .....	5-55	Indicator light, warning light, and information screen display list .....	5-160
Selector Lever (Joystick type) .....	5-56	Indicators .....	5-186
S-AWC (Super-All Wheel Control) (if so equipped) .....	5-61	Warning lights .....	5-187
4-wheel drive operation .....	5-63	Information screen display .....	5-189
Inspection and maintenance following rough road operation .....	5-65	Combination headlights and dimmer switch .....	5-190
Cautions on the handling of 4-wheel drive vehicles .....	5-65	Turn signal lever .....	5-198
EV switch .....	5-66	Hazard warning flasher switch .....	5-198
SAVE/CHARGE mode switch .....	5-68	ECO mode switch .....	5-199
SPORT mode switch .....	5-71	Front fog light switch .....	5-199
Acoustic vehicle alerting system (AVAS) .....	5-72	Wiper and washer switch .....	5-200
Service brake .....	5-73		
Brake auto hold .....	5-74		

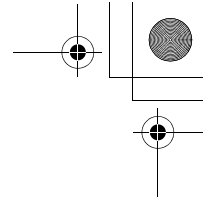
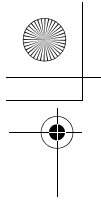

# Features and controls

## 5

- Wiper deicer switch (if so equipped)..... 5-204
- Electric rear window defogger switch ..... 5-204
- Heated steering wheel switch (if so equipped)..... 5-205
- Horn switch ..... 5-206
- Link System ..... 5-206
- USB input terminal ..... 5-207
- Sun visors ..... 5-208
- 12 V power outlets ..... 5-209
- USB port (for charging) (if so equipped) ..... 5-210
- 120 V AC power supplies (if so equipped)..... 5-211
- HomeLink® Wireless Control System (if so equipped) ..... 5-214
- Interior lights ..... 5-220
- Storage spaces ..... 5-223
- Cup holders ..... 5-226
- Bottle holders ..... 5-226
- Cargo area cover (if so equipped) ..... 5-227
- Assist grips ..... 5-228
- Coat hooks ..... 5-229
- Luggage hooks ..... 5-229

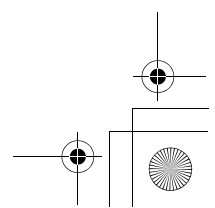
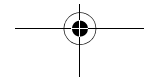
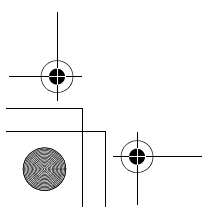
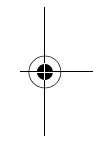
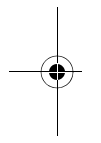

Break-in recommendations

**Break-in recommendations**

N00508701379

Advanced automobile manufacturing techniques permit you to operate your new vehicle without requiring a long break-in period of low-speed driving.

However, you can add to the future performance and economy of your vehicle by observing the following precautions during the first 300 miles (500 km).

Drive your vehicle at moderate speeds during the break-in period.

- Do not overload the vehicle. Stay within the seating capacity. (Refer to “Cargo load precautions” on page 6-11.)
- Refrain from towing a trailer or other vehicle (Refer to “Trailer towing” on page 6-13).

**Keys**

N00508801817

Two F.A.S.T.-keys and two emergency keys are provided.

Keep one F.A.S.T.-key and one emergency key in a safe place together as a set of spare keys.

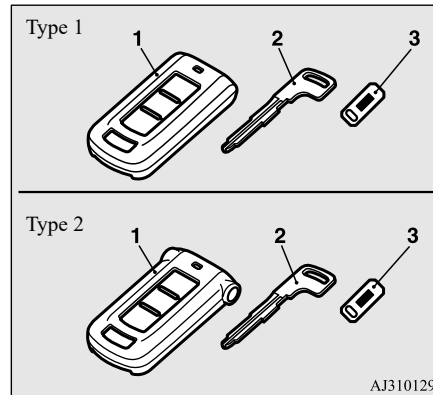

- 1- F.A.S.T.-key  
(with electronic immobilizer and keyless entry system function)
- 2- Emergency key
- 3- Key number plate

**NOTE**

- The key (except for the emergency key) is a precision electronic device with a built-in signal transmitter. Please observe the following in order to prevent damage.
- Do not leave where it may be exposed to heat caused by direct sunlight, such as on top of the dashboard.
- Do not take the remote control transmitter apart.
- Do not excessively bend the key or subject it to strong impacts.
- Keep the remote control transmitter dry.
- Keep away from magnetic objects such as key rings.
- Keep away from devices that produce magnetism, such as audio systems, computers and televisions.
- Keep away from devices that emit strong electromagnetic waves, such as cellular phones, wireless devices and high frequency equipment (including medical devices).
- Do not clean with ultrasonic cleaners.
- Do not leave the key where it may be exposed to high temperature or high humidity.

## Free-hand Advanced Security Transmitter (F.A.S.T.-key)

**5**

### NOTE

- If you lose your key, to prevent the theft of the vehicle immediately contact a certified Mitsubishi EV dealer.  
If you notify a certified Mitsubishi EV dealer of the key number, they can make a new key. The key number is stamped on the key number plate. Keep the key number plate in a safe place separate from the key itself.
- If you wish to obtain an additional key, please contact a certified Mitsubishi EV dealer. A maximum of four key can be programmed for your vehicle.  
Also, to use the new keys, it is necessary to register the key with both the electronic immobilizer and keyless entry system. Refer to “Electronic immobilizer (Antitheft starting system): Customer F.A.S.T.-key programming” on page 5-17.
- No keys other than those registered in advance can be used to start the Plug-in Hybrid EV System.  
Refer to “Free-hand Advanced Security Transmitter (F.A.S.T.-key): “Electronic immobilizer (Anti-theft starting system)” on page 5-17.
- When the theft-alarm is in the system operational status, the alarm operates if a door or liftgate is opened after using the key, the door lock knob or the power door lock switch to unlock the vehicle.

### NOTE

- The system does not enter the preparation status if the keyless entry system or the F.A.S.T.-key operation was not used to lock the vehicle.

## Free-hand Advanced Security Transmitter (F.A.S.T.-key)

N00503101219

The Free-hand Advanced Security Transmitter (F.A.S.T.-key) enables the doors and the liftgate to be locked and unlocked, the Plug-in Hybrid EV System to be started and the operation mode to be changed simply by carrying it.

The F.A.S.T.-key can also be used as the remote control transmitter of the keyless entry system.

Refer to “Free-hand Advanced Security Transmitter (F.A.S.T.-key): Keyless entry system” on page 5-19.

**The F.A.S.T.-key must be carried by the driver. The F.A.S.T.-key is required for vehicle operations such as locking and unlocking the doors and the liftgate, starting the Plug-in Hybrid EV System and changing the operation mode. When leaving the vehicle, make sure you are carrying the F.A.S.T.-key and then lock the vehicle.**

### WARNING

- **Individuals who use implantable pacemakers or implantable cardiovascular-defibrillators should keep away from the external and internal transmitters. The electromagnetic waves used in the F.A.S.T.-key may affect the operation of implantable pacemakers and implantable cardiovascular-defibrillators.**

## Free-hand Advanced Security Transmitter (F.A.S.T.-key)

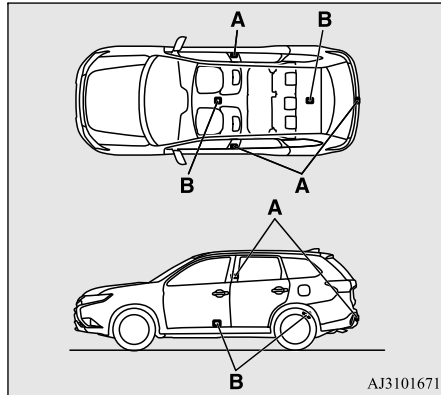

A- External transmitter  
B- Internal transmitter

### **WARNING**

- Individuals using other electro-medical apparatus besides implantable pacemakers and implantable cardiovascular-defibrillators should check with the manufacturer of the apparatus to confirm the effect of the electromagnetic waves used by the F.A.S.T.-key. The electromagnetic waves may affect the operations of the electro-medical apparatus.

The operations possible with the F.A.S.T.-key can be modified as stated below. (Keyless entry operations are possible.) For details, contact a certified Mitsubishi EV dealer.

- Enabling only the locking and unlocking of the doors and the liftgate
- Enabling only the starting of the Plug-in Hybrid EV System
- Deactivating the F.A.S.T.-key

### **NOTE**

- The F.A.S.T.-key uses weak electromagnetic waves. In cases such as the following, operation may be improper or unstable.
  - The vehicle is near a facility that emits strong electromagnetic waves, such as a TV transmitting tower, a power station, a radio station or an airport
  - The key is carried together with other communication devices such as cellular phones or radios, or electrical appliances such as computers
  - The F.A.S.T.-key touches or is covered by a metal object
  - A keyless entry system is being used nearby
  - The battery of the F.A.S.T.-key is run down
  - The vehicle is in a location with strong electromagnetic waves or noise

### **NOTE**

Use the emergency key to lock and unlock the driver's door in such circumstances.

Refer to "To operate without using the F.A.S.T.-key" on page 5-16.

- The F.A.S.T.-key is constantly performing reception operations in its communication with the vehicle. This means that the battery is always running down, regardless of how often the F.A.S.T.-key is used. The battery life is approximately 1 to 3 years, depending on the usage conditions.
- Since the F.A.S.T.-key is constantly performing reception operations, the reception of strong electromagnetic waves can accelerate the running down of the battery. Do not place near to electrical appliances such as televisions or computers.

5

### Operating range of the F.A.S.T.-key

N00503201278

When a person enters the operating range of the F.A.S.T.-key while carrying the F.A.S.T.-key and presses the driver's or front passenger's door lock/unlock switch, the liftgate LOCK switch or the liftgate OPEN switch, verification of the ID code is performed.

The doors and the liftgate can be locked and unlocked and the Plug-in Hybrid EV System can be started only when the ID codes of the vehicle and F.A.S.T.-key match.

## Free-hand Advanced Security Transmitter (F.A.S.T.-key)

5

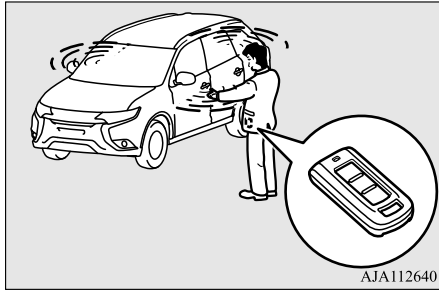

### NOTE

- When the battery of the F.A.S.T.-key has run down or there are strong electromagnetic waves or noise in the area, the operating range could decrease or operations could become unstable.

### Operating range for locking and unlocking the doors and the lift-gate

The operating range is within approximately 2.3 feet (70 cm) of the driver's and front passenger's door lock/unlock switch, the liftgate OPEN switch, and the liftgate LOCK switch.

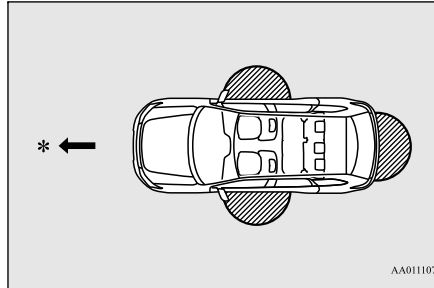

\*: Front of the vehicle

: Operating range

### NOTE

- The door or liftgate switch can only be used for locking or unlocking when a matching F.A.S.T.-key is detected.
- The system may not operate if the F.A.S.T.-key is too close to the windshield, door windows or liftgate.

### NOTE

- Even if the F.A.S.T.-key is within approximately 2.3 feet (70 cm) of the driver's and front passenger's door lock/unlock switch, the liftgate OPEN switch, and the liftgate LOCK switch, the system may not operate if the key is close to the ground or in a high position.
- If the F.A.S.T.-key is within the operating range, even a person not carrying the F.A.S.T.-key can lock and unlock the doors or the liftgate by pressing the driver's or front passenger's door lock/unlock switch, the liftgate LOCK switch or the liftgate OPEN switch.

## Free-hand Advanced Security Transmitter (F.A.S.T.-key)

### Operating range for starting the Plug-in Hybrid EV System and changing the operation mode

N00503301080

The operating range is the interior of the vehicle.

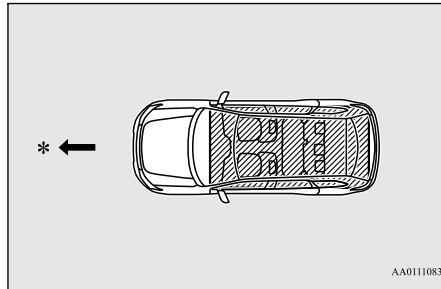

\*: Front of the vehicle

: Operating range

#### NOTE

- Even if the F.A.S.T.-key is within the operating range, it may not be possible to start the Plug-in Hybrid EV System and change the operation mode if the key is in a storage space such as the glove compartment, on top of the instrument panel, or in the door pocket or luggage compartment.

#### NOTE

- Even if the F.A.S.T.-key is inside the vehicle, it may not be possible to start the Plug-in Hybrid EV System and change the operation mode if the key is too close to a door or door window.

### To operate using the F.A.S.T.-key

N00503401502

#### To lock

While carrying the F.A.S.T.-key, press the driver's or front passenger's door lock/unlock switch (A), or the liftgate LOCK switch (B) within the operating range to lock all the doors and the liftgate.

The turn signal lights will blink once and the buzzer will sound once.

Also refer to "Doors locks", "Power door locks", "Liftgate" and "Power liftgate" on pages 5-24, 5-26, 5-28 and 5-30 respectively.

Driver's and front passenger's door lock/unlock switches

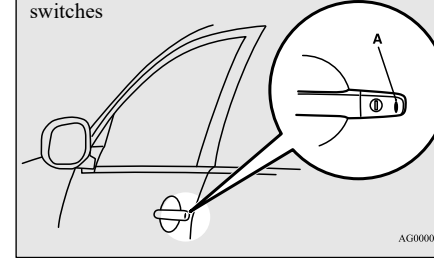

5

Liftgate switches

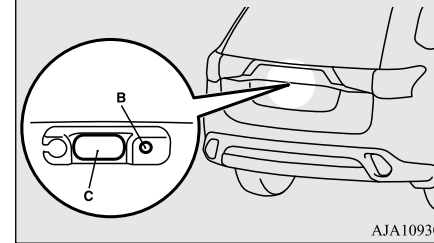

#### NOTE

- On the vehicles equipped with the mirror retractor switch, the outside rearview mirrors automatically retract when all doors and liftgate are locked using the driver's or front passenger's door lock/unlock switch (A) or the liftgate LOCK switch (B).
- In cases such as the following, the F.A.S.T.-key does not operate.

## Free-hand Advanced Security Transmitter (F.A.S.T.-key)

### NOTE

- There is a F.A.S.T.-key in the passenger compartment.
- A door or the liftgate is open or ajar.
- The operation mode is not in OFF.
- The liftgate OPEN switch (C) can be used to confirm that the vehicle is locked properly. Press the liftgate OPEN switch within approximately 3 seconds of locking.
- If the liftgate OPEN switch is pressed 3 seconds or more after the vehicle is locked, the doors and the liftgate are unlocked.
- The time within which locking confirmation is possible can be adjusted. See a certified Mitsubishi EV dealer for details. On a vehicle equipped with the Smartphone-link Display Audio (SDA), the function can be adjusted on the screen. For details, refer to the separate owner's manual.

5

### To unlock

While carrying the F.A.S.T.-key within the operating range, you can unlock the doors and the liftgate by using the F.A.S.T.-key operation.

The dome light will turn on for 30 seconds. The turn signal lights will blink twice and the buzzer will sound twice.

Also refer to “Door locks”, “Power door locks”, “Liftgate” and “Power liftgate” on pages 5-24, 5-26, 5-28 and 5-30 respectively.

5-8 Features and controls

Press the driver's door lock/unlock switch (A) to unlock only the driver's door. Within approximately 2 seconds, press the driver's door lock/unlock switch one more time to unlock all the doors and the liftgate.

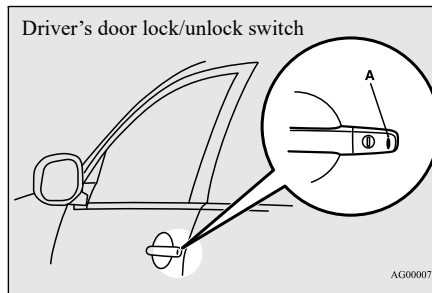

### NOTE

- On the vehicles equipped with the mirror retractor switch, the outside rearview mirrors automatically extend when the driver's door is unlocked using the driver's lock/unlock switch (A), front passenger's door lock/unlock switch (B) or the liftgate open switch (C).
- Settings can be changed so that all doors and the liftgate are unlocked automatically by pressing the driver's door lock/unlock switch once. Refer to “Setting of door and liftgate unlock function” on page 5-20.

Press the front passenger's door lock/unlock switch (B) or the liftgate OPEN switch (C) to unlock all the doors and the liftgate.

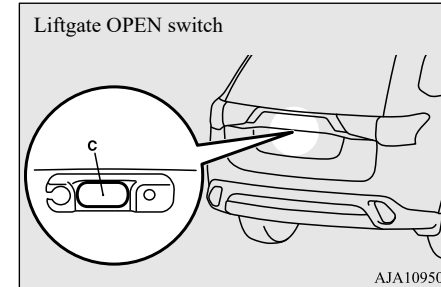
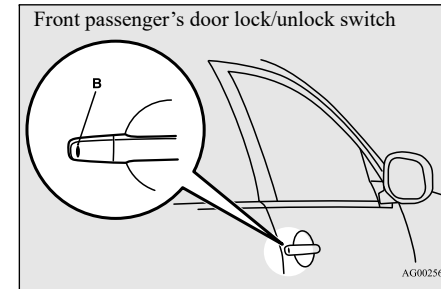



## Free-hand Advanced Security Transmitter (F.A.S.T.-key)

### NOTE

- If the doors and the liftgate are unlocked using the driver's or front passenger's door lock/unlock switch when all doors and the liftgate are locked and no doors or the liftgate are opened within approximately 30 seconds, the doors and the liftgate will automatically re-lock.
- The amount of time after unlocking until the vehicle re-locks automatically can be adjusted. See a certified Mitsubishi EV dealer for details.  
On a vehicle equipped with the Smartphone-link Display Audio (SDA), the functions can be adjusted on the screen. For details, refer to the separate owner's manual.
- The F.A.S.T.-key does not operate when the operation mode is not in OFF.
- The doors and the liftgate cannot be unlocked by using the liftgate OPEN switch for approximately 3 seconds after locking.
- The time within which locking confirmation is possible can be adjusted. See a certified Mitsubishi EV dealer for details.  
On a vehicle equipped with the Smartphone-link Display Audio (SDA), the function can be adjusted on the screen. For details, refer to the separate owner's manual.

### NOTE

- Functions settings can be modified as stated below.  
See a certified Mitsubishi EV dealer for details.  
On a vehicle equipped with the Smartphone-link Display Audio (SDA), the functions can be adjusted on the screen. For details, refer to the separate owner's manual.
- Activating the operation confirmation function (blinking of the turn signal lights) only during locking, or only during unlocking.
- Deactivating the operation confirmation function (blinking of the turn signal lights) and buzzer.
- Modifying the number of blinks in the operation confirmation function (blinking of the turn signal lights).
- Making the buzzer sound when the F.A.S.T.-key is removed from the passenger compartment when all the doors and the liftgate are closed.

### Power switch

N00513501199

### WARNING

- **When the vehicle is left in a closed or poorly ventilated area, never leave the Plug-in Hybrid EV system running and make sure that the ready indicator is not illuminated.**  
**While the ready indicator is illuminated, even if the engine is not running, the engine may automatically start later depending on the condition of the Plug-in Hybrid EV system and/or the main drive lithium-ion battery.**  
**If the engine runs in a closed or poorly ventilated area, carbon monoxide gas, which is odorless and extremely poisonous, could build up and cause serious injury or death.**

5

## Free-hand Advanced Security Transmitter (F.A.S.T.-key)

To prevent vehicle theft, no F.A.S.T.-keys other than those registered in advance can be used to start the Plug-in Hybrid EV System. (Electronic immobilizer function)  
While carrying the F.A.S.T.-key, the power switch can be used to start the Plug-in Hybrid EV System.

5

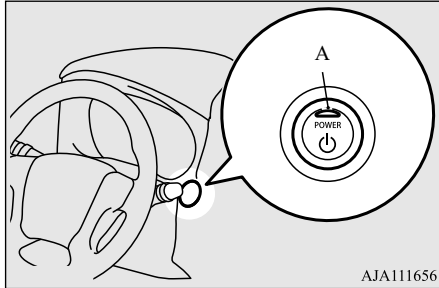

### CAUTION

- The indicator light (A) will flash orange when there is a problem or malfunction in Free-hand Advanced Security Transmitter. Never drive if the indicator light on the power switch is flashing orange. Immediately contact a certified Mitsubishi EV dealer.
- If the power switch operation is not smooth and feels like it is sticking, do not operate the switch. Immediately contact a certified Mitsubishi EV dealer.

### NOTE

- When operating the power switch, press the switch all the way in. If the switch is not fully pressed, the Plug-in Hybrid EV System may not start or the operation mode may not change. If the power switch is pressed correctly, there is no need to hold the power switch down.
- When the battery in the F.A.S.T.-key has worn out, or the F.A.S.T.-key is out of the vehicle, a warning display will appear.



### Operation mode of the power switch and its function

#### OFF

The indicator light on the power switch turns off.  
The operation mode cannot be put in OFF when the selector lever is in any position other than the “P” (PARK) position.

#### ACC

Allows operation of electrical accessories.  
The indicator light on the power switch illuminates orange.

#### ON

All electrical accessories can be used.  
The indicator light on the power switch illuminates blue.  
The indicator light illuminates for a few seconds and goes off when the Plug-in Hybrid EV System is operating.

### NOTE

- If the operation mode of the power switch is put in ON while the charge connector is connected, the indicator light on the power switch illuminates blue for a few seconds and goes off automatically.
- Your vehicle is equipped with an electronic immobilizer. To start the Plug-in Hybrid EV System, the ID code which the F.A.S.T.-key sends must match the one registered to the immobilizer computer. (Refer to “Electronic immobilizer (Anti-theft starting system)” on page 5-17)

## Free-hand Advanced Security Transmitter (F.A.S.T.-key)

**Changing the operation mode**

N00568001123

If you press the power switch without pressing the brake pedal while the vehicle is stationary, you can change the operation mode in the order of OFF, ACC, ON, OFF.

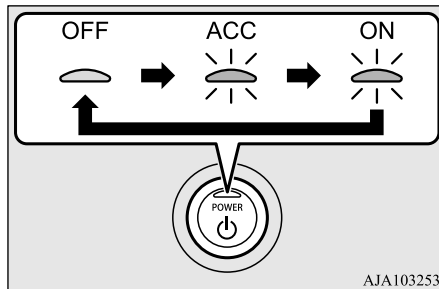

AJA103253

**CAUTION**

- When the Plug-in Hybrid EV System is not operating, put the operation mode in OFF. Leaving the operation mode in ON or ACC for a long time when the Plug-in Hybrid EV System is not operating may cause the 12 V starter battery to be discharged, making it impossible to start the Plug-in Hybrid EV System.

**CAUTION**

- When the 12 V starter battery is disconnected, the current operation mode is memorized. After reconnecting the 12 V starter battery, the memorized mode is selected automatically. Before disconnecting the 12 V starter battery for repair or replacement, make sure to put the operation mode in OFF. Be careful if you are not sure which operation mode the vehicle is in when the 12 V starter battery is run down.
- The operation mode cannot be changed from OFF to ACC or ON if the F.A.S.T.-key is not detected to be in the vehicle. Refer to “Operating range for starting the Plug-in Hybrid EV System and changing the operation mode” on page 5-7.
- When there is the F.A.S.T.-key in the vehicle and the operation mode is not changed, the battery in the F.A.S.T.-key may have worn out. Refer to “Warning activation” on page 5-12.

**NOTE**

- If the operation mode cannot be changed to OFF, perform the following procedure.
  - Press the electrical parking switch and lock the wheels, and then change the operation mode to OFF.

**NOTE**

- One of the other causes could be low 12 V starter battery voltage. If this occurs, the keyless entry system and the F.A.S.T.-key operation will also not operate. Contact a certified Mitsubishi EV dealer.

**ACC power auto-cutout function**

N00568101124

After approximately 30 minutes has elapsed with the operation mode in ACC, the function automatically cuts out the power for the audio system and other electric devices that can be operated with that mode.

When the power switch is pressed after activation of ACC power auto-cutout function, the power is supplied again to those devices.

**NOTE**

- It is possible to modify functions as follows:
  - The time until the power cuts out can be changed to approximately 60 minutes.
  - The ACC power auto-cutout function can be deactivated.
 For details, we recommend you to consult a certified Mitsubishi EV dealer. On vehicles equipped with the Smartphone-link Display Audio (SDA), screen operations can be used to make the adjustment. Refer to the separate owner’s manual for details.

## Free-hand Advanced Security Transmitter (F.A.S.T.-key)



**Warning activation**

N00503501297



With the F.A.S.T.-key, warnings are given through buzzers and displays on the information screen in the multi-information display in order to prevent mistaken operations or vehicle theft.

When a warning operates, be sure to check the vehicle and the F.A.S.T.-key. A warning is also displayed if there is a problem in the F.A.S.T.-key.

**5**

Item	Display	Buzzer	Solution	Note
Detection of failure		Inner buzzer sounds once	There is a problem in the F.A.S.T.-key.	—
		Inner buzzer sounds once	There is a fault in the electronic immobilizer (Anti-theft starting system).	Put the operation mode in OFF and then start the Plug-in Hybrid EV System again. If the warning is not canceled, contact a certified Mitsubishi EV dealer.
Fall of battery voltage		Inner buzzer sounds once	The battery of the F.A.S.T.-key is run down.	The warning is not activated if the battery is completely dead.



Free-hand Advanced Security Transmitter (F.A.S.T.-key)

Item	Display	Buzzer	Solution	Note
F.A.S.T.-key take-out monitoring system		Inner buzzer sounds once  Outer buzzer sounds intermittently	When the vehicle is parked with the operation mode in any mode other than OFF, if you close the door after opening any of the doors and taking the F.A.S.T.-key out of the vehicle, a warning is issued until the F.A.S.T.-key is detected in the vehicle.	<ul style="list-style-type: none"> <li>•The F.A.S.T.-key take-out monitoring system does not function if the F.A.S.T.-key is removed through a window without opening a door. This setting can be changed. Contact a certified Mitsubishi EV dealer for details.</li> <li>•The warning may display even if the F.A.S.T.-key is in the operating range for starting the Plug-in Hybrid EV System and changing the operation mode. The surrounding environment or electromagnetic waves may make it impossible to verify the ID codes of the F.A.S.T.-key and vehicle.</li> </ul>
Key lock-in prevention system		Inner buzzer sounds once  Outer buzzer sounds approximately 3 seconds intermittently	When the operation mode is in OFF, the F.A.S.T.-key is left in the passenger compartment, all the doors and the liftgate are closed, and someone tries to lock the vehicle by pressing the driver's or front passenger's door lock/unlock switch, or the liftgate LOCK switch, a warning is issued and you cannot lock the doors and liftgate.	Make sure you have the F.A.S.T.-key with you before locking the doors. Even if you leave the F.A.S.T.-key inside the vehicle, it is possible that the doors will lock depending on the surrounding environment and wireless signal conditions.

5

5

### Free-hand Advanced Security Transmitter (F.A.S.T.-key)

Item	Display	Buzzer	Solution	Note
Door ajar prevention system		Inner buzzer sounds once  Outer buzzer sounds approximately 3 seconds intermittently	When the operation mode is in OFF, and someone tries to lock the vehicle by pressing the driver's or front passenger's door lock/unlock switch, or the liftgate LOCK switch while one of the doors or the liftgate is not fully closed, a warning is issued and you cannot lock the doors and liftgate.	—
Operation mode OFF reminder system		Inner buzzer sounds once  Outer buzzer sounds approximately 3 seconds intermittently	When the operation mode is in any mode other than OFF, and someone tries to lock the vehicle by pressing the driver's or front passenger's door lock/unlock switch, or the liftgate LOCK switch, a warning is issued and you cannot lock the doors and liftgate.	—

### Starting the Plug-in Hybrid EV System

N00588100022

#### CAUTION

- When the Plug-in Hybrid EV System warning light comes on while the READY indicator is on, avoid high-speed driving and have your vehicle inspected by a certified Mitsubishi EV dealer as soon as possible. (Refer to “Plug-in Hybrid EV System warning light” on page 5-189.)

#### CAUTION

- Never attempt to start the Plug-in Hybrid EV System by pushing or pulling the vehicle.

1. Check that the EV charging cable is not connected to your vehicle.
2. Fasten the seat belt.
3. Make sure the parking brake is applied.
4. Press and hold the brake pedal down firmly with your right foot.

5. When you press the power switch while depressing the brake pedal, the READY indicator in the meter blinks and the activation of Plug-in Hybrid EV System starts.
6. When the READY indicator changes from blinking to staying on, the startup of Plug-in Hybrid EV System is activated and the vehicle is now ready to drive.

## Free-hand Advanced Security Transmitter (F.A.S.T.-key)

### CAUTION

- Do not press the power switch while holding the select lever at the operated position.

### NOTE

- Continue to depress the brake pedal until the READY indicator in the meter stays on.
- After the Plug-in Hybrid EV System has not started for a while, the brake pedal effort needed to start the Plug-in Hybrid EV System may become greater. If this occurs, depress the brake pedal more than usual.
- You can drive your vehicle even if the engine is stopped.
- Plug-in Hybrid EV System can be started in any operation mode.
- If the READY indicator does not come on, check the select position indicator. If the indicator is not indicating "P", press the electrical parking switch to display "P" position.
- If the READY indicator does not come on, turn the power switch to OFF once and, after a while, press the power switch to start Plug-in Hybrid EV System.

### Stopping the Plug-in Hybrid EV System

N00588200023

1. Stop your vehicle completely.

2. Apply the parking brake firmly while depressing the brake pedal.
3. After pressing the electrical parking switch, press the power switch to stop Plug-in Hybrid EV System. (Refer to "Electrical Parking switch" on page 5-55)

### WARNING

- **Never stop Plug-in Hybrid EV System during running except in emergency. The effectiveness of the brake becomes very poor and the steering wheel becomes very heavy, which can easily lead to an accident.**

### NOTE

- Do not operate the power switch during running except in emergency. If you have to stop Plug-in Hybrid EV System in emergency during running, continue to press the power switch for three seconds or longer or press the power switch three times or more quickly. Plug-in Hybrid EV System stops, the operation mode turns to ACC, and the selector lever position shifts to the "P" position at very slow speed.
- If you press the power switch when the selector lever position is other than "P" position while your vehicle is stopped, the selector lever position automatically shifts to "P" position, Plug-in Hybrid EV System stops, and the power mode turns to "OFF".

### NOTE

- If the parking lock mechanism is faulty, a warning is displayed on the information screen in the multi-information display. When this warning is displayed, Plug-in Hybrid EV System cannot be stopped unless you apply the parking brake and then press the power switch. Park on a flat place with the parking brake securely applied. Have your vehicle inspected by a certified Mitsubishi EV dealer.



5

### If the F.A.S.T.-key is not operating properly

N00568301070

Insert the F.A.S.T.-key into the key slot in the instrument panel. Starting the Plug-in Hybrid EV System and changing the operation mode should be now possible.

Remove the F.A.S.T.-key from the key slot after starting the Plug-in Hybrid EV System or changing the operation mode.

## Free-hand Advanced Security Transmitter (F.A.S.T.-key)

5

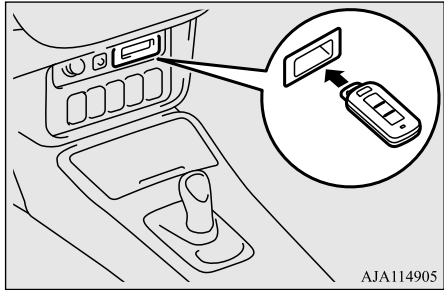

AJA114905

### NOTE

- Do not insert into the key slot anything other than the F.A.S.T.-key. This could cause damage or a malfunction.
- Remove the object or additional key from the F.A.S.T.-key before inserting the key into the key slot. The vehicle may not be able to receive the registered ID code from the registered key. Therefore, the Plug-in Hybrid EV System may not start and the operation mode may not change.
- The F.A.S.T.-key is fixed in the key slot when inserted in the illustrated direction. Simply pull out the key to remove it from the key slot.

### F.A.S.T.-key reminder

Warning display



If the operation mode is in OFF and the driver's door is opened with the F.A.S.T.-key in the key slot, a warning is issued with the warning display and the buzzer buzzing for approximately 3 seconds to remind you to remove the key.

### To operate without using the F.A.S.T.-key

N00514800017

### Emergency key

N00515201187

The emergency key is built into the F.A.S.T.-key.

When the F.A.S.T.-key cannot be used, such as when the battery of the F.A.S.T.-key or the vehicle has run down, the emergency key can be used to lock and unlock the driver's door.

To use the emergency key (A), unlock the lock knob (B) and remove it from the F.A.S.T.-key (C).

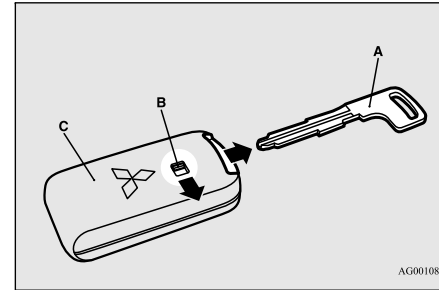

AG0010823

### NOTE

- Only use the emergency key in an emergency. When the battery of the F.A.S.T.-key has run down, replace the battery as soon as possible and use it as a F.A.S.T.-key again.
- After using the emergency key, be sure to reinsert it into the F.A.S.T.-key.



## Free-hand Advanced Security Transmitter (F.A.S.T.-key)

### Locking and unlocking the driver's door

Turn the emergency key toward the front of the vehicle to lock the door. After checking that the door is locked, turn the emergency key back to the center and remove it.

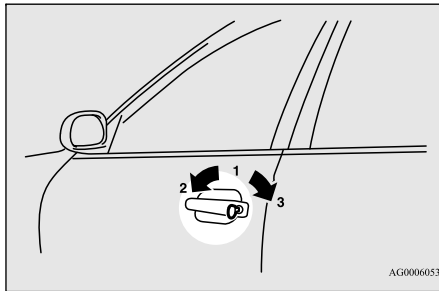

- 1- Insert or remove the emergency key
- 2- Lock
- 3- Unlock

### Electronic immobilizer (Anti-theft starting system)

The electronic immobilizer is designed to significantly reduce the possibility of vehicle theft. The purpose of the system is to immobilize the vehicle if an invalid start is attempted. A valid start attempt can only be achieved (subject to certain conditions) using

a F.A.S.T.-key “registered” to the immobilizer system.

All of the keys provided with your new vehicle have been programmed to the vehicle's electronics.

### CAUTION

- Do not make any alterations or additions to the immobilizer system. Alterations or additions could cause failure of the immobilizer.

### Replacement F.A.S.T.-keys

N00561001065

Only the F.A.S.T.-keys that have been programmed to the vehicle's electronics can be used to start the vehicle.

If you lose the F.A.S.T.-key, you can order a F.A.S.T.-key from a certified Mitsubishi EV dealer by referring to the key number.

To prevent vehicle theft, take your vehicle and the remaining F.A.S.T.-keys to a certified Mitsubishi EV dealer to have the ID codes reprogrammed.

### Additional F.A.S.T.-keys

N00561101079

To add a F.A.S.T.-key, you must already have two registered F.A.S.T.-keys. You need to register the ID code to the vehicle.

Registering the ID code can be done by a certified Mitsubishi EV dealer. Or it can be done by yourself (except for vehicles sold in Canada).

For you to register the ID code yourself, follow the “Customer F.A.S.T.-key programming” procedure below.

If you choose to have a certified Mitsubishi EV dealer register the ID code, take your vehicle and all remaining F.A.S.T.-keys to a certified Mitsubishi EV dealer.

5

### NOTE

- You are provided with two F.A.S.T.-keys, but you may register up to four F.A.S.T.-keys. You can obtain blank F.A.S.T.-keys specially cut for your vehicle from a certified Mitsubishi EV dealer.

### Customer F.A.S.T.-key programming (Except for vehicles sold in Canada)

N00561201344

You can program new F.A.S.T.-keys to the system if you have two valid (already registered) F.A.S.T.-keys and a blank (not registered) F.A.S.T.-key.

For F.A.S.T.-key programming, follow the procedures below.

## Free-hand Advanced Security Transmitter (F.A.S.T.-key)

1. Open the driver's door.

### NOTE

- Keep the driver's door open until F.A.S.T.-key programming is finished. Do not open or close other doors.

**5**

2. While carrying the first valid F.A.S.T.-key, put the operation mode in ON. (Perform the following procedure within 30 seconds.)

3. Insert the new F.A.S.T.-key into the key slot in the illustrated direction.

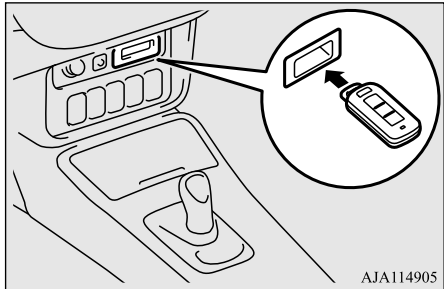

4. With the first valid F.A.S.T.-key, press the UNLOCK button for 4 to 8 seconds and press the LOCK button during this time.

5. Release in sequence the LOCK and UNLOCK buttons within 8 seconds of pressing the LOCK button in step 4. (Perform the following procedure within 30 seconds.)

6. With the second valid F.A.S.T.-key, press the UNLOCK button for 4 to 8 seconds and press the LOCK button during this time.

7. Release in sequence the LOCK and UNLOCK buttons within 8 seconds of pressing the LOCK button in step 6. The immobilizer display on the information screen in the multi-information display will blink (Perform the following procedure within 20 seconds.)



When registration of ID code is complete, the buzzer will sound three times and the immobilizer display will come on for 30 seconds.

If an error occurs, F.A.S.T.-key programming will be terminated and the buzzer will sound for 3 seconds.

### NOTE

- F.A.S.T.-key programming will be terminated if the operation mode is put in OFF before the immobilizer display starts blinking.

8. If you wish to register another F.A.S.T.-key, repeat the process from step 1 after the operation mode is put in OFF.

9. When all F.A.S.T.-keys are registered, remove the F.A.S.T.-key from the key slot.

### NOTE

- The immobilizer display will go off immediately if the operation mode is put in OFF.
- Perform the operation when the interrupt display screen is not showing. The interrupt display screen may prevent you from seeing the immobilizer display.
- It is not possible to register a F.A.S.T.-key if the immobilizer display goes off during the procedure.

## Free-hand Advanced Security Transmitter (F.A.S.T.-key)

## Keyless entry system

N00515501409

Press the remote control transmitter buttons to lock or unlock the doors and the liftgate. It can also help you signal for attention by setting off the panic alarm.

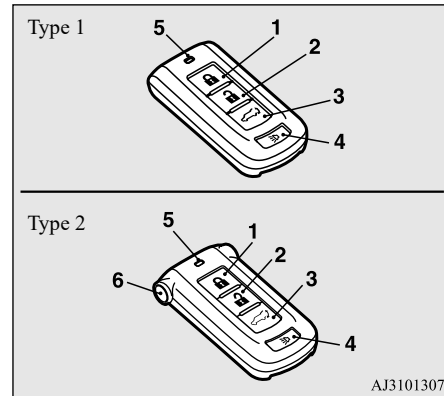

- 1- LOCK (🔒) button  
 2- UNLOCK (🔓) button  
 3- Power liftgate button (if so equipped)  
 4- PANIC button  
 5- Operation indicator light  
 6- Charging timer cancel switch (if so equipped)

## NOTE

- For the operation of the power liftgate button (3), refer to “Power liftgate” on page 5-30.
  - For the operation of the Charging timer cancel switch (6), refer to “MITSUBISHI Remote Control” on page 3-38.
  - The indicator light (5) comes on each time a button is pressed.
  - On vehicles equipped with the mirror retractor switch, the outside rearview mirrors automatically retract or extend when the doors and the liftgate are locked or unlocked using the remote control transmitter buttons. Refer to “Features and controls: Outside rearview mirrors” on page 5-52.
  - If the following conditions are observed after pressing the LOCK (1) or UNLOCK (2) button on the remote control transmitter, the battery in the F.A.S.T.-key may need to be replaced.
    - The doors and the liftgate cannot be locked or unlocked.
    - The panic alarm cannot be operated.
    - The indicator light (5) is dim or does not come on.
- Refer to “Procedure for replacing the remote control transmitter battery” on page 5-23.

## To lock

Press the LOCK button (1) to lock all the doors and the liftgate.

The turn signal lights will also blink once.

## NOTE

- If you press the LOCK button (1) twice, the horn will sound once.

## To unlock

5

Press the UNLOCK button (2) to unlock the driver’s door only.

Within approximately 2 seconds, press the UNLOCK button one more time to unlock all the doors and liftgate.

The dome light will turn on for 30 seconds. The turn signal lights will also blink twice. The front side-marker and parking lights will also turn on for approximately 30 seconds. Refer to “Welcome light” on page 5-197.

## NOTE

- If the UNLOCK button (2) is pressed and no doors or the liftgate are opened within approximately 30 seconds, the doors and the liftgate will automatically re-lock. On vehicle equipped with the Smartphone-link Display Audio (SDA), the functions can be adjusted on the screen. For details, refer to the separate owner’s manual.

## Free-hand Advanced Security Transmitter (F.A.S.T.-key)

### NOTE

- The door and liftgate unlock function can be set so that all doors and liftgate unlock when the UNLOCK button (2) is pressed once. Refer to “Setting of door and liftgate unlock function” on page 5-20.

## 5 Answerback function

N00544501137

The horn and turn signal lights of the keyless entry system answerback function can be changed as required. This is done with the operation mode in OFF.

### NOTE

- On a vehicle equipped with the Smartphone-link Display Audio (SDA), the functions can be adjusted on the screen. For details, refer to the separate owner’s manual.

### ■ Horn deactivation/reactivation

N00597200045

The answerback function can be set in the following three ways.

Each time the answerback function is set, a chime will sound to tell you the condition of the answerback function.

Number of chimes	Condition
One chime	The horn will not sound.
Two chimes	The horn will sound.
Four chimes	The horn will sound if the LOCK button (1) is pressed twice within 1 second.

To change the setting, refer to “Customizing the Free-hand Advanced Security Transmitter (F.A.S.T.-key)” on page 5-22.

### ■ Turn signal light deactivation/reactivation

N00597300046

The answerback function from the turn signal lights can be turned ON or OFF separately. Each time the answerback function is set, a chime will sound to tell you the condition of the answerback function.

Number of chimes	To lock	To unlock
One chime	One flash	Two flashes
Two chimes	One flash	No flash
Three chimes	No flash	Two flashes
Four chimes	Two flashes	One flash
Five chimes	No flash	One flash

Number of chimes	To lock	To unlock
Six chimes	Two flashes	No flash
Seven chimes	No flash	No flash

To change the setting, refer to “Customizing the Free-hand Advanced Security Transmitter (F.A.S.T.-key)” on page 5-22.

### ■ Buzzer deactivation/reactivation

N00597400047

The buzzer answerback function can be turned ON or OFF as required.

### Setting of door and liftgate unlock function

N00544601268

The door and liftgate unlock function can be set to the following two conditions.

Each time the door and liftgate unlock function is set, a chime will sound to tell you the condition of the door and liftgate unlock function.

## Free-hand Advanced Security Transmitter (F.A.S.T.-key)

Number of chimes	Condition
One chime [Factory setting]	When the UNLOCK button, driver's or front passenger's door lock/unlock switch, or liftgate OPEN switch is pressed one time, all doors and the liftgate unlock.
Two chimes	When the UNLOCK button or the driver's door lock/unlock switch is pressed one time, only the driver's door unlocks. When the UNLOCK button or the driver's door lock/unlock switch is pressed two times in succession, all doors and the liftgate unlock.

To change the setting, refer to “Customizing the Free-hand Advanced Security Transmitter (F.A.S.T.-key)” on page 5-22.

### Operating the power liftgate

N00579500020

After unlocking the doors and the liftgate, the power liftgate can be operated by pressing the power liftgate button (3). Refer to “Power liftgate” on page 5-30.

### Using the panic alarm

N00544701197

If you are near your vehicle and feel threatened, you can activate the alarm to call attention as follows:

1. Press the PANIC button (4) for more than 1 second.
2. The headlights will blink on and off and the horn will sound intermittently for approximately 3 minutes.
3. To turn off the alarm, press any button on the remote control transmitter.

#### NOTE

- The F.A.S.T.-key can be used from approximately 40 feet (12 m) away. However, this distance may change if your vehicle is near a TV transmitting tower, a power station, or a radio station.

Free-hand Advanced Security Transmitter (F.A.S.T.-key)





**Customizing the Free-hand Advanced Security Transmitter (F.A.S.T.-key)**

N00596600042

You can change the settings for the following functions according to your preferences. When changing a setting, perform the following steps.

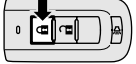
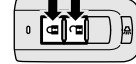
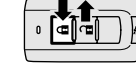
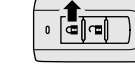
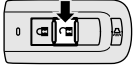
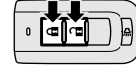
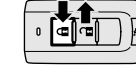
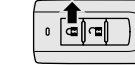
1. Put the operation mode in OFF.
2. Open the driver's door and turn the combination headlights and dimmer switch to the "OFF" position.
3. Complete steps i to iv of the procedure. Steps ii to iv should be completed within 8 seconds.

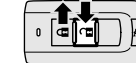
**5**

Item	Step i	Step ii	Step iii	Step iv	Notification
Horn deactivation/reactivation	Press and hold the LOCK button (1) for 4 to 8 seconds. 	While holding the LOCK button (1), press the UNLOCK button (2). 	While holding the LOCK button (1), release the UNLOCK button (2). 	Release the LOCK button (1). 	Chimes → Page 5-20
Turn signal lights deactivation/reactivation	Press and hold the UNLOCK button (2) for 4 to 8 seconds. 	While holding the UNLOCK button (2), press the LOCK button (1). 	While holding the LOCK button (1), release the UNLOCK button (2). 	Release the LOCK button (1). 	Chimes → Page 5-20
Setting the door and liftgate unlock function	Press and hold the LOCK button (1) for 4 to 8 seconds. 	While holding the LOCK button (1), press the UNLOCK button (2). 	While holding the UNLOCK button (2), release the LOCK button (1). 	Release the UNLOCK button (2). 	Chimes → Page 5-20

## Free-hand Advanced Security Transmitter (F.A.S.T.-key)

 **NOTE**

- Be sure to press the buttons correctly when performing the procedures. If you perform the procedures incorrectly, the settings could be changed unintentionally.

**General information**

N00562001121

Your F.A.S.T.-key operates on a radio frequency subject to Federal Communications Commission (FCC) Rules (For vehicles sold in U.S.A.) and Industry Canada Rules (For vehicles sold in Canada). This device complies with Part 15 of FCC Rules and Industry Canada licence-exempt RSS standard(s). Operation is subject to the following two conditions.

- This device may not cause harmful interference.
- This device must accept any interference received, including interference that may cause undesired operation.

 **CAUTION**

- Changes or modifications not expressly approved by the manufacturer for compliance could void the user's authority to operate the equipment.

**Para los vehículos vendidos en México**

La operación de este equipo está sujeta a las siguientes dos condiciones: (1) es posible que este equipo o dispositivo no cause interferencia perjudicial y (2) este equipo o dispositivo debe aceptar cualquier interferencia, incluyendo la que pueda causar su operación no deseada.

**Procedure for replacing the remote control transmitter battery**

N00562101207

 **WARNING**

- Do not swallow a coin type battery.
- This product contains coin type battery. If a coin type battery is swallowed, it can cause severe internal burns and can lead to death. There have been cases where a swallowed battery has caused severe internal burns in just 2 hours.

 **WARNING**

- Keep new and used batteries away from children.
- If the remote control transmitter case does not close securely, stop using the product and keep it away from children.
- If you think batteries might have been swallowed or placed inside any part of a person's body, seek immediate medical attention.
- To prevent an explosion or leakage of flammable liquid or gas:
  - Do not replace the battery with an incorrect type. Replace only with the same or equivalent type.
  - Do not dispose of a battery into a fire or incinerator, or by mechanically crushing or cutting the battery.
  - Do not use, store, or take a battery any place where it may be exposed to extremely high temperature or extremely low air pressure.

 **CAUTION**

- When the remote control transmitter case is opened, be careful to keep water, dust, etc. out. Also, do not touch the internal components.

## Door locks

### ⚠ CAUTION

- Dispose of used battery according to regulations for the disposal of battery.

1. Before replacing the battery, remove static electricity from your body by touching a metal grounded object.
2. Remove the emergency key from the key. Refer to “Emergency key” on page 5-16.
3. With the Mitsubishi mark facing you, insert the cloth-covered tip of a flat blade screwdriver into the notch in the case and use it to open the case.

**5**

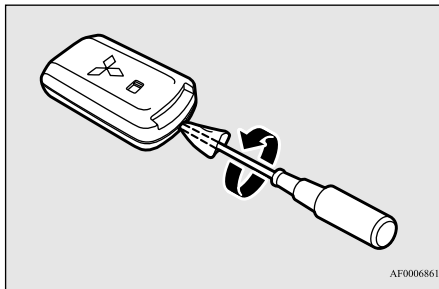

### 📖 NOTE

- Be sure to perform the procedure with the Mitsubishi mark facing you. If the Mitsubishi mark is not facing you when you open the case, the transmitter may come out.

4. Remove the used battery.

5. Install a new battery with the +side (A) up.

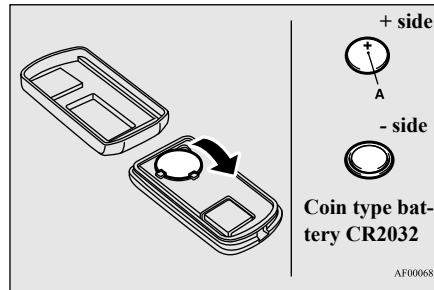

6. Close the case firmly.
7. Install the emergency key removed in step 2.
8. Check the keyless entry system to see that it works.

### 📖 NOTE

- You may purchase a replacement battery at an electric appliance store.
- A certified Mitsubishi EV dealer can replace the battery for you if you prefer.

## Door locks

N00509201560

### ⚠ WARNING

- Make sure all doors are tightly closed and locked while driving.

### ⚠ WARNING

- Locked doors, in combination with the use of seat belts, can help reduce the risk of ejection in an accident.
- Locked doors can help keep passengers, especially small children, from opening doors and falling out of moving vehicles.
- Locked doors can help prevent outsiders from gaining access to your vehicle when you slow or come to a stop.
- Lock your vehicle whenever you leave it. Children who get into unlocked vehicles may not be able to get out. Children trapped inside vehicles can quickly be overcome by heat and suffer serious injury or death due to heat stroke.
- Never leave a child alone in the vehicle. In addition to the risk of heat stroke, children can activate switches and controls, resulting in an injury or fatal accident.
- When closing a door, make sure that the door is fully closed and the door-ajar warning display goes out on the information screen on the multi-information display. If the door is ajar it could open while driving and cause an accident.



### To lock and unlock with the emergency key (driver's door)

The driver's door can be locked and unlocked using the emergency key.

Refer to "Emergency key" on page 5-16.

Turn the emergency key toward the front of the vehicle to lock the door. After checking that the door is locked, turn the emergency key back to the center and remove it.

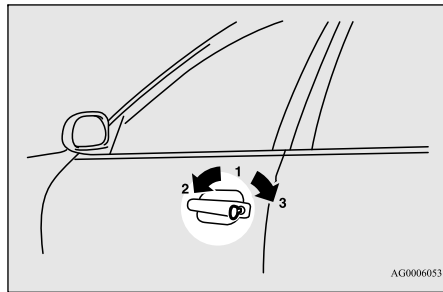

- 1- Insert or remove the emergency key
- 2- Lock
- 3- Unlock

### NOTE

- When locking or unlocking with the emergency key, only the driver's door will be locked or unlocked.  
To lock or unlock all doors and liftgate, use the power door lock switch, the keyless entry system or the F.A.S.T.-key operation.  
Refer to "Power door locks" on page 5-26, "Keyless entry system" on page 5-19 and "To operate using the F.A.S.T.-key" on page 5-7.
- On vehicles equipped with the charging lid lock, the charging lid can be locked or unlocked at the same time when driver's door is locked or unlocked using the emergency key.  
However, the charging lid cannot be unlocked while the operation mode of the power switch is in ON.

### To lock or unlock the door from the inside

Move the lock knob to the lock position to lock the door.

All doors should be kept locked while driving.

5

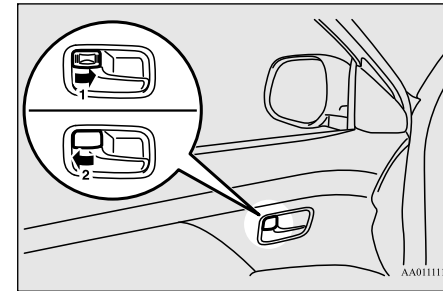

- 1- Lock
- 2- Unlock

The driver's door can be unlocked without using the lock knob by pulling on the inside door handle.

## Power door locks

### NOTE

- On vehicles equipped with the charging lid lock, the charging lid can be locked or unlocked at the same time when driver's door is locked or unlocked using the lock knob. However, the charging lid cannot be unlocked while the operation mode of the power switch is in ON.

5

### To lock the door without using the key

1. Move the inside lock knob to the locked position.
2. Be sure the keys are not inside the vehicle. Close the door.

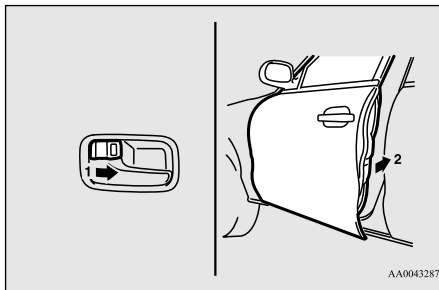

### Lock out protection

N00517301065

If the key operation mode is in any mode other than OFF, when you push the lock knob forward with the driver's door or passenger's door open, the lock knob will automatically return to the unlocked position.

### Operation mode ON reminder system

N00503801160



If the driver's door is opened while the Plug-in Hybrid EV System is stopped and the operation mode is in any mode other than OFF, the operation mode ON buzzer will sound intermittently to remind you put the operation mode in OFF.

The warning display will be displayed on the information screen in the multi-information display.

### Power door locks

N00509301675

### NOTE

- When locking or unlocking with the key on the driver's door, only the driver's door will lock or unlock.
- Repeated continuous operation between lock and unlock could activate the power door locking system's built-in protection circuit, and prevent the system from operating. If this occurs, wait approximately 1 minute before operating the power door lock switch.

## To lock and unlock the doors and liftgate

### Using the power door lock switch

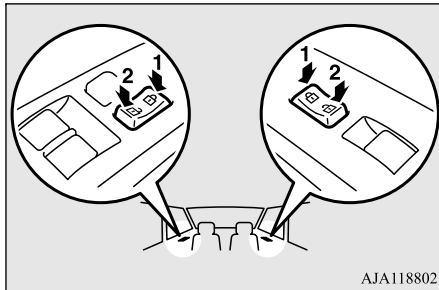

- 1- Lock
- 2- Unlock

All of the doors and the liftgate can be locked or unlocked by pressing the power door lock switch on the driver's or the front passenger door.

### NOTE

- On vehicles equipped with the charging lid lock, the charging lid can be locked or unlocked at the same time when driver's door is locked or unlocked using the power door lock switch. However, the charging lid cannot be unlocked while the operation mode of the power switch is in ON.

## To unlock the doors and liftgate

N00563401278

You can select the functions to unlock the doors and liftgate either using the power switch or using the electrical parking switch.

These functions are not activated when the vehicle is shipped from the factory. To activate or deactivate these functions, please contact a certified Mitsubishi EV dealer.

## Using the power switch

All doors and the liftgate will unlock when the operation mode is put in OFF.

## Using the electrical parking switch

All doors and the liftgate will unlock when the electrical parking switch is pressed with the operation mode in ON.

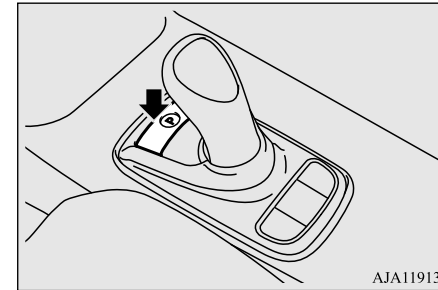

5

### NOTE

- On a vehicle equipped with the Smartphone-link Display Audio (SDA), the functions can be adjusted on the screen. For details, refer to a separate owner's manual.

## Child safety locks for rear door

### Child safety locks for rear door

N00509401298

5

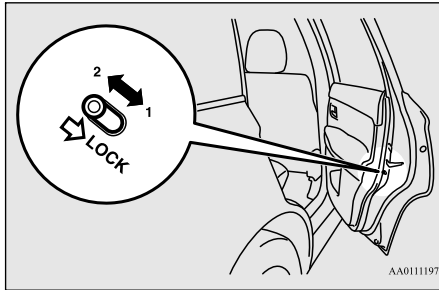

- 1- To lock  
2- To release

Child safety locks help prevent rear passengers, especially children, from opening the rear door using the inside door handle.

A lock lever for the child safety lock is provided on each rear door.

When the lever is in the lock position (1), the rear door cannot be opened using the inside door handle.

To open the rear door when the child safety lock lever is in the lock position, pull the outside door handle.

When the lever is in the release position (2), the child safety lock is released and the rear

door can be opened using the inside door handle.

#### WARNING

- Always keep the doors tightly closed and locked when driving. An unlocked door may be accidentally opened by a passenger, especially by a child who could fall out. Also, if the doors are not locked, there is a greater risk of someone being thrown from the vehicle in an accident.

#### Liftgate (except for vehicles equipped with the power liftgate)

N00510101341

#### WARNING

- It is dangerous to drive with the liftgate open since carbon monoxide (CO) gas contained in engine exhaust gases can enter the passenger compartment. CO is an invisible, odorless gas that can cause unconsciousness and even death.
- When opening and closing the liftgate, make sure that there are no people nearby and be careful not to hit your head or pinch your hands, neck, etc.

#### WARNING

- If snow or ice has accumulated on the liftgate, remove it before opening the liftgate. Otherwise the liftgate may abruptly close due to the weight of the snow or ice.
- When opening the liftgate, always fully open it. A partially opened liftgate can unexpectedly close due to its own weight.
- When the vehicle is parked on a slope, the effort required to open or close the liftgate may be greater or less than expected. The liftgate may also open or close more quickly.

#### CAUTION

- Do not stand behind the exhaust pipe when loading and unloading luggage with engine running. Heat from the exhaust could lead to burns.
- To avoid damage to the liftgate, make sure that area above and behind the liftgate is clear before opening it.

#### NOTE

- Locking and unlocking the doors by using power door locks (driver and front passenger side), keyless entry system, or F.A.S.T.-key operation also locks and unlocks the liftgate.

## Liftgate (except for vehicles equipped with the power liftgate)

### To open

1. After unlocking, push the liftgate open switch (A) and raise the liftgate.

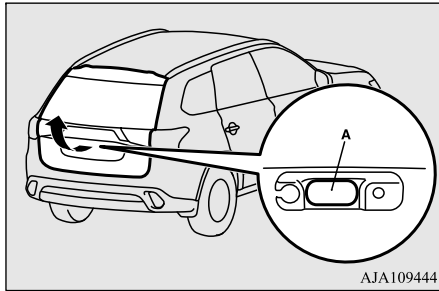

### CAUTION

- Make sure there is no one standing nearby when opening the liftgate.

### NOTE

- The liftgate cannot be raised if it is not raised immediately after pressing the liftgate open switch. If this happens, raise the liftgate again after pressing the liftgate open switch.
- It is not possible to open the liftgate while the 12 V starter battery is disconnected. If necessary, use the inside liftgate release.

### NOTE

- When the 12 V starter battery is reconnected, all doors and the liftgate will be locked. Unlock them before trying to open the liftgate.
- On vehicles equipped with the mirror retractor switch, the outside rearview mirrors automatically extend when the liftgate and all doors are unlocked using the liftgate open switch (A).

### To close

1. Pull the liftgate grip (B) downward as illustrated and release it before the liftgate closes completely. Gently close the liftgate from the outside so that it is completely closed.

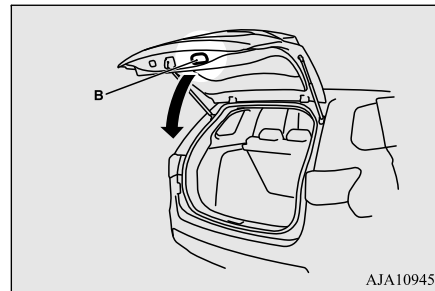

### CAUTION

- To avoid injuring your hand or arm, do not attempt to close the liftgate without releasing the liftgate grip (B).
- Before starting the vehicle, be sure to confirm that the liftgate is locked. If the liftgate opens while driving the vehicle, objects stored in the luggage compartment could fall out into the road.

### NOTE

- Gas struts (C) are installed in the locations illustrated in order to support the liftgate. Please observe the following in order to prevent damage or faulty operation:
  - Do not touch, push or pull the gas struts when closing the liftgate.
  - Do not attach any plastic material, tape, etc., to the gas struts.
  - Do not tie string, etc., around the gas struts.
  - Do not hang objects on the gas struts.

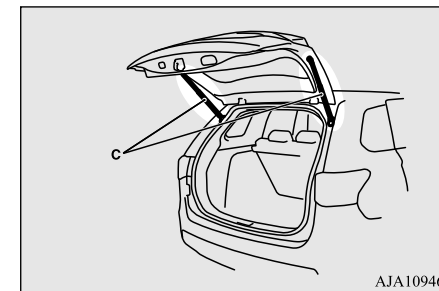

## Power liftgate (if so equipped)

### Power liftgate (if so equipped)

N00575900039

Before operating the power liftgate, unlock the power liftgate by pushing the power door lock switch or the unlock button on the F.A.S.T.-key.

**5**

Refer to “Free-hand Advanced Security Transmitter (F.A.S.T.-key)” and “Power door locks” on pages 5-4 and 5-26 respectively.

### Operating the power liftgate

N00576000040

#### ⚠ WARNING

- The luggage area was not designed for people to ride in. Do not let your children ride in or play in the luggage area. Riding or playing in the luggage area could result in a serious accident and/or injury.
- Before driving, make sure the power liftgate is securely closed.  
If you drive with the power liftgate open, exhaust gas may enter the vehicle and cause carbon monoxide poisoning.
- To avoid injury, the power liftgate should not be operated by children.

#### ⚠ WARNING

- When opening and closing the power liftgate, make sure that there are no people nearby and be careful not to hit your head or pinch your hands, neck, etc.  
Make sure the power liftgate is completely open before loading and unloading luggage.

#### ⚠ CAUTION

- Do not stand behind the exhaust pipe when loading and unloading luggage with engine running.  
The heat from the exhaust could cause burns.
- Before driving, make sure the power liftgate is securely closed. If the liftgate opens while driving, objects stored in the luggage compartment could fall out into the road.
- Do not install any accessory other than Mitsubishi Motors Genuine parts on the power liftgate. The weight of the accessory may cause faulty operation of the liftgate.
- Before closing the liftgate, make sure there is no foreign object around the striker (A). If a foreign object matter gets into the striker, it could prevent the power liftgate from closing securely.

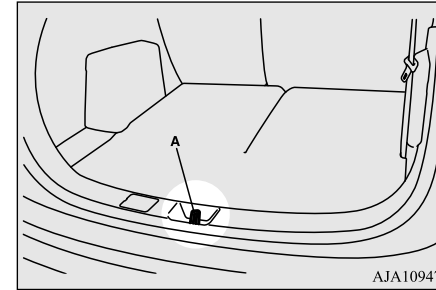

AJA109473

#### 📖 NOTE

- When opening and closing the power liftgate, do not place your hands near the arm (B) and gas struts (C).
- To prevent damage to the gas struts:
  - Do not push or pull on the gas struts.
  - Do not wrap, attach or hang anything on the gas struts.

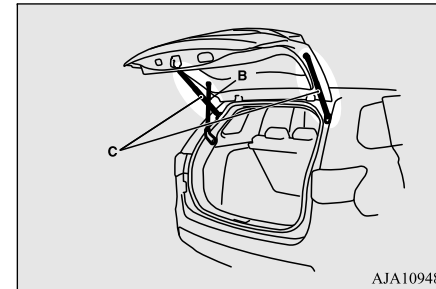

AJA109486

Power liftgate (if so equipped)

**Automatic operation**

N00576500032

When the power liftgate main switch (A) is on, the power liftgate can be operated using either the power liftgate switch on the F.A.S.T.-key, the driver's side power liftgate switch or the open/close switches on the power liftgate.  
Refer to "Operating conditions" on page 5-31.

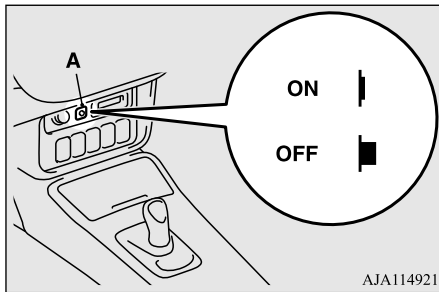

AJA114921

**WARNING**

- To avoid accidental or unintended operation of the power liftgate, turn off the power liftgate main switch when not operating the power liftgate.
- Do not turn off the power liftgate main switch while the power liftgate is opening or closing.

**CAUTION**

- Do not apply excessive force to the power liftgate when opening or closing it. Doing so could damage to the power liftgate.

**NOTE**

- Do not start the Plug-in Hybrid EV System while the power liftgate is operating. The sudden operation prevention mechanism could operate, making the power liftgate stop intermittently while it moves.
- The power liftgate cannot be opened when the 12 V starter battery is discharged or disconnected. The liftgate must be then opened using the inside liftgate release. Refer to "Inside liftgate release" on page 5-36.
- If the keyless entry system or close switch is operated when the power liftgate main switch is off, the warning buzzer sounds 4 times to notify the driver that the power liftgate cannot be operated.
- The power liftgate does not operate normally under the following conditions:
  - When parked on an incline
  - In strong winds
  - When the power liftgate is covered with snow

**NOTE**

- Repeated continuous opening and closing operation of the power liftgate will activate a built-in protection circuit and switch the power liftgate to manual operation.
- If one of the power liftgate switches is operated while the power liftgate is operating, the power liftgate will reverse and return to the full open or close position.
- If the select position is moved from "P" (PARK) position to another position while the power liftgate is operating or completely open, a warning buzzer will sound for approximately 10 seconds to notify the driver that the power liftgate is open.
- If the 12 V starter battery or fuse is replaced while the power liftgate is open, it cannot be closed automatically. In this case close the power liftgate manually.

5

**Operating conditions**

N00576100054

The power liftgate can be opened automatically when all of the following conditions are met.

<Using the F.A.S.T.-key>

- The operation mode is in OFF.
- The power liftgate is completely closed.
- The power liftgate is unlocked.

### Power liftgate (if so equipped)

<Using the driver's side power liftgate switch>

- The operation mode is in ON with the select position in the "P" (PARK) position, or the operation mode is in OFF or ACC.
- The power liftgate is completely closed.
- The power liftgate is unlocked.

5

The power liftgate can be closed automatically when all of the following conditions are met.

<Using the F.A.S.T.-key>

- The operation mode is in OFF.
- The power liftgate is completely open.
- Nothing is touching the auto reverse sensors (A) on the power liftgate.

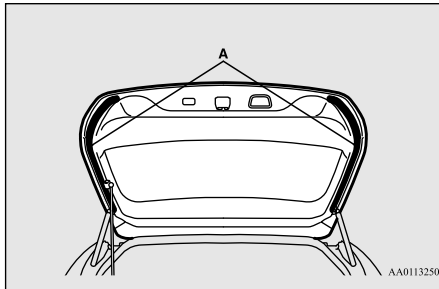

<Using the driver's side power liftgate switch or the close switch on the power liftgate>

- The operation mode is in ON with the select position in the "P" (PARK) position, or the operation mode is in OFF or ACC.
- The power liftgate is completely open.
- Nothing is touching the auto reverse sensors on the power liftgate.

### Operating the power liftgate using the F.A.S.T.-key or the driver's side power liftgate switch

After unlocking the doors and the power liftgate, the power liftgate can be operated by pressing the switch (A) of the F.A.S.T.-key or the driver's side power liftgate switch (B).

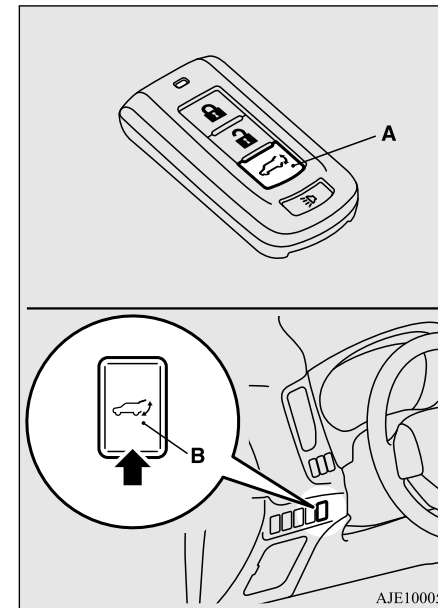

<Using the F.A.S.T.-key>



Power liftgate (if so equipped)

If the power liftgate switch is pressed twice in a row, the power liftgate operates after the warning buzzer sounds and the hazard warning flasher blinks.

The power liftgate operates as follows:

- While closed: The warning buzzer sounds and the power liftgate completely opens.
- While open: The warning buzzer sounds and the power liftgate completely closes.

If the power liftgate switch is pressed once while the power liftgate is operating, the warning buzzer sounds and the liftgate will reverse and return to the full open or closed position.

**NOTE**

- If the power liftgate switch is pressed three or more times in a row, the power liftgate may not operate normally. If this occurs, wait a short time before again pressing the power liftgate switch twice.

<Using the driver's side power liftgate switch>

If the driver's side power liftgate switch is pressed for more than 1 second, the power liftgate will operate after the buzzer sounds and the hazard warning flasher blinks.

The power liftgate operates as follows.

- While closed: The warning buzzer sounds and the power liftgate completely opens.
- While open: The warning buzzer sounds and the power liftgate completely closes.

If the driver's side power liftgate switch is pressed once while the power liftgate is operating, the warning buzzer will sound and the power liftgate will move in the direction opposite to the one in which it was operating.

**WARNING**

- When operating the power liftgate, make sure that there are no people near the power liftgate and that there is sufficient space behind and above the vehicle.

**Opening the power liftgate using the open switch**

The power liftgate can be opened by pressing the open switch (C).

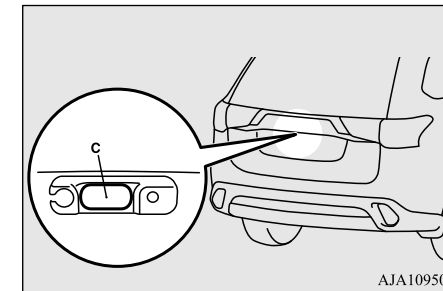

5

If the open switch is pressed while the power liftgate is operating, the warning buzzer will sound and the power liftgate will move in the direction opposite to the one in which it was operating.

**NOTE**

- When you are carrying the F.A.S.T.-key with the power liftgate is locked, the power liftgate can be opened by pressing the open switch even if the power liftgate is locked.
- For vehicles equipped with the mirror retractor switch, the outside rearview mirrors automatically extend when the power liftgate and all doors are unlocked using the liftgate open switch (C).

## Power liftgate (if so equipped)

### Closing the power liftgate using the close switch

The power liftgate can be closed by pressing the close switch (D) on the power liftgate.

5

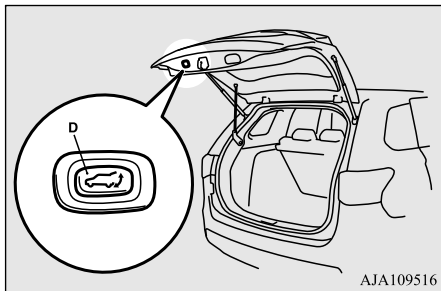

If the close switch on the power liftgate is pressed, the power liftgate will close after the warning buzzer sounds and the hazard warning flasher blinks.

If the close switch is pressed once while the power liftgate is closing, the warning buzzer sounds and the power liftgate opens.

#### NOTE

- If the close switch is again pressed once while the power liftgate is operating in the opening direction, the warning buzzer will sound once and the power liftgate will close.

### Auto reverse

N00576200039

If the auto reverse sensors (A) on either side of the power liftgate detect that something is being trapped by the closing power liftgate, the warning buzzer will sound once and the liftgate will automatically reverse direction and return to the full open position.

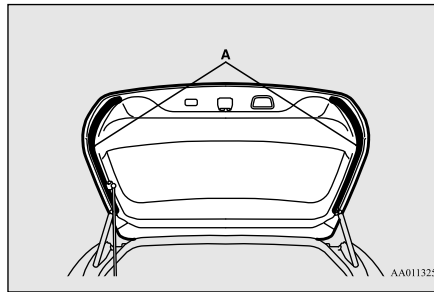

#### WARNING

- The auto reverse mechanism will not operate just before the power liftgate becomes fully closed. Therefore, be careful not to trap a hand, part of your body or an object at this time.
- When the power liftgate is closed manually, the auto reverse mechanism will not operate.

#### WARNING

- If the auto reverse mechanism has been repeatedly activated, the power liftgate may stop and then, depending on its position, may abruptly open or close. Once the power liftgate is completely closed or open, automatic operation will be resumed.

#### CAUTION

- Do not damage the auto reverse sensor, when loading or unloading luggage. If the sensor is damaged, the power liftgate will not close automatically.

### Drop prevention mechanism

After the power liftgate has opened automatically, if it is detected that the power liftgate is dropping due to factors such as accumulated snow, the power liftgate will close automatically.

A warning buzzer will sound continuously while the drop prevention mechanism is operating.

#### NOTE

- If snow has accumulated on the power liftgate, remove it before operating the power liftgate.

Power liftgate (if so equipped)

**NOTE**

- Do not install any accessory other than Mitsubishi Motors Genuine parts on the power liftgate. The drop prevention mechanism may be activated due to the weight of the accessory.
- The drop prevention mechanism could be activated if you attempt to close the liftgate manually immediately after the power liftgate has been completely opened automatically.

**Sudden operation prevention mechanism**

If the Plug-in Hybrid EV System is started while the power liftgate is operating, the power liftgate may intermittently move or stop moving to prevent the power liftgate from moving abruptly. Approximately 10 seconds after the power liftgate has fully closed or opened, power liftgate operation will again resume.

**CAUTION**

- The auto reverse will not operate while the sudden operation prevention mechanism is activated.

**Manual operation**

N00576300043

When the power liftgate main switch is off, the power liftgate can be manually opened and closed.

After unlocking the power liftgate, push the power liftgate open switch (A) and pull up the power liftgate.

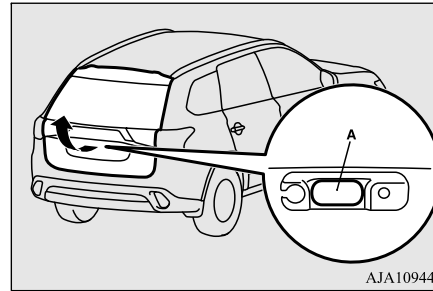

**WARNING**

- When the power liftgate is closed manually, the auto reverse mechanism will not operate even if something is trapped under the liftgate.

**CAUTION**

- Make sure there is no one around the power liftgate when opening it.

**NOTE**

- The liftgate cannot be opened if it is not raised immediately after pressing the power liftgate open switch. If this happens, raise the liftgate again after pressing the liftgate open switch.
- When the 12 V starter battery is discharged or disconnected, the power liftgate cannot be opened even manually. At that time, the liftgate can be opened only by using the inside liftgate release. Refer to “Inside liftgate release” on page 5-36.

To close the power liftgate, pull the power liftgate grip (B) downward and release it before the power liftgate is completely closed, and then gently close the power liftgate from the outside.

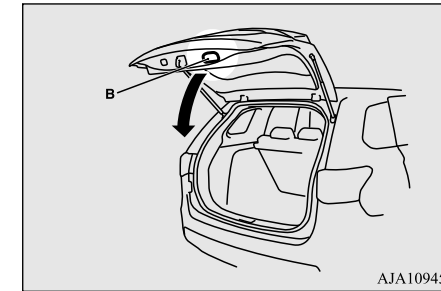

## Inside liftgate release

### ⚠ CAUTION

- The auto reverse mechanism will not operate when the power liftgate is closed manually. Therefore be especially careful not to trap a hand or finger.
- Do not fully close the power liftgate with your hand still on the power liftgate grip. Doing so could trap and injure your hand or arm.

5

## Power liftgate easy closer

N00576400031

The power liftgate easy closer is designed to help the power liftgate close securely. If the power liftgate is closed to a position where it is detected as being ajar, it closes automatically.

### ⚠ WARNING

- **Keep your hands and fingers away from the power liftgate while the power liftgate easy closer is activated. To return the power liftgate to the slightly ajar position while the power liftgate easy closer is activated, press the power liftgate open switch.**

### ⚠ CAUTION

- Do not touch the latch (A) on the inside of the power liftgate. The power liftgate easy closer could operate and catch your fingers.

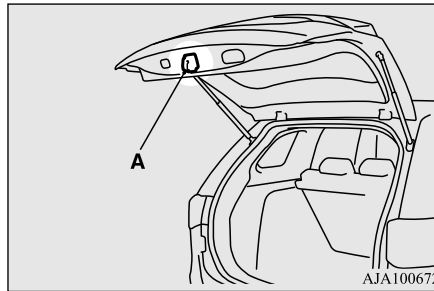

### 📖 NOTE

- The power liftgate easy closer operates even when the power liftgate main switch is OFF.
- Repeated continuous operation of the handle could activate the protection circuit and temporarily prevent the power liftgate easy closer from operating. If this occurs, wait approximately 1 minute before operating the power liftgate easy closer again.

## Inside liftgate release

N00523101130

The inside liftgate release is designed to provide a way to open the liftgate if the 12 V starter battery is dead or disconnected. The liftgate release lever (see illustration) is mounted on the liftgate.

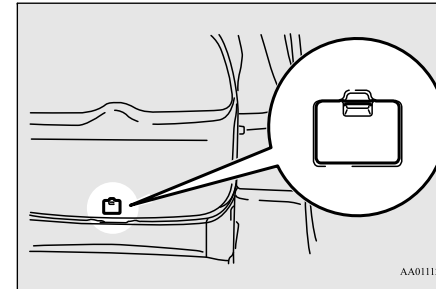

You and your family should familiarize yourselves with the location and operation of the liftgate release lever.

## To open

1. Open the lid (A) inside of the liftgate.

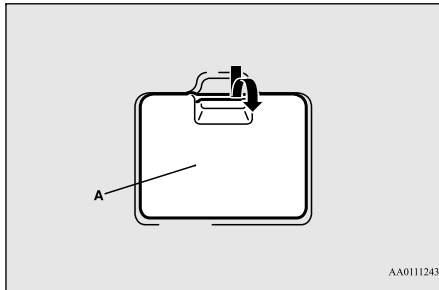

2. Move the lever (B) to unlock the liftgate.

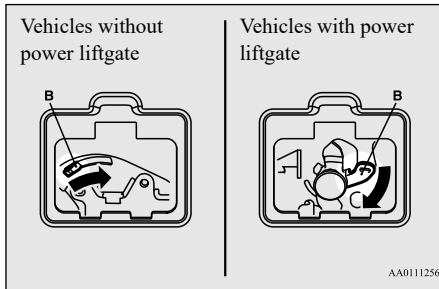

3. Push out on the liftgate to open it.

## CAUTION

- Always keep the release lever lid on the liftgate closed when driving so that your luggage cannot accidentally bump the lever and open the liftgate.

## Theft-alarm system

N00510201296

The theft-alarm system is designed to provide protection from unauthorized entry into the vehicle. This system is operated in three stages: the first is the “armed” stage, the second is the “alarm” stage, and third is the “disarmed” stage. If triggered, the system provides both audible and visual alarm signals.

## CAUTION

- Do not modify or add parts to the theft-alarm system. Doing so could cause the theft-alarm to malfunction.

## Armed stage

N00510301255

Park the vehicle and stop the engine. Arm the system as described below.

1. Put the operation mode in OFF.
2. Make sure that the engine hood is closed.

## Theft-alarm system

3. Lock all doors and the liftgate by using the keyless entry system or the F.A.S.T.-key operation.

Arm the system and leave

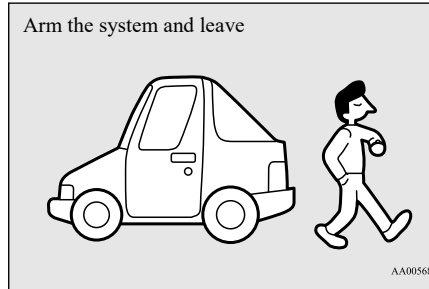

5

At this time, the theft-alarm indicator (A) in the instrument cluster flashes for confirmation.

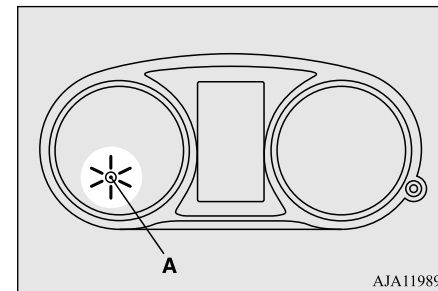

4. The system has entered the armed stage after approximately 20 seconds, when the theft-alarm indicator (A) flashing becomes slower.

## Theft-alarm system

The theft-alarm indicator (A) continues to flash while the system is in the armed stage.

### NOTE

- If the engine hood is open, the theft-alarm indicator (A) illuminates and the system cannot enter the armed stage. The system enters the armed stage approximately 20 seconds after the engine hood is closed.
- The system will be disarmed if, while the theft-alarm indicator (A) is illuminated, all doors and the liftgate are unlocked by using the keyless entry system or the F.A.S.T.-key operation.
- The system will be disarmed if, while the theft-alarm indicator is illuminated, the operation mode is put in ON.
- The system will not be armed if a door, the liftgate or the engine hood is not completely closed. If this happens, rearm the system as described above.
- The theft-alarm system can be activated when people are riding inside the vehicle or when the windows are open. To prevent accidental activation of the alarm, do not set the system to the system armed mode while people are riding in the vehicle.

5

### NOTE

- For vehicles equipped with the interior alarm sensor, if the turn signal lights do not flash after the locking and unlocking operation using the keyless entry system or the F.A.S.T.-key operation, the theft-alarm system may be malfunctioning. Have the vehicle inspected by a certified Mitsubishi EV dealer. If the answerback function (flashing of the turn signal lights by locking and unlocking the doors and the liftgate) is deactivated, the turn signal lights do not flash after the locking and unlocking operation. For information on the answerback function, refer to “Keyless entry system” on pages 5-19 and “To operate using the F.A.S.T.-key” on page 5-7.
- For vehicles equipped with the interior alarm sensor, the theft-alarm system could be activated in the following situations.
  - Using a car washer.
  - Taking the vehicle on a ferry.
  - Parking in an automated car park.
  - Leaving someone or a pet in the vehicle.
  - Leaving a window or the sunroof open.
  - Leaving an unstable object such as a stuffed toy or accessory in the vehicle.

### NOTE

- During a continuous impact or vibration by hail, thunder, etc. According to the situations, deactivate the vehicle inclination detection function and the interior intrusion detection function. Refer to “Theft-alarm system: To deactivate the vehicle inclination detection function and the interior intrusion detection function” on page 5-39.
- For vehicles equipped with the interior alarm sensor, the sensitivity of the interior intrusion detection function can be adjusted. For further details, please contact a certified Mitsubishi EV dealer.

## Alarm stage

N00510401227

The alarm will be activated if any of the following occur while the vehicle is parked and the system is armed.

- One of the doors and the liftgate is opened without using the keyless entry system or the F.A.S.T.-key operation.
- The engine hood is opened.

Also, for vehicles equipped with the interior alarm sensor, the alarm will be activated if any of the following occur.

- Attempt an unauthorized moving of the vehicle. (the vehicle inclination detection function)
- Detect a motion in the vehicle. (the interior intrusion detection function)
- Disconnect the 12 V starter battery terminal.

### Type of alarm

N00582500037

When the alarm is activated:

1. The headlights blink on and off for 3 minutes.  
After 3 minutes the headlights automatically shut off.
2. The horn (the siren for vehicles equipped with the interior alarm sensor) will sound intermittently for 3 minutes.

Horn or siren sounds!  
Headlights blink on and off!



### NOTE

- The alarm will continue to operate for 3 minutes. At the end of that period, the alarm will automatically shut off to save 12 V starter battery power. The system will then be rearmed until the proper disarming step is taken.
- The alarm will resume if unauthorized actions are taken again, even if the alarm has stopped.

### Alarm deactivation

N00582600038

The alarm can be deactivated in the following ways.

- By using the keyless entry system or the F.A.S.T.-key operation to lock or unlock the doors and liftgate.
- Put the operation mode in ON.

### To deactivate the vehicle inclination detection function and the interior intrusion detection function (vehicles equipped with the interior alarm sensor)

N00582700039

The vehicle inclination detection function and the interior intrusion detection function can

### Theft-alarm system

be deactivated when parking in automated car parks or leaving pets in the vehicle.

1. Put the operation mode in OFF.
2. Raise and hold the wiper and washer switch to the "MIST" position for approximately 3 seconds. The buzzer will sound twice and the function will be deactivated.

5

To activate the function again, raise and hold the wiper and washer switch to the "MIST" position for approximately 3 seconds. The buzzer will sound once and the function will be activated.

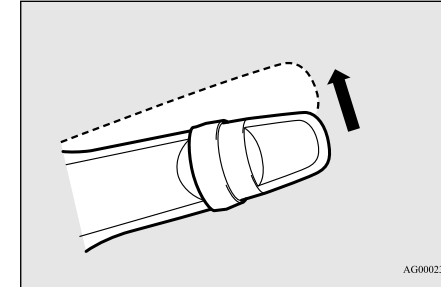

### NOTE

- The function will be activated again if the following operation is performed.
  - If the doors and the liftgate are unlocked using the keyless entry system or the F.A.S.T.-key operation.

## Power window control

### NOTE

- If the operation mode is put in ON or ACC.

### Disarmed stage

N00510501231

The system will be disarmed if the following operation is performed.

**5**

- The operation mode is put in ON.
- All doors and the liftgate are unlocked by using the keyless entry system or the F.A.S.T.-key operation.

Disarm...by using the keyless entry system or F.A.S.T.-key operation

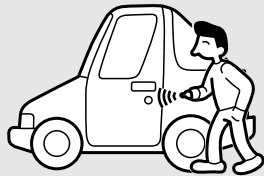

AA0070940

### NOTE

- If the UNLOCK button on the remote control transmitter, or the driver's or front passenger's door lock/unlock switch is pressed when all doors and the liftgate are closed and no door is opened within approximately 30 seconds, re-arming will automatically occur.

### NOTE

- The amount of time after unlocking until the vehicle relocks automatically can be adjusted. See a certified Mitsubishi EV dealer for details.  
On a vehicle equipped with the Smartphone-link Display Audio (SDA), the functions can be adjusted on the screen. For details, refer to a separate owner's manual.
- Once the system has been disarmed, it cannot be rearmed except by repeating the arming procedure.

### Testing the theft-alarm system

N00510601144

Use the following procedure to test the system:

1. Lower the driver's window.
2. Arm the system as explained in "Armed stage".
3. Make sure that the theft-alarm indicator comes on and flashes for approximately 20 seconds.
4. Wait a few seconds and then unlock the driver's side door by using the inside door lock knob. Open the door.
5. Make sure that the horn (the siren for vehicles equipped with the interior alarm sensor) sounds intermittently and the headlights blink when a door is opened.

6. Disarm the system by unlocking all doors and the liftgate by using the keyless entry system or the F.A.S.T.-key operation.

### Power window control

N00510801423

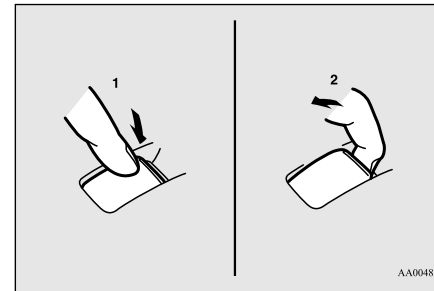

AA0048266

- 1- Open (down)
- 2- Close (up)

### NOTE

- Never try to operate the main switch and sub-switch in different directions at the same time. This will freeze the window in position.
- Operating the power windows repeatedly with the Plug-in Hybrid EV System stopped will run down the 12 V starter battery. Use the window switches only while the Plug-in Hybrid EV System is operating.



## Power window control

### **⚠ WARNING**

- Before operating the power windows, make sure that nothing can be trapped (head, hands, fingers, etc.) in the window.
- Never leave the vehicle without carrying the key.
- Never leave children or unreliable adults unattended inside the vehicle.

### Main switch

N00548701209

The main switch located on the driver's door can be used to operate all the windows. A window can be opened or closed by operating the corresponding switch. Press the switch down to open the window, and pull up the switch to close it. If the switch is fully pressed down/pulled up, the door window automatically opens/closes completely. If you want to stop the window movement, operate the switch lightly in the reverse direction.

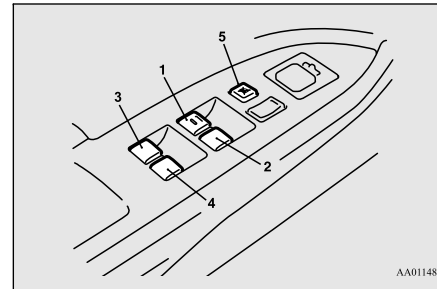

- 1- Driver's door window switch
- 2- Front passenger door window switch
- 3- Left rear door window switch
- 4- Right rear door window switch
- 5- Lock switch

### **📖 NOTE**

- If the switch is operated continuously, the power window protection function will activate and the door window may not be opened and closed automatically even if the switch is fully pressed down/pulled up. In such a case, pull up the door window switch until the window has been fully closed. You should now be able to operate the door window in a normal fashion.

**5**

### Sub switch

N00548800102

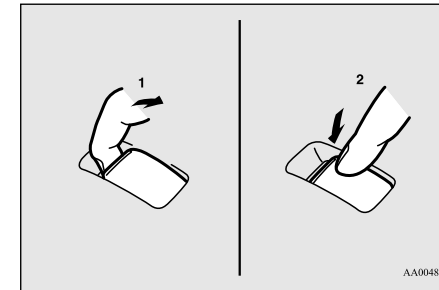

- 1- Close
- 2- Open

Each sub-switch can be used for its own passenger door window, unless the driver's window lock switch is activated.

## Power window control

### NOTE

- The rear door windows open only half-way.

### Power window timer function

N00548901168

**5** The power windows can be run up or down when the operation mode is in ON.

The door windows can be opened or closed for a 30-second period after the Plug-in Hybrid EV System is stopped. However, once the driver's door or the front passenger's door is opened, the power windows cannot be operated.

### Lock switch

N00549001209

When this switch is in the lock mode, the passenger door switches cannot be used to open or close the door windows, and the main switch will open or close only the driver's door window. To unlock the switch, push it again.

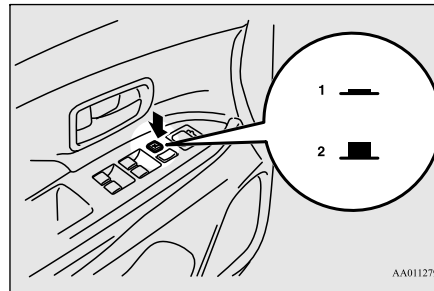

- 1- Lock
- 2- Unlock

### WARNING

- Before driving with a child in the vehicle, be sure to lock the window switch to make it inoperative. Children tampering with the switch could easily trap their hands or heads in the window.

### Safety mechanism

N00528801204

If a hand or head is trapped, for safety the door window is automatically lowered a little. After the obstruction is removed, pull up the switch again to close the door window.

### WARNING

- If the 12 V starter battery terminals are disconnected or the fuse for electric window is replaced, the safety mechanism will be canceled.  
If a hand or head got trapped, a serious injury could result.

### CAUTION

- The safety mechanism is deactivated just before the door window closes. This allows the door window to close completely. Therefore be especially careful that fingers are not trapped in the door window opening.
- The safety mechanism is deactivated while the switch is pulled up. Therefore be especially careful that fingers are not trapped in the door window opening.
- Do not deliberately trap your hands or head in order to activate the safety mechanism. Your hand or head could be trapped and personal injury could result.

## Sunroof (if so equipped)

### NOTE

- The safety mechanism can be activated if the driving conditions or other circumstances cause the door windows to be subjected to a physical shock similar to that caused by trapped hand or head.
- If the 12 V starter battery terminals are disconnected or the fuse for power window is replaced, the safety mechanism will be canceled and the door window will not automatically open/close completely.  
If the window is open, repeatedly raise appropriate window switch until that window has been fully closed.  
Following this, release the switch, raise the switch once again and hold it in this condition for at least 1 second, then release it. You should now be able to operate all windows in the normal function.

### What to do if you hear wind buffeting when driving

N00551400014

Wind buffeting can be described as the perception of pressure on the ears or a booming or rumbling sound. Your vehicle may exhibit wind buffeting when driving with one or both rear door windows down or partially opened. This is a normal occurrence that can be minimized. If the buffeting occurs with the rear door windows open, open the front door win-

dows as well as the rear door windows to minimize the condition.

### Sunroof (if so equipped)

N00511001741

The sunroof can be opened and closed with the operation mode in ON.

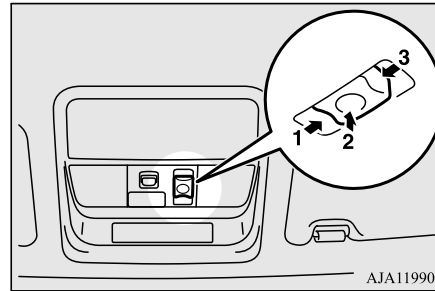

### To open

Press the switch (1), the sunroof automatically opens.

To stop the moving sunroof, press the switch.

### NOTE

- The sunroof stops just before reaching the fully open position. If the vehicle is driven with the sunroof in this position, wind buffeting is lower than with the sunroof fully open.

### To close

Press the switch (3), the sunroof automatically closes.

To stop the moving sunroof, press the switch.

### To tilt up

When the switch (2) is pressed, the rear of the sunroof raises for ventilation.

### To tilt down

Press the switch (3).

### NOTE

- Be sure to tilt down the sunroof before closing the sunshade.

5

## Sunroof (if so equipped)

### Sunroof timer function

The sunroof can be operated when the operation mode is in ON. The sunroof can be opened or closed for a 30-second period after the Plug-in Hybrid EV System is stopped. However, when the driver's door or the front passenger door is opened, the sunroof cannot be operated. Start the Plug-in Hybrid EV System again to operate.

**5**

### Safety mechanism

If a hand or head is trapped in the closing sunroof opening, the safety mechanism will cause the sunroof to re-open automatically. The opened sunroof will become operational again after a few seconds.

#### **CAUTION**

- The safety mechanism is deactivated while the switch (2) is pressed. Therefore be especially careful that fingers are not trapped in the sunroof opening.
- Do not deliberately trap your hands or head in order to activate the safety mechanism. Personal injury and malfunction of the sunroof could result.

#### **NOTE**

- The safety mechanism can be activated if the driving conditions or other circumstances cause the sunroof to be subjected to a physical shock similar to that caused by a trapped hand or head.

If the safety mechanism is activated 5 or more times consecutively, normal closing of the sunroof will be aborted.

As an emergency measure, the sunroof can be closed bit by bit until the sunroof is completely closed by repeatedly pressing the switch (2).

After that, the sunroof can be set the initialized state in the following procedure.

1. Move the sunroof in slide open position.
2. Press the tilt up switch (2) continually in 10 seconds.
3. The sunroof will be moved to tilt up position automatically bit by bit.
4. The initialize is completed when the sunroof is stopped at tilt up position.

If the sunroof does not return to normal, consult a certified Mitsubishi EV dealer.

### Sunshade

The sunshade can be opened or closed manually while the sunroof is closed.

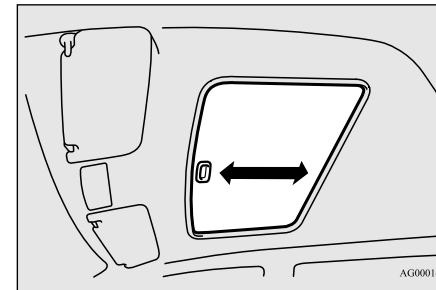

#### **WARNING**

- Do not stick your head, hands or anything else in the sunroof opening.
- Before operating the sunroof, make sure that nothing can be trapped (head, hands, fingers, etc.).
- Never leave a child unreliable adults unattended inside the vehicle.

#### **CAUTION**

- Do not attempt to close the sunshade when the sunroof is opened.
- Be careful that hands are not trapped when closing the sunshade.

## Parking brake

**NOTE**

- When leaving the vehicle unattended, be sure to close the sunroof and carry the key.
- Do not try to operate the sunroof if it is frozen closed (after snowfall or during extreme cold).
- Do not sit on or place heavy luggage on the sunroof or roof opening edge.
- Do not apply any force that may cause damage to the sunroof.
- Release the switch when the sunroof has reached a completely open or completely closed position.
- If the sunroof does not operate when the sunroof switch is operated, release the switch and check whether something is trapped by the sunroof. If nothing is trapped, have the sunroof checked at a certified Mitsubishi EV dealer.
- Be careful when tilting up the sunroof if a ski carrier or a roof carrier is installed. Depending on the model of ski carrier or roof carrier, the sunroof may contact the carrier when the sunroof is tilted up.
- Be sure to close the sunroof completely when washing the vehicle or when leaving the vehicle.
- Do not put any wax on the weatherstrip (black rubber) around the sunroof opening. If it is waxed, the weatherstrip cannot maintain a weatherproof seal with the sunroof.
- After washing the vehicle or after rain be sure to wipe off any water that is on the sunroof before operating it.

**NOTE**

- Operating the sunroof repeatedly with the Plug-in Hybrid EV System stopped will run down the 12 V starter battery. Operate the sunroof only while the Plug-in Hybrid EV System operating.

**Parking brake**

N00591500033

To park the vehicle, first bring it to a complete stop, firmly apply the parking brake, and then shift the select position to the “P” (PARK) to lock the wheels. Make sure the brake warning light is illuminated.

**Electric parking brake**

The Electric parking brake is the system that applies the parking brake by the electric motor.

**NOTE**

- You may hear an operation noise from the vehicle body when operating the Electric parking brake. This does not indicate a malfunction and the Electric parking brake is operating normally.

**NOTE**

- When the 12 V starter battery is weak or dead, the Electric parking brake cannot be applied or released. Refer to “Jump-starting the Plug-in Hybrid EV system” on page 8-2.
- You may feel the brake pedal moving when operating the Electric parking brake. This does not indicate a malfunction.

**5****To apply**

N00591600076

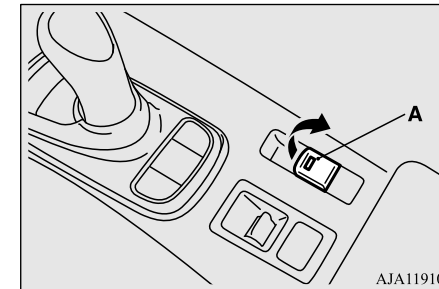

1. Stop the vehicle completely.
2. Pull up the Electric parking brake switch while depressing the brake pedal.

When the parking brake is applied, the brake warning light in the instrument cluster and the indicator light (A) on the Electric parking brake switch will come on.

## Parking brake

When parking on a hill, set the parking brake, and turn the front wheels toward the curb on a downhill, or away from the curb on an uphill.

5

### CAUTION

- Do not place any items near the Electric parking brake switch. Items may come into contact with the switch, which may unexpectedly trigger operation of the Electric parking brake.
- While the vehicle is in motion, do not apply the Electric parking brake. Doing so may cause overheating and/or premature wear of brake parts, reducing brake performance.

### NOTE

- In the following conditions, the brake warning light will illuminate for approximately 15 seconds and then go off.
  - While the Electric parking brake is applied, the operation mode of the power switch is put in OFF.
  - While the operation mode of the power switch is in OFF, the Electric parking brake switch is pulled up.

### NOTE

- If the Electric parking brake must be applied in an emergency situation, pull and hold the Electric parking brake switch to apply the Electric parking brake. At that time, the following warning display will appear in the multi-information display and a buzzer will sound, however you should continue to pull and hold the Electric parking brake switch.



- When parking on steep grades, pull up the Electric parking brake switch twice (once more after the operation is completed once). The maximum effect of the parking brake will be obtained.
- If the parking brake does not hold the vehicle stationary after the foot brake is released, contact a certified Mitsubishi EV dealer.
- When the operation mode of the power switch is other than ON, if the Electric parking brake is applied, the Electric parking brake indicator light comes on for a while.

### NOTE

- If the Electric parking brake switch is repeatedly operated in a short time, the following warning display will appear in the multi-information display and the Electric parking brake will temporarily stop working. In such case, wait for approximately 1 minute until the warning display disappears, and operate the Electric parking brake switch again.



- The brake warning light and the indicator light on the Electric parking brake switch may blink. This does not indicate a malfunction if the lights go off when/if the Electric parking brake is released.
- Depending on the situation, the Electric parking brake may be applied automatically. Refer to "Brake auto hold" on page 5-74.

## To release

N00591700051

### Manual operation

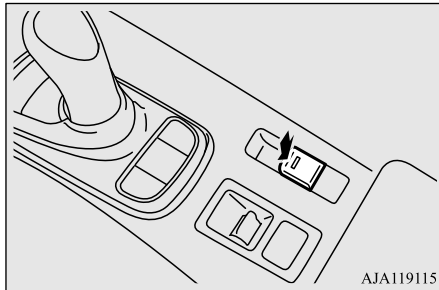

1. Make sure that the operation mode of the power switch is ON.
2. Press down the Electric parking brake switch while depressing the brake pedal.

### Automatic operation

When the accelerator pedal is depressed slowly while all of the following conditions are met, the Electric parking brake is automatically released.

- The Plug-in Hybrid EV System is operating.
- The select position is in the “D” (DRIVE) or the “R” (REVERSE) position.
- The driver’s seat belt is fastened.

When the parking brake is released, the brake warning light and the indicator light on the Electric parking brake switch go off.

Before driving, be sure that the parking brake is released and brake warning light is off.

### CAUTION

- After the Electric parking brake switch has been operated to apply or release the Electric parking brake, if the brake warning light and the indicator on the Electric parking brake switch remain blinking or the Electric parking brake warning light remain illuminated, the Electric parking brake system may be malfunctioning and the Electric parking brake may not be applied or released. Immediately park your vehicle in a safe place and contact the nearest certified Mitsubishi EV dealer.
- If a vehicle is driven without releasing the parking brake, the brake will overheat, resulting in ineffective braking and possible brake failure.
- If the brake warning light does not go off after the parking brake has been released, the brake system may be malfunctioning. Contact the nearest certified Mitsubishi EV dealer.

### CAUTION

- If the acceleration of the vehicle seems abnormally slow after the vehicle has been parked with the Electric parking brake applied in cold weather, stop the vehicle in a safe place, then apply and release the Electric parking brake. If the vehicle acceleration is still slow, contact the nearest certified Mitsubishi EV dealer.

5

### NOTE

- When the operation mode of the power switch is other than ON, the parking brake cannot be released.
- If the Electric parking brake does not automatically release, it may be released by manual operation.
- When in other than “P” (PARK) position, if you try to release the Electric parking brake without depressing the brake pedal, the warning display will appear.

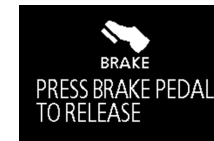

## Parking brake

5

### NOTE

- If you start driving without releasing the Electric parking brake, the warning display will appear.



- If the driver's foot contacts the accelerator pedal in the condition that the Electric parking brake can release by an automatic operation, the Electric parking brake may be released automatically.

### Warning display

N00591800065

#### Warning light



#### Warning display



If there is a malfunction in the system, the warning light will come on. In addition, the warning display appears on the information screen in the multi-information display.

5-48 Features and controls

Under normal conditions, the warning light only comes on when the operation mode of the power switch is put in ON and goes off a few seconds later.

### CAUTION

- When the Electric parking brake warning light does not illuminate or remains illuminated when the operation mode of the power switch is put in ON, or comes on while driving, the Electric parking brake may not be applied or released.

Immediately contact the nearest certified Mitsubishi EV dealer. For details, refer to "Electric parking brake warning light" on page 5-188.

When parking your vehicle while the Electric parking brake warning light is illuminated, park the vehicle on level and stable ground, shift the select position to "P" (PARK) and place chocks, blocks, or stones behind and in front of the tires to prevent the vehicle from moving.

### NOTE

- If the following warning is displayed in the information screen in the multi-information display, operate the Electric parking brake switch several times. After operating the switch, if the display disappears, there is no abnormality.





## Steering wheel height and reach adjustment

N00511501267

To adjust the steering wheel to the desired position, move the lever upward or downward while moving the steering wheel to the desired position.

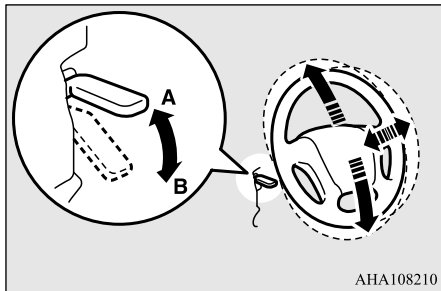

- A- Wheel lock
- B- Release

### ⚠ WARNING

- After adjusting, make sure the lock lever is secured in the locked (A) position.
- Do not attempt to adjust the steering wheel while driving. This can be dangerous.

## Inside rearview mirror

N00511601444

Adjust the inside rearview mirror only after making any seat adjustments so as to have a clear view to the rear of the vehicle.

Type 1

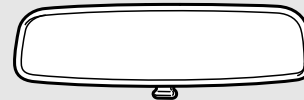

Type 2

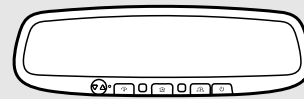

AJ3101655

### ⚠ WARNING

- Do not attempt to adjust the inside rearview mirror while driving. This can be dangerous. Be sure to adjust the mirrors before driving.

Adjust the inside mirror to maximize the view through the rear window.

## Steering wheel height and reach adjustment

### To adjust the vertical mirror position

It is possible to move the mirror up and down to adjust its position.

5

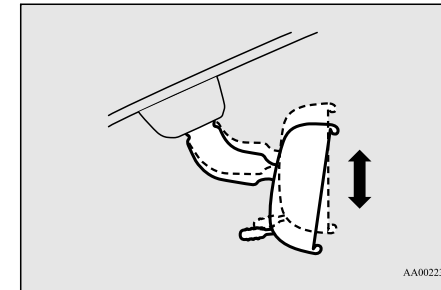

## Inside rearview mirror

### To adjust the mirror position

It is possible to move the mirror up/down and left/right to adjust its position.

5

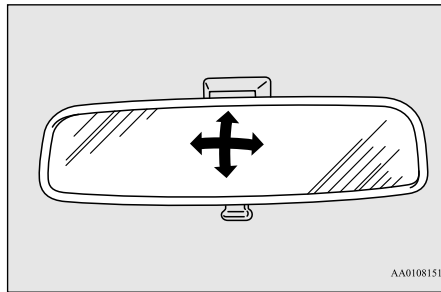

### To reduce the glare

#### Type 1

The day/night knob (A) at the bottom of the mirror can be used to adjust the mirror to reduce the glare from the headlights of vehicles behind you during night driving.

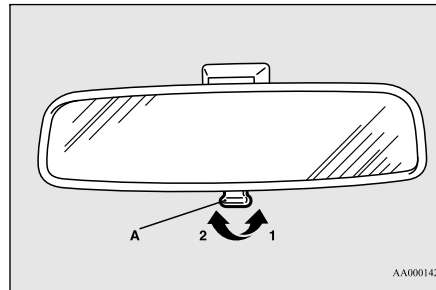

- 1- Daytime position
- 2- Night position

#### Type 2

When the headlights of the vehicles behind you are very bright, the reflection factor of the rearview mirror is automatically changed to reduce the glare.

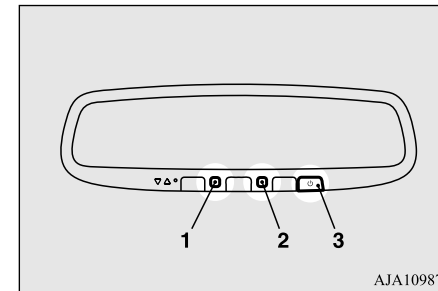

Normally, use the automatic mode. When the operation mode of the power switch is put in ON, the green indicator (1) illuminates and the reflection factor of the mirror is automatically changed.

#### NOTE

- Do not hang items on, or spray glass cleaner on the sensors (2), as reduced sensitivity could result.

Inside rearview mirror

**NOTE**

- If you want to stop automatic mode, press the switch (3) and the indicator (1) will go off.  
To return to automatic mode, press the switch again or put the operation mode of the power switch in ON after putting the operation mode in OFF.

**Electronic compass (if so equipped)**

N00589200033

**To operate the compass**

When the operation mode of the power switch is put in ON, the vehicle's directional heading (N, NE, E, SE, S, SW, W and NW) will be displayed in the visual display (A). To turn off the electronic compass, press the switch (1) for approximately 5 seconds.

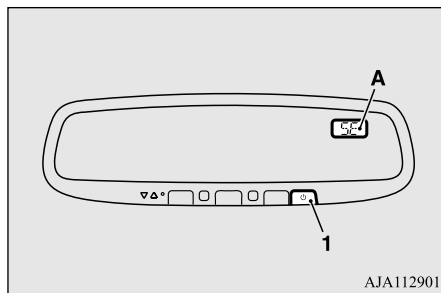

**NOTE**

- If the message ("C") is displayed in the visual display, calibrate the compass according to the instruction. Refer to "To calibrate the compass" on page 5-51.
- The electronic compass may not show the correct direction in the following places where the earth's magnetic field is disrupted. In these cases, the correct direction will be displayed once the vehicle returns to a place where the earth's magnetic field is stable.
  - Vehicle in tunnels or parked in buildings.
  - Expressways, near railroads, underneath railroad cables, or over subways
  - Near transformer stations or high voltage power lines
  - Up or down a steep hill
- Installing items such as a ski rack, antenna, or even some body repair work can cause changes to the vehicle's magnetic field. In these situations, the compass will need to be recalibrated to the vehicle's magnetic field.

**To calibrate the compass**

N00589400022

Drive the vehicle in a circle at approximately 5 mph (8 km/h) or less until the direction is displayed in the visual display.

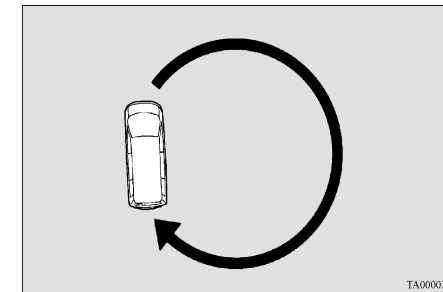

5

**NOTE**

- You can also calibrate the compass in your vehicle on your everyday routine and after several turns.

**Compass variance**

N00589500023

Under certain circumstances, as during a long distance cross-country trip, it will be necessary to adjust for compass variance. Compass variance is the difference between the earth's magnetic north and the true geographic north. If not adjusted to account for

## Outside rearview mirrors

this compass variance, your compass could give false readings.

### ■ To adjust for compass variance

N00589600024

1. Find your current geographic location and the correct corresponding zone number on the zone map.

5

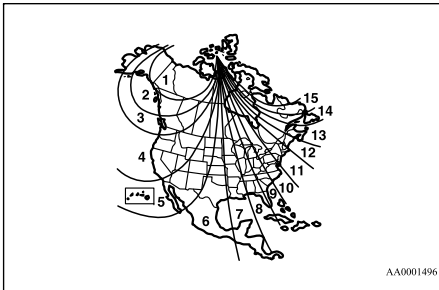

2. Press the switch (1) for approximately 7 seconds until the zone number is displayed in the visual display.

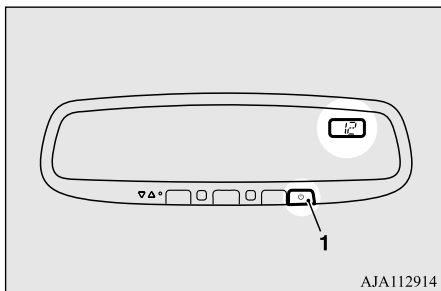

3. Press the switch (1) until the correct zone number is found and release the switch.

The visual display will show a compass direction within a few seconds.

### ⚠ CAUTION

- Adjust for compass variance when the vehicle is safety parked.

### 📖 NOTE

- The compass adjustment mode will automatically shut off, if no adjustment is made within approximately 10 seconds.
- If adjusting the zone setting did not correct the compass heading error, or if the zone is already properly set for your area, re-calibrate the compass according to the instruction. Refer to “To re-calibrate the compass” on page 5-52.

### ◆ To re-calibrate the compass

N00589700025

1. Press the switch (1) for approximately 10 seconds until the “C” is displayed in the visual display.
2. Drive the vehicle in a circle at approximately 5 mph (8 km/h) or less until the direction is displayed in the visual display.

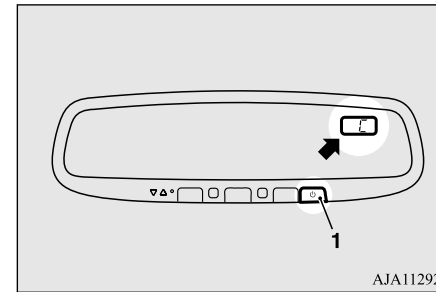

## Outside rearview mirrors

N00512201232

Adjust the outside rearview mirrors only after making any seat adjustments so as to have a clear view to the rear of the vehicle.

## Outside rearview mirrors

### **⚠ WARNING**

- Do not attempt to adjust the outside rearview mirrors while driving. This can be dangerous. Be sure to adjust the mirrors before driving.
- Your passenger's side mirror is convex. The objects you see in the mirror will look smaller and farther away than they appear in a regular flat mirror. Do not use this mirror to estimate the distance of vehicles following you when changing lanes.

### To adjust the mirror position

N00549101183

The outside rearview mirrors can be adjusted when the operation mode of the power switch is put in ON or ACC.

Move the lever (A) to the same side as the mirror you wish to adjust.

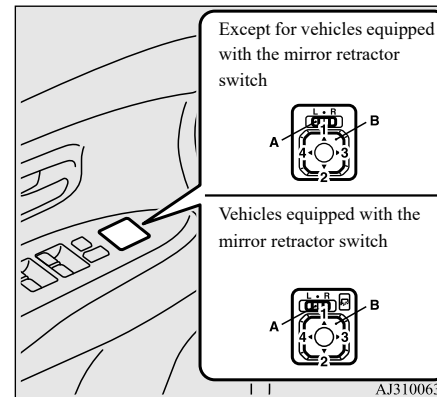

L- Left outside mirror adjustment  
R- Right outside mirror adjustment

Press the switch (B) to adjust the mirror position.

- 1- Up
- 2- Down
- 3- Right
- 4- Left

### **📖 NOTE**

- After adjusting, return the lever to the "•" (OFF) position.

### To retract the mirror

N00549201285

**5**

The outside mirror can be retracted toward the side window to prevent damage when parking in tight locations.

### Except for vehicles equipped with the mirror retractor switch

Push the mirror toward the back of the vehicle with your hand to retract it in. When extending the mirror, pull it out toward the front of the vehicle until it clicks to lock in place.

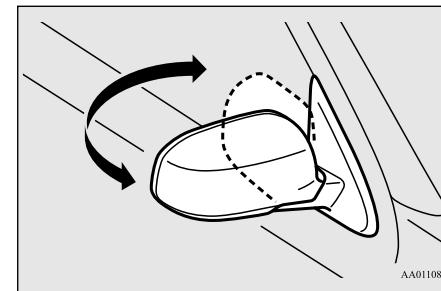

## Outside rearview mirrors

**For vehicles equipped with the mirror retractor switch**

### Retracting and extending the mirrors using the mirror retractor switch

**5**

With the operation mode of the power switch in ON or ACC, push the mirror retractor switch to retract the mirrors. Push it again to extend the mirrors to their original positions. After putting the operation mode of the power switch in OFF, it is possible to retract and extend the mirrors using the mirror retractor switch for approximately 30 seconds.

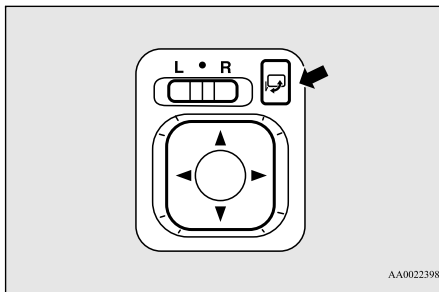

### CAUTION

- It is possible to retract and extend the mirrors by hand. After retracting a mirror using the mirror retractor switch, however, you should extend it by using the switch again, not by hand. If you extended the mirror by hand after retracting it using the switch, it would not properly lock in position. As a result, the mirror could move because of the wind or vibration while you are driving, and this may prevent the driver's rearward visibility.

### NOTE

- Be careful not to get your hands trapped while a mirror is moving.
- If you move a mirror by hand or it moves after hitting a person or object, you may not be able to return it to its original position using the mirror retractor switch. If this happens, push the mirror retractor switch to place the mirror in its retracted position and then push the switch again to return the mirror to its original position.
- When freezing has occurred and mirrors fail to operate as intended, please refrain from repeated pushing of the retractor switch as this action can result in burn-out of the mirror motor circuits.

### Retracting and extending the mirrors without using the mirror retractor switch (automatic extension function)

The mirrors automatically retract or extend when the doors and liftgate are locked or unlocked using the keyless entry system or the F.A.S.T-key operation.

Refer to “Keyless entry system” on page 5-19 or “To operate using the F.A.S.T-key” on page 5-7.

### NOTE

- Functions can be modified as stated below. Please consult a certified Mitsubishi EV dealer.
  - On vehicles equipped with the Smartphone-link Display Audio (SDA), screen operations can be used to make the adjustment. Refer to the separate owner's manual for details.
- Automatically extend when the operation mode of the power switch is put in ON with the driver's door closed, and automatically retract when the operation mode of the power switch is put in OFF with the driver's door opened.
- Automatically extend when the vehicle speed reaches approximately 19 mph (30 km/h).
- Deactivate the automatic extension function.

## Heated outside rearview mirror

N00549301358

When the rear window defogger switch is pressed with the ready indicator illuminating, the outside rearview mirrors are defogged or defrosted. Current will flow through the heater element inside the mirrors, thus clearing away frost or condensation.

The indicator light (A) will illuminate while the defogger is on.

The heater will be turned off automatically in approximately 15 to 20 minutes depending on the ambient temperature.

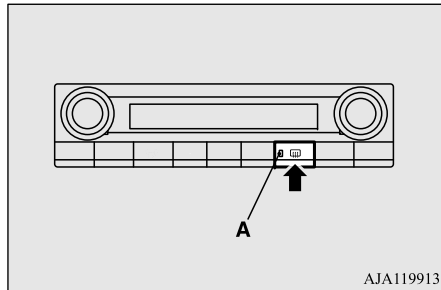

AJA119913

## NOTE

- The heated outside rearview mirror can be set so that it can turn on automatically only once if the ambient temperature becomes low, when the operation mode is put in ON. For further information, please contact a certified Mitsubishi EV dealer. On vehicles equipped with the Smartphone-link Display Audio (SDA), screen operations can be used to make the adjustment. Refer to the separate owner's manual for details.

## Electrical parking switch

## Electrical parking switch

N00586000030

To park the vehicle, bring it to a complete stop, firmly apply the parking brake, and then press the electrical parking switch. The indicator on the switch will illuminate in green and the select position indicator on the information screen will display "P".

5

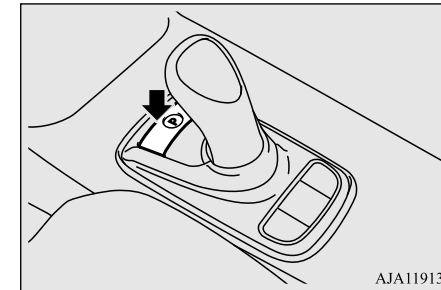

AJA119131

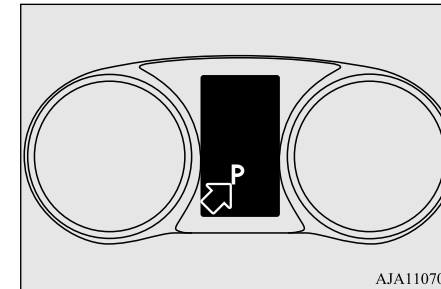

AJA110705

## Selector Lever (Joystick type)

5

### ⚠ WARNING

- Never press the electrical parking switch while the vehicle is in motion. Doing so while the vehicle is moving at low speed may also cause shifting to the “P” (PARK) position and stop the vehicle abruptly. This can damage the vehicle and/or could result in injury to occupants.
- To avoid unintended actuation of the “P” (PARK) position switch, never place an object on the switch. Unintentional shifting to the “P” (PARK) position can lead to an accident.

### ⚠ CAUTION

- If a problem occurs with the electrical parking switch system, a warning will be displayed on the information screen in the multi-information display. If this warning is displayed, have your vehicle immediately inspected by a certified Mitsubishi EV dealer.

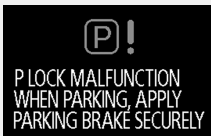

- Do not spill liquid, such as a beverage, on the electrical parking switch. This can cause the electrical parking switch to malfunction.

### 📖 NOTE

- When shifting to or from the “P” (PARK) position, you may hear an operation noise and/or feel vibration. This is normal.
- If the electrical parking switch and the selector lever are repeatedly operated in a short time period, shifting from or to the “P” (PARK) position will temporarily be restricted to protect the system. If this occurs, wait for a while and then operate the electrical parking switch or the selector lever again.

### Electrical Parking switch reminder buzzer

If the vehicle is stationary and the driver's door is opened while the select position is not in the “P” (PARK) position, a buzzer will sound to remind you to press the electrical parking switch.

## Selector Lever (Joystick type)

N00583600048

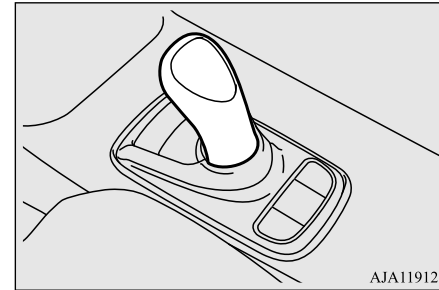



## Selector Lever (Joystick type)

## Selector lever operation

N00583700049

The selector lever always returns to its home (●) position when it is released.

The position you select with the selector lever will be illuminated on the shift position panel shown in the illustration below.

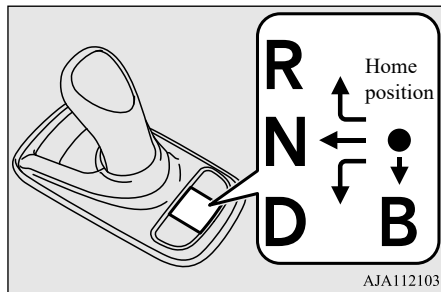

AJA112103

Move the selector lever slowly and securely in the following method.

- To select “D” (DRIVE) or “R” (REVERSE):  
Move the selector lever in the direction of the arrow.
- To select “N” (NEUTRAL):  
Move the selector lever in the direction of the arrow and hold it for a while.
- To select “B” (REGENERATIVE BRAKE):  
Move the selector lever in the direction of the arrow.

The “B” (REGENERATIVE BRAKE) position can only be selected while the shift position is in “D” (DRIVE) position. When the selector lever is moved to the “B” position, the regenerative brake force will become stronger. When the selector lever is again moved to the “B” position, the maximum regenerative brake force will be used. To return to the “D” position, use the selector lever to select the “D” position.

## NOTE

- If you move the selector lever to “B” (REGENERATIVE BRAKE) position twice too quickly, the maximum regenerative brake force may not be used.

## WARNING

- **Do not replace the selector lever knob with anything other than a Mitsubishi Motors Genuine part. In addition, do not hang, attach or place any object, pouch or bag around the selector lever. The selector lever may unintentionally move resulting in an accident.**

## WARNING

- **Before moving the selector lever to the “D” (DRIVE) or “R” (REVERSE) position from the “P” (PARK) or “N” (NEUTRAL) position, always depress the brake pedal firmly with your right foot and never depress the accelerator pedal. Failure to follow this recommendation could result in abrupt, unintended vehicle movement and/or damage to vehicle components.**

5

## NOTE

- While the Adaptive Cruise Control system (ACC) is operating, the level of the regenerative brake cannot be changed by shifting to the “B” (REGENERATIVE BRAKE) position or operating the regenerative braking level selector.
- When operating the selector lever, always make sure that the select position indicator on the multi-information display changes to the selected select position.
- If the following operation is performed, a buzzer may sound and the select position may automatically be shifted to the “N” (NEUTRAL) position.
  - If the Electrical parking switch is pressed while the vehicle is in motion.
  - If the selector lever is moved to the “R” (REVERSE) position while the vehicle is moving forward.

## Selector Lever (Joystick type)

5

### NOTE

- If the selector lever is moved to the “D” (DRIVE) position while the vehicle is moving backward.
- If the selector lever is moved to the “B” (REGENERATIVE BRAKE) position after shifted to the “R” position.
- If the following operation is performed using the selector lever, a buzzer will sound and the selector lever operation will be canceled.
  - While the select position is in the “P” position, the selector lever is moved without depressing the brake pedal.
  - While the select position is in the “P” or “N” position, the selector lever is moved to the “B” position.
  - When the operation mode of the power switch is in ON and the ready indicator is not illuminated, the selector lever is moved to the “D” (DRIVE) or “R” (REVERSE) position.
- If the selector lever is moved and held for approximately 10 seconds or longer, a buzzer will sound. The buzzer will stop when the selector lever is released.
- If the driver's door is opened while the vehicle is stationary with the shift position in any position other than “P” or the vehicle is moving slowly and the ready indicator is illuminated, a warning buzzer will sound. The buzzer will stop sounding when the driver's door is closed or the electrical parking switch is pressed to shift to the “P” position.

### Select position display

N00583800040

When the operation mode of the power switch is put in ON, the selected select position is shown on the multi-information display.

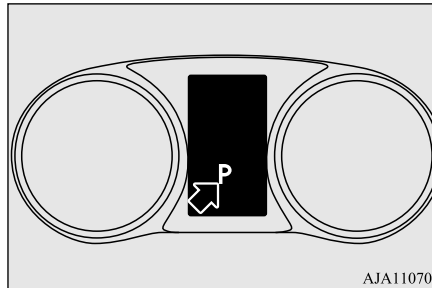

AJA110705

### NOTE

- When the “B” (REGENERATIVE BRAKE) position is selected, the regenerative braking force level is also displayed.

### Select positions

N00583900054

#### “P” PARK

This position locks the wheels to prevent the vehicle from moving.

### WARNING

- Before leaving the vehicle, make sure that the electrical parking switch has been pressed, “P” is displayed on the information display in the meter cluster and the parking brake is firmly applied to prevent the vehicle from rolling away.

#### “R” REVERSE

This position is used to back up.

#### “N” NEUTRAL

This position should only be used when the vehicle is stationary for an extended length of time while driving, such as in a traffic jam.

### WARNING

- Never move the selector lever to the “N” (NEUTRAL) position while the vehicle is moving. The regenerative braking will be lost.
- Always depress the brake pedal firmly with your right foot when shifting into or out of “N” (NEUTRAL) to avoid unintended vehicle movement.

## “D” DRIVE

This position is for normal driving.

## “B” REGENERATIVE BRAKE

Use this position when strong regenerative braking is required, such as on a steep downhill.

Two regenerative brake force levels can be selected by operating the selector lever.

Refer to “Selector lever operation” on page 5-57, “Regenerative braking” on page 3-4 and “When driving down a long hill” on page 6-5.

### ⚠ WARNING

- While driving on a slippery road, do not use the “B” (REGENERATIVE BRAKE) position. Abruptly releasing the accelerator pedal can apply strong regenerative braking causing the vehicle to skid which could result in an accident.
- If a large regenerative braking force is applied by using the selector lever or the regenerative braking level selector, the stop lights will be automatically illuminated.

### NOTE

- When the main drive lithium-ion battery level is full or nearly full, or the main drive lithium-ion battery temperature is too high or too low, the regenerative braking force may temporarily be reduced or eliminated and stronger effort may be required to operate the brakes.

### Regenerative braking force level selector (paddle type)

N00586100044

While the “D” (DRIVE) or “B” (REGENERATIVE BRAKE) position is selected, the regenerative braking force level can be changed by pulling one of the regenerative braking force paddle selectors toward you.

One of six regenerative braking force levels, B0 (without regenerative braking), or B1 (weakest level) to B5 (strongest level), can be selected.

When stronger regenerative braking is applied, more energy will be charged to the main drive lithium-ion battery.

Refer to “Regenerative braking” on Page 3-4.

### Selector Lever (Joystick type)

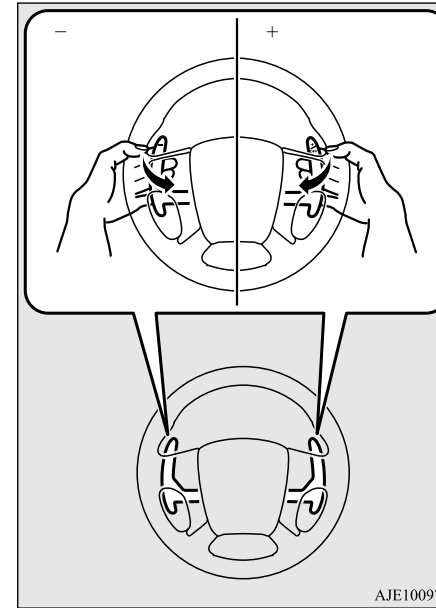

5

- To decrease the regenerative braking force: Pull the “+” selector. The regenerative braking force will become weaker by one level with each operation.
- To increase the regenerative braking force: Pull the “-” selector. The regenerative braking force will become stronger by one level with each operation.

## Selector Lever (Joystick type)

- To return to the normal regenerative braking force level (B2), pull and hold the “+” selector for two seconds or more. When the regenerative braking force is returned to the default level (B2), “D” will be displayed on the multi-information display.

5

### ⚠ WARNING

- **When a stronger regenerative braking force level is selected and the vehicle is driven on a slippery road, if the accelerator pedal is abruptly released, strong regenerative braking force will be applied which could cause the vehicle to skid and result in an accident. Always select a suitable regenerative braking force level for the road condition.**

### 📖 NOTE

- The regenerative braking force level may not change when the lateral regenerative braking force level selectors are operated at the same time.
- Repeated continuous operation of the regenerative braking force level selector will continuously change the regenerative braking force levels.

### 📖 NOTE

- If you turn on the SPORT mode, the regenerative braking force level will automatically switch to B5. After the regenerative braking force level is switched, the regenerative braking level can be adjusted by the regenerative braking level selector.
- If you turn on the cruise control while a weaker braking force level (B0 or B1) is selected, the regenerative braking force level will automatically return to the normal level (B2). Also, while the cruise control is operating, the regenerative braking force levels B0 and B1 cannot be selected. A buzzer will sound if you attempt to select these levels.
- On vehicles equipped with the Adaptive Cruise Control system (ACC), and while the Adaptive Cruise Control system (ACC) is operating, the regenerative braking force level cannot be changed from the normal level (B2). If the regenerative braking force level selector is operated, a buzzer will sound.

## Regenerative braking level display

N00586200029

When the regenerative braking force level selector is operated or the “B” (REGENERATIVE BRAKE) is selected, the selected regenerative braking force level will be shown on the multi-information display.

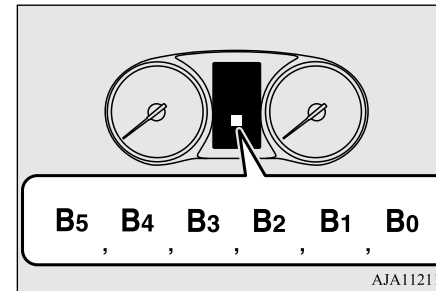

## Operation of the transaxle

N00584000036

### ⚠ CAUTION

- Before selecting a select position with the Plug-in Hybrid EV system operating and the vehicle stationary, firmly depress the brake pedal to prevent the vehicle from creeping. The vehicle will begin to move as soon as the transaxle is engaged, and the brakes should only be released when you are ready to drive away.

## S-AWC (Super-All Wheel Control) (if so equipped)

### **CAUTION**

- Always depress the brake pedal with the right foot. Using the left foot could cause delayed driver reaction or driver confusion.
- Operating the accelerator pedal while the other foot is resting on the brake pedal will affect braking efficiency and may cause premature brake pad wear.

### Waiting

For short waiting periods, such as at traffic lights, the vehicle can be left in select position and held stationary with the service brake.

For longer waiting periods with the Plug-in Hybrid EV system operating, put the select position in the “N” (NEUTRAL) position and apply the parking brake, while holding the vehicle stationary with the service brake.

Prior to moving off after having stopped the vehicle, make sure that the select position is in “D” (DRIVE) position.

### **CAUTION**

- Never hold the vehicle stationary on a hill with the accelerator. This could cause trans-axle failure. Always apply the parking brake and/or service brake to hold the vehicle.

### Parking

To park the vehicle, first bring it to a complete stop, firmly apply the parking brake, and then press the electrical parking switch.

When leaving the vehicle unattended, always stop the Plug-in Hybrid EV system and bring the key.

### S-AWC (Super-All Wheel Control) (if so equipped)

N00541301075

S-AWC is an integrated vehicle dynamics control system that helps enhance driving performance, cornering performance, and vehicle stability over a wide range of driving conditions through integrated management of the twin motor 4WD, the Active Yaw Control (AYC), the Anti-lock braking system (ABS) and the Active stability control (ASC).

### **CAUTION**

- Do not over-rely on the S-AWC. Even the S-AWC cannot prevent the natural laws of physics from acting on the vehicle. This system, like any other system, has limits and cannot help you to maintain traction and control of the vehicle in all circumstances. Reckless driving can lead to accidents. It is the driver’s responsibility to drive carefully. This means taking into account the traffic, road and environmental conditions.

5

### Twin Motor 4WD

This system improves vehicle performance and fuel economy during acceleration and deceleration using motors provided at front and rear wheels, respectively, controlling and optimizing the distribution of a drive force between the front and rear wheels.

### Active Yaw Control (AYC)

N00541501022

The AYC is a system, with a left-right differential limiting function and yaw control function, that controls the left-right driving/braking force by managing the brake.

## S-AWC (Super-All Wheel Control) (if so equipped)

### Left-right differential limiting function

The left-right differential limiting function is a function that enhances driving performance and vehicle stability by preventing idle spinning of a wheel when driving on slippery road or when the road surfaces of left and right wheels are different.

**5**

### Yaw control function

The yaw control function is a function that enhances vehicle cornering performance and vehicle stability with management of vehicle turning power (yaw moment) by controlling the braking force when the vehicle does not turn in response to steering input, such as when the steering wheel is turned quickly or when driving on slippery road.

#### **CAUTION**

- Control of the braking force does not enhance the stopping performance of the vehicle, therefore, pay careful attention to the safety of your surroundings when driving.

### S-AWC drive mode

N00598300027

Select the drive mode from the following three types to suit the driving conditions.

Drive mode	Function
NORMAL	This mode can be used on both dry and wet roads. The distribution of driving/braking torque to each wheel is automatically controlled according to the driving condition.
SNOW	This mode is for driving on slippery road surfaces, such as snow-covered roads and improves stability on a slippery road.
LOCK	This mode is for driving where maximum traction is required. This mode is suitable for driving on rough roads or driving in sand or fresh snow.

### Drive mode switch

N00598400028

When the operation mode of the power switch is in ON, operate the drive mode switch (A) to change the S-AWC drive mode.

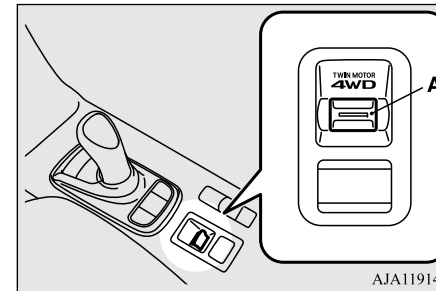

#### **CAUTION**

- Make sure that all four tires are the same specified size, type, and brand, and have no significant difference in the amount of wear for all four wheels. Otherwise, the S-AWC system may not work properly, and a EV system warning (service required) may be displayed.

## NOTE

- Even if the S-AWC drive mode is selected, after turning the operation mode of the power switch OFF and turning to ON again, the S-AWC drive mode is set to “NORMAL”.
- The drive mode can be switched while driving or stopped.

## S-AWC drive mode display

N00598500029



Example: “SNOW” mode is selected.

The currently selected drive mode is displayed on the multi-information display. In addition, when the drive mode is changed, the selected mode appears on the interrupt display screen of the information screen in the multi-information display.

The drive mode display will appear on the information screen for a few seconds, and then the original screen will return.

## S-AWC operation display

N00542501133

The S-AWC operation status can be displayed on the information screen in the multi-information display.

To display the status, press the multi-information display switch to change the information screen.

Refer to “Information screen (With the operation mode in ON)” on page 5-145.

## Display example

The S-AWC operation status is displayed.

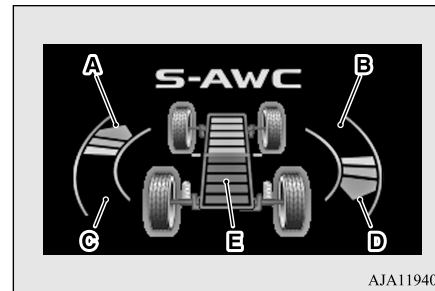

AJA119405

## Yaw control function display

The amount of the yaw moment is displayed as a bar graph.

A,D- Clockwise yaw moment about the vehicle’s center of gravity

## 4-wheel drive operation

B,C- Counterclockwise yaw moment about the vehicle’s center of gravity

## Torque distribution function display

The torque distribution between the front and rear wheels is displayed in section E of the meter as a bar graph.

If the red line is on the front, the torque of the front motor will be high, and if it is behind it the torque of the rear motor will be high.

5

## WARNING

- Always concentrate on your driving first. Keep your eyes and mind on the road. Distractions while driving can lead to an accident.

## 4-wheel drive operation

N00530601267

Your vehicle has been designed primarily for use on pavement.

But its unique 4-wheel drive system allows you to occasionally travel on unpaved roads, to campgrounds, picnic sites, and similar locations.

Not only does this ensure better handling on dry, paved roads but also permits better traction when driving on slippery, wet or snow-covered roads and when moving out of mud.

But it is not suitable for heavy off road use or towing in rough conditions.

## 4-wheel drive operation

It is particularly important to note that 4-wheel drive may not give sufficient hill climbing ability and regenerative braking on steep slopes. You should try to avoid driving on steep slopes.

Also, you must exercise caution when driving on sand and mud and when driving through water because sufficient traction may not be available in certain circumstances.

**5**

Please avoid driving the vehicle through areas where the tires may get stuck in deep sand or mud.

### WARNING

- **Do not over-rely on the 4-wheel drive vehicles. Even 4-wheel drive vehicles have limits to the system and ability to maintain control and traction. Reckless driving may lead to accidents. Always drive carefully, taking account of the road conditions.**
- **Improperly operating this vehicle on or off-pavement can cause an accident or rollover in which you and your passengers could be seriously injured or killed.**
  - Follow all instructions and guidelines in the owner's manual.
  - Keep your speed low and do not drive faster than conditions.

### NOTE

- Driving on rough roads can be hard on a vehicle. Before you leave the pavement, be sure all scheduled maintenance and service has been done, and that you have inspected your vehicle. Pay special attention to the condition of the tires, and check the tire pressures.
- Mitsubishi Motors is not responsible to the operator for any damage or injury caused or liability incurred by improper and negligent operation of a vehicle. All techniques of vehicle operation depend on the skill and experience of the operator and other participating parties. Any deviation from the recommended operating instructions above is at their own risk.
- Note that the stopping distance required of the 4-wheel drive vehicle differs very little from that of the front-wheel drive vehicle. When driving on a snow-covered road or a slippery, muddy surface, make sure that you keep a sufficient distance between your vehicle and the one ahead of you.
- The driving posture should be more upright; adjust the seat to a good position for easy steering and pedal operation. Be sure to wear the seat belt.
- After driving on rough roads, check each part of the vehicle and wash it thoroughly with water. Refer to the "Inspection and maintenance following rough road operation" section and "Vehicle care and Maintenance" sections.

### NOTE

- When moving out of mud, sand or fresh snow, pressing the accelerator pedal may not allow the power drive unit output to increase. In such situations, switching to "LOCK" with the drive mode switch and temporarily turning off the Active stability control (ASC) with the ASC OFF switch. Refer to "Operation under adverse driving conditions: If your vehicle becomes stuck in sand, mud or snow" page 8-19.

## On snowy or icy roads

Set the drive mode to "SNOW" in accordance with the road conditions, and then gradually depress the accelerator pedal for a smooth start.

### CAUTION

- Avoid sudden braking, sudden acceleration and sharp turning. Skidding occurs and control of the vehicle could be lost.

### NOTE

- The use of snow tires is recommended.
- Maintain a safe distance between vehicles, avoid sudden braking, and use regenerative braking.



## Inspection and maintenance following rough road operation

### Driving on sandy or rough roads

Set the drive mode to “LOCK” and then gradually depress the accelerator pedal for a smooth start. Keep the pressure on the accelerator pedal as constant as possible, and drive at low speed.

### Climbing/descending sharp grades

Your vehicle may not provide sufficient hill climbing ability and regenerative braking on steep slope. Avoid driving on steep slopes even though the vehicle is an 4-wheel drive vehicle.

### Inspection and maintenance following rough road operation

N00530701109

After operating the vehicle in rough road conditions, be sure to perform the following inspection and maintenance procedures:

- Check that the vehicle has not been damaged by rocks, gravel, etc.
- Carefully wash the vehicle with water.

Drive the vehicle slowly while lightly depressing the brake pedal in order to dry out the brakes. If the brakes still do not function properly, contact a certified Mitsubishi EV dealer as soon as possible to have the brakes checked.

- Remove the insects, dried grass, etc. clogging the radiator core.
- Check the inside of the vehicle. If water entry is found, dry the carpet etc.
- Inspect the headlights. If water is in the headlight housing, have it drained at a certified Mitsubishi EV dealer.

### Cautions on the handling of 4-wheel drive vehicles

N00530801243

### Tires and wheels

Since the driving torque can be applied to the four wheels, the driving performance of the vehicle when operating in 4-wheel drive is greatly affected by the condition of the tires.

Pay close attention to the tires.

- Install only the specified tires on all wheels. Refer to “Tires and wheels” on page 11-8.

- Be sure all four tires and wheels are the same size and type.

When it is necessary to replace any of the tires or wheels, replace all four.

- All tires should be rotated before the wear difference between the front and rear tires is recognizable.

Good vehicle performance cannot be expected if there is a difference in wear between tires. Refer to “Tire rotation” on page 9-19.

- Check the tire inflation pressure regularly.

### CAUTION

- Always use tires of the same size, type, and brand that have no wear differences. Using tires of different size, type, brands or degree of wear, will increase the differential oil temperature and result in possible damage to the driving system. Further, the drive train will be subject to excessive loading, possibly leading to oil leakage, component seizure, or other serious failures.

5

## EV switch

### Towing

5

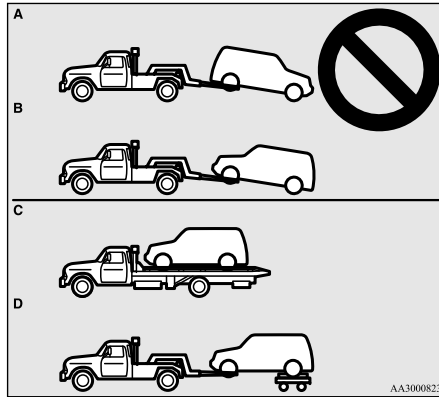

### CAUTION

- Do not tow 4-wheel drive vehicles with the front or rear wheels on the ground (Type A or Type B) as illustrated. This could result in damage to the drivetrain, or unstable towing. If you tow 4-wheel drive vehicles, use Type C or Type D equipment.

### Jacking up a 4-wheel drive vehicle

### WARNING

- While jacking up the vehicle;

### WARNING

- Do not turn on the Plug-in Hybrid EV system.
- Do not turn the jacked-up wheel. The tire on the ground may turn and the vehicle may roll off the jack.
- Do not touch the high voltage area. Doing so can result in electrocution and serious injury or death.

### EV switch

N00591900066

To drive the vehicle without starting the engine as much as possible, the EV priority mode can be used.

This mode helps drive the vehicle at a place needed for concern of noises and exhaust gas emissions, such as residential areas etc.

To switch to the EV priority mode, press the EV switch with operation mode of the power switch in ON.

If the EV switch is pressed, you can drive the vehicle by using only the EV drive mode as much as possible, even if the accelerator pedal is roughly depressed.

To cancel the EV priority mode, press the EV switch again.

When the operation mode of the power switch is put in OFF, the EV priority mode will be canceled.

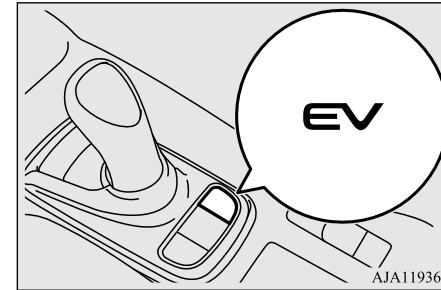

AJA119362

When switching to the EV priority mode, a screen showing the EV priority mode is displayed on the information screen in the multi-information display.

The EV priority mode indication on the upper left of the screen also indicates the engine operating state. When the engine is not running, it is displayed in blue, and when the engine is running, it is displayed in gray.

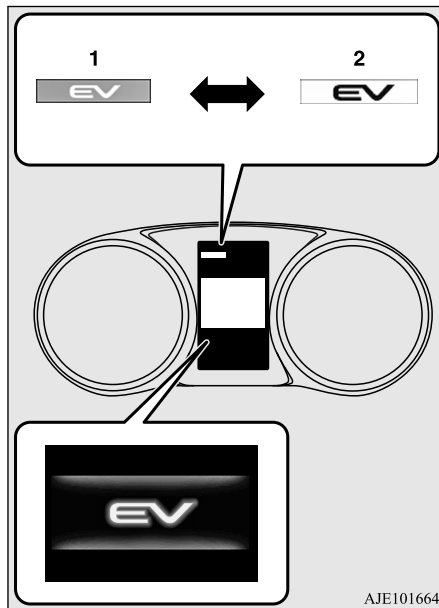

- 1: Engine is not running (blue)
- 2: Engine is running (gray)

### NOTE

- While driving the vehicle in EV priority mode, if the engine automatically starts while the vehicle is accelerating, the vehicle may accelerate more quickly.
- In the following conditions, the EV priority mode cannot be used even if the EV switch is pressed, a buzzer will sound and the message will appear in the multi-information display.
- When the remaining power in the main drive lithium-ion battery is low. Charge the main drive lithium-ion battery.



- When the cruise control or the Adaptive Cruise Control system (ACC) is operating.



If you want to use the EV priority mode, cancel the cruise control or the ACC.

- When the main drive lithium-ion battery temperature is too cold.



### NOTE

- When using the EV priority mode is limited to protect the Plug-in Hybrid EV System.



- While the following message is displayed in the multi-information display, the EV priority mode cannot be used even if the EV switch is pressed, a buzzer will sound.



- In any of the situations listed below, the EV priority mode will be automatically canceled and the message will appear in the multi-information display.

- When the remaining power in the main drive lithium-ion battery becomes low. Charge the main drive lithium-ion battery.



## SAVE/CHARGE mode switch

5

### NOTE

- When the vehicle speed of the cruise control or the ACC is set.



If you want to use the EV priority mode, cancel the cruise control or the ACC.

- When the main drive lithium-ion battery temperature becomes cold.



- When the protecting device of the Plug-in Hybrid EV System is operated.



- When the SAVE/CHARGE mode switch or the SPORT mode switch is pressed on while driving in the EV priority mode, the mode changes to the selected mode. If the EV switch is pressed, the mode is returned to the EV priority mode. However, the mode may not return to the EV priority mode depending on the remaining power in the main drive lithium-ion battery.

### NOTE

- In any of the situations listed below, the EV priority mode continues even if the engine is automatically started.
  - When the accelerator pedal is fully depressed.
  - When the vehicle speed is over 80 mph (130 km/h).
  - When the defogger switch is pressed.
- If the ambient temperature is low, the engine may start for heating when the Plug-in Hybrid EV system is started with air conditioner performed. If you want to stop the engine running, select the EV priority mode with the operation mode of the power switch in ON before starting the Plug-in Hybrid EV system.
- In the EV priority mode, the accelerator pedal response may be negative even if the accelerator pedal is depressed or released.
- The motor output in the EV priority mode may decrease due to the deteriorated main drive lithium-ion battery or the ambient temperature falls. In such a case, start the engine by canceling the EV priority mode to secure the motor output.

### SAVE/CHARGE mode switch

N00597900026

The battery save mode or the battery charge mode can be used by pressing the

SAVE/CHARGE mode switch while the operation mode of the power switch is in ON. If the SAVE/CHARGE mode switch is pressed, you can change the mode in the order of SAVE, CHARGE, OFF, SAVE.

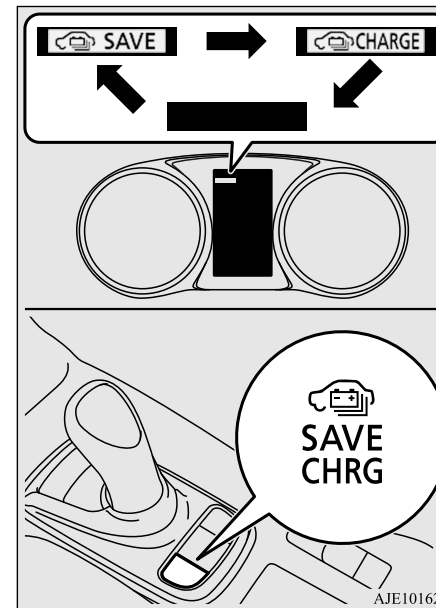

## Battery save mode

N00598000024

To save the remaining power in the main drive lithium-ion battery while driving, the battery save mode can be used. This mode helps preserve the electrical power in the main drive lithium-ion battery for later use, such as in a residential area, or to use at your destination. The battery save mode can also be used to reduce electric power consumption from the main drive lithium-ion battery during high-speed driving.

When the battery save mode is activated, the engine will start in order to preserve the remaining power of the main drive lithium-ion battery and the vehicle will operate in the series hybrid mode or the parallel hybrid mode depending on the remaining power in the main drive lithium-ion battery.

To cancel battery save mode, press the SAVE/CHARGE mode switch twice.

When the operation mode of the power switch is put in OFF, the battery save mode will be canceled.

If the battery save mode is activated, the following image is displayed on the information screen in the multi-information display.

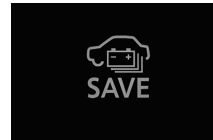

### NOTE

- The engine may stop when the vehicle stops or is running.
- Even if the battery save mode is selected, the engine may not start depending on the condition of the remaining main drive lithium-ion battery capacity or the Plug-in Hybrid EV system control.
- In the following conditions, the battery save mode cannot be used even if the battery save mode is selected, a buzzer will sound and the message will appear in the multi-information display.
  - When the engine coolant temperature is high.
  - When the remaining fuel quantity is low.



## SAVE/CHARGE mode switch

### NOTE

- In any of the situations listed below, the battery save mode will be automatically canceled and the message will appear in the multi-information display.
  - When the engine coolant temperature becomes high.
  - When the remaining fuel quantity becomes low.



- When one of the following switches is pressed while driving in the battery save mode, the mode changes to the selected mode.
    - SAVE/CHARGE mode switch
    - EV switch
    - SPORT mode switch
- Refer to “Battery charge mode” on page 5-69, “EV switch” on page 5-66 or “SPORT mode switch” on page 5-71.
- If the SAVE/CHARGE mode switch is pressed once, the mode is returned to the battery save mode.

5

## Battery charge mode

N00598100025

To charge the main drive lithium-ion battery while driving, the battery charge mode can be

## SAVE/CHARGE mode switch

used. It is recommended to use this mode before driving up long hills or mountain roads.

When the battery charge mode is activated, the engine will start to charge the main drive lithium-ion battery to nearly full.

To cancel the battery charge mode, press the SAVE/CHARGE mode switch once.

**5**

When the operation mode of the power switch is put in OFF, the battery charge mode will be canceled.

If the battery charge mode is activated, the following image is displayed on the information screen in the multi-information display.



### WARNING

- Before leaving the vehicle, be sure that the operation mode of the power switch is put in OFF. Refer to “Parking” on page 6-6.
- The engine can start at any time when the battery charge mode is activated.

### WARNING

- Never use the battery charge mode in a closed or poorly ventilated area, such as in a garage, or an area surrounded by snow banks. Carbon monoxide gas, which is odorless and extremely poisonous, could build up and cause serious injury or death.
- Use the battery charge mode only in a well-ventilated and open area.
- Never use the battery charge mode where combustible materials such as dry grass or leaves can come in contact with a hot exhaust, since a fire could occur.

### CAUTION

- While the battery charge mode is activated, do not cover the front of the vehicle with anything including a car cover. Doing so could cause the engine to overheat.

### NOTE

- Even if the battery charge mode is selected, the engine may not start depending on the condition of the remaining main drive lithium-ion battery capacity or the Plug-in Hybrid EV system control.
- In the following conditions, the battery charge mode cannot be used even if the battery charge mode is selected, a buzzer will sound and the message will appear in the multi-information display.

### NOTE

- When the engine coolant temperature is high.
- When the remaining fuel quantity is low.



- In any of the situations listed below, the battery charge mode will be automatically canceled and the message will appear in the multi-information display.
  - When the engine coolant temperature becomes high.
  - When the remaining fuel quantity becomes low.



- When driving a continuous uphill road with 4 % gradient or more at a speed of 62 mph (100 km/h) or higher, it is recommended to activate the battery charge mode at least 20 minutes before reaching the uphill road. Depending on the road and/or vehicle condition, it may not be possible to maintain a high speed.

## SPORT mode switch

**NOTE**

- At high ambient temperatures, even if the battery charge mode is activated for a prolonged time, the main drive lithium-ion battery may not charge.
- The charging time close to full charge of the main drive lithium-ion battery becomes longer depending on the condition of the main drive lithium-ion battery, a driving condition or a environment.
- The engine may stop near full charge.
- Using battery charge mode will increase fuel consumption.
- Laws in some communities may prohibit leaving the engine running while the vehicle is stationary. Before using the battery charge mode while the vehicle is stationary, check local regulations.
- Check the remaining fuel level while the battery charge mode is activated, since the fuel will be consumed.
- When the EV switch or the SPORT mode switch is pressed while driving in the battery charge mode, the mode changes to the selected mode.  
Refer to “EV switch” on page 5-66 or “SPORT mode switch” on page 5-71.  
If the SAVE/CHARGE mode switch is pressed twice, the mode is returned to the battery charge mode.

**SPORT mode switch**

N00598200026

To drive powerfully and sporty on mountain roads and uphill slope, the SPORT mode can be used.

Quick acceleration in response to operation of the accelerator pedal and quick deceleration by strong regenerative braking force are possible.

To switch to the SPORT mode, press the SPORT mode switch while the READY indicator is on.

To cancel the sport mode, press the switch again.

When the operation mode of the power switch is put in OFF, the SPORT mode will be canceled.

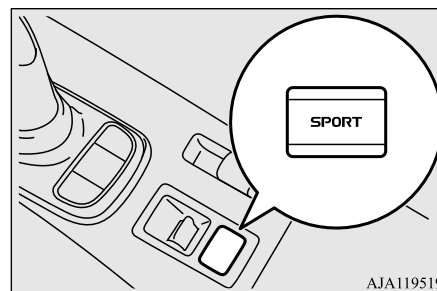

AJA119519

If the SPORT mode is activated, the following display appears on the information screen in the multi-information display.



5

**WARNING**

- If a large regenerative braking force is applied, the stop lights will be automatically illuminated.

**NOTE**

- When SPORT mode is selected, the engine will start frequently, even if there is a large amount of remaining power in the main drive lithium-ion battery. Also, since the response to the operation of the accelerator pedal will improve, you may feel a shock if you depress the accelerator pedal as usual.
- When the SPORT mode is selected, the regenerative braking force level automatically switches to B5. After switching, you can change to your desired regenerative braking force level with the regenerative braking force level selector.  
Refer to “Regenerative braking level selector (paddle type)” on page 5-59.

## Acoustic vehicle alerting system (AVAS)

5

### NOTE

- When you select the SPORT mode in the following situations, the large regenerative braking force may temporarily be reduced or eliminated.
  - When the main drive lithium-ion battery temperature is high or low.
  - When the main drive lithium-ion battery level is full or nearly full.
- If you turn on the cruise control or the Adaptive Cruise Control System (ACC) while driving in the SPORT mode, the regenerative braking force level will be “D” (B2). When the SPORT mode is returned by canceling the cruise control or the ACC, the regenerative braking force level returns to B5.
- When the remaining fuel level is low, the SPORT mode cannot be used even if the SPORT mode switch is pressed.

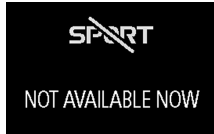

If you want to use the SPORT mode, refuel the vehicle.

### NOTE

- While the following message is displayed in the multi-information display, the SPORT mode cannot be used even if the SPORT mode switch is pressed, a buzzer will sound.



- When the remaining fuel level becomes low, the SPORT mode will be automatically canceled and the message will appear in the multi-information display.



If you want to use the SPORT mode, refuel the vehicle.

- When the following switch is turned on while driving in the SPORT mode, the mode changes to the selected mode.
  - EV switch
  - SAVE/CHARGE mode switch
  - Drive mode switch
  - ECO mode switch

## Acoustic vehicle alerting system (AVAS)

N00571901041

While driving at low speeds, such as in parking lots, the acoustic vehicle alerting system (AVAS) alerts people who may not hear your vehicle approaching.

The system sounds when the vehicle speed is approximately 22 mph (35 km/h) or less.

The system will not operate under the following conditions:

- When the vehicle speed is approximately 22 mph (35 km/h) or more.
- When the select position is in the “P” (PARK) position.
- When the engine is running.

### WARNING

- Always pay special attention to pedestrians. Even if the acoustic vehicle alerting system (AVAS) sounds, pedestrians may not notice your vehicle.



Under normal conditions, the indicator light in the instrument cluster illuminates when the operation mode of the power switch is put in ON and goes off a few seconds later. Always confirm the indicator light goes off before driving.

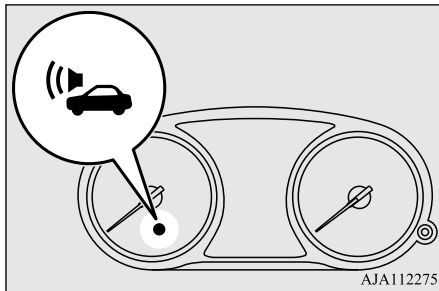

#### NOTE

- If the indicator light blinks, the operation mode of the power switch is put in OFF, and the operation mode is put in ON once again. It is not a malfunction if the indicator light goes off. If the indicator light blinks again, however, have the vehicle inspected at a certified Mitsubishi EV dealer as soon as possible.

## Service brake

N00517501315

### Brake pedal

Overuse of the brake can cause weakening, resulting in poor brake response and premature wear of the brake pads. When driving down a long or steep hill, use regenerative braking.

#### WARNING

- **Do not leave any objects near the brake pedal or let a floor mat slide under it; doing so could prevent the full pedal stroke that would be necessary in an emergency. Make sure that the pedal can be operated freely at all times. Make sure the floor mat is securely held in place.**

#### CAUTION

- It is important not to drive the vehicle with your foot resting on the brake pedal when braking is not required. This practice can result in very high brake temperatures, premature lining wear, and possible damage to the brakes.

## Service brake

### Power brakes

N00517601459

Your vehicle is equipped with power brakes for more braking force with less brake pedal effort.

Your brakes are designed to operate at full capacity, even if the power assist is not being used.

If the power assist is not being used, the effort needed to press the brake pedal is greater.

If you should lose the power assist for some reason, the brakes will still work.

If the power brake unit or either of the two brake hydraulic systems stops working properly, the rest of the brake system will still work, but the vehicle will not slow down as quickly.

You will know this has happened if you find you need to press the brake down farther, or harder when slowing down or stopping, or if the brake warning light and the warning display in the multi-information display come on.

5

## Brake auto hold

5

### WARNING

- Never coast downhill with the operation mode of the power switch in OFF. Make sure that the ready indicator is illuminated whenever your vehicle is in motion. If you put the operation mode in OFF while driving, the power brake booster will stop working and your brakes will not work as well.
- If the power assist is lost or if either brake hydraulic system stops working properly, take your vehicle to a certified Mitsubishi EV dealer immediately.

### NOTE

- At times, you may hear the brake electric vacuum pump for the power brakes operating when the ready indicator illuminates or the brake pedal is depressed. This sound is normal and does not indicate a problem.

## Brake pad wear alarm

N00550701134

The disc brakes have an alarm that makes a metallic squeal when the brake pads have worn down enough to need service. If you hear this sound, have the brake pads replaced at a certified Mitsubishi EV dealer.

### WARNING

- Driving with worn brake pads will make it harder to stop, and can cause an accident.

## Brake auto hold

N00592000107

When the vehicle is stopped at traffic lights etc., the vehicle can be held stationary with the brake auto hold system even if you release your foot from the brake pedal. When the accelerator pedal is depressed, the brakes are released.

### WARNING

- Do not overly rely on the brake auto hold system. On steep slope, depress the brake pedal firmly because the system may not hold the vehicle stationary.
- Never leave the vehicle while it is being stopped by the brake auto hold system. When leaving the vehicle, apply the parking brake and shift the select position to the "P" (PARK) position.
- Do not use brake auto hold system when driving on slippery roads. The system may not hold the vehicle stationary and could result in an accident.

### NOTE

- While operating the brake auto hold system, you may hear an operation noise to increase braking force when the system detected the movement of the vehicle. This does not indicate a malfunction.

## How to use brake auto hold

### To turn on brake auto hold

If the brake auto hold switch is pressed while all of the following conditions are met, the system will change to the standby state and the indicator light (A) on the switch comes on.

- The operation mode of the power switch is in ON.
- The driver's seat belt is fastened.
- The driver's door is closed.

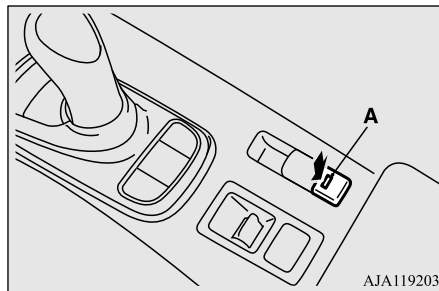

### NOTE

- When the brake auto hold system cannot be used, a buzzer will sound and the following warning will appear on the information screen in the multi-information display.

### NOTE

- If this warning appears, confirm that all of the conditions for system operation are met and that there is no malfunction in the system.

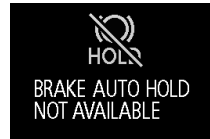

- If this warning appears, fasten the driver's seat belt.



- If any of the following occur while the system is standby state, the brake auto hold system will be turned off automatically and the indicator light on the switch goes off.

A buzzer will sound and the message will appear on the information screen in the multi-information display.

- When the driver's seat belt is unfastened.
- When the driver's door is opened.
- When there is a malfunction in the system



### NOTE

- If keeping pressing the brake auto hold switch after setting the brake auto hold to ON (stand by), the brake auto hold will return to OFF as a protection function is operated.

After returning to OFF, the brake auto hold will not be switched to ON (Stand by) even if the brake auto hold switch is pressed. To set the brake auto hold to ON, restart the Plug-in Hybrid EV system and press the brake auto hold switch again.

5

## Brake auto hold

### To activate brake auto hold

When the vehicle is stopped by depressing the brake pedal with the select position in any position other than “P” (PARK) or “R” (REVERSE), the brake auto hold activates and the vehicle will be held stationary.

**5**

The brake auto hold indicator light in the instrument cluster will come on while the system activates.

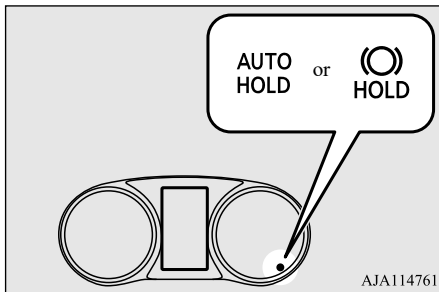

### CAUTION

- Release the brake pedal only after the brake auto hold indicator light has illuminated.

### NOTE

- In the following situations, the brake auto hold system may not operate temporarily.
  - The vehicle is stopped on a slippery road.

### NOTE

- The vehicle was stopped while the steering wheel was turned all the way to the left or right.
- The vehicle is being turned on a parking lot turntable.

If this occurs, the brake auto hold system will return to the normal operation if you depress the accelerator pedal and the vehicle starts moving again.

- If the following operation is performed, the brake auto hold will be deactivated and the brake auto hold indicator light in the instrument cluster goes off.
  - When shifting the select position to the “P” (PARK) or “R” (REVERSE) position with depressing the brake pedal.
  - When the Electric parking brake is applied by using the Electric parking brake switch.
- While the vehicle is held stationary with the brake auto hold system, the Electric parking brake will be automatically applied under the following conditions, and a buzzer will sound and the message will appear on the information screen in the multi-information display.
  - After approximately 10 minutes has elapsed with applying the brake auto hold system.
  - When the driver’s seat belt is unfastened.
  - When the driver’s door is opened.
  - When the operation mode of the power switch is put in OFF.

### NOTE

- When the system detects the vehicle sliding down a slope.



If the Electric parking brake cannot be applied automatically due to the system malfunction, the message will appear on the information screen in the multi-information display. Depress the brake pedal.

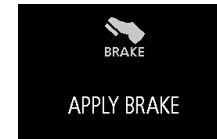

### To start the vehicle

Depress the acceleration pedal with the select position in any position other than “P” (PARK) or “N” (NEUTRAL).

The brakes are released, and the brake auto hold indicator light in the instrument cluster will go off.

## Hill start assist

**To turn off brake auto hold**

Press the brake auto hold switch to turn off the brake auto hold. The indicator light on the switch goes off.

If you want to turn off the system while the brake auto hold indicator light is illuminated, press the switch with depressing the brake pedal.

**NOTE**

- If the brake auto hold system is turned off without the brake pedal being depressed, a buzzer will sound and the message will appear on the information screen in the multi-information display.

**Hill start assist**

N00562601101

The hill start assist makes it easy to start off on a steep uphill slope by preventing the vehicle from moving backwards. It keeps the braking force for approximately 2 second when you move your foot from the brake pedal to the accelerator pedal.

**CAUTION**

- Do not overly rely on the hill start assist to prevent backwards movement of the vehicle. Under certain circumstances, even when hill start assist is activated, the vehicle may move backwards if the brake pedal is not sufficiently depressed, if the vehicle is heavily loaded, or if the road is very steep or slippery.
- The hill start assist is not designed to keep the vehicle stopped in place on uphill slopes for more than 2 seconds.
- When facing uphill, do not rely on using the hill start assist to maintain a stopped position as an alternative to depressing the brake pedal. Doing so could cause an accident.
- Do not put the operation mode of the power switch in OFF or ACC while the hill start assist is operating. The hill start assist could stop operating, which could result in an accident.

**To operate**

N00562701102

1. Stop the vehicle completely using the brake pedal.
2. Release the brake pedal and the hill start assist will maintain the braking force applied while stopped for approximately 2 seconds.

3. Depress the accelerator pedal and the hill start assist will gradually decrease the braking force as the vehicle starts moving.

**NOTE**

- The hill start assist is activated when all of the following conditions are met.
  - The Plug-in Hybrid EV System is operating. (The hill start assist will not be activated while the Plug-in Hybrid EV System is starting or immediately after the Plug-in Hybrid EV System is started.)
  - The select position is in any position other than "P" (PARK) or "N" (NEUTRAL).
  - The vehicle is completely stationary, with the brake pedal depressed.
  - The parking brake is released.
- The hill start assist will not operate if the accelerator pedal is depressed before the brake pedal is released.
- The hill start assist also operates when reversing on an uphill slope.

**5****Warning display**

N00562801116

If an abnormal condition occurs in the system, the following display/indicator will turn on.

## Brake assist system



### Warning display

5



### CAUTION

- If the warning is displayed, the hill start assist will not operate. Start off carefully.
- Park your vehicle in a safe place and stop the Plug-in Hybrid EV System. Restart the Plug-in Hybrid EV System and check whether the indicator/display goes out, in which case the hill start assist is again working normally. If they remain displayed or reappear frequently, it is not necessary to stop the vehicle immediately, but the vehicle should be inspected by a certified Mitsubishi EV dealer as soon as possible.

## Brake assist system

N00567301129

The brake assist system is a device assisting drivers who cannot depress the brake pedal firmly such as in emergency stop situations and provides greater braking force.

### 5-78 Features and controls

If the brake pedal is depressed suddenly, the brakes will be applied with more force than usual.

### CAUTION

- The brake assist system is not a device designed to exercise braking force greater than its capacity. Make sure to always keep a sufficient distance between your vehicle and a vehicle in front of you without relying too much on the brake assist system.

### NOTE

- Once the brake assist system is operational, it maintains great braking force even if the brake pedal is lightly released. To stop its operation, completely remove your foot from the brake pedal.
- The brake assist system may become operational when the brake pedal is fully depressed even if it has not been depressed suddenly.
- When the brake assist system is in use while driving, you may feel as if the depressed brake pedal is soft, the pedal moves in small motions in conjunction with the operation noise, or the vehicle body and the steering wheel vibrate. This occurs when the brake assist system is operating normally and does not indicate faulty operation. Continue to depress the brake pedal.

### NOTE

- You may hear an operation noise when the brake pedal is suddenly or fully depressed while stationary. This does not indicate a malfunction and the brake assist system is operating normally.
- When the anti-lock brake system warning light or only active stability control warning light illuminate, the brake assist system is not functioning.

## Anti-lock braking system (ABS)

N00517901348

The anti-lock braking system (ABS) helps prevent the wheels from locking up when braking. This helps maintain vehicle drivability and steering wheel handling.

### Driving hints

- When using the ABS (sudden braking), steering is slightly different from normal driving conditions. Use the steering wheel carefully.
- Always keep a safe distance from the vehicle in front of you. Even if your vehicle is equipped with the ABS, leave a greater braking distance when:
  - Driving on gravel or snow-covered roads.

## Anti-lock braking system (ABS)

- Driving on uneven road surfaces.
- Operation of ABS is not restricted to situations where brakes are applied suddenly. This system may also prevent the wheels from locking when you drive over manholes, steel roadwork plates, road markings, or any uneven road surface.
- When the ABS is in use, you may feel the brake pedal vibrating and hear a unique sound. You may also feel as if the pedal resists being pressed.

**In this situation, simply hold the brake pedal down firmly. Do not pump the brake, which will result in reduced braking performance.**

### CAUTION

- The ABS cannot prevent accidents. It is your responsibility to take safety precautions and to drive carefully.
- To prevent failure of the ABS, be sure all 4 wheels and tires are the same size and the same type.
- Do not install any aftermarket limited slip differential (LSD) on your vehicle. The ABS may stop functioning properly.

### NOTE

- A whining sound is emitted from the engine compartment when driving immediately after starting the Plug-in Hybrid EV system. These are the normal sounds the ABS makes when performing a self-check. It does not indicate a malfunction.
- The ABS can be used after the vehicle has reached a speed over approximately 6 mph (10 km/h). It stops working when the vehicle slows below 3 mph (5 km/h).

## ABS warning light / display

N00531601714

Warning light



Warning display



If there is a malfunction in the system, the ABS warning light will come on and the warning display will appear on the information screen in the multi-information display. Under normal conditions, the ABS warning light only comes on when the operation mode

of the power switch is put in ON and goes off a few seconds later.

### CAUTION

- Any of the following indicates that the ABS is not functioning and only the standard brake system is working. (The standard brake system is functioning normally.) If this happens, take your vehicle to a certified Mitsubishi EV dealer.
  - When the operation mode of the power switch is put in ON, the warning light does not come on or it remains on and does not go off
  - The warning light comes on while driving
  - The warning display appears while driving

5

## If the warning light / display illuminate while driving

N00531701728

## If only the ABS warning light / display illuminate

- Avoid hard braking and high-speed driving. Stop the vehicle in a safe place. Test the system by restarting the Plug-in Hybrid EV system and driving at a speed of approximately 12 mph (20 km/h) or higher.

## Electric power steering system (EPS)

If the warning light / display then remains off during driving, there is no abnormal condition.

However, if the warning light / display do not disappear, or if they come on again when the vehicle is driven, have the vehicle checked by a certified Mitsubishi EV dealer as soon as possible.

**5**

### If the ABS warning light / display and brake warning light / display illuminate at the same time

Warning light



Warning display



5-80 Features and controls

The ABS and brake force distribution function may not work, so hard braking could make the vehicle unstable.

Avoid hard braking and high-speed driving. Stop the vehicle in a safe place and contact a certified Mitsubishi EV dealer.

#### NOTE

- The ABS warning light and brake warning light illuminate at the same time and the warning displays appear alternately on the information screen in the multi-information display.

## After driving on icy roads

N00529201120

After driving on snow or icy roads, remove any snow and ice which may have been left around the wheels. On vehicles that have an ABS, be careful not to damage the wheel speed sensors (A) or the cables located at each wheel.

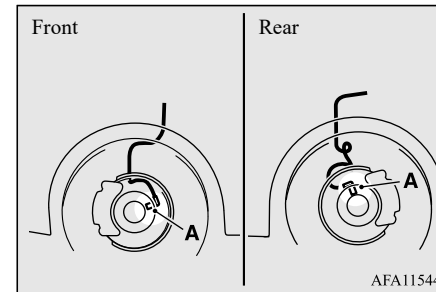

AFA115447

## Electric power steering system (EPS)

N00568401130

The power steering system operates while the Plug-in Hybrid EV System is operating. It helps reduce the effort needed to turn the steering wheel.

The power steering system has mechanical steering capability in case the power assist is lost. If the power assist is lost for some rea-



son, you will still be able to steer your vehicle, but you will notice it takes much more effort to steer. If this happens, have your vehicle inspected at a certified Mitsubishi EV dealer.

### WARNING

- Do not stop the Plug-in Hybrid EV System while the vehicle is moving. Stopping the Plug-in Hybrid EV System would make the steering wheel extremely hard to turn, possibly resulting in an accident.

### NOTE

- During repeated full-lock turning of the steering wheel (for example, while you are manoeuvring the vehicle into a parking space), a protection function may be activated to prevent overheating of the power steering system. This function will make the steering wheel gradually harder to turn. In this event, limit your turning of the steering wheel for a while. When the system has cooled down, the steering effort will return to normal.
- If you turn the steering wheel while the vehicle is stationary with the headlights on, the headlights may become dim. This behavior is not abnormal. The headlights will return to their original brightness after a short while.

## Electric power steering system warning display



If there is a malfunction in the system, the warning display will appear on the information screen in the multi-information display.

### CAUTION

- If the warning display appears while the Plug-in Hybrid EV System is operating, have the vehicle inspected by a certified Mitsubishi EV dealer as soon as possible. It may become harder to turn the steering wheel.

## Active stability control (ASC)

N00559101186

The Active stability control (ASC) takes overall control of the anti-lock braking system (ABS), traction control function and skid control function to help maintain the vehicle's control and traction. Please read this section in conjunction with the page on the ABS, traction control function and skid control function.

## Active stability control (ASC)

Anti-lock braking system (ABS) → P.5-78  
Traction control function → P.5-82  
Skid control function → P.5-82

### CAUTION

- Do not over-rely on the ASC. Even the ASC cannot prevent the natural laws of physics from acting on the vehicle. This system, like any other system, has limits and cannot help you to maintain traction and control of the vehicle in all circumstances. Reckless driving can lead to accidents. It is the driver's responsibility to drive carefully, This means taking into account the traffic, road and environmental conditions.
- Be sure to use the same specified type and size of tire on all four wheels. Otherwise, the ASC may not work properly.
- Do not install any aftermarket limited slip differential (LSD) on your vehicle. The ASC may stop functioning properly.

### NOTE

- An operation noise may be emitted from the engine compartment in the following situations. The sound is associated with checking the operations of the ASC. At this time, you may feel a shock from the brake pedal if you depress it. These do not indicate a malfunction.
  - When the operation mode of the power switch is put in ON.

## Active stability control (ASC)

5

### NOTE

- When the vehicle is driven for a while after starting the Plug-in Hybrid EV System.
- When the ASC is activated, you may feel a vibration in the vehicle body or hear a whining sound from the engine compartment. This indicates that the system is operating normally. It does not indicate a malfunction.
- When the ABS warning light is illuminated, the ASC is not active.

## Traction control function

N00559200021

On slippery surfaces, the traction control function prevents the drive wheels from spinning excessive, thus helping the vehicle to start moving from a stopped condition. It also provides sufficient driving force and steering performance as the vehicle turns while pressing the acceleration pedal.

### CAUTION

- When driving a vehicle on a snowy or icy road, be sure to install snow tires and drive the vehicle at moderate speeds.

## Skid control function

N00559301061

The skid control function is designed to help the driver maintain control of the vehicle on

slippery roads or during rapid steering maneuvers. It works by controlling the power drive unit output and the brake on each wheel.



### NOTE

- The skid control function operates at speeds of approximately 9 mph (15 km/h) or higher.

## ASC OFF switch

N00559401349

The ASC is automatically activated when the operation mode of the power switch is put in ON. You can deactivate the system by pressing down the ASC OFF switch for 3 seconds or longer.

When the ASC is deactivated, the  indicator will turn on. To reactivate the ASC, momentarily press the ASC OFF switch; the  indicator is turned off.

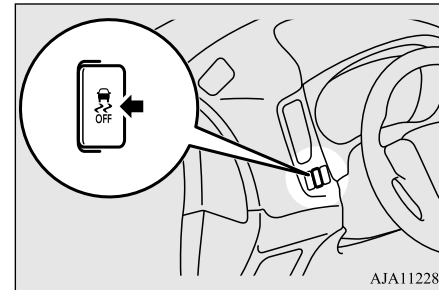

AJA112288

### CAUTION

- For safety reasons, the ASC OFF switch should be operated when your vehicle is stopped.
- Be sure to keep the ASC on while driving in normal circumstances.

## Active stability control (ASC)

### CAUTION



- Never deactivate the ASC unless necessary to move out of mud, sand or fresh snow. Reactivate the ASC immediately when done.
- If you depress the accelerator pedal excessively while the ASC is deactivated, the vehicle may suddenly lurch forward/backward causing injury to nearby people, damage to nearby objects, or the wheels may spin excessively causing damage to the vehicle.

### NOTE

- Using the ASC OFF switch turns off both the stability control function and the traction control function.
- When moving out of mud, sand or fresh snow, pressing the accelerator pedal may not allow the power drive unit output to increase. In such situations, switching to “LOCK” with the drive mode switch and temporarily turning off ASC with the ASC OFF switch will make it easier to move out your vehicle. Refer to “Operation under adverse driving conditions: If your vehicle becomes stuck in sand, mud or snow” page 8-19.
- If you continue to press the ASC OFF switch after the ASC is turned off, the “mistaken operation protection function” will activate and the ASC will turn back on.

### ASC operation display or ASC OFF indicator



N00559501236

-  - ASC operation display/ASC indicator  
The display/indicator will blink when the ASC is operating.
-  - ASC OFF indicator  
This indicator will turn on when the ASC is turned off with the ASC OFF switch.

### CAUTION

- When  display/indicator blinks, ASC is operating, which means that the road is slippery or that your vehicle’s wheels are beginning to slip. If this happens, drive slower.

### CAUTION

- If the temperature in the braking system continues to increase due to continuous brake control on a slippery road surface, the  indicator will blink.  
To prevent the brake system from overheating, the brake control of the traction control function will be temporarily suspended. The power drive unit output control of the traction control function and normal brake operation will not be affected. Park your vehicle in a safe place. When the temperature in the braking system has come down, the  indicator will be turned off and the traction control function will start operating again.

5

### NOTE

- The  indicator may come on when you start the Plug-in Hybrid EV System. This means that the 12 V starter battery voltage momentarily dropped when the Plug-in Hybrid EV System was started. It does not indicate a malfunction, provided that the display goes out immediately.



## Cruise control (if so equipped)

### ASC warning display

N00546601132

If an abnormal condition occurs in the system, the following display/indicator will turn on.

5

-  - ASC indicator
-  - ASC OFF indicator

### Warning display



### CAUTION

- The system may be malfunctioning. Park your vehicle in a safe place and stop the Plug-in Hybrid EV System. Restart the Plug-in Hybrid EV System and check whether the display/indicator goes out. If they go out, there is no abnormal condition. If they do not go out or if they turn on frequently, it is not necessary to stop the vehicle immediately, but you should have your vehicle inspected by a certified Mitsubishi EV dealer as soon as possible.

### Cruise control (if so equipped)

N00518301697

Cruise control is an automatic speed control system that keeps a set speed. It can be activated at speeds from approximately 25 mph (40 km/h). Cruise control does not work at speeds below approximately 25 mph (40 km/h).

### CAUTION

- When you do not wish to drive at a set speed, turn off the cruise control for safety.
- Do not use cruise control when driving conditions will not allow you to stay at the same speed, such as in heavy traffic or on roads that are winding, icy, snow-covered, wet, slippery, on a steep downhill slope.

### NOTE

- Cruise control may not be able to keep your speed on uphill or downhill.
- Your speed may decrease on a steep uphill. You may use the accelerator pedal if you want to stay at your set speed.
- Your speed may increase to more than the set speed on a steep downhill. You have to use the brake to control your speed. As a result, the set speed driving is deactivated.

### NOTE

- The regenerative braking level B0 or B1 cannot be selected under the cruise control. The buzzer sounds if you try to select these levels.

### Cruise control switches

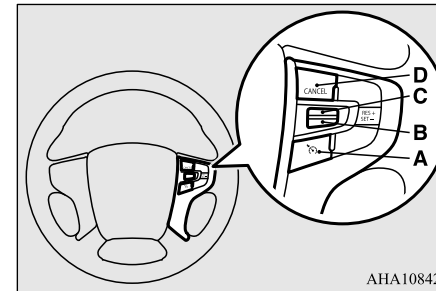

AHA108425

#### A- CRUISE CONTROL ON/OFF switch

Used to turn on and off the cruise control.

#### B- "SET -" switch

Used to reduce the set speed and to set the desired speed.

#### C- "RES +" switch

Used to increase the set speed and to return to the original set speed.

#### D- "CANCEL" switch

Used to deactivate the set speed driving.

## Cruise control (if so equipped)

### NOTE

- When operating the cruise control switches, press the cruise control switches correctly. The set speed driving may be deactivated automatically if two or more switches of the cruise control are pressed at the same time.

### To activate

N00518401483

1. With the operation mode of the power switch in ON, press the CRUISE CONTROL ON/OFF switch (A) to turn on the cruise control.

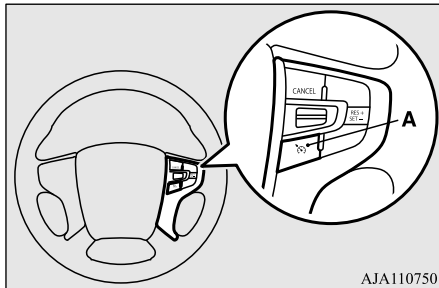

The cruise indicator display appears on the information screen in the multi-information display.

### Indicator display



2. Accelerate or decelerate to your desired speed, then push down and release the “SET -” switch (B). The “SET” indicator appears on the information display in the multi-information screen. The vehicle will then maintain the desired speed.

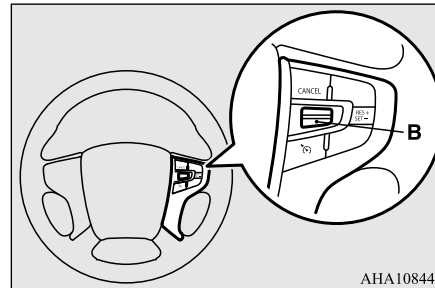

### NOTE

- When you release the “SET -” switch (B), the vehicle speed will be set.

### To increase the set speed

N00518501426

There are two ways to increase the set speed.

#### “RES +” switch

Push up and hold the “RES +” switch (C) while driving at the set speed, and your speed will then gradually increase. When you reach your desired speed, release the switch. Your new cruising speed is now set.

**5**

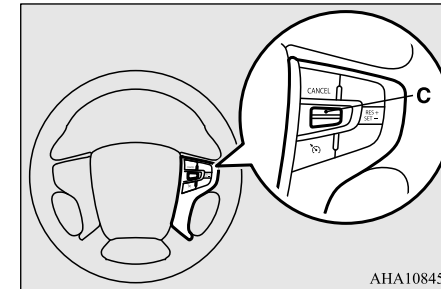

To increase your speed in small amounts, push up the “RES +” switch (C) for less than approximately 1 second and release it. Each time you press the “RES +” switch (C), your vehicle will go approximately 1 mph (1.6 km/h) faster.

## Cruise control (if so equipped)

### Accelerator pedal

While driving at the set speed, use the accelerator pedal to reach your desired speed and then push down the “SET -” switch (B) and release the switch momentarily to set a new desired cruising speed.

5

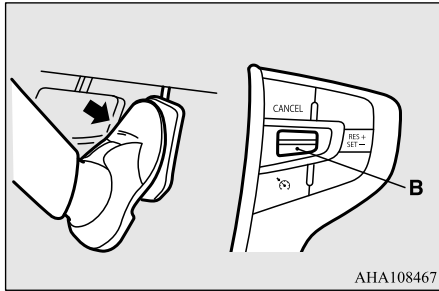

### “SET -” switch

Push down and hold the “SET -” switch (B) while driving at the set speed, and your speed will slow down gradually. When you reach your desired speed, release the switch. Your new cruising speed is now set.

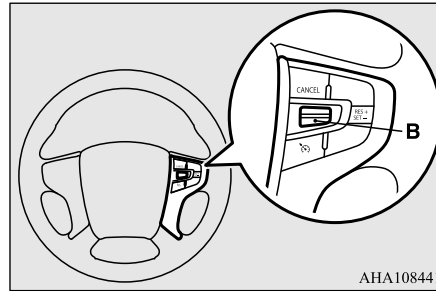

### Brake pedal

While driving at the set speed, use the brake pedal, which disengages the cruise control, then push down the “SET -” switch (B) and release the switch momentarily to set a new desired cruising speed.

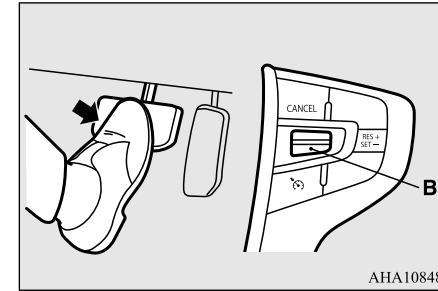

### To decrease the set speed

N00518601355

There are two ways to decrease the set speed.

To slow down your speed in small amounts, push down the “SET -” switch (B) for less than approximately 1 second and release it. Each time you push down the “SET -” switch (B), your vehicle will slow down by approximately 1 mph (1.6 km/h).

### To temporarily increase or decrease the speed

N00541701125

### To temporarily increase the speed

Depress the accelerator pedal as you would normally. When you release the pedal, you will return to your set speed.

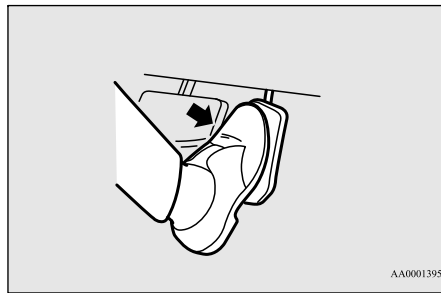

#### NOTE

- In some driving conditions, the set speed driving may be deactivated. If this happens, refer to “To activate” on page 5-85 and repeat the speed setting procedure.

### To temporarily decrease the speed

Depress the brake pedal to decrease the speed. To return to the previously set speed, push up the “RES +” switch (C). Refer to “To resume the set speed” on page 5-88.

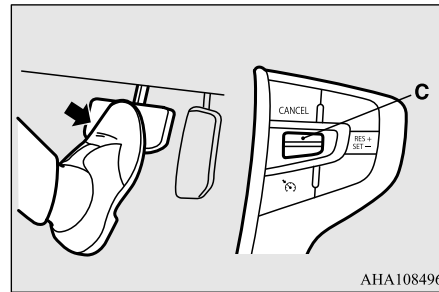

### To deactivate

N00518801621

The set speed driving can be deactivated as follows:

- Press the CRUISE CONTROL ON/OFF switch (A) (Cruise control will be turned off.)
- Press the CANCEL switch (D).

### Cruise control (if so equipped)

- Depress the brake pedal.

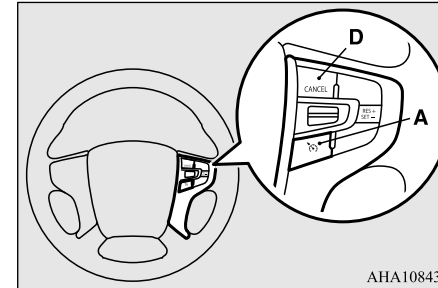

5

The set speed driving is deactivated automatically in any of the following ways.

- When your speed slows to approximately 10 mph (15 km/h) or more below the set speed because of a hill, etc.
- When your speed slows to approximately 25 mph (40 km/h) or less.
- When the active stability control (ASC) starts operating. Refer to “Active stability control (ASC)” on page 5-81.

## Adaptive Cruise Control System (ACC) (if so equipped)

### ⚠ WARNING

- Although the set speed driving will be deactivated when shifting to the “N” (NEUTRAL) position, never move the selector lever to the “N” (NEUTRAL) position while driving. You would have no regenerative braking and could cause a serious accident.

5

### ⚠ CAUTION

- When the set speed driving is deactivated automatically in any situation other than those listed above, there may be a system malfunction. Press the CRUISE CONTROL ON/OFF switch to turn off the cruise control and have your vehicle inspected by a certified Mitsubishi EV dealer.

### To resume the set speed

N00518901417

If the set speed driving is deactivated by the condition described in “To deactivate” on page 5-87, you can resume the previously set speed by push up the “RES +” switch (C) while driving at a speed of approximately 25 mph (40 km/h) or higher. The “SET” indicator appears on the information screen in the meter cluster.

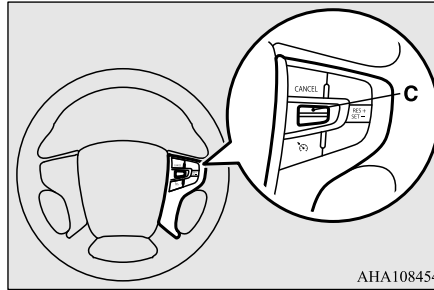

AHA108454

Under either of the following conditions, however, using the switch does not allow you to resume the previously set speed. In these situations, repeat the speed setting procedure:

- The CRUISE CONTROL ON/OFF switch is pressed.
- The operation mode of the power switch is put in OFF.
- The cruise indicator goes off.

### Adaptive Cruise Control System (ACC) (if so equipped)

N00576800077

Adaptive Cruise Control System (ACC) maintains a set speed with no need for you to use the accelerator pedal. Using a sensor (A), the system also measures the relative speed and distance between your vehicle and a vehicle in front, and maintains a set following dis-

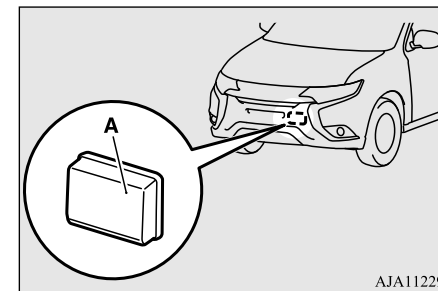

AJA112291

tance between your vehicle and the vehicle in front by automatically decelerating your vehicle if it becomes too close to the vehicle in front.

The cruising set speed can be set from 25 mph (40 km/h) to 110 mph (180 km/h). The distance can be selected from three levels.

If the vehicle in front decelerates, the ACC will automatically apply limited braking to maintain the distance, and if the front vehicle then accelerates, the ACC will automatically accelerate your vehicle up to the set speed. If your vehicle is approaching too close to the front vehicle, a buzzer will sound and a warning is shown in the multi-information display. When the ACC detects no vehicle ahead, the set speed will be maintained.

Conventional cruise control mode without the distance control can also be selected.

Stop lights are illuminated during automatic braking.



## Adaptive Cruise Control System (ACC) (if so equipped)

### **WARNING**

- Before using the ACC, read this entire section to understand the limitations of this system. Failure to follow instructions could result in an accident.
- Never rely solely on the ACC. The ACC is not a collision avoidance system or an automatic driving system. It is designed to use only limited braking and is never a substitute for your safe and careful driving. Always be ready to apply the brakes manually.

### **NOTE**

- While the ACC is operating, the regenerative braking level cannot be changed. If you attempt to change the level, a buzzer will sound.
- If the ACC is turned on while the “B” (REGENERATIVE BRAKE) position is selected, the shift position will be automatically changed to the “D” (DRIVE) position.

### Cruise control switch

N0057700034

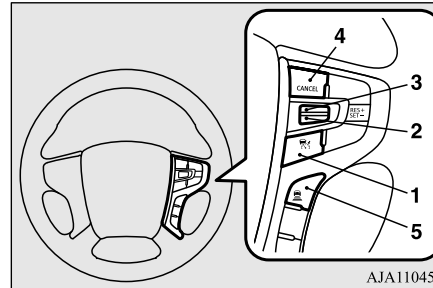

AJA110457

- “ACC ON/OFF” switch**  
Used to turn on and off the ACC system.
- “SET -” switch**  
Used to set a desired speed or to reduce the set speed.
- “RES +” switch**  
Used to resume the control function after cancelling the ACC or the conventional cruise control. Also used to increase the set speed.
- “CANCEL” switch**  
Used to cancel the control function of the ACC or the cruise control.
- ACC distance switch**  
Used to set or change the following distance between your vehicle and a vehicle in front.

### **NOTE**

- When operating the cruise control switches, press the cruise control switches correctly. The ACC may be deactivated automatically if two or more switches of the cruise control are pressed at the same time.

### ACC Indicators

N00577100051

While the ACC is turned on, indicators for the ACC are shown in the multi-information display.

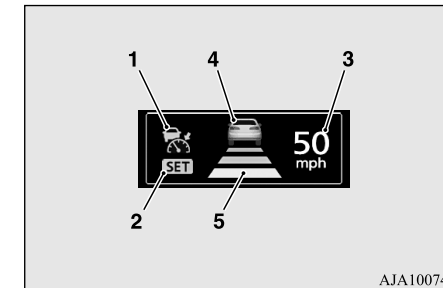

AJA100744

- ACC indicator:**  
Indicating that the ACC is turned on.
- Control state indicator:**  
Indicating that ACC is activated.

## Adaptive Cruise Control System (ACC) (if so equipped)

5

### 3- Set speed indicator:

Indicating the set speed.



If the set speed is not set, “---” is shown.

### 4- Front vehicle indicator:

Indicating when the ACC detects a vehicle ahead.

When a front vehicle is detected while the ACC is activated, the ‘Active’ front vehicle indicator shown in the illustration below will illuminate.

When a front vehicle is detected while the ACC is not activated or the ACC is canceled, the ‘Stand by’ front vehicle indicator will illuminate.

Display	State	
	Stand by	Active
Vehicle in front detected		







### 5-Following distance indicator:

Indicating the following distance.

Two states: “Stand by” and “Active”

When a front vehicle is detected while the ACC is activated, the ‘Active’ following distance indicator shown in the illustration below will illuminate.

When a front vehicle is detected while the ACC is not activated or the ACC is canceled, the ‘Stand by’ following distance indicator will illuminate.

Following distance setting symbol	State	
	Stand by	Active
Long		
Middle		
Short		

## How to use ACC

N00577200078

### To turn on ACC

When the operation mode of the power switch is in ON, press the “ACC ON/OFF” switch.

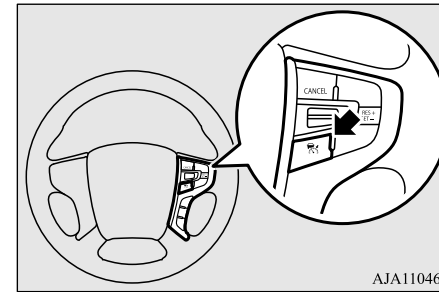

The ACC indicators will appear in the multi-information display.

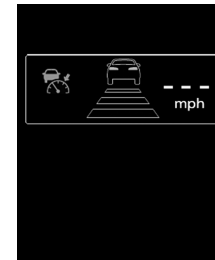

## Adaptive Cruise Control System (ACC) (if so equipped)

### NOTE

- Every time the operation mode is put in OFF, the ACC is turned off.

### To turn off ACC

Press the “ACC ON/OFF” switch to turn off the ACC.

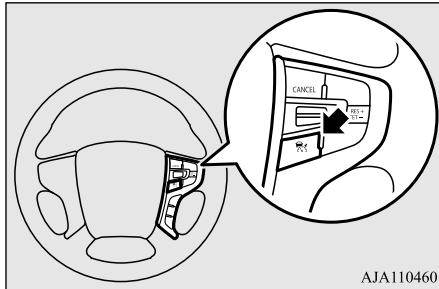

### NOTE

- The ACC can be turned off even while the ACC is active.
- Every time the operation mode is put in OFF, the ACC is turned off and the set speed is erased.

### To activate ACC control

With the ACC turned on, push down the “SET -” switch while driving, and when your vehicle reaches your desired speed, release the “SET -” switch. The ACC will activate and initiate the speed control to maintain the set speed.

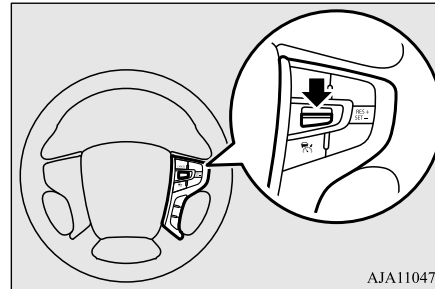

The set indicator comes on, the set speed is indicated and the following distance indicator changes to the ‘active’ display. Also a buzzer will sound.



You can set the speed anywhere from approximately 25 mph (40 km/h) to 110 mph (180 km/h).

While a vehicle in front is being detected and your vehicle speed is between approximately 6 mph (10 km/h) and 25 mph (40 km/h), you can activate the ACC. In this case, the set speed will be set at 25 mph (40 km/h).

The ACC cannot otherwise be activated while your vehicle is traveling less than 25 mph (40 km/h) or greater than 110 mph (180 km/h).

5

### NOTE

- When any of the following conditions are present, the ACC will not activate.
  - When your vehicle speed is lower than approximately 6 mph (10 km/h) or greater than 110 mph (180 km/h).
  - When your vehicle is driven at speeds between approximately 6 mph (10 km/h) and 25 mph (40 km/h) and the ACC is not detecting a vehicle in front.
  - When ASC is in the OFF position.
  - While ABS, ASC or TCL is activated.
  - When the select position is in the “P” (PARK), the “R” (REVERSE) or the “N” (NEUTRAL) position.
  - While the brake pedal is depressed.
  - While the parking brake is applied.
  - When the ACC system has judged that the performance for detecting a front vehicle is degraded.

## Adaptive Cruise Control System (ACC) (if so equipped)

### NOTE

- When an abnormality in the ACC system has been detected.

### When ACC detects no vehicle in front within the set distance

5

The speed of your vehicle will be maintained at the speed you have set. The speed can be set between approximately 25 mph (40 km/h) and 110 mph (180 km/h).

### NOTE

- If the vehicle speed exceeds the set speed on a down slope, the system will automatically apply the brake to maintain the vehicle set speed.

### When ACC detects a vehicle in front within the set distance

N00581400055

The ACC will maintain the distance to the front vehicle and will apply the brakes automatically when the system judges braking is necessary. The distance can be selected from three levels.

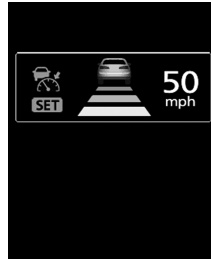

When the front vehicle stops, the ACC will automatically apply the brakes to stop your vehicle.

A few seconds after your vehicle has stopped, the ACC will release the brakes and your vehicle will start to move or creep slowly. You must apply the brakes to keep your vehicle stationary.



### WARNING

- Never leave the vehicle while it is being stopped by the ACC.

### NOTE

- If the brake pedal is not depressed within 2 seconds after your vehicle has been stopped by the ACC, a warning buzzer will sound, the above warning will be shown in the multi-information display to alert the driver, and the ACC control will be canceled.

## Adaptive Cruise Control System (ACC) (if so equipped)

### NOTE

- When depressing the brake pedal while the automatic brake is applied, the brake pedal will feel firm. This is normal. Depress the brake pedal harder to apply greater braking force.
- During the automatic braking, operation sounds may be heard. This is normal.

When the ACC no longer detects a vehicle in front, the buzzer will sound, the vehicle symbol in the display will disappear and your vehicle will slowly accelerate to the set speed.



### WARNING

- Your vehicle may accelerate up to the set speed in the following situations. Apply the brake, if necessary, to slow down.

### WARNING

- When your vehicle no longer follows the vehicle in front, e.g. at a freeway exit or when your vehicle or the vehicle in front changes its lane.

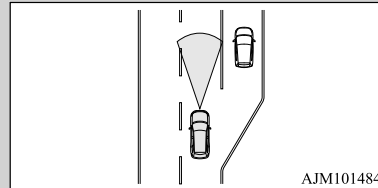

- When driving on a curve.

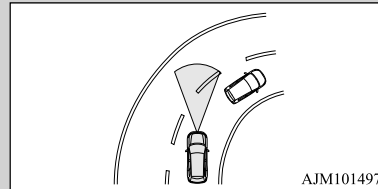

- When the vehicle in front has changed its course or lane, if a stationary vehicle appears in front your vehicle, the ACC will not decelerate your vehicle.

### Approach alarm

N00576900049

While the ACC is activated, if your vehicle is approaching too closely to the vehicle in front, the ACC gives a warning by sounding a buzzer and displaying a message. Apply the

brakes to maintain the appropriate distance to the vehicle in front.

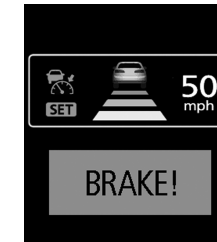

5

### WARNING

- When the ACC is not being used, turn off the system to avoid unexpected ACC activation.
- Never operate the ACC from outside the vehicle.
- The ACC will not decelerate your vehicle and/or give the approach alarm in the following cases.
  - When an object other than a vehicle, such as a pedestrian, is in front.
  - When a malfunction is detected in the system.
- The ACC will not decelerate your vehicle in the following cases, but will give the approach alarm.
  - When the front vehicle is stationary or moving at an extremely slow speed.
  - When your brake system has a problem, such as overheating.

## Adaptive Cruise Control System (ACC) (if so equipped)

5

### ⚠ WARNING

- The ACC may not be able to maintain the set speed or the distance to a vehicle in front and may not alert the driver, if the system cannot detect the front vehicle properly. Typical situations include:
  - When a vehicle cuts into your path at a close distance.
  - When a vehicle in front is not completely in your path.
  - When a vehicle in front is towing a trailer.
  - When a motorcycle or a bicycle is in front.
  - When a vehicle in front is a truck loaded with freight that protrudes rearward from the cargo bed.
  - When the height of a vehicle in front is extremely low or the road clearance of the vehicle is extremely high.
  - When driving on a road with alternating up and down surfaces.
  - When driving on a curve.
  - When driving on a bumpy or rough road.
  - When driving in a tunnel.
  - When driving in construction zones.
  - When the rear of your vehicle is weighed down with the weight of passengers and luggage.
  - For up to two minutes after starting driving.

### ⚠ WARNING

- When driving in curved sections of road including their entrance/outlet or running beside a closed lane in a traffic work or similar zone.

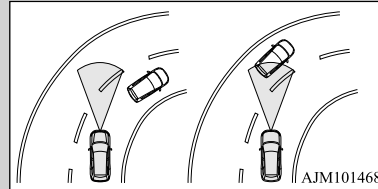

- When the surface of the sensor is covered with dirt, snow, ice, etc.
- When a front vehicle or an oncoming vehicle is splashing water, snow or dirt.
- When driving on a winding road.

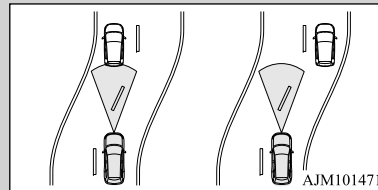

- Never use the ACC in the following situations:
  - In heavy traffic.
  - On winding roads.
  - On slippery roads, such as icy, snow-covered or dirt roads.
  - In adverse weather conditions, such as rain, snow or sand storms, etc.
  - On steep downslopes.

### ⚠ WARNING

- When the inclination of a road frequently changes.
- When the approach alarm frequently sounds.
- When your vehicle is towed or is towing another vehicle.
- When your vehicle is on a chassis dynamometer or free rollers.
- When tire inflation pressures are not adequate.
- When the radar sensor and/or its surrounding area are damaged or deformed.

### ⚠ CAUTION

- To maintain proper performance of the ACC:
  - Always clean the surface of the radar sensor.
  - Avoid impacting the radar sensor or its surrounding area.
  - Do not put a sticker on the radar sensor or its surrounding area.
  - Do not paint the radar sensor.
  - Do not install a grill guard.
  - Do not modify the radar sensor or its surrounding area.
  - Always use tires of the same size, same type, and same brand, and which have no significant wear differences.
  - Do not modify the vehicle's suspension.

## Adaptive Cruise Control System (ACC) (if so equipped)

### To increase the set speed

N00581500056

There are two ways to increase the set speed.

#### By using the “RES +” switch:

The set speed will increase by 1 mph (1 km/h) every time you push up the “RES +” switch while the ACC is activated. If you hold the switch pushed up, the set speed increases in 5 mph (5 km/h) increments.

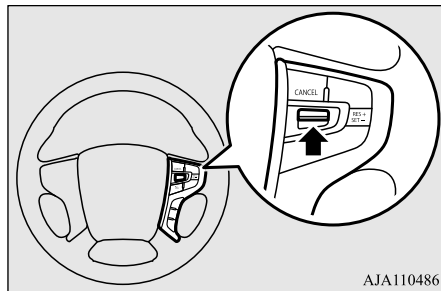

#### NOTE

- There is some time lag until the vehicle begins accelerating to the new set speed after the set speed has been changed.

#### NOTE

- The set speed can be changed even while your vehicle is following a vehicle in front using the ACC. In this case, however, although the set speed itself is increased, your vehicle will not accelerate.
- When the switch is held, a buzzer will sound every time the set speed changes

#### By using the accelerator pedal:

When the accelerator pedal is depressed while driving with the ACC control working, you can accelerate the vehicle beyond the presently set speed.

When the vehicle speed reaches your desired speed, push down and release the “SET -” switch and release the accelerator pedal; the new speed is then set in the system.

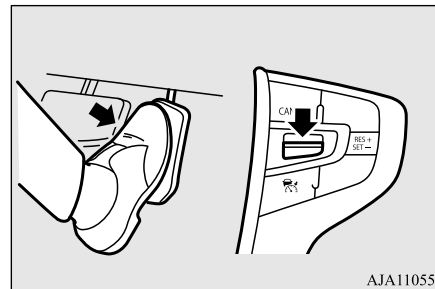

#### WARNING

- The ACC braking control and approach alarm functions will not work while the accelerator pedal is depressed.

#### NOTE

- The set speed indicator in the multi-information display will show “-” while the accelerator pedal is depressed.
- If the “SET -” button is not pushed down while depressing the accelerator pedal, your vehicle speed will return to the set speed, after the accelerator pedal is released. When the accelerator pedal is released, the ACC braking control and approach alarm functions may not immediately work.

5

### To decrease the set speed

N00581600031

There are two ways to decrease the set speed.

## Adaptive Cruise Control System (ACC) (if so equipped)

### By using the “SET -” switch:

The set speed will decrease by 1 mph (1 km/h) every time you push down the “SET -” switch while the ACC is activated. If you hold the switch pushed down, the set speed decreases in 5 mph (5 km/h) increments.

5

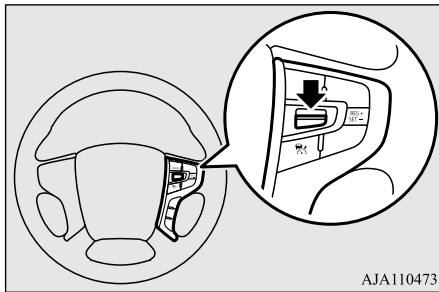

#### NOTE

- There is some time lag until the vehicle begins decelerating after the set speed has been changed.
- The set speed can be changed even while your vehicle is following a vehicle in front using the ACC. In this case, however, although the set speed itself is decreased, your vehicle will not decelerate.
- When the switch is held, a buzzer will sound every time the set speed changes

### By using the brake pedal:

By depressing the brake pedal while the ACC is activated, the ACC control is canceled and your vehicle speed will decrease.

At the point where the vehicle speed reaches your desired speed, push down and release the “SET -” switch; the new speed is then set in the system.

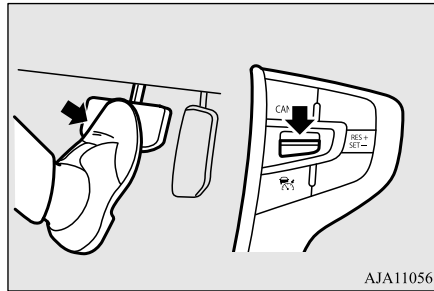

#### NOTE

- The ACC control will not resume after releasing the brake pedal.

### To temporarily accelerate the vehicle

N00582800027

Simply depress the accelerator pedal to temporarily accelerate the vehicle. Releasing the

pedal automatically slows down the vehicle to the set speed and ACC restarts its control.

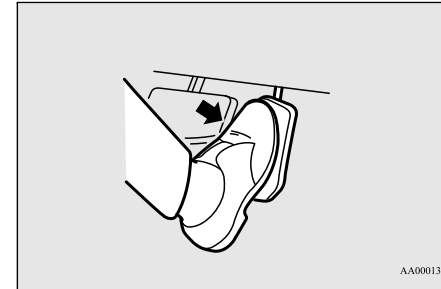

#### WARNING

- The ACC braking control and approach alarm functions will not work while the accelerator pedal is depressed.

#### NOTE

- The set speed indication on the display turns to “---” when the accelerator pedal is depressed. This indication remains as long as the pedal is in a depressed position.
- In certain conditions, the braking control and alarming functions of ACC may not work for a short while after releasing the accelerator pedal.



## Adaptive Cruise Control System (ACC) (if so equipped)

### To cancel ACC control

N00581700087

There are two ways to cancel the ACC control.

- By pressing the “CANCEL” switch.
- By depressing the brake pedal.

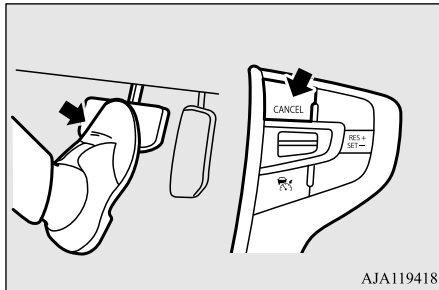

### NOTE

- You can also cancel the ACC control by pressing the “ACC ON/OFF” switch. If this switch is pressed while the ACC is “ON”, the ACC will be turned off.

When the ACC is canceled, the “SET” indicator goes off and the following distance indicator turns to the ‘standby’ display. The front vehicle indicator also turns to the ‘standby’ display when a front vehicle is detected.

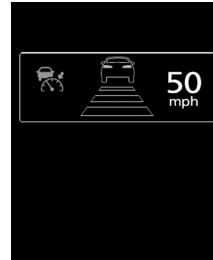

In any of the situations listed below, the ACC control is automatically canceled, a buzzer sounds and a message is shown in the multi-information display.



- When your vehicle stops.
- When the ASC is turned off.
- While ABS, ASC or TCL is activated.

- When the select position is in the “P” (PARK), the “R” (REVERSE) or the “N” (NEUTRAL) position.
- When the parking brake is applied.

When the ACC system determines that its performance has been degraded, a buzzer will sound and a message will be displayed in the multi-information display.

5

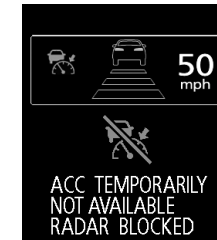

This can occur when

- Foreign objects, such as dirt, snow or ice, adhere to the surface of the radar sensor.
- In adverse weather conditions, such as rain, snow or sand storms, etc.
- A front vehicle or an oncoming vehicle is splashing water, snow or dirt.
- Driving on a nonbusy road with a few vehicles and obstacles in front.
- The brake system is overheating due to continuous brake control on long down-hill slope.

## Adaptive Cruise Control System (ACC) (if so equipped)

If the display keeps showing the message, there is a possibility that the ACC has a malfunction. Contact a certified Mitsubishi EV dealer.

### To resume the control

N00581800046

- 5** After the ACC control has been canceled with the ACC turned on, the ACC control can be resumed by pushing up and releasing the “RES +” switch.

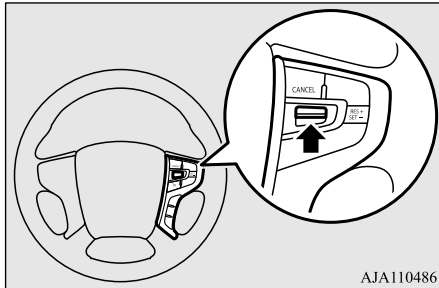

### NOTE

- When any of the following conditions are present, the ACC control cannot be resumed.
  - When your vehicle speed is lower than approximately 6 mph (10 km/h) or higher than 110 mph (180 km/h).

### NOTE

- When your vehicle is driven at speeds between approximately 6 mph (10 km/h) and 25 mph (40 km/h) and the ACC is not detecting a vehicle in front.
- When ASC is in the OFF position.
- While ABS, ASC or TCL is activated.
- When the select position is in the “P” (PARK), the “R” (REVERSE) or the “N” (NEUTRAL) position.
- While the brake pedal is depressed.
- While the parking brake is applied.
- When the ACC system has judged that the performance for detecting a front vehicle is degraded.
- When an abnormality in the ACC system has been detected.

### To change the following distance

N00581900034

With the ACC turned on, the distance between your vehicle and a vehicle ahead can be selected from three levels by pushing the ACC distance switch. Each time the ACC distance switch is pushed, the following distance will change from “Long” to “Middle”, to “Short”, and return to “Long” again. Every time the ACC is turned to ON, the following distance is reset to “Long”.

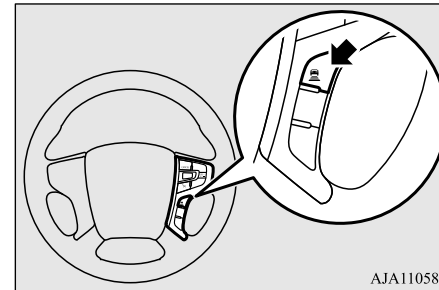

### NOTE

- Actual distance will vary depending on your vehicle speed and the front vehicle speed. The distance will become longer when the vehicle speeds are higher.

## Adaptive Cruise Control System (ACC) (if so equipped)

The following distance indicator shows the level of the following distance:

“Long”



“Middle”



“Short”



### To activate conventional cruise control

N00582000058

Press and hold the “ACC ON/OFF” switch while the operation mode of the power switch is put in ON. A buzzer will sound and the multi-information display will show the following indicator.



The conventional cruise control is turned off when the operation mode is put in OFF.

For operation of the cruise control, refer to “Cruise control” on page 5-84.

### NOTE

- The conventional cruise control does not sound or display the approach alarm, will not adjust your vehicle speed, and does not control the distance between your vehicle and a vehicle in front.

### Warning display

N00590700038

When the ACC system detects an abnormality in the system, the ACC system will be turned off, a buzzer will sound and a message will be displayed in the multi-information display. If the message remains after the operation mode of the power switch is put in OFF and then turned back to ON, contact a certified Mitsubishi EV dealer.



### General information

N00582100091

#### For vehicles sold in U.S.A.

FCC ID:OAYARS3-B

This device complies with Part 15 of FCC Rules. Operation is subject to the following two conditions.

- (1) This device may not cause harmful interference, and
- (2) this device must accept any interference received, including interference that may cause undesired operation.

### CAUTION

- Changes or modifications not expressly approved by the party responsible for compliance could void the user’s authority to operate the equipment.

#### For vehicles sold in Canada

IC: 4135A-ARS3B

This device complies with Industry Canada licence-exempt RSS standard(s). Operation is subject to the following two conditions: (1) this device may not cause interference, and (2) this device must accept any interference, including interference that may cause undesired operation of the device.

## Forward Collision Mitigation System (FCM) (if so equipped)

### Para los vehículos vendidos en México

Certificado de homologación:

RVLCOAR10-0980-A1

Continental ARS3-B

Este equipo opera a título secundario, consecuentemente, debe aceptar interferencias perjudiciales incluyendo equipos de la misma clase y puede no causar interferencias a sistemas operando a título primario.

5

Cofetel notice:

“La operación de este equipo está sujeta a las siguientes dos condiciones:

- (1) es posible que este equipo o dispositivo no cause interferencia perjudicial y
- (2) este equipo o dispositivo debe aceptar cualquier interferencia, incluyendo la que pueda causar su operación no deseada.”

## Forward Collision Mitigation System (FCM) (if so equipped)

N00577300109

The Forward Collision Mitigation System (FCM) is designed to help reduce the risk of a collision with a vehicle or a pedestrian straight ahead of your vehicle. The FCM uses a sensor (A) to determine the distance and relative speed to a vehicle and a pedestrian in

front. The FCM is not designed as an automatic driving system or as a collision avoidance system.

When your vehicle is approaching a vehicle or a pedestrian straight ahead in your path and the FCM judges that there is the risk of a collision, the system will give audible and visual warnings.

When the FCM judges that a collision with the vehicle or the pedestrian straight-ahead is imminent, the system will automatically apply moderate braking to warn you to apply the brakes immediately.

When the FCM judges that a collision with the vehicle or the pedestrian straight-ahead is highly unavoidable, the system will apply emergency braking to reduce the severity of the collision and, if possible, to avoid the collision.

Stop lights are illuminated during automatic braking.

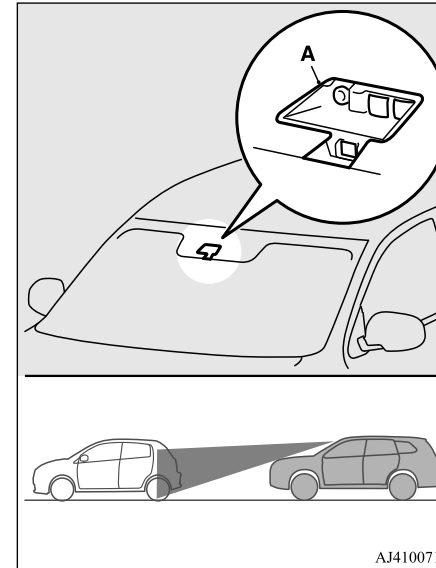

### ⚠ WARNING

- Before using the FCM, read this entire section to fully understand the limitations of this system. Failure to follow instructions could result in an accident.

## Forward Collision Mitigation System (FCM) (if so equipped)

### **⚠ WARNING**

- The FCM is designed to help avoid certain frontal collisions or reduce the crash speed in such collisions. It is not a substitute for your safe and careful driving. Under certain circumstances, the system may not operate or may not detect correctly a vehicle or a pedestrian in front. When your vehicle is approaching a vehicle or a pedestrian too closely, take all necessary actions to avoid a collision, such as braking and steering, regardless of whether the FCM is activated or not. Never rely on the FCM to prevent a collision.
- Never attempt to test the operation of the FCM. Doing so could cause an accident, resulting in serious injury or death.

### Forward collision warning function

N00577400038

If the system judges that there is a risk of your vehicle colliding with a vehicle or a pedestrian in front, this function warns you of the potential hazard with visual and audible alarms.

When this function is triggered, a buzzer sounds and, at the same time, a “BRAKE” message appears on the information screen of the multi-information display.

The FCM will also prepare to provide quick brake response and greater brake force when you apply the brakes.

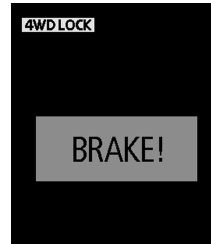

The forward collision warning function operates when the following vehicle speed:

- Against a vehicle: Approximately 10 mph (15 km/h) to 87 mph (140 km/h).
- Against a pedestrian: Approximately 5 mph (7 km/h) to 40 mph (65 km/h).

### FCM braking function

N00577700187

When the FCM judges that a collision with the vehicle or the pedestrian straight-ahead is imminent, the FCM will automatically apply moderate braking to warn the driver to apply the brakes immediately.

If the FCM judges that the collision is highly unavoidable, it will automatically apply emergency braking to reduce the severity of the collision and, if possible, to avoid the collision.

When the FCM applies emergency braking, a buzzer sounds and a warning message is displayed in the information screen of the multi-information display.



The FCM braking function operates when the following vehicle speed:

- Against a vehicle: Approximately 3 mph (5 km/h) to 50 mph (80 km/h)
- Against a pedestrian: Approximately 3 mph (5 km/h) to 40 mph (65 km/h)

## Forward Collision Mitigation System (FCM) (if so equipped)

5

**WARNING**

- If the ASC is turned off, the FCM braking function will not operate. Refer to “Active stability control (ASC)” on page 5-81.
- If the brake pedal is not depressed within 2 seconds after your vehicle has been stopped by the FCM, a warning buzzer will sound and the brakes activated by the FCM will automatically be released. Apply the brakes as necessary to keep your vehicle stationary.
- The FCM will not activate and will not provide either warning or braking in certain situations. Some of these include:
  - When the select position is in the “P” (PARK) or “R” (REVERSE) position.
  - When an object other than a vehicle or a pedestrian is in front.
  - When the FCM has detected a problem in the system.
  - When a vehicle or a pedestrian suddenly cuts in front of your vehicle.
  - When the vehicle in front is moving at a speed much lower than your vehicle’s speed.
- The FCM may or may not detect a motorcycle, bicycle or wall depending on the situation. The FCM is not designed to detect these objects.
- The forward collision warning function and/or the FCM braking function may not activate in certain situations. Some of these include:

**WARNING**

- When a vehicle suddenly appears just in front of your vehicle.
- When a vehicle cuts into your path at a close distance.
- When a vehicle ahead is not completely in your path.
- When your vehicle changed lanes, and your vehicle approached immediately behind the vehicle ahead.
- When a vehicle ahead is towing a trailer.
- When a vehicle ahead is a truck loaded with freight that protrudes rearward from the cargo bed.
- When the height of a vehicle ahead is extremely low or its road clearance is extremely high.
- When a vehicle ahead is extremely dirty.
- When a vehicle ahead is covered with snow.
- When a vehicle ahead has a large glass surface.
- When a vehicle ahead does not have reflectors (light reflector) or the position of the reflector is low.
- When a vehicle ahead is a car carrier or a similar shaped vehicle.
- When accelerating and decelerating quickly.
- When driving on a slippery road covered by rain water, snow, ice, etc.
- When driving on a road with alternating up and down steep slopes.

**WARNING**

- When driving on a curve.
- When driving on a bumpy or rough road.
- When driving in dark areas, such as in a tunnel or at night.
- When the system recognizes driver’s steering, accelerating, braking or gear shifting actions as evasive actions to avoid collision.
- When the rear of your vehicle is weighed down with the weight of passengers and luggage.
- Up to several seconds after starting driving.
- In adverse weather conditions, such as rain, snow, fog or sand-storm.
- When the windshield of the sensor portion is covered with dirt, water droplets, snow and ice, etc.
- When a vehicle ahead or an oncoming vehicle is splashing water, snow or dirt.
- When using a windshield washer.
- If windshield wipers are not Mitsubishi Motors Genuine parts or equivalent.
- When the sensor becomes extremely hot or cold.
- If the 12 V starter battery becomes weak or runs down.
- When the sensor is affected by strong light, such as direct sunlight or the headlights of an oncoming vehicle.
- The FCM may not detect a pedestrian in certain situations. Some of these include:

Forward Collision Mitigation System (FCM) (if so equipped)

**⚠ WARNING**

- If the pedestrian is shorter than approximately 3.2 feet (1 m) or taller than approximately 6.5 feet (2 m).
- If the pedestrian is wearing loose-fitting clothes.
- If part of a pedestrian's body is hidden, such as when holding an umbrella, large bag, etc.
- If a pedestrian bends forward, sits or lies on the road.
- When a pedestrian is pushing/pulling something, such as a stroller, bicycle or wheelchair.
- When pedestrians gather in a group.
- When a pedestrian clothing appears to be nearly the same color or brightness as its surroundings.
- When a pedestrian is very close to an object, such as a vehicle.
- When a pedestrian is in a dark area, such as at night or in a tunnel.
- When a pedestrian is walking fast or running.
- When a pedestrian suddenly rushes in front of the vehicle.
- When the position of a pedestrian is close to the edge of the vehicle.
- When the system recognizes driver's steering or accelerating actions as evasive actions to avoid a collision, FCM control and alarm functions may be canceled.

**⚠ WARNING**

- In certain situations, though there is little or no risk of a collision, the FCM may activate. Examples include:
  - When overtaking a vehicle.
  - When driving on a curve.
  - When there is a road side object (B) that reflects the radar sensor signal, such as a road sign.

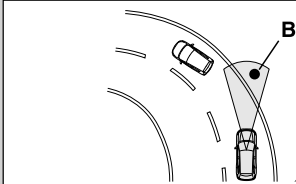

AJM104427

- When approaching a gate, a railroad crossing, an underpass, a narrow bridge, manhole lid or a speed bump.
- When driving under an overpass or pedestrian bridge.
- When driving in a narrow tunnel.
- When driving in a parking structure.
- When approaching a slope where the incline changes significantly.
- When trying to stop your vehicle very close to a vehicle or an object in front.

**⚠ WARNING**

- When passing a vehicle, a pedestrian or an object closely.

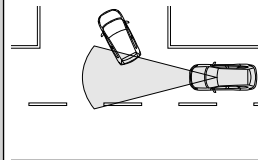

AJM104430

- When a vehicle in the next lane becomes positioned directly in front of your vehicle due to winding road conditions.

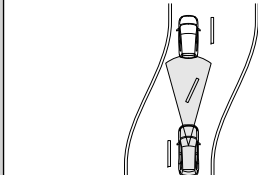

AJM104443

- When passing through an area that objects may contact the vehicle, such as thick grass, tree branches, or a banner.
- When there are patterns on the road that may be mistaken for a vehicle or a pedestrian.
- When a vehicle cuts into your path in the detecting range of the sensor.
- When an oncoming vehicle is positioned straight ahead of your vehicle on a curved road.

## Forward Collision Mitigation System (FCM) (if so equipped)

5

### ⚠ WARNING

- When the FCM detects a long object carried on your vehicle, such as skis or a roof carrier.
- When driving through fog, steam, smoke or dust.
- The FCM should be tuned off if any of following situations occur:
  - When using an automatic car wash.
  - When the tires are not properly inflated.
  - When your vehicle is towed or your vehicle tows another vehicle.
  - When your vehicle is carried on a truck.
  - When your vehicle is on a chassis dynamometer or free rollers.
  - If the windshield on or surrounding the sensor is cracked or scratched.

### 📖 NOTE

- When depressing the brake pedal while automatic braking is applied, the brake pedal will feel firm. This is normal. Depress the brake pedal harder to apply greater braking force.
- During the automatic braking, operating sounds may be heard. This is normal.

### FCM ON/OFF switch

N00577800133

This switch is used to turn on or off the FCM and also to select the distance which will trigger the forward collision warning function.

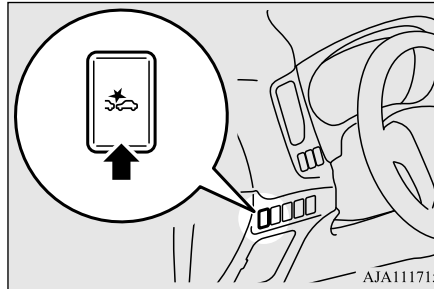

### To turn on/off the FCM

Every time the operation mode of the power switch is put in ON, the FCM will automatically be turned on.

To turn off the FCM, press and hold the FCM ON/OFF switch. The following message will appear in the multi-information display and the  indicator will come on in the instrument cluster.

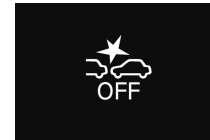

To turn on the FCM again, press and hold the FCM ON/OFF switch. The  indicator on the instrument cluster will go off, and a current distance mode for the forward collision warning will be shown in the multi-information display.





## Forward Collision Mitigation System (FCM) (if so equipped)

### To change forward collision warning distance

The distance to the vehicle ahead which triggers the forward collision warnings can be selected from three levels, “FAR”, “MIDDLE” or “NEAR”.

To change the distance mode, press the FCM ON/OFF switch. Every time the switch is pressed, the distance mode will be switched. The selected distance mode is shown on the information screen of the multi-information display.

When “FAR” is selected



When “MIDDLE” is selected



When “NEAR” is selected



#### NOTE

- Actual distance which triggers the forward collision warnings will vary depending on your vehicle speed and the front vehicle speed. The distance will become longer when the vehicle speeds are higher.
- The distance which will trigger the FCM braking function cannot be adjusted.

### System problem warning

N00594800053

If there is a malfunction in the system, a warning will appear on the information screen of the multi-information display depending on the situation.

### When the sensor cannot detect accurately

N00597600036

When the FCM system determines that its performance has been degraded, the FCM will become inoperative. This can occur when

- Foreign objects, such as dirt, snow, ice, mist or dew condensation adhere to the windshield of the sensor portion.
- In adverse weather conditions, such as rain, snow, sand storms, etc.
- A front vehicle or an oncoming vehicle is splashing water, snow or dirt.

The following message will appear on the information screen of the multi-information display and the  indicator will come on in the instrument cluster.

5



When the sensor performance returns, the FCM functions will resume operation. If the message continues showing, there is a possibility that the sensor has a malfunction. Contact a certified Mitsubishi EV dealer for inspection of the sensor.

## Forward Collision Mitigation System (FCM) (if so equipped)

### NOTE

- The “DRIVER ASSISTANCE CAMERA BLOCKED” message may temporarily appear on the information screen when the sensor cannot detect a vehicle, a pedestrian or an object within range. This is not a malfunction. When a vehicle or an object comes within range, the FCM function will resume and the message will go off.
- The “DRIVER ASSISTANCE CAMERA BLOCKED” message may appear on the information screen when driving on a non-busy road with a few vehicles and obstacles in front.

5

### When the system cannot operate temporarily

N00595100079

If the system becomes temporarily unavailable for some reason, the following message may appear on the information screen of the multi-information display, the  indicator will come on in the instrument cluster, and the FCM will automatically be turned off.



If the message continues showing, there is a possibility that the FCM has a malfunction. Contact a certified Mitsubishi EV dealer for inspection of the system.

### Sensor is too hot or cold

N00595200054

If the system becomes temporarily unavailable due to the high or low temperature of the sensor, the following message will appear on the information screen of the multi-information display, the  indicator will come on in the instrument cluster, and the FCM will automatically be turned off.



After the temperature of the sensor has been in range, the system will automatically return to operation.

If the message continues showing, there is a possibility that the FCM has a malfunction. Contact a certified Mitsubishi EV dealer for inspection of the sensor.

## Forward Collision Mitigation System (FCM) (if so equipped)

### FCM deactivation due to fault

N00595300071

If the FCM detects a malfunction in the system, either of the following messages will appear on the information screen of the multi-information display, the  indicator will come on in the instrument cluster, and the FCM will automatically be turned off.

**FCM!**

FCM  
SERVICE REQUIRED



DRIVER ASSISTANCE  
CAMERA SERVICE  
REQUIRED

If the message remains even after the operation mode of the power switch is put in OFF and then turned back to ON, please contact a certified Mitsubishi EV dealer.

### NOTE

- If the sensor or its surrounding area becomes extremely high temperature when parking the vehicle under a blazing sun, the “FCM SERVICE REQUIRED” message may appear.  
After the temperature of the sensor or its surrounding area has been in range, if the message remains even after restarting the Plug-in hybrid EV system, please contact a certified Mitsubishi EV dealer.

### Handling of the sensor

N00593400078

The sensor (A) is located inside the windshield as shown in the illustration.

The sensor is shared in the following systems:

- FCM
- Lane Departure Warning (LDW)
- Automatic High Beam (AHB)

**5**

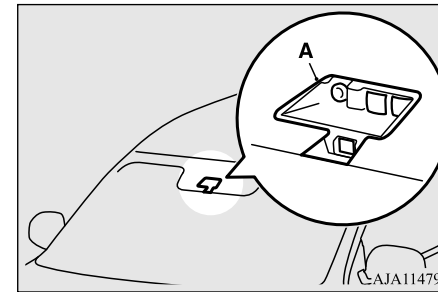

### CAUTION

- To maintain proper performance of the FCM, LDW and AHB;
  - Always keep clean the windshield.  
If the inside of the windshield where the sensor is installed becomes dirty or fogged, contact a certified Mitsubishi EV dealer.
  - Do not apply an impact or load on the sensor or its surrounding area.

## Forward Collision Mitigation System (FCM) (if so equipped)

5

### CAUTION

- Do not put anything including a sticker or film to the outer side of the windshield in front of or surrounding area of the sensor. Also, do not put anything including a sticker or film to the inner side of the windshield under the sensor.

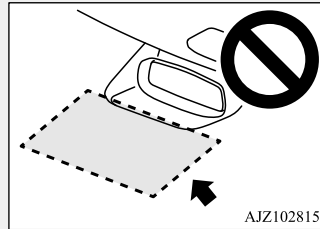

AJZ102815

- Do not attempt to detach or disassemble the sensor.
- If the windshield is misted, remove the mist from the windshield by using the defogger switch.
- Maintain the wiper blades in good condition. Refer to “Wiper blades” on page 9-44. When replacing the wiper blades, use only Mitsubishi Motors Genuine parts or equivalent.
- Do not dirty or damage the sensor.
- Do not spray glass cleaner on the sensor. Also, do not spill liquid, such as a beverage, to the sensor.
- Do not install an electronic device, such as antenna, or a device that emits strong electric waves, near the sensor.

### CAUTION

- Always use tires of the same size, same type and same brand, and which have no significant wear differences.
- Do not modify the vehicle’s suspensions.
- If the windshield on the sensor or in the surrounding area of the sensor is cracked or scratched, the sensor may not detect an object properly. This could cause a serious accident. Turn off the FCM and have your vehicle inspected as soon as possible at a certified Mitsubishi EV dealer. If you need to replace the windshield, contact a certified Mitsubishi EV dealer.
- The sensor emits infrared rays when the operation mode is in ON. Do not look into the sensor by using optical goods such as a magnifying glass. The infrared ray might injure your eyes.

### Laser radar specifications

FDA Assertion number: 1520863-000

#### Laser classification

Max average power	45 mW
Pulse duration	33 ns
Wavelength	905 nm
Divergent angle (horizon x vertical)	28° x 12°

#### Laser classification label

##### For vehicles sold in U.S.A.



##### For vehicles sold in Canada

INVISIBLE LASER RADIATION  
DO NOT VIEW DIRECTLY WITH  
OPTICAL INSTRUMENTS (MAGNIFIERS)  
CLASS 1M LASER PRODUCT

#### Laser explanatory label

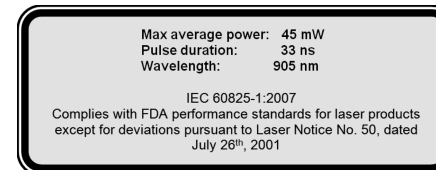

## Blind Spot Warning (BSW) (with Lane Change Assist) (if so equipped)

### Blind Spot Warning (BSW) (with Lane Change Assist) (if so equipped)

N00592200066

The Blind Spot Warning (BSW) is a driving aid system that alerts the driver when another vehicle which may not be visible through the outside rearview mirror is traveling in the next lane behind your vehicle.

When a vehicle in the next lane is traveling at same speed or faster in the detection areas, the Blind Spot Warning light in the corresponding outside rearview mirror will illuminate. If the turn signal lever is operated to the side where the Blind Spot Warning light is illuminated, the Blind Spot Warning light will blink and the system will beep three times to alert the driver.

Depending on the relative speed between your vehicle and a vehicle in the next lane, the Blind Spot Warning system will detect up to approximately 230 feet (70 m) from your vehicle. (Lane Change Assist)

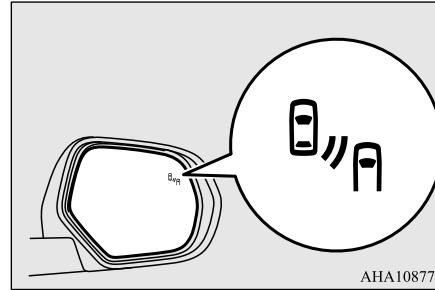

### WARNING

- Before using the BSW, read this entire section to fully understand the limitations of this system. Failure to follow instructions could result in an accident.
- Never rely solely on the BSW system when changing lanes. BSW is an aid only. It is not a substitute for your safe and careful driving. Always check visually behind and all around your vehicle for other vehicles. The performance of the BSW may vary depending on driving, traffic and/or road conditions.

### Detection areas

N00592300096

The BSW uses two sensors (A) located inside the rear bumper.

The detection areas are shown as illustrated.

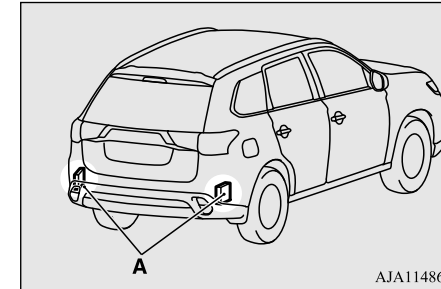

5

## Blind Spot Warning (BSW) (with Lane Change Assist) (if so equipped)

5

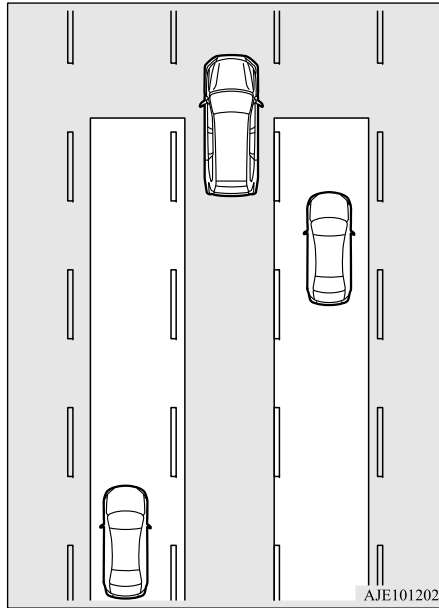

AJE101202

### ⚠ WARNING

- In certain situations, the BSW may not detect a vehicle in the detection areas or the detection may be delayed. Some of these include;
  - When a small motorcycle or a bicycle is behind your vehicle.
  - When a vehicle is traveling alongside of your vehicle at nearly the same speed for prolonged periods of time.

### ⚠ WARNING

- When the heights of the next lane and your lane are different.
- Immediately after the BSW has been turned on.
- Immediately after the power switch is turned on.
- Under adverse weather conditions, such as rain, snow, strong winds or sand storms.
- When your vehicle becomes too close to another vehicle.
- While multiple vehicle are overtaking your vehicle.
- When driving near a pot hole and tram-line.
- When a surrounding vehicle or an oncoming vehicle is splashing water, snow or dirt.
- When driving on a curve including the beginning and the end of the curve.
- When driving on a road with alternating up and down steep slopes.
- When driving on a bumpy or rough road.
- When the rear of your vehicle is weighed down or your vehicle is leaning to the right or left due to the weight of passengers and luggage or the improper adjustment of tire pressure.
- When the bumper surface around the sensor is covered with dirt, snow and ice, etc.

### ⚠ WARNING

- When the sensor is extremely hot or cold (while the vehicle is parked for a long period of time under a blazing sun or in cold weather).
- When a bicycle carrier or accessory is installed to the rear of the vehicle.

### ⚠ CAUTION

- To maintain proper performance of the BSW, follow the instructions below.
  - Always keep the bumper surface around the sensor clean.
  - Avoid impacting the sensor or its surrounding area.
  - Do not put a sticker on the sensor or its surrounding bumper surface.
  - Do not paint the sensor or its surrounding bumper surface.
  - Do not modify the sensor or its surrounding area.
- If the bumper has experienced an impact, the sensor may have been damaged and the BSW may not function properly. Have the vehicle inspected at a certified Mitsubishi EV dealer.

## To operate

N00593500154

When the BSW switch is pressed while the operation mode of the power switch is ON, the BSW indicator light in the instrument

## Blind Spot Warning (BSW) (with Lane Change Assist) (if so equipped)

cluster comes on and the BSW becomes in stand by state. When the BSW switch is pressed again, the BSW indicator light in the instrument cluster goes off and the BSW turns off.

Indicator light

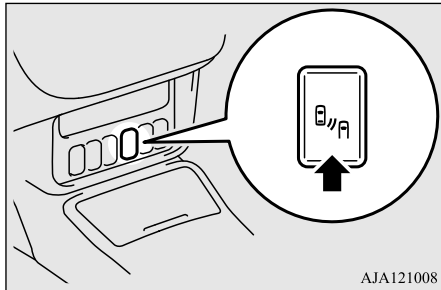

AJA121008

If you turn the BSW ON/OFF, the Rear Cross Traffic Alert (RCTA) also turns ON/OFF at the same time.

### NOTE

- When the operation mode is set to OFF, the selected condition just before setting to OFF is retained.
- The BSW operates when all of the following conditions are met.

### NOTE

- The operation mode of the power switch is put in ON.
- The select position is in positions other than “P” (PARK) and “R” (REVERSE).
- The speed of your vehicle is approximately 6 mph (10km/h) or higher.

### When the sensor detects an approaching vehicle

When the Blind Spot Warning indicator light in the instrument cluster is on, if a vehicle is approaching your vehicle in the detection area, the Blind Spot Warning light in the outside rearview mirror illuminates.

If the turn signal lever is operated to the side where the Blind Spot Warning light is illuminated, the Blind Spot Warning light will blink and the system will beep three times to alert the driver.

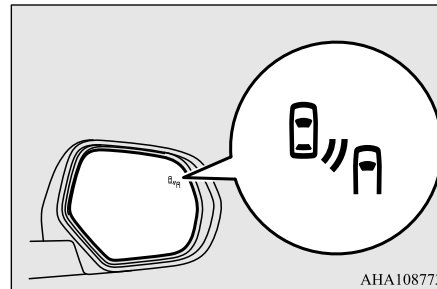

AHA108773

### NOTE

- The Blind Spot Warning light in the outside rearview mirror may come on or blink in the following conditions.
  - When driving very near the guardrail or the concrete wall.
  - When driving on the entrance and outlet of the tunnel or very near the wall or near the evacuation area inside the tunnel.
  - When turning at an intersection in a town area.
  - Under adverse weather conditions (rain, snow, sand storms etc.).
  - When your vehicle drives with blowing up the water, snow or sand etc. on the road.
  - When driving near a curb, pot hole and tramline.
- Set the BSW to OFF when towing.
- The Blind Spot Warning light in the outside rearview mirror may not be visible due to strong direct sunlight or the glare from the headlights of vehicles behind you during night driving.

5

### System problem warning

N00592400026

If a problem occurs with the system, a visual warning specific to the type of the problem is given together with an audible alarm. The warnings are combined with the “Rear Cross Traffic Alert (RCTA)” system.

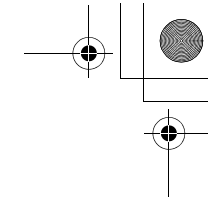
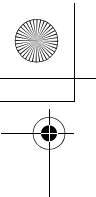

### Blind Spot Warning (BSW) (with Lane Change Assist) (if so equipped)

#### When there is a malfunction in the system or the sensor

N00592700029

**5**



When the warning display appears, the BSW does not operate normally because there are some malfunctions in the system or the sensor. Have the vehicle inspected at a certified Mitsubishi EV dealer as soon as possible.

#### NOTE

- When the warning display appears, the BSW will be deactivated.

#### When the sensor is temporarily not available

N00592800020



When the warning display appears, the sensor is temporarily not available for some reason such as the environmental condition or increase of the sensor temperature. When the warning display does not disappear after waiting for a while, contact a certified Mitsubishi EV dealer.

#### When there are foreign objects on the sensor

N00592900089



When the warning display appears, the sensor cannot detect a vehicle traveling side by side or an approaching vehicle, because foreign objects, such as dirt, snow or ice, adhere to the bumper surface around the sensor. Remove a dirt, freezing or foreign material on the bumper surface around the sensor. When the warning display does not disappear after having cleaned the bumper surface around the sensor, contact a certified Mitsubishi EV dealer.

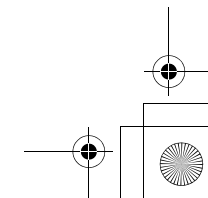
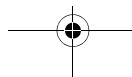
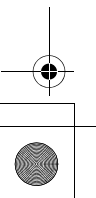
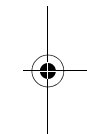
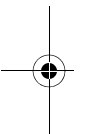



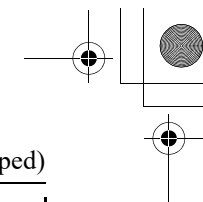
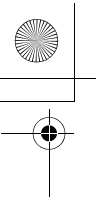

## Blind Spot Warning (BSW) (with Lane Change Assist) (if so equipped)

### General information

N00593900158

#### For vehicles sold in U.S.A.

Model: SRR3-A  
FCC ID: OAYSRR3A

This device complies with Part 15 of the FCC Rules and with Industry Canada licence-exempt RSS standard(s). Operation is subject to the following two conditions:

- (1) This device may not cause harmful interference, and
- (2) This device must accept any interference received, including interference that may cause undesired operation.

Frequency bands: 24.05 – 24.25 Ghz

The field strength of SRR3-A is below 250 millivolts/m measured at 3 metres with an average detector.

Le présent appareil est conforme aux CNR d'Industrie Canada applicables aux appareils radio exempts de licence. L'exploitation est autorisée aux deux conditions suivantes:

- (1) l'appareil ne doit pas produire de brouillage, et
- (2) l'utilisateur de l'appareil doit accepter tout brouillage radioélectrique subi, même si le brouillage est susceptible d'en compromettre le fonctionnement.

Bande de fréquence: 24.05 – 24.25 GHz

L'intensité du champ de SRR3-A est en dessous de 250 mV / m à 3 mètres mesuré avec un détecteur à valeur moyenne

#### Radiofrequency radiation exposure Information:

This equipment complies with FCC and IC radiation exposure limits set forth for an uncontrolled environment. This equipment should be installed and operated with minimum distance of 30 cm between the radiator and your body.

This transmitter must not be co-located or operating in conjunction with any other antenna or transmitter.

Cet équipement est conforme aux limites d'exposition aux rayonnements IC établies pour un environnement non contrôlé. Cet équipement doit être installé et utilisé avec un minimum de 30 cm de distance entre la source de rayonnement et votre corps.

#### FCC Notice

Changes or modifications not expressly approved by the party responsible for compliance could void the user's authority to operate the equipment.

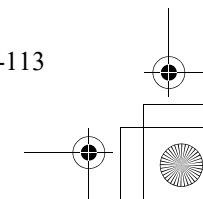
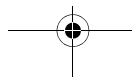
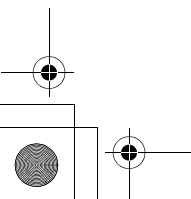

## Rear Cross Traffic Alert (RCTA) (if so equipped)

### For vehicles sold in Canada

Applicable law: RSS-210

This device contains licence-exempt transmitter(s)/receiver(s) that comply with Innovation, Science and Economic Development Canada's licence-exempt RSS(s). Operation is subject to the following two conditions:

**5**

1. This device may not cause interference.
2. This device must accept any interference, including interference that may cause undesired operation of the device.

Radiofrequency radiation exposure information:

This equipment complies with radiation exposure limits set forth for an uncontrolled environment. This equipment should be installed and operated with minimum distance of 20 cm between the radiator and your body.

### Para los vehículos vendidos en México

Certificado de homologacion:

RLVCOSR15-0442

Continental SRR3-A

Este equipo opera a título secundario, consecuentemente, debe aceptar interferencias perjudiciales incluyendo equipos de la misma clase y puede no causar interferencias a sistemas operando a título primario.

Cofetel notice:

“La operación de este equipo está sujeta a las siguientes dos condiciones:

- (1) es posible que este equipo o dispositivo no cause interferencia perjudicial y
- (2) este equipo o dispositivo debe aceptar cualquier interferencia, incluyendo la que pueda causar su operación no deseada.”

## Rear Cross Traffic Alert (RCTA) (if so equipped)

N00593000146

The Rear Cross Traffic Alert (RCTA) is an aid system for backing up. When the RCTA system detects vehicles approaching from sides while your vehicle is reversing, the Blind Spot Warning lights in outside rearview mirrors on both sides will blink and a buzzer will sound to alert the driver. A warning mes-

sage will also appear on the information screen of the multi-information display.

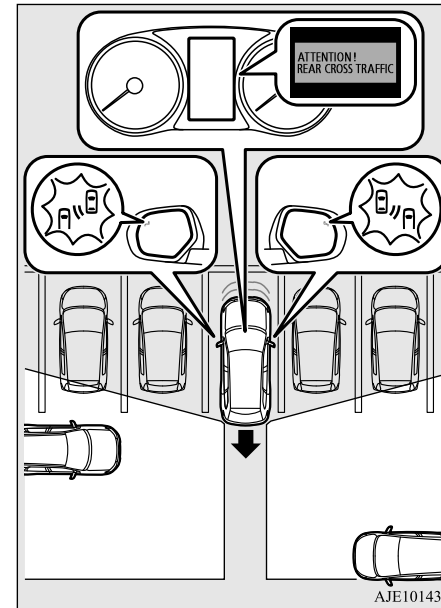

AJE101433

### WARNING

- Before using the RCTA, read this entire section to fully understand the limitations of this system. Failure to follow instructions could result in an accident.

## Rear Cross Traffic Alert (RCTA) (if so equipped)

### **⚠ WARNING**

- **Never rely solely on the RCTA when backing up. The RCTA is an aid system. It is not a substitute for your safe and careful driving. Always check visually behind and all around your vehicle for other vehicles, persons, animals or obstructions. The performance of the RCTA may vary depending on driving, traffic and/or surrounding conditions.**

### **📖 NOTE**

- The Blind Spot Warning lights in the outside rearview mirrors on both sides will blink, even when only one vehicle is approaching from one side.

### **Detection areas**

The detection area is shown as illustrated.

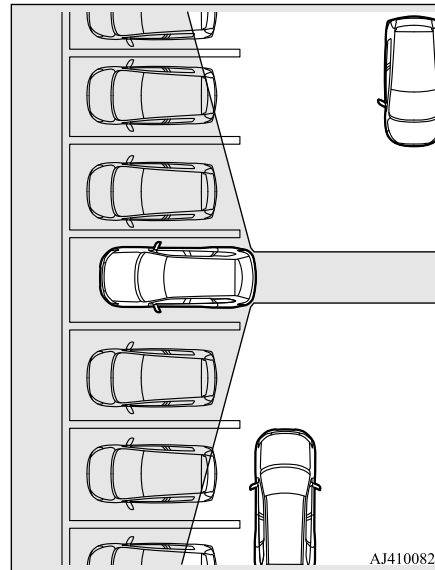

### **⚠ CAUTION**

- In certain situations, the RCTA may not detect a vehicle in the detection areas. Some of these situations include;
  - When the reversing speed of your vehicle is approximately 11 mph (18 km/h) or higher.

### **⚠ CAUTION**

- When a approaching vehicle speed is approximately 4 mph (7 km/h) or less.
- If the sensor detection area is blocked by a nearby object, such as wall or parked vehicle.
- When a vehicle is approaching from straight behind your vehicle.
- When your vehicle is exiting from an angled parking spot.

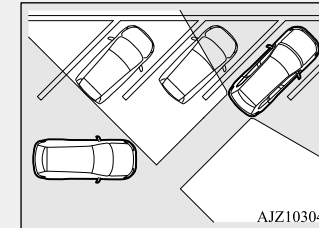

- Immediately after the RCTA has been turned on.
- Immediately after the operation mode of the power switch has been put in ON.
- When the bumper surface around the sensor is covered with dirt, snow and ice, etc.
- When the sensor becomes extremely hot or cold, such as after the vehicle has been parked for a prolonged time under the blazing sun or in cold weather.
- If the bumper has experienced an impact, the sensor may have been damaged and the RCTA may not function properly. Have the vehicle inspected at a certified Mitsubishi EV dealer.

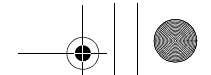

## Rear Cross Traffic Alert (RCTA) (if so equipped)

### To operate

1. Press the BSW switch while the operation mode of the power switch is put in ON.  
(Refer to “Blind Spot Warning (BSW): To operate” on page 5-110.)
2. When the select position is put in the “R” (REVERSE) position, the RCTA will operate.

5

### NOTE

- Set the RCTA to OFF when towing.
- The Blind Spot Warning light in the outside rearview mirror may not be visible due to strong direct sunlight or the glare from the headlights of vehicles behind you during night driving.



### When a problem is detected in the system

If the system detects a problem, a warning is displayed on the information screen in the multi-information display.

Refer to “Blind Spot Warning (BSW): System problem warning” on page 5-111.



5-116 Features and controls

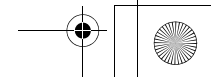
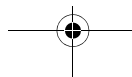

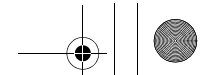

## Rear Cross Traffic Alert (RCTA) (if so equipped)

### General information

N00594000169

#### For vehicles sold in U.S.A.

Model: SRR3-A  
FCC ID: OAYSRR3A

This device complies with Part 15 of the FCC Rules and with Industry Canada licence-exempt RSS standard(s). Operation is subject to the following two conditions:

- (1) This device may not cause harmful interference, and
- (2) This device must accept any interference received, including interference that may cause undesired operation.

Frequency bands: 24.05 – 24.25 Ghz

The field strength of SRR3-A is below 250 millivolts/m measured at 3 metres with an average detector.

Le présent appareil est conforme aux CNR d'Industrie Canada applicables aux appareils radio exempts de licence. L'exploitation est autorisée aux deux conditions suivantes:

- (1) l'appareil ne doit pas produire de brouillage, et
- (2) l'utilisateur de l'appareil doit accepter tout brouillage radioélectrique subi, même si le brouillage est susceptible d'en compromettre le fonctionnement.

Bande de fréquence: 24.05 – 24.25 GHz

L'intensité du champ de SRR3-A est en dessous de 250 mV / m à 3 mètres mesuré avec un détecteur à valeur moyenne

#### Radiofrequency radiation exposure Information:

This equipment complies with FCC and IC radiation exposure limits set forth for an uncontrolled environment. This equipment should be installed and operated with minimum distance of 30 cm between the radiator and your body.

This transmitter must not be co-located or operating in conjunction with any other antenna or transmitter.

Cet équipement est conforme aux limites d'exposition aux rayonnements IC établies pour un environnement non contrôlé. Cet équipement doit être installé et utilisé avec un minimum de 30 cm de distance entre la source de rayonnement et votre corps.

#### FCC Notice

Changes or modifications not expressly approved by the party responsible for compliance could void the user's authority to operate the equipment.

5

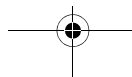

Features and controls 5-117



## Lane Departure Warning System (LDW) (if so equipped)

### For vehicles sold in Canada

Applicable law: RSS-210

This device contains licence-exempt transmitter(s)/receiver(s) that comply with Innovation, Science and Economic Development Canada's licence-exempt RSS(s). Operation is subject to the following two conditions:

**5**

1. This device may not cause interference.
2. This device must accept any interference, including interference that may cause undesired operation of the device.

Radiofrequency radiation exposure information:

This equipment complies with radiation exposure limits set forth for an uncontrolled environment. This equipment should be installed and operated with minimum distance of 20 cm between the radiator and your body.

### Para los vehículos vendidos en México

Certificado de homologación:

RLVCOSR15-0442

Continental SRR3-A

Este equipo opera a título secundario, consecuentemente, debe aceptar interferencias perjudiciales incluyendo equipos de la misma clase y puede no causar interferencias a sistemas operando a título primario.

Cofetel notice:

“La operación de este equipo está sujeta a las siguientes dos condiciones:

- (1) es posible que este equipo o dispositivo no cause interferencia perjudicial y
- (2) este equipo o dispositivo debe aceptar cualquier interferencia, incluyendo la que pueda causar su operación no deseada.”

## Lane Departure Warning System (LDW) (if so equipped)

N00577900118

The Lane Departure Warning system (LDW) is a driving aid system to help prevent unintentional lane departure. The LDW is designed to read lane markers by using a sensor (A) under certain conditions. The LDW will give you both visual and audible warnings when your vehicle is leaving or has left the lane.

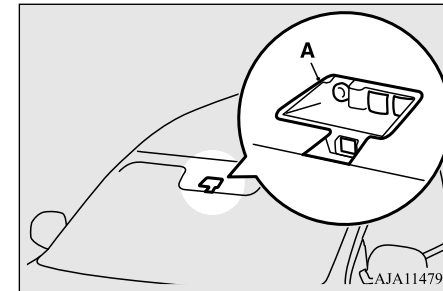

## Lane Departure Warning System (LDW) (if so equipped)

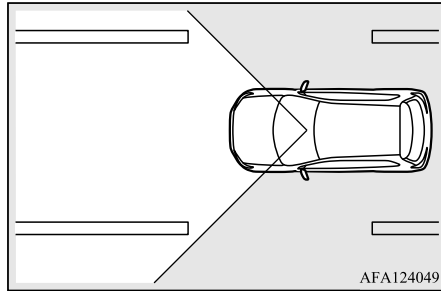

To turn on the LDW, press the LDW switch. The the “LDW” indicator will appear on the information screen of the multi information display.



### Operation of the LDW

N00581100078

The LDW, when turned ON, is capable of recognizing the lane in which your vehicle is travelling and issuing an audible warning when your vehicle begins to leave that travel lane. When operating, the “LDW” indicator on the multi-information display will be changed to  indicator (green). The LDW will not operate, however, and the “LDW” indicator will be appeared if any of following conditions have occurred:

5

### WARNING

- Never rely solely on the LDW. The LDW is not a collision avoidance system and is not a substitute for your safe and careful driving.
- Before using the LDW, read this entire section to understand the limitations of this system. Failure to follow instructions could result in an accident.

To turn off the LDW, press the LDW switch. The “LDW” indicator on the information screen of the multi information display will then go out.

To return the LDW to “ON”, press the LDW switch again.

- The vehicle speed is less than approximately 38 mph (60 km/h).
- The turn signal lever is being operated or has been operated in the past 7 seconds.
- The hazard warning light is being operated or has been operated in the past 7 seconds.

### To turn on/off the LDW

### NOTE

- The LDW is turned on when the vehicle is shipped from the factory.
- The currently selected LDW setting (on or off) is stored even when the ignition switch is turned to the “OFF” position or the operation mode is put in OFF.

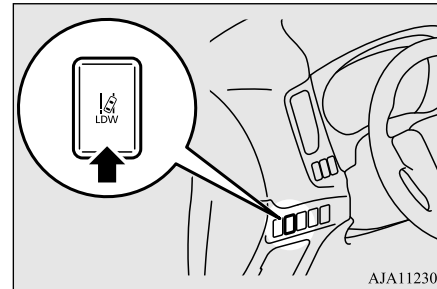

## Lane Departure Warning System (LDW) (if so equipped)

### Lane departure warning

N00581200053

While the “LDW” indicator in the information display is lit in green, if your vehicle is leaving or has left the lane, a buzzer will sound intermittently, “LANE DEPARTURE” will appear in the information display and the  indicator will be flashing in amber.

5



#### NOTE

- The warnings will not continue for more than 3 seconds, even if your vehicle continues leaving the lane.
- If the lane markers are only on one side of the road, the LDW will operate only for the appropriate side where the lane markers are drawn.

#### WARNING

- The LDW will not function when no lane marker exists, such as at an intersection or near a toll booth.

#### WARNING

- The LDW may not operate correctly in the following situations and the LDW may not give warnings or may give false warnings:
  - When lane markers are not clearly visible due to rain, snow, fog, dark area, etc.
  - When the road surface is shiny.
  - When old lane markers remain on the road surface.
  - When the lane markers are double lines or the shape of the lane markers are complicated.
  - When driving in an extremely narrow lane.
  - When the distance between your vehicle and a vehicle in front is short.
  - When driving into the sun light.
  - When driving on curves.
  - When driving on bumpy roads.
  - When driving in construction zones.
- When passing through a place where the brightness suddenly changes, such as at the entrance to or exit of a tunnel.
- When the headlights of an oncoming vehicle are very bright.
- When the rear of your vehicle is weighed down with the weight of passengers and luggage.
- When the headlights of your vehicle are not clean or are not properly aimed.
- When the front windshield is not clean.
- When the front windshield wipers do not clean the windshield properly.

#### CAUTION

- To maintain proper function of the LDW:
  - Always keep the windshield and the headlights clean.
  - Do not put anything, such as a sticker, on the front windshield in front of the sensor.
  - Avoid applying a shock or load to the sensor.
  - Do not attempt to detach or disassemble the sensor.
  - Use only Mitsubishi Motors Genuine parts when replacing the windshield wipers.

#### NOTE

- When driving conditions are not suitable to use the LDW, turn off the LDW.

### System problem warning

N00578100032

If a problem occurs with the system, a visual warning specific to the type of the problem is given together with an audible alarm.



## Lane Departure Warning System (LDW) (if so equipped)

### Sensor is too hot or cold

The alarm shown below is displayed if the system becomes temporarily unavailable due to the high or low temperature of the sensor. After temperature of the sensor has been in range, the system will automatically return to operation. If the alarm continues showing, there is a possibility that the LDW has a malfunction. Contact a certified Mitsubishi EV dealer for inspection of the system.



### Windshield is dirty

The alarm shown below is displayed if the system becomes temporarily unavailable due to the dirty windshield of the sensor. After having cleaned the windshield, the system will automatically return to operation. If the alarm continues showing, there is a possibility that the LDW has a malfunction. Contact a certified Mitsubishi EV dealer for inspection of the sensor.



### LDW deactivation due to fault

If the LDW is deactivated due to a malfunction in the system, the either alarm shown below is displayed. Contact a certified Mitsubishi EV dealer for inspection of the system.

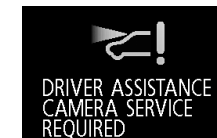

5

### NOTE

- If the sensor or its surrounding area becomes extremely high temperature when parking the vehicle under a blazing sun, the “LDW SERVICE REQUIRED” message may appear. If the message remains even after the temperature of the sensor or its surrounding area has been in range, please contact a certified Mitsubishi EV dealer.

## Tire pressure monitoring system (TPMS)

### Tire pressure monitoring system (TPMS)

N00530201700

The tire pressure monitoring system (TPMS) uses tire inflation pressure sensors (A) on the wheels to monitor the tire inflation pressures.

5

The system only indicates when a tire is significantly under-inflated.

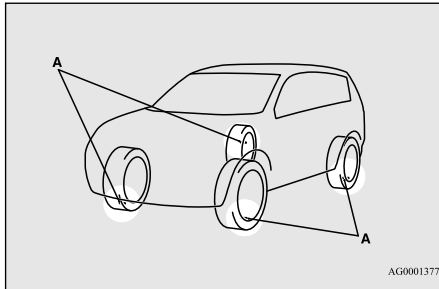

#### NOTE

- The TPMS is not a substitute for regularly checking tire inflation pressures. Be sure to check the tire inflation pressures as described in “Tires” on page 9-12.
- The tire inflation pressure sensor (A) is installed in the illustrated location.
  - On vehicles with Type 1 sensor which has the metallic air valve (B), replace grommet and washer (C) with the new ones when the tire is replaced.

#### NOTE

- On vehicles with Type 2 sensor which has the rubber air valve (D), replace rubber air valve (D) with new one when the tire is replaced.

For details, please contact a certified Mitsubishi EV dealer.

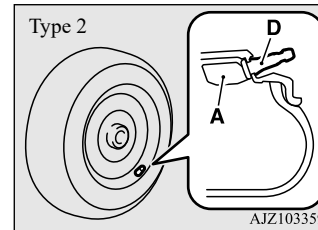
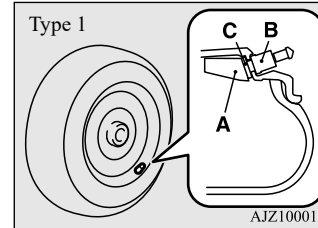

#### TPMS warning light / display

N00532701392



When the operation mode is put in ON, the TPMS warning light normally illuminates and goes off a few seconds later.

If one or more of the vehicle tires is significantly under-inflated, the warning light will remain illuminated while the operation mode is put in ON.

Refer to “If the warning light / display illuminates while driving” on page 5-123 and take the necessary measures.

#### NOTE

- In addition, the warning display is displayed on the information screen in the multi-information display.



#### CAUTION

- If the TPMS warning light does not illuminate when the operation mode is put in ON, it means that the TPMS is not working properly. Have the system inspected by a certified Mitsubishi EV dealer. In such situations, a malfunctioning of the system may be preventing the monitoring of the tire pressure. Avoid sudden braking, sharp turning and high-speed driving.

**CAUTION**

- If a malfunction is detected in the TPMS, the TPMS warning light will blink for approximately 1 minute and then remain continuously illuminated. The warning light will issue further warnings each time the Plug-in Hybrid EV system is restarted as long as the malfunction exists.

Check to see whether the warning light goes off after few minutes driving.

If it then goes off during driving, there is no problem.

However, if the warning light does not go off, or if it blinks again when the Plug-in Hybrid EV system is restarted, have the vehicle inspected by a certified Mitsubishi EV dealer.

In such situations, a malfunctioning of the system may be preventing the monitoring of the tire pressure. For safety reasons, when the warning light appears while driving, avoid sudden braking, sharp turning and high-speed driving.

**NOTE**

- In addition, the warning display is displayed on the information screen in the multi-information display.



Each tire, should be checked monthly when cold and inflated to the inflation pressure recommended by the vehicle manufacturer on the vehicle placard or tire inflation pressure label. (If your vehicle has tires of a different size than the size indicated on the vehicle placard or tire inflation pressure label, you should determine the proper tire inflation pressure for those tires.)

As an added safety feature, your vehicle has been equipped with a TPMS that illuminates a low tire pressure telltale when one or more of your tires is significantly under-inflated.

Accordingly, when the low tire pressure telltale illuminates, you should stop and check your tires as soon as possible, and inflate them to the proper pressure. Driving on a significantly under-inflated tire causes the tire to overheat and can lead to tire failure.

Under-inflation also reduces fuel efficiency and tire tread life, and may affect the vehicle's handling and stopping ability. Please note that the TPMS is not a substitute for proper tire maintenance, and it is the driver's responsibility to maintain correct tire pressure, even if under-inflation has not reached the level to trigger illumination of the TPMS low tire pressure telltale.

Your vehicle has also been equipped with a TPMS malfunction indicator to indicate when the system is not operating properly. The

**Tire pressure monitoring system (TPMS)**

TPMS malfunction indicator is combined with the low tire pressure telltale.

When the system detects a malfunction, the telltale will flash for approximately one minute and then remain continuously illuminated. This sequence will continue upon subsequent vehicle start-ups as long as the malfunction exists.

When the malfunction indicator is illuminated, the system may not be able to detect or signal low tire pressure as intended.

TPMS malfunctions may occur for a variety of reasons, including the installation of replacement or alternate tires or wheels on the vehicle that prevent the TPMS from functioning properly. Always check the TPMS malfunction telltale after replacing one or more tires or wheels on your vehicle to ensure that the replacement or alternate tires and wheels allow the TPMS to continue to function properly.

**If the warning light / display illuminates while driving**

N00532801582

1. If the TPMS warning light illuminates, avoiding hard braking, sharp steering maneuvers and high speeds. You should stop and adjust the tires to the proper inflation pressure as soon as possible. Refer to "Tires" on page 9-12.

## Tire pressure monitoring system (TPMS)

5

 **NOTE**

- In addition, the warning display is displayed on the information screen in the multi-information display.
- When inspecting or adjusting the tire pressure, do not apply excessive force to the valve stem to avoid breakage.
- After inspecting or adjusting the tire pressure, always reinstall the valve cap on the valve stem.  
Without the valve cap, dirt or moisture could get into the valve, resulting in damage to the tire inflation pressure sensor.
- Do not use metal valve caps, which may cause a metal reaction, resulting in corrosion and damage of the tire inflation pressure sensors.
- Once adjustments have been made, the warning light will go off after a few minutes of driving.

- If the TPMS warning light remains illuminated after you have been driving for approximately 20 minutes after you adjust the tire inflation pressure, one or more of the tires may have a puncture. Inspect the tire and if it has a puncture, have it repaired by a certified Mitsubishi EV dealer as soon as possible.

 **WARNING**

- **If the warning light / display illuminates while you are driving, avoid hard braking, sharp steering maneuvers and high speeds.  
Driving with an under-inflated tire adversely affects vehicle performance and can result in an accident.**

 **CAUTION**

- The warning light / display may not illuminate immediately in the event of a tire blow-out or rapid leak.

 **NOTE**

- To avoid the risk of damage to the tire inflation pressure sensors, have any punctured tire repaired by a certified Mitsubishi EV dealer. If the tire repair is not done by a certified Mitsubishi EV dealer, it is not covered by your warranty.
- Do not use an aerosol puncture-repair spray on any tire.  
Such a spray could damage the tire inflation pressure sensors.
- Using the tire repair kit may damage the tire inflation pressure sensor. The vehicle must promptly be inspected and repaired by a certified Mitsubishi EV dealer after using the tire repair kit.

The TPMS may not work normally in the following circumstances:

- A wireless facility or device using the same frequency is near the vehicle.
- Snow or ice is stuck inside the fenders and/or on the wheels.
- The tire inflation pressure sensor's battery is dead.
- Wheels other than Mitsubishi Motors Genuine wheels are being used.
- Wheels that are not fitted with tire inflation pressure sensors are being used.
- Wheels whose ID codes are not memorized by the vehicle are used.
- A window tint that affects the radio wave signals is installed.

 **NOTE**

- Tire inflation pressures vary with the ambient temperature. If the vehicle is subjected to large variations in ambient temperature, the tire inflation pressures may be under-inflated (causing the warning light / display come on) when the ambient temperature is relatively low. If the warning light / display comes on, adjust the tire inflation pressure.

## Whenever the tires and wheels are replaced with new ones

N00532901219

If new wheels with new tire inflation pressure sensors are installed, their ID codes must be programmed into the TPMS. Have tire and wheel replacement performed by a certified Mitsubishi EV dealer to avoid the risk of damaging the tire inflation pressure sensors. If the wheel replacement is not done by a certified Mitsubishi EV dealer, it is not covered by your warranty.

### CAUTION

- The use of non-genuine wheels will prevent the proper fit of the tire inflation pressure sensors, resulting air leakage or damage of the sensors.

## Tire ID set change

N00584300055

In case that 2 sets of tire inflation pressure sensor ID are registered in the receiver, the valid tire ID set can be changed by following procedure.

1. Operate the multi-information display switch to switch the information screen to the menu screen.

Refer to “Multi-information display switch” on page 5-142.

Refer to “Changing the function settings” on page 5-153.

2. Lightly press the multi-information display switch to select “ 1 - 2” (tire ID set change).
3. Hold down the multi-information display switch for approximately 3 seconds or more. The setting changes to the selected tire ID set.

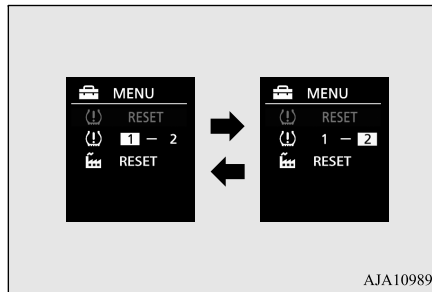

4. The valid tire ID set is changed, and the number of the TPMS SET indicator is changed.

### NOTE

- Each time this procedure is done, the tire ID set is changed. (1 - 2 - 1 - 2 ...)
- The tire ID set is NOT changed, in case that only 1 set of ID is registered.

## Tire pressure monitoring system (TPMS)

### General information

N00533001291

Your TPMS operates on a radio frequency subject to Federal Communications Commission (FCC) Rules (For vehicles sold in U.S.A.) and Industry Canada Rules (For vehicles sold in Canada). This device complies with part 15 of FCC Rules and Industry Canada licence-exempt RSS standard(s).

5

Operation is subject to the following two conditions.

- This device may not cause harmful interference.
- This device must accept any interference received, including interference that may cause undesired operation.

### CAUTION

- Changes or modifications not expressly approved by the manufacturer for compliance could void the user's authority to operate the equipment.

## Rear-view camera (if so equipped)

### Para los vehículos vendidos en México

La operación de este equipo está sujeta a las siguientes dos condiciones: (1) es posible que este equipo o dispositivo no cause interferencia perjudicial y (2) este equipo o dispositivo debe aceptar cualquier interferencia, incluyendo la que pueda causar su operación no deseada.

**5**

TIS-10DH  
 IFETEL: RLVCOI19-0222  
 Continental

## Rear-view camera (if so equipped)

N00546201415

When the select position is in the “R” (REVERSE) position with the operation mode of the power switch in ON, the rear-view image will be displayed on the screen of the Smartphone-link Display Audio (SDA). When the select position is shifted out of the “R” (REVERSE) position, the rear-view image will go off.

## ⚠ WARNING

- **Never rely solely on the rear-view camera to clear the area behind your vehicle. Always check visually behind and all around your vehicle for persons, animals, obstructions or other vehicles. Failure to do so can result in vehicle damage, serious injury or death.**
- **The rear-view camera is an aid system for backing up, but it is not a substitute for your visual confirmation.**
- **The view on the screen is limited, and objects outside the view, such as under the bumper or around either corner of the bumper end, cannot be seen on the screen.**

## ⚠ CAUTION

- If the camera lens gets dirty, a clear image cannot be obtained. As necessary, rinse the lens with clean water and gently wipe with a clean, soft cloth.
- To avoid damaging the camera;
  - Do not rub the cover excessively or polish it by using an abrasive compound.
  - Do not disassemble the camera.
  - Do not splash hot water directly on the lens.
  - Do not spray the camera and its surroundings with high-pressure water.
  - Make sure that the liftgate is securely closed when backing up.

## Location of rear-view camera

The rear-view camera (A) is in the liftgate, at the left side of the liftgate handle.

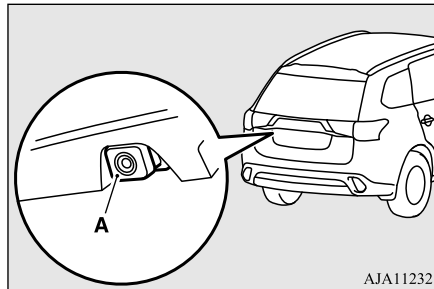

## Reference lines on the screen

Reference lines and upper surface of the rear bumper (A) are displayed on the screen.

- Red line (B) indicates approximately 20 inches (50 cm) behind the rear bumper.
- Two Green lines (C) indicate approximately 8 inches (20 cm) outside of the vehicle body.
- Short transverse lines (1 to 3) indicate distance from the rear bumper.

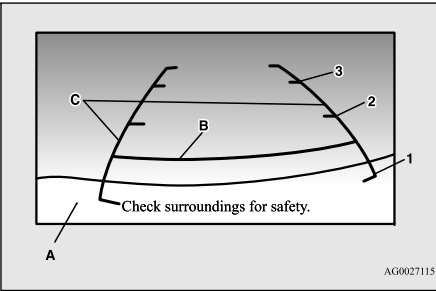

- 1: Approximately at the rear edge of the rear bumper (if so equipped)
- 2: Approximately 39 inches (100 cm)
- 3: Approximately 79 inches (200 cm)

### CAUTION

- The rear-view camera uses a wide-angle lens. As a result, images and distances shown on the screen are not exact.
- Never rely solely on the reference lines. The reference lines indicating distance and vehicle width are based on a level, flat road surface. Actual distance may be different from distance indicated by the lines on the screen, depending on the loading condition of the vehicle and road surface condition. Also, your vehicle width indicated by the reference lines may be different from the actual vehicle width.

For example;

### CAUTION

In the following cases, objects shown on the screen will appear to be farther off than they actually are.

- When the rear of the vehicle is weighed down with the weight of passengers and luggage in the vehicle.

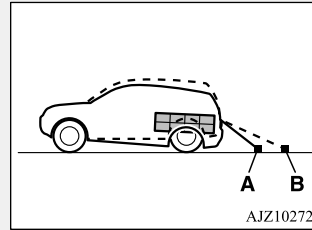

A: Actual objects  
B: Objects shown on the screen

- When there is an upward slope behind the vehicle.

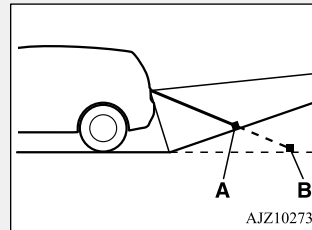

A: Actual objects  
B: Objects shown on the screen

### Rear-view camera (if so equipped)

### CAUTION

- When there is a downward slope behind the vehicle, objects shown on the screen will appear to be closer than they actually are.

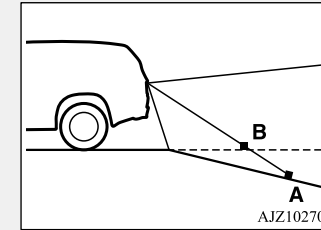

A: Actual objects  
B: Objects shown on the screen

## Multi Around Monitor (if so equipped)

5

### CAUTION

- When the vehicle is approaching a truck, the reference lines indicate that your vehicle will clear the truck. In reality, the truck is in your path.

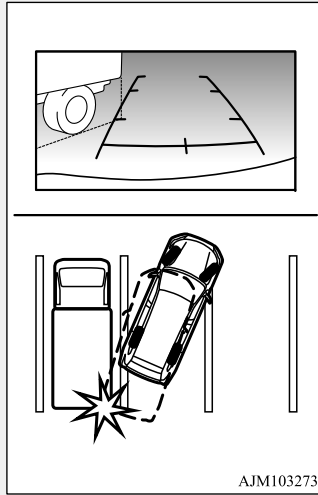

### CAUTION

- When there is an object behind the vehicle that has upper sections projecting in the direction of the vehicle, the reference lines on the screen will indicate that point A is the farthest point and point B is the closest point to the vehicle. In reality, point A and B are actually the same distance from the vehicle, and point C is farther off than point A and B.

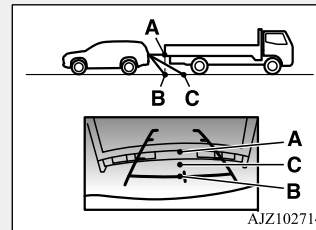

### NOTE

- Mirror image is displayed on the screen.
- The display language of the screen is possible to be changed.  
For details, please refer to the separated owner's manual.
- Under certain circumstances, it may become difficult to see an image on the screen, even when the system is functioning correctly.
  - In a dark area, such as at night.
  - When water drops or condensation are on the lens.

### NOTE

- When sun light or headlights shine directly into the lens.

## Multi Around Monitor (if so equipped)

N00587200084

The Multi Around Monitor system uses four cameras, “Front-view camera”, “Side-view cameras (right and left)” and “Rear-view camera”, and displays composite views from those cameras on a screen in the Smartphone-link Display Audio (SDA).

The Multi Around Monitor system will assist the driver to park the vehicle in a narrow or parallel parking space.

### WARNING

- **Before using the Multi Around Monitor system, read this entire section to fully understand the limitations of this system. Failure to follow instructions could result in an accident.**
- **The Multi Around Monitor system is an aid system to help observe around the vehicle. It is not a substitute for your visual confirmation.**
- **Never rely solely on the Multi Around Monitor system. The view on the screen is limited, and objects outside the view cannot be seen on the screen.**



## Multi Around Monitor (if so equipped)

### ⚠ CAUTION

- Before using the Multi Around Monitor, make sure that all doors and the liftgate are closed and the outside mirrors are unfolded. If an outside mirror is folded and/or if a front door and/or the liftgate is open, the areas displayed on the Multi Around Monitor will not be appropriate.

### Location of each camera

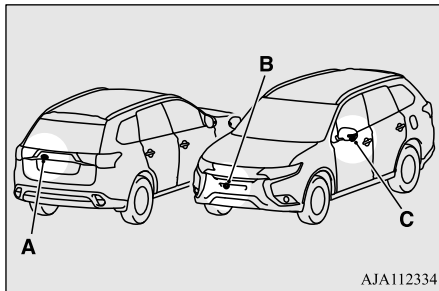

- A- Rear-view camera
- B- Front-view camera
- C- Side-view camera

### ⚠ CAUTION

- If the camera lens gets dirty, a clear image cannot be obtained. As necessary, rinse the lens with clean water and gently wipe with a clean, soft cloth.

### ⚠ CAUTION

- To avoid damaging the camera;
  - Do not rub the cover excessively or polish it by using an abrasive compound.
  - Do not disassemble the camera.
  - Do not splash hot water directly on the lens.
  - Do not spray the camera and its surroundings with high-pressure water.
  - Make sure that the liftgate is securely closed when backing up.
- Do not attach anything on the camera and/or surrounding areas. Doing so will disturb the camera.

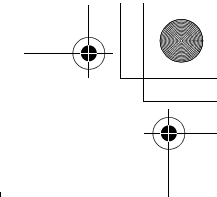
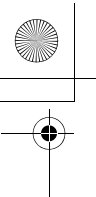

## Multi Around Monitor (if so equipped)

### Range of view of the Multi Around Monitor

N00587300027

The range of view of the Multi Around Monitor cameras is limited to the area shown in the illustrations. It cannot show around the both sides and the lower part of the front and rear bumpers, etc. While driving, be sure to visually confirm safety around the vehicle.

### Range of view of the Multi Around Monitor cameras

5

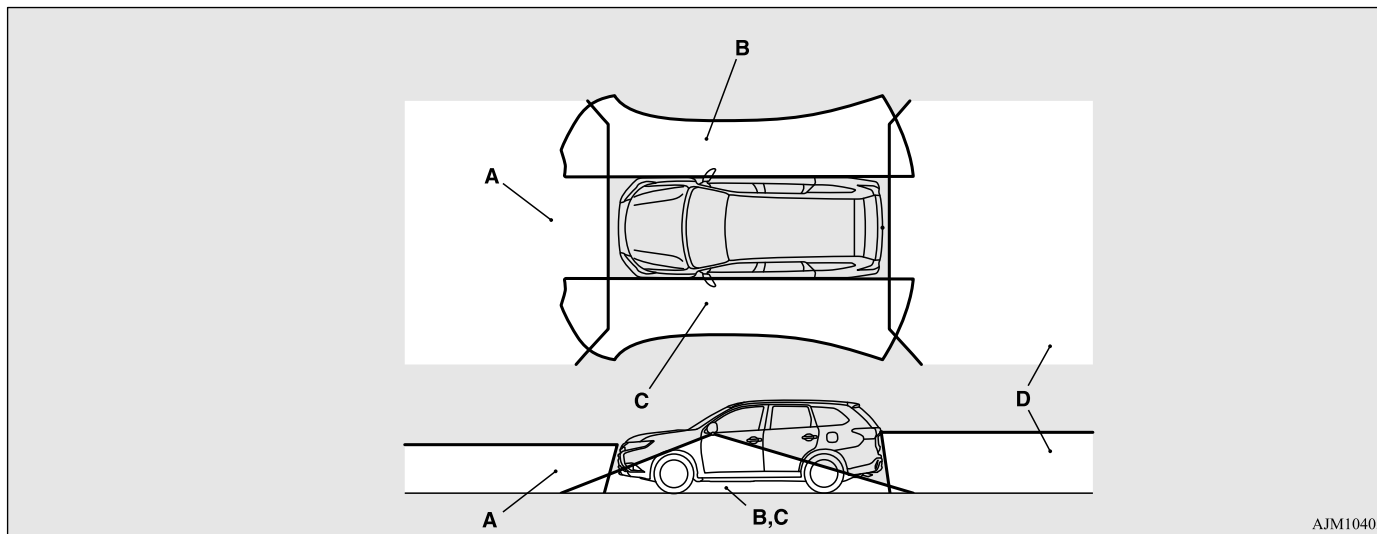

AJM104052

- A: Front-view camera
- B: Side-view camera (Right)
- C: Side-view camera (Left)
- D: Rear-view camera

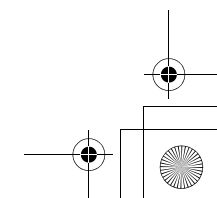
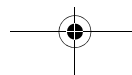
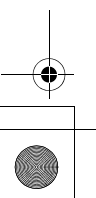

## Multi Around Monitor (if so equipped)

### Types of views of the Multi Around Monitor

N00587400073

Two different types of views are displayed on the left side and the right side respectively.

#### Bird's eye-view/Rear-view mode

Views of the surroundings of the vehicle and behind the vehicle are displayed.

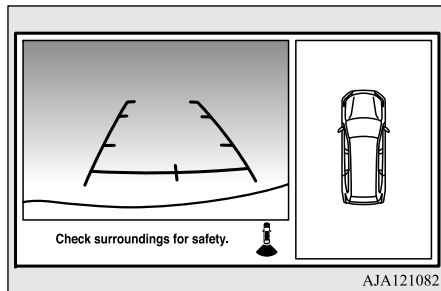

#### Side-view/Rear-view mode

Views of the passenger's side of the vehicle and behind the vehicle are displayed.

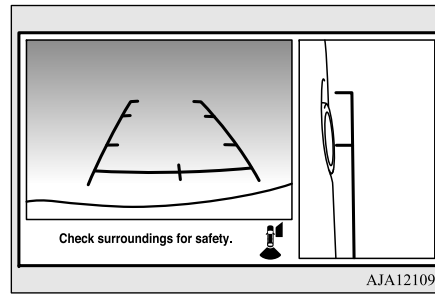

#### Bird's eye-view/Front-view mode

Views of the surroundings of the vehicle and the front of the vehicle are displayed.

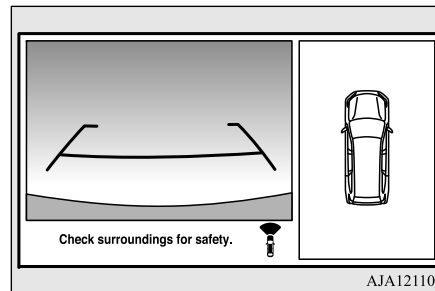

#### Side-view/Front-view mode

Views of the passenger's side of the vehicle and the front of the vehicle are displayed.

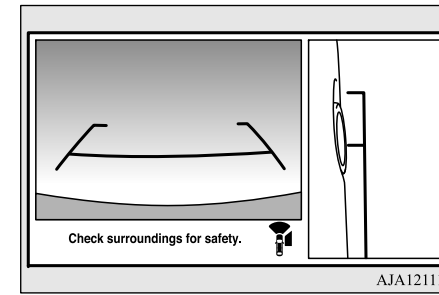

5

#### CAUTION

- The camera uses a special lens. As a result, images and distances shown on the screen are not exact.

#### NOTE

- Because the cameras have a special lens, the lines on the ground between parking spaces may not look parallel on the screen.
- Under certain circumstances, it may become difficult to see an image on the screen, even when the system is functioning correctly.
  - In a dark area, such as at night.

5

## Multi Around Monitor (if so equipped)

### NOTE

- When water drops or condensation are on the lens.
- When sun light or headlights shine directly into the lens.
- When a fluorescent light shines directly into the lens.
- If the atmospheric temperature is extremely hot or extremely cold, the camera images may not be clear. There is no abnormality.
- If a wireless device is installed near the camera, the camera images may cause electrical system interference and the system may stop functioning properly.

### How to use the Multi Around Monitor

N00587500087

The Multi Around Monitor can only be used when the operation mode of the power switch is put in ON.

### Operation with the selector lever

When you place the select position is the “R” (REVERSE) position, the bird’s eye-view/rear-view is displayed on the screen of the SDA. When you move the selector lever to any other position, the display disappears.

### NOTE

- The passenger’s side screen can be switched to the side-view by pressing the camera switch.

### Operation with the switch

When the camera switch (A) is pressed, the bird’s eye-view/front-view is displayed.

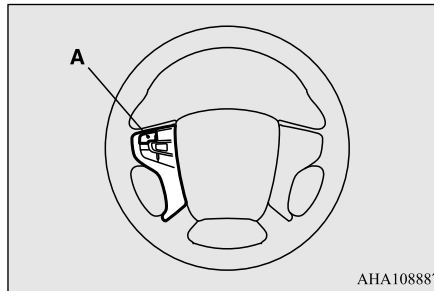

AHA108887

### NOTE

- If there is no operation for 3 minutes after the Multi Around Monitor is displayed by pressing the switch with the select position in other than “R” (REVERSE), the display disappears.

### Switching of the screen (Select position is “R” (REVERSE))

If the camera switch is pressed, the mode of Multi Around Monitor is switched, Bird’s eye-view/Rear-view mode → Side-view/Rear-view mode

### Switching of the screen (Select position is other than “R” (REVERSE))

If the camera switch is pressed, the mode of Multi Around Monitor is switched, Bird’s eye-view/Front-view mode → Side-view/Front-view mode → OFF

### NOTE

- When you place the select position is the “R” (REVERSE) position with the front-view mode displayed on the driver’s side screen, the driver’s side screen switches to the rear-view mode. When you shift the select position to any other position, the driver’s side screen switches to the front-view mode.
- When the camera switch is pressed at the vehicle speed of approximately 6 mph (10 km/h) or higher, only the side-view can be displayed on the passenger’s side screen.

**NOTE**

- The front-view will not be displayed when the vehicle speed exceeds approximately 6 mph (10 km/h).
- The display of the view may be delayed during switching of the screen.

**How to read the screen**

N00587600062

In any mode other than the Bird's eye-view mode, the lines in the screen give the following information. Use them only as a guide.

**CAUTION**

- If the camera and/or its surrounding area have experienced an impact, the Multi Around Monitor system may not function correctly. Have the vehicle inspected by a certified Mitsubishi EV dealer.

**Front-view mode**

Reference lines for the distance and the vehicle width and upper surface of the front bumper (A) are displayed on the screen.

- The Red line (B) indicates approximately 20 inches (50 cm) from the front edge of the front bumper.

- The Two Green lines (C) indicate the approximate vehicle width.
- The Orange lines (D) indicates an expected course when the vehicle moves forward with the steering wheel turned. It disappears when the steering wheel is in the neutral position.
- The approximate distance from the vehicle body is as follows:

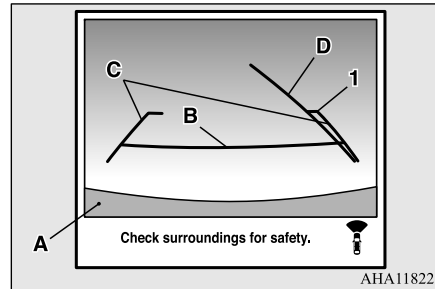

- 1- Approximately 39 inches (100 cm) from the front edge of the front bumper

**NOTE**

- When the expected course lines are displayed in the front-view, the expected course lines are also displayed in the bird's eye-view (Front: solid line, Rear: broken line).

**Multi Around Monitor (if so equipped)**

**NOTE**

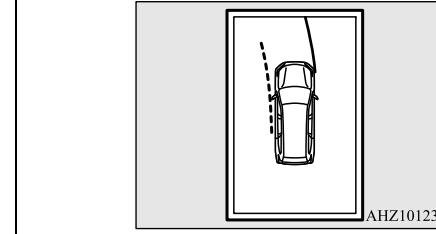

5

**Rear-view mode**

N00587700047

Reference lines for the distance and the vehicle width and upper surface of the rear bumper (A) are displayed on the screen.

- The Red line (B) indicates approximately 20 inches (50 cm) behind the rear edge of the rear bumper.
- The Two Green lines (C) indicate the approximate vehicle width.
- The Orange line (D) indicates an expected course when the vehicle is reserved with the steering wheel turned. It disappears when the steering wheel is in the neutral position.
- The approximate distance from the vehicle body is as follows:

## Multi Around Monitor (if so equipped)

5

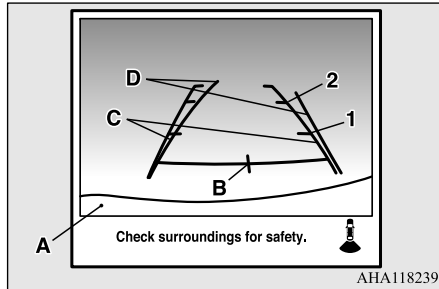

- 1- Approximately 39 inches (100 cm) from the rear edge of the rear bumper
- 2- Approximately 79 inches (200 cm) from the rear edge of the rear bumper

### CAUTION

- The rear-view camera uses a wide-angle lens. As a result, images and distances shown on the screen are not exact.
- Never rely solely on the reference lines. The reference lines indicating distance and vehicle width are based on a level, flat road surface. Actual distance may be different from distance indicated by the lines on the screen, depending on the loading condition of the vehicle and road surface condition. Also, your vehicle width indicated by the reference lines may be different from the actual vehicle width.

For example;

5-134 Features and controls

### CAUTION

In the following cases, objects shown on the screen will appear to be farther off than they actually are.

- When the rear of the vehicle is weighed down with the weight of passengers and luggage in the vehicle.

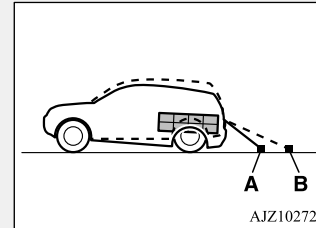

- A: Actual objects
- B: Objects shown on the screen

- When there is an upward slope behind the vehicle.

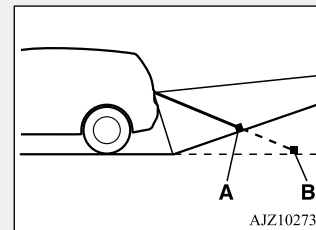

- A: Actual objects
- B: Objects shown on the screen

### CAUTION

- When there is a downward slope behind the vehicle, objects shown on the screen will appear to be closer than they actually are.

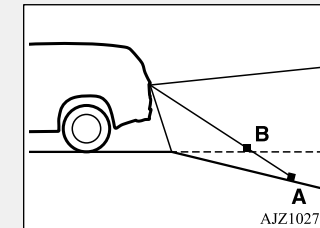

- A: Actual objects
- B: Objects shown on the screen

### Multi Around Monitor (if so equipped)

#### ⚠ CAUTION

- When the vehicle is approaching a truck, the reference lines indicate that your vehicle will clear the truck. In reality, the truck is in your path.

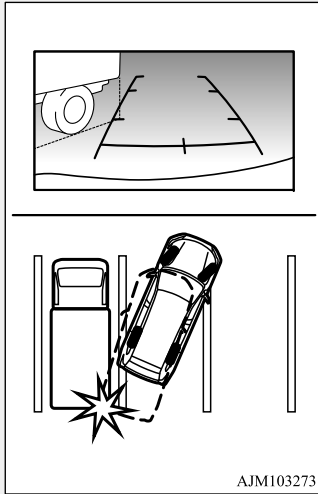

#### ⚠ CAUTION

- When there is an object behind the vehicle that has upper sections projecting in the direction of the vehicle, the reference lines on the screen will indicate that point A is the farthest point and point B is the closest point to the vehicle. In reality, point A and B are actually the same distance from the vehicle, and point C is farther off than point A and B.

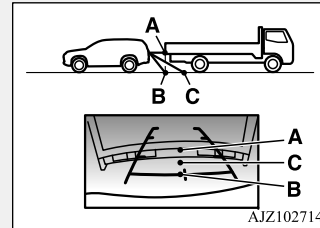

#### 📖 NOTE

- When the expected course lines are displayed in the rear-view, the expected course lines are also displayed in the bird's eye-view (Front: broken line, Rear: solid line).

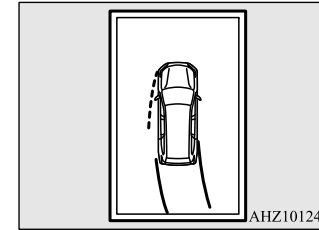

5



## Multi Around Monitor (if so equipped)

### Side-view mode

N00587900023

Reference lines for the vehicle width and the front end of the vehicle are displayed on the screen.

**5**

- 1- Approximate vehicle width including the door mirror.
- 2- Approximate location of the axle center of the front wheel.
- 3- Approximate 20 inches (50 cm) from the front edge of the front bumper.

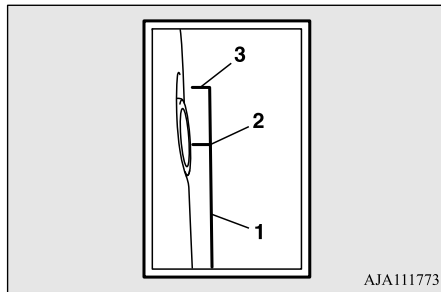

### Bird's eye-view mode

N00588000021

An overhead view in which the vehicle is looked down is displayed so that you can easily identify the location of your vehicle and the course to enter the parking space.

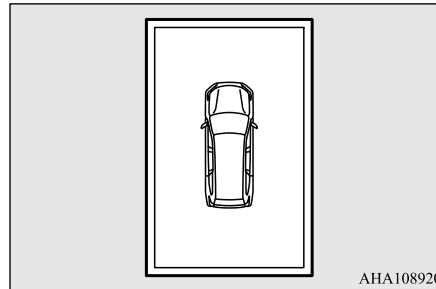

### CAUTION

- The bird's eye-view is a composite image from images captured by the "Front-view camera", "Side-view cameras (right and left)" and "Rear-view camera". As a result, objects may appear to be farther away than they actually are. Also, an object may appear to be in a direction and/or location different from actual. In addition, blind spots exist in proximity of the vehicle. Even if the screen indicates that there is a space between your vehicle and an object, there may actually be less or no space. Always check visually behind and all around your vehicle.
- The view at a section near each corner on the Bird's eye-view is combined from the edge of the view captured by each camera. As a result, an object indicated in the section may be unclear, and it may disappear/reappear on the screen.

### NOTE

- In the Bird's eye-view mode, since the views captured by the four cameras, "Front-view camera", "Side-view cameras (right and left)" and "Rear-view camera" are processed based on a level flat road surface, an image may be displayed as follows:
  - An object appears to have fallen down and looks longer or larger.

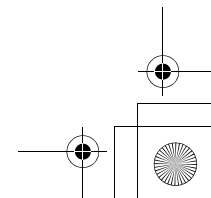
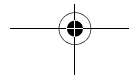
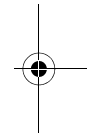
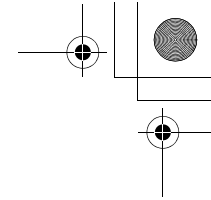
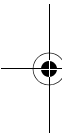



## Instrument cluster

### NOTE

- An object having a height from the road surface may seem to appear from the joint of the view composition processing regions.
- The brightness of the views from each camera may vary depending on the illuminance conditions.
- An object above the camera is not displayed.
- The object displayed in the Front-view mode or the Rear-view mode may not be displayed in the Bird's eye-view mode.
- The view in the Bird's eye-view mode may be displaced from its true position when the mounting location and angle of each camera are changed.
- The lines on the road may appear to be displaced or bent at the joint of the views.

### Instrument cluster

N00519001457

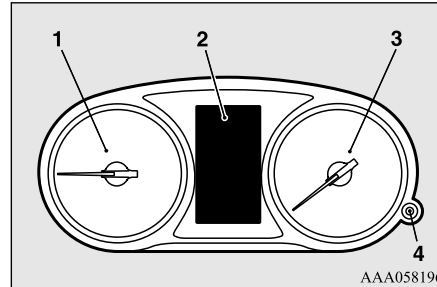

AAA058196

- 1- Energy usage indicator → P.5-138
- 2- Multi-information display → P.5-140  
Information screen display list  
→ P.5-161
- 3- Speedometer → P.5-137
- 4- Rheostat illumination button  
→ P.5-139

### Speedometer

N00519101298

The speedometer shows the vehicle speed in miles per hour (mph) or kilometers per hour (km/h).

#### Type A

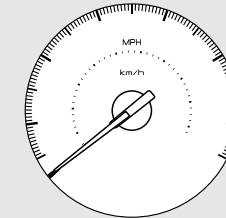

AJA112800

5

#### Type B

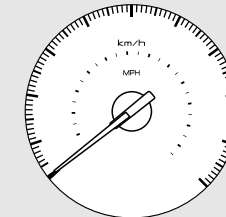

AJA112813

Features and controls 5-137

Instrument cluster

**Energy usage indicator**

N00572101066

**5**

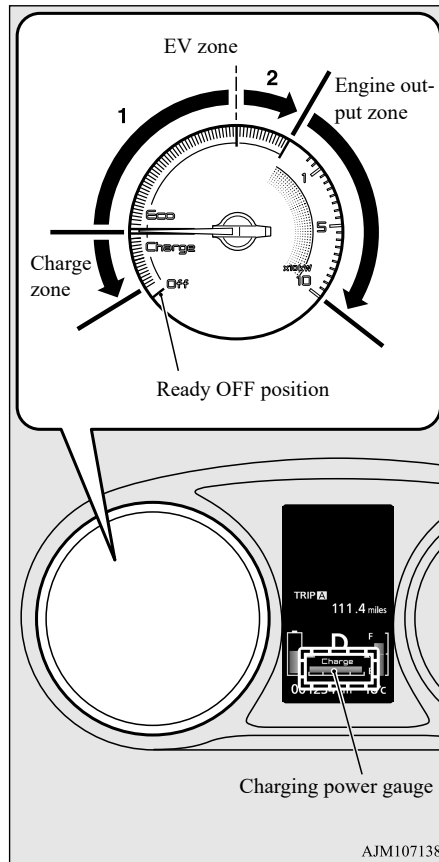

**Ready OFF position**

Indicates that the vehicle cannot be driven (READY OFF).

When the vehicle is ready for running, the needle of the energy usage indicator moves to the horizontal position.

**EV zone**

The EV zone shows the motor output during EV drive mode (driving with the engine stopped).

The EV zone consists of two zones that (1) and (2) in the illustration.

The zone (1) shows the state that the EV drive mode can be maintained and the zone (2) shows the state that the engine starts in high possibility.

As the motor output increases, the movement range of the needle of the energy usage indicator increases.

In addition, the needle of the energy usage indicator indicates the horizontal position when the engine is stopped or there is no electric energy by the motor output or the regenerative brake.

**NOTE**

- Depending on the state of the vehicle (such as during heating of air conditioner), the engine may start even if the needle of the energy usage indicator is indicated before the zone 2 (zone that the engine starts in high possibility).
- Even when the EV priority mode is selected and the engine does not start, the needle of the energy usage indicator may indicate the zone 2 (zone that the engine starts in high possibility).
- While the EV priority mode is selected, even if the needle of the energy usage indicator enters the zone 2, the engine will not start unless over the specified point by pressing the accelerator pedal.
- Depending on the vehicle condition, the movement of the needle of the energy usage indicator may be different or fluctuated.
- Economical driving can be done by operating in a state that the swing of the needle is small within the zone 1.

**Charge zone**

Indicates the charging power generated by the regenerative braking.

The more the needle moves, the more electric energy is charged.

The needle of the energy usage indicator may not enter the charge zone when the main drive lithium-ion battery is close to full charge.

Also, if the needle of the energy usage indicator indicates the engine output zone, the needle will not indicate the charge zone even when the main drive lithium-ion battery is charged with regenerative braking.

**NOTE**

- You can check the charging power generated by regenerative braking with the charging power gauge in the multi-information display even while the engine is running.
- The charging power generated by regenerative braking is indicated by both the charge zone in the energy usage indicator and the charging power gauge in the multi-information display.

**Engine output zone**

Indicates the instantaneous engine output (kW).

**Meter illumination control**

N00554901365

Each time you press this button, there is a sound and the brightness of the instruments changes.

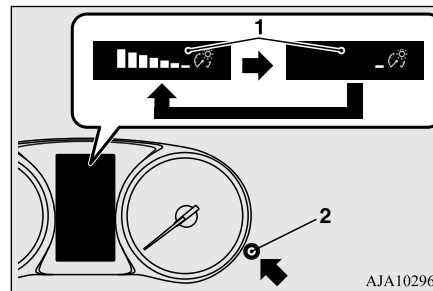

- 1- Brightness level
- 2- Rheostat illumination button

**NOTE**

- You can adjust to 8 different levels for when the front side-marker lights are illuminated and when they are not.
- The light switch is in a position other than the "OFF" position and it is sufficiently dark outside the vehicle, the meter illumination switches automatically to the adjusted brightness.
- The brightness level of the instruments is stored when the operation mode of the power switch is put in OFF.

**NOTE**

- If you press and hold the button for longer than approximately 2 second when the front side-marker lights are illuminated, the brightness level changes to the maximum level. Pressing and holding the button for longer than approximately 2 second again returns the brightness level to the previous level.

It is recommended to use this function when it is difficult to read the meter due to the meter illumination is dimmed by turning on the tail lights in bright areas.

For vehicles equipped with the Smartphone-link Display Audio (SDA), the operation of the screen background theme and the switch illumination when the meter illumination brightness level is changed to the maximum vary depending on the specifications of the SDA.

## Multi-information display

### Multi-information display

N00555001523

The multi-information display displays warnings, the odometer, trip odometer, average fuel consumption, EV cruising range, total cruising range, EVHV driving rate, energy flow, etc.

5

It is also possible to change elements such as the language and units used on the multi-information display.

[With operation mode of the power switch in OFF]

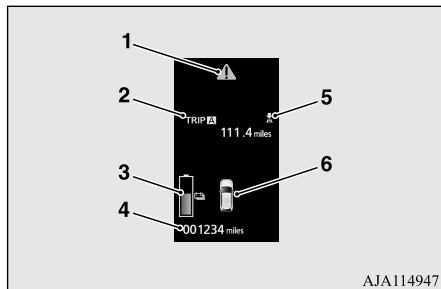

- 1- Warning display screen → P.5-147
- 2- Information screen → P.5-143  
Interrupt display screen → P.5-146
- 3- Main drive lithium-ion battery level display screen → P.5-147
- 4- Odometer → P.5-148

5-140 Features and controls

- 5- or mark indicator  
→ P.5-146
- 6- Door ajar warning display screen  
→ P.5-147

### NOTE

- The main drive lithium-ion battery level display screen appears when any of the doors or the liftgate is opened during charging.

## Multi-information display

[With operation mode of the power switch in ON]

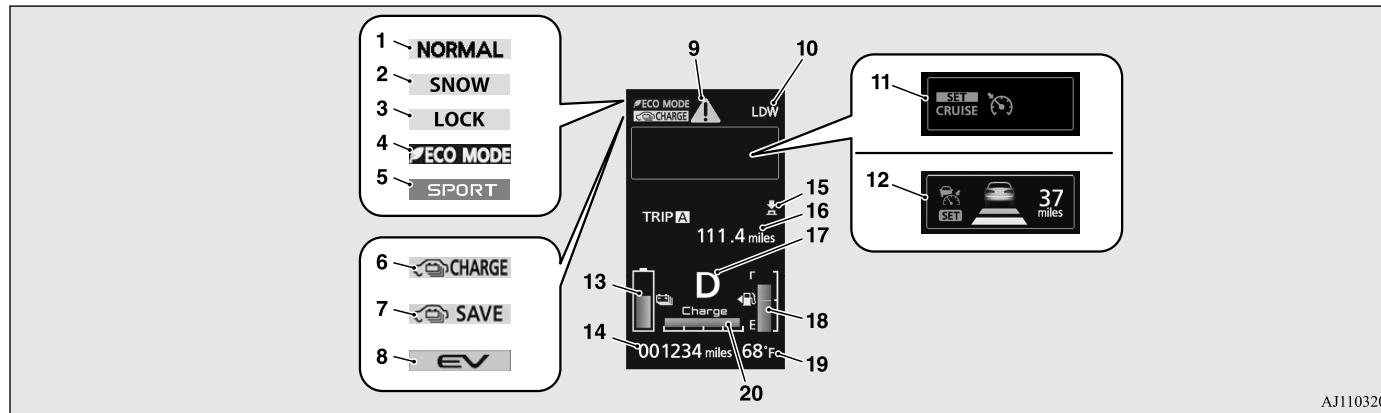

- 1- NORMAL mode indicator display screen → P.5-61
- 2- SNOW mode indicator display screen → P.5-61
- 3- LOCK mode indicator display screen → P.5-61
- 4- ECO mode indicator display → P.5-199
- 5- SPORT mode indicator display → P.5-71
- 6- Battery charge mode display screen → P.5-69
- 7- Battery save mode display screen → P.5-69
- 8- EV priority mode display screen → P.5-66

- 9- Warning display screen → P.5-147
- 10- Lane Departure Warning system (LDW) display screen (if so equipped) → P.5-118
- 11- Cruise control display screen (if so equipped) → P.5-84
- 12- Adaptive Cruise Control System (ACC) display screen (if so equipped) → P.5-88
- 13- Main drive lithium-ion battery level display screen → P.5-147
- 14- Odometer → P.5-148
- 15- or mark indicator → P.5-146
- 16- Information screen → P.5-144

- 17- Select position display → P.5-58
- 18- Fuel remaining display screen → P.5-147
- 19- Outside temperature display screen → P.5-148
- 20- Charging power gauge → P.5-148

**NOTE**

- The fuel units, outside temperature units, display language, and other settings can be changed. Refer to “Changing the function settings” on page 5-153.

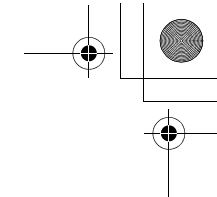

## Multi-information display

### Multi-information display switch

N00555101247

Each time the multi-information display switch is operated, the buzzer sounds and the multi-information display changes between information such as warnings, trip odometer, average fuel consumption, EV cruising range, total cruising range, EVHV driving rate, energy flow, etc.

**5**

It is also possible to change elements such as the language and units used on the multi-information display by operating the multi-information display switch.

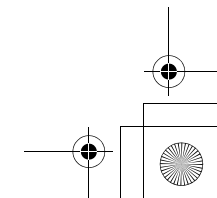
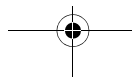
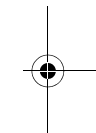
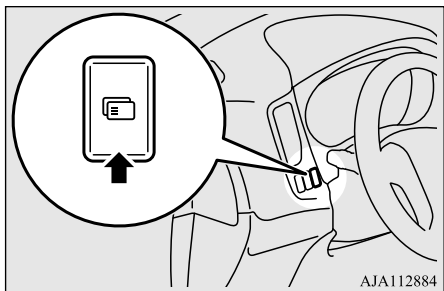
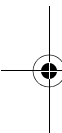

Multi-information display

**Information screen (With the operation mode in OFF)**

N00555301210

Each time you lightly press the multi-information display switch, the display screen switches in the following order.

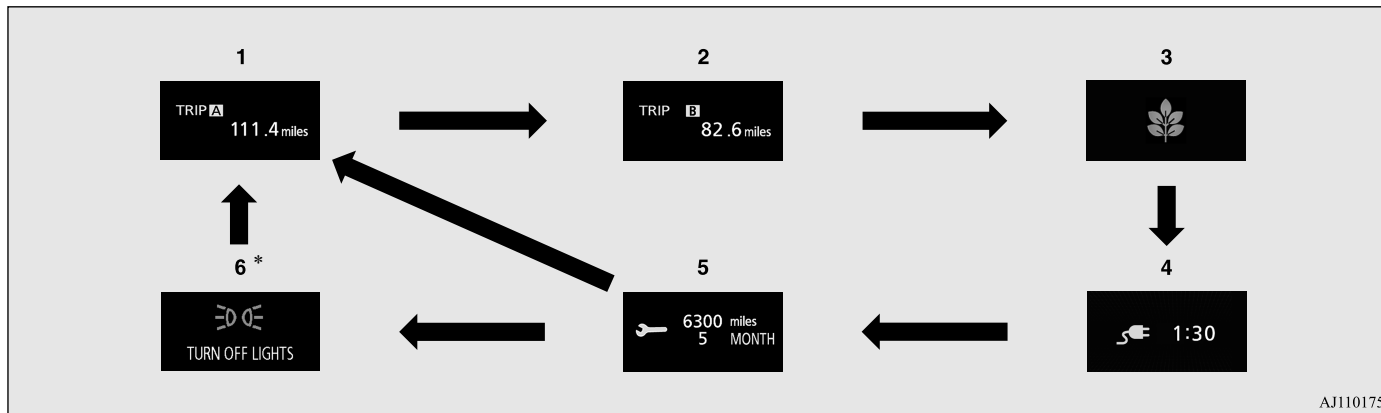

\*: When there is a warning display

- 1- Trip odometer **A** → P.5-149
- 2- Trip odometer **B** → P.5-149
- 3- ECO score display → P.5-153
- 4- Predicted charging time → P.3-22, 3-32
- 5- Service reminder → P.5-149
- 6- Redisplay of a warning display screen → P.5-146

## Multi-information display

### Information screen (With the operation mode is changed from OFF to ON)

N0055801332

When the operation mode is put in ON, the display screen switches in the following order.

5

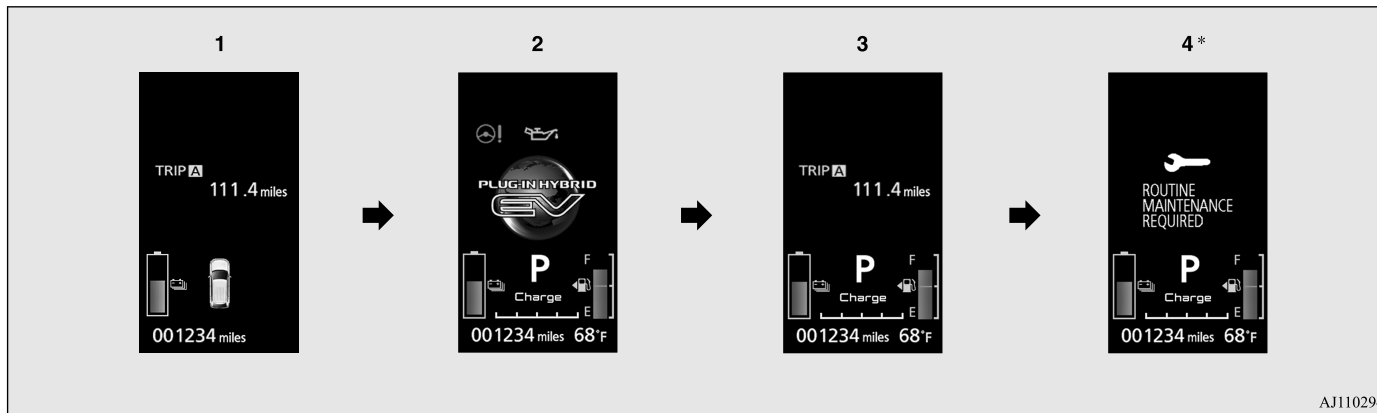

- \*: When the inspection time has arrived
- 1- Screen when the operation mode is OFF
  - 2- System check screen → P.5-150
  - 3- Screen when the operation mode is ON
  - 4- Service reminder → P.5-149



Multi-information display

**Information screen (With the operation mode in ON)**

N00556201333

Each time you lightly press the multi-information display switch, the display screen switches in the following order.

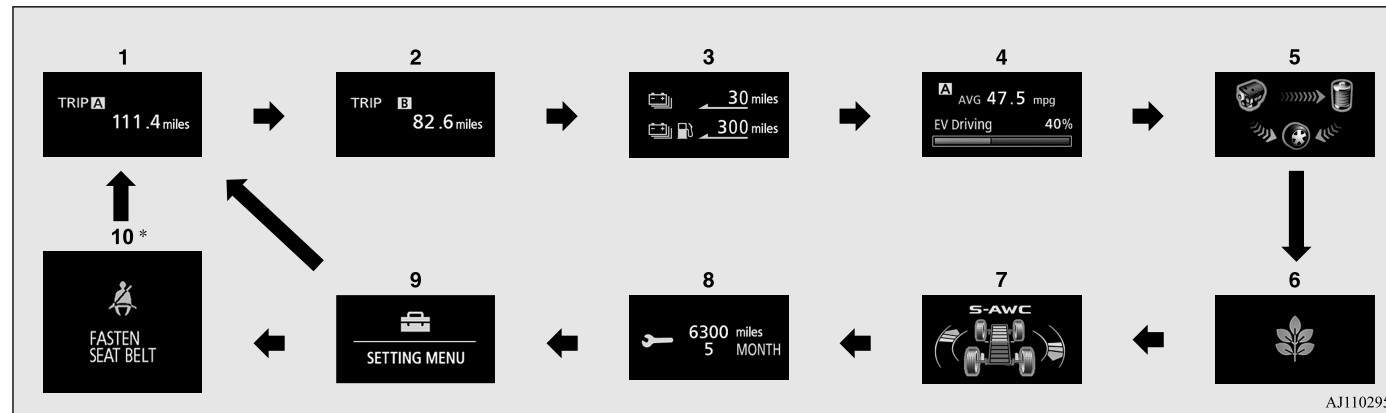

\*: When there is a warning display

- 1- Trip odometer **A** → P.5-149
- 2- Trip odometer **B** → P.5-149
- 3- EV cruising range display/Total cruising range display → P.5-151
- 4- Average fuel consumption display → P.5-151  
EVHVV driving rate display → P.5-152
- 5- Energy flow display → P.5-152
- 6- ECO score display → P.5-153
- 7- S-AWC operation display → P.5-63
- 8- Service reminder → P.5-149
- 9- Function setting screen → P.5-153
- 10- Redisplay of a warning display screen → P.5-146

## Multi-information display

### NOTE

- While driving, the service reminder are not displayed even if you operate the multi-information display switch. Always stop the vehicle in a safe place before operating.
- While driving, the function setting screen is not displayed even if you operate the multi-information display switch. Always park the vehicle in a safe place, firmly apply the parking brake and press the electrical parking switch before operating the function setting screen. Refer to “Changing the function settings” on page 5-153.
- When there is information to be announced, such as a system fault, the tone sounds and the screen display is switched. Refer to “Interrupt display screen” on page 5-146.

5

### Interrupt display screen

N00556301291

### Warning display

When there is information to be announced, such as a system fault, the tone sounds and the information screen is switched to the warning display screen.

Refer to the warning list and take the necessary measures.

Refer to “Warning display list” on page 5-162.

When the cause of the warning display is eliminated, the warning display goes out automatically.

#### Returning to the display screen from before the warning display

Even if the cause of the warning display is not eliminated, you can return to the screen

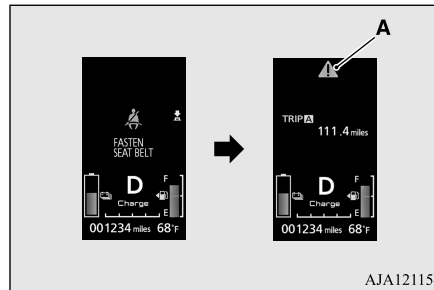

that was displayed before the warning display.

If you press the multi-information display switch, the display screen switches to the screen display from before the warning and the  warning (A) is displayed.



AJA121154

#### If you want to switch the display

Warning display screens with a  or  mark displayed in the upper right of the

screen can be switched. If you want to switch the display, press the multi-information display switch as follows.

: Press lightly.

: Press for approximately 2 seconds or more.

### Redisplay of a warning display screen

N0057960047

When the  warning is displayed, if you lightly press the multi-information display switch a few times, the warning display screen you switched from is redisplayed.

### Other interrupt displays

N0057970022

The operation status of each system is displayed on the information screen.

For further details, refer to the appropriate page in the warning display list.

## Multi-information display

Refer to “Other interrupt displays” on page 5-181.

### Warning display screen

N00555201251

This is displayed when you press the multi-information display switch and return from the warning display screen to the previous screen.

This mark is also displayed if there is another warning other than the one displayed.

When the cause of the warning display is eliminated, the  warning goes out automatically.

#### NOTE

- When the  warning is displayed, the warning display screen can be redisplayed on the information screen.

Refer to “Information screen (with the operation mode in OFF)” on page 5-143.

Refer to “Information screen (with the operation mode in ON)” on page 5-145.

### Door ajar warning display screen

N00529700027



If any of the doors or the liftgate is not completely closed, this displays the open door or liftgate.

If the speed increases to approximately 5 mph (8 km/h) or higher with a door ajar, a tone will sound 4 times to inform you that a door is ajar.

#### CAUTION

- Always make sure that the warning display goes out before beginning to drive.

### Main drive lithium-ion battery level display screen

N00588300024

Indicates the remaining power in the main drive lithium-ion battery.

### Fuel remaining display screen

N00556601207

Shows the amount of fuel remaining.

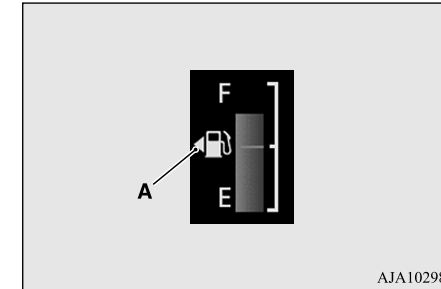

AJA102982

F- Full  
E- Empty

5

#### NOTE

- It may take several seconds to stabilize the display after refilling the tank.
- If fuel is added with the operation mode in ON, the remaining fuel display may incorrectly indicate the fuel level.
- The arrow (A) indicates that the fuel tank filler door is located on the left side of the vehicle. (Refer to “Filling the fuel tank” on page 3-51.)

## Multi-information display

### Fuel remaining warning display

N00578300092

When the fuel level runs low, the information screen switches to the interrupt display of the fuel remaining warning display and the mark (B) on the fuel remaining display flashes. If the warning display appears, refuel as soon as possible.

5

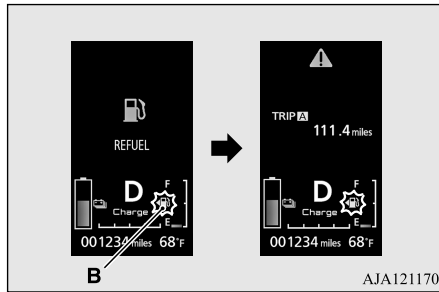

### CAUTION

- If the vehicle is runs out of fuel, the engine will not start even in a situation need to be generated electricity, the following conditions will occur.
- The driving performance falls (since only the electrical power stored in the main drive lithium-ion battery can be used for the driving).
- The effectiveness of the heater is insufficient.

### CAUTION

- The catalytic converter may be damaged due to excessive high temperature.

### NOTE

- On hills or curves, the display may be incorrect due to the movement of fuel in the tank.
- Battery save mode or battery charge mode canceled or may not be activated even if the battery save mode switch or the battery charge mode switch is pressed, depending on the remaining quantity of the main drive lithium-ion battery or the control condition of the system.

### Charging power gauge

N00597700037

Shows instantaneous charging power generated by the regenerative braking.

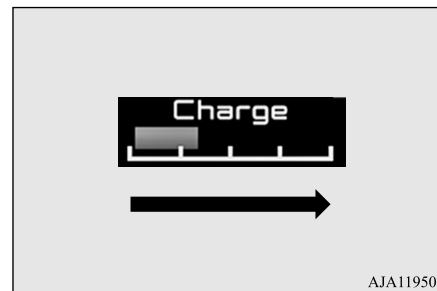

### NOTE

- The charging power gauge does not include the electricity generated by the engine.
- The charging power gauge does not indicate the vehicle driving condition in the battery charge mode.
- The movement of the gauge decreases as the main drive lithium-ion battery level is nearly full.

### Outside temperature display screen

N00556501118

Shows the temperature outside the vehicle.

### NOTE

- The display setting can be changed to the preferred units (°F or °C). Refer to “Changing the function settings” on page 5-153.
- Depending on factors such as the driving conditions, the displayed temperature may vary from the actual outside temperature.

### Odometer

N00574901026

Shows the total distance traveled.

## Trip odometer

N00575001066

Shows the distance traveled between two points.

Usage examples for trip odometer **A**, trip odometer **B**

It is possible to measure two currently traveled distances, from home using trip odometer **A** and from a particular point on the way using trip odometer **B**.

## To reset the trip odometer

To return the display to 0, hold down the multi-information display switch for approximately 2 seconds or more. Only the currently displayed value will be reset.

Example

If trip odometer **A** is displayed, only trip odometer **A** will be reset.

- Both trip odometers **A** and **B** can count up to 9999.9 miles/kilometers. When a trip odometer goes past 9999.9 miles/kilometers, it returns to 0.0 miles/kilometers.

- When disconnecting the 12 V starter battery terminal, the memories of trip odometer displays **A** and **B** are cleared, and their displays return to “0.0 miles/kilometers”.

## Service reminder

N00556701341

Displays the approximate time until the next recommended periodic inspection. “---” is displayed when the inspection time has arrived.

### NOTE

- The service reminder time can be modified by a certified Mitsubishi EV dealer, to adjust for severe usage, etc. Refer to “Severe maintenance schedule” in your vehicle’s Warranty and Maintenance Manual. For further information, please contact a certified Mitsubishi EV dealer.

## Multi-information display

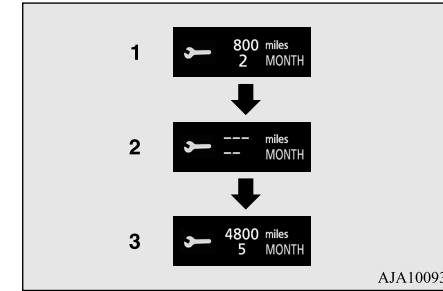

1. Shows the time until the next periodic inspection.

### NOTE

- Shows the distance in units of 100 miles (100 km) and the time in units of 1 month.

2. This informs you that a periodic inspection is due. Contact a certified Mitsubishi EV dealer to have the system checked.

At that time, when the operation mode is changed from OFF to ON, the warning display is displayed for a few seconds on the information screen.



## Multi-information display

3. After your vehicle is inspected at a certified Mitsubishi EV dealer, it displays the time until the next periodic inspection.

### To reset

**5**

The “---” display can be reset while the operation mode of the power switch is in OFF. When the display is reset, the time until the next periodic inspection is displayed and the warning display is no longer displayed when the operation mode is changed from OFF to ON.

1. When you lightly press the multi-information display switch, the information screen switches to the service reminder display screen.

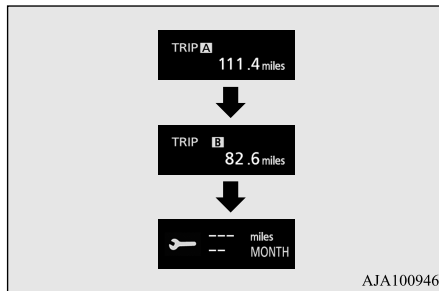

2. Press and hold the multi-information display switch (for approximately 2 seconds or more) to display “” and make it flash. (If there is no operation for approximately 10 seconds with this indicator flashing, the display returns to the previous screen.)

3. With this indicator flashing, if you lightly press the multi-information display switch, the screen switches from “---” to “CLEAR”. After that, the time until the next periodic inspection is shown.

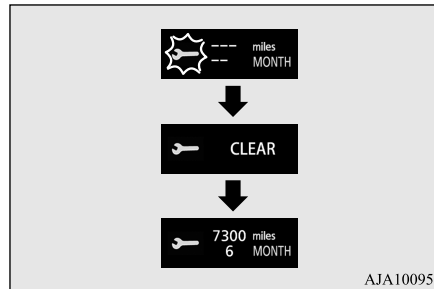

### CAUTION

- The customer is responsible for making sure that regular inspections and maintenance and periodic inspections and maintenance are performed. Inspections and maintenance must be performed to prevent accidents and malfunctions.

### NOTE

- The “---” display cannot be reset while the operation mode is in ON.
- When “---” is displayed, after a certain distance and a certain period of time, the display is reset and the time until the next periodic inspection is displayed.
- If you accidentally reset the display, consult a certified Mitsubishi EV dealer for assistance.

## System check screen

N0057840035

When the operation mode is put in ON, the system check screen is displayed for approximately 4 seconds. If there is no fault, the information screen is displayed.

If there is a fault, the screen changes to warning display.

Refer to “Warning display list” on page 5-162.



### NOTE

- The system check screen display varies depending on your equipment.

## Multi-information display

**EV cruising range display/Total cruising range display**

N00588400054

This displays the approximate driving range (how many more miles or kilometers you can drive).

**EV cruising range display (A)**

This displays the distance that can be traveled with the remaining power in the main drive lithium-ion battery.

**Total cruising range display (B)**

This displays the distance that can be traveled with the remaining power in the main drive lithium-ion battery and the remaining amount of fuel.

**NOTE**

- The EV cruising range may vary depending on driving conditions and your personal driving habits. The EV cruising range is calculated from the following information.
  - Current remaining power in the main drive lithium-ion battery.

**NOTE**

- The Most recent electric power consumption rate.
  - Operation status of the air-conditioner.
- If the preceding driving condition is in the following situations, the EV cruising range display may show less distance than before even though there are almost the same level remaining power in the main drive lithium-ion battery.
- When much electricity is consumed from the main drive lithium-ion battery, such as in a traffic jam, hill-climbing or high-speed driving.
  - When the air conditioner is operating.

Treat the distance displayed as just a rough guideline.

In addition, disconnecting the 12 V starter battery cable will reset the EV cruising range and the EV cruising range display may show the different distance from the previous distance.

- The learned value for the EV cruising range can be reset by operating the multi-information display switch. If the EV cruising range display shows extremely different distance, please reset the learned value to the initialized value. For details, refer to "Reset of EV/Total cruising range" on page 5-158.

**NOTE**

- When the main drive lithium-ion battery is charged or the vehicle is refueled, the cruising range display is updated. However, if the charge level is low or the refueling amount is small, it cannot be updated correctly. Fully charge the main drive lithium-ion battery or refill to full tank whenever possible.
- On rare occasions, the value displayed for the driving range may change if you are parked on an extremely steep incline. This is due to the movement of fuel in the tank and does not indicate any malfunction.
- The display setting can be changed to the preferred units (miles or km). Refer to "Changing the function settings" on page 5-153.
- When the EV cruising range falls below approximately 1 mile (1 km), the EV cruising range display shows "---".
- When the total cruising range falls below approximately 30 miles (50 km), the total cruising range display shows "---".
- When the EV cruising range and total cruising range cannot be accurately measured because there is some fault in the vehicle, these display shows "---".

5

**Average fuel consumption display**

N00575301043

This displays the average fuel consumption from the last reset to the present.

Features and controls 5-151

## Multi-information display

There are 2 types of mode settings of manual reset and automatic reset.

Refer to “Changing the reset mode for average fuel consumption” on page 5-154.

For information on how to change the average fuel consumption display setting, refer to “Changing the function settings” on page 5-153.

5

### NOTE

- The average fuel consumption display can be reset separately in both auto reset mode and manual reset mode.
- “---” is displayed when the average fuel consumption cannot be measured.
- The initial (default) setting is “Auto reset mode”.
- Average fuel consumption may vary depending on the driving conditions (road conditions, how you drive, etc.) The actual fuel consumption may differ from the fuel consumption displayed, so treat the fuel consumption displayed as just a rough guideline.
- Disconnecting the 12 V starter battery cable will erase from memory the manual reset mode or auto reset mode setting for the average fuel consumption display.
- The display setting can be changed to the preferred units {mpg (US), mpg (UK), L/100km or km/L}.  
Refer to “Changing the function settings” on page 5-153.

## EVHV driving rate display

N00588500026

This displays the ratios of the time traveled with electric power and the time traveled with both electric power and engine power.

The ratio of the time traveled with electric power is displayed with a bar graph (blue) and in a percentage.

### NOTE

- When the main drive lithium-ion battery is fully charged, EVHV driving rate is reset and display becomes 100 %.

## Energy flow display

N00588600043

This displays the flow of energy.

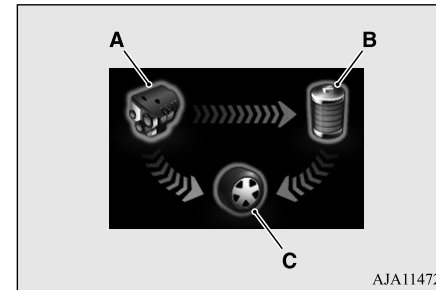

- A- Engine
- B- Main drive lithium-ion battery
- C- Tire

Blue arrow- Flow of electric energy  
Amber arrow- Flow of other energy



## Display of energy flow (example)

### ■ When driving with electric energy



### ■ When driving with fuel (gasoline) energy



### ■ When driving with both electric energy and fuel (gasoline) energy



### ■ When charging the main drive lithium-ion battery



### ■ When there is no energy flow



### NOTE

- During charging, the energy flow display for charging is displayed. For details, refer to “Energy flow display during charging” on page 3-44.

## ECO Score

N00578800068

ECO score indicates the points you have scored on fuel-efficient driving by the number of leaves as follows:

[When the operation mode is ON]

## Multi-information display

The display shows the score you achieved in the last several minutes.

[When the operation mode is put in OFF]

The display shows the overall ECO score the function has counted from the time when the operation mode is set to “ON” to the time when it is set to “OFF”.

5

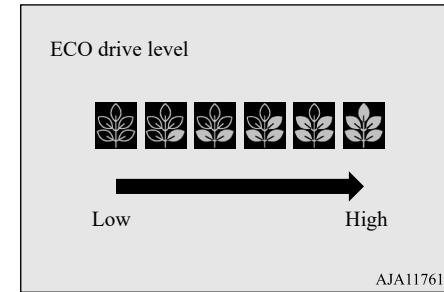

## Changing the function settings

N00556801342

1. Park your vehicle in a safe place.  
Firmly apply the parking brake and press the electrical parking switch and shift to the “P” (PARK) position.
2. When you lightly press the multi-information meter switch, the information screen switches to the function setting screen. Refer to “Information screen” on page 5-145.

Features and controls 5-153

## Multi-information display



**5**

### CAUTION

- For safety, stop the vehicle before operating. While driving, even if you operate the multi-information display switch, the function setting screen is not displayed.

- Press and hold the multi-information display switch (for approximately 2 seconds or more) to switch from the setting mode screen to the menu screen.

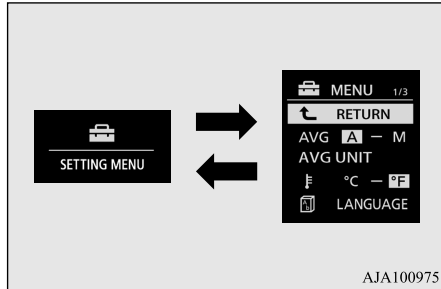

### NOTE

- To return the menu screen to the function setting screen, press and hold the multi-information display switch (for approximately 2 seconds or more).

### NOTE

- If no operations are made within approximately 30 seconds of the menu screen being displayed, the display returns to the function setting screen.

- Select the item to change on the menu screen and change to the desired setting. For further details on the operation methods, refer to the following sections.

Refer to “Changing the reset mode for average fuel consumption” on page 5-154. Refer to “Changing the fuel consumption display unit” on page 5-155.

Refer to “Changing the temperature unit” on page 5-156.

Refer to “Changing the display language” on page 5-156.

Refer to “Changing the language on other system to match the multi-information display” on page 5-157.

Refer to “Operation sound setting” on page 5-157.

Refer to “Changing the time until “REST REMINDER” is displayed” on page 5-158.

Refer to “Changing the turn signal sound” on page 5-158.

Refer to “Tire ID set change” on page 5-125.

Refer to “Reset of EV/Total cruising range” on page 5-158.

Refer to “Returning to the factory settings” on page 5-159.

### NOTE

- If the 12 V starter battery is disconnected, these function settings are reset from memory and is automatically to the factory settings (except the tire ID set).
- You cannot select an item that is displayed dimly on the menu.

## Changing the reset mode for average fuel consumption

N00557001279

You can change the mode condition for the average fuel consumption to “Auto reset” or “Manual reset.”

- Press and hold the multi-information display switch (for approximately 2 seconds or more) to switch from the setting mode screen to the menu screen.

Refer to “Changing the function settings” on page 5-153.

- Lightly press the multi-information display switch to select “AVG” (average fuel consumption setting).

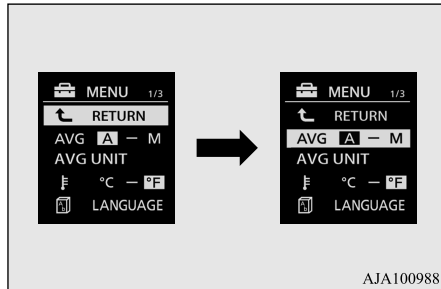

- Press and hold the multi-information display switch (for approximately 2 seconds or more) to switch in sequence from A or 1 (Auto reset) → M, 2 or P (Manual reset) → A or 1 (Auto reset). The setting is changed to the selected reset condition.

#### Manual reset mode

- If you press and hold the multi-information meter switch when the average fuel consumption is displayed, these calculations will be reset to zero.
- When the operation mode is changed from ACC or OFF to ON, the mode setting changes automatically from manual to auto.

#### Auto reset mode

- When the average fuel consumption is being displayed, if you hold down the multi-information display switch, these calculations will be reset to zero.
- When the operation mode has been in ACC or OFF for approximately 4 hours or more, the average fuel consumption display will automatically reset.

#### NOTE

- The average fuel consumption display can be reset separately in both auto reset mode and manual reset mode.
- Disconnecting the 12 V starter battery cable will erase from memory the manual reset mode or auto reset mode setting for the average fuel consumption display.
- The initial (default) setting is “Auto reset mode”.

#### Changing the fuel consumption display unit

N00557101209

The fuel consumption display unit can be changed. The distance and amount units are also changed to match the selected fuel consumption unit.

#### Multi-information display

- Press and hold the multi-information display switch (for approximately 2 seconds or more) to change from the setting mode screen to the menu screen. Refer to “Changing the function settings” on page 5-153.
- Lightly press the multi-information display switch to select “AVG UNIT” (fuel consumption display unit setting).

5

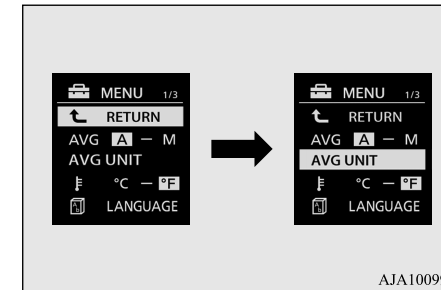

- Press and hold the multi-information display switch (for approximately 2 seconds or more) to display “AVG UNIT” (fuel consumption display unit setting).
- Lightly press the multi-information display switch to switch to select the units.
- Press and hold the multi-information display switch (for approximately 2 seconds or more) to change the setting to the selected unit.

## Multi-information display

5

### NOTE

- The display units for the average fuel consumption and the driving range are changed, but the units for the indicating needle (speedometer), the odometer and the trip odometer will remain unchanged.
- If the 12 V starter battery is disconnected, the memory of the unit setting is erased and is automatically set to {mpg (US) or L/100 km}.

The distance and speed units are also changed in the following combinations to match the selected fuel consumption unit.

Fuel economy	Distance (driving range)
mpg (US)	mile (s)
mpg (UK)	mile (s)
km /L	km
L /100 km	km

## Changing the temperature unit

N00557201271

The temperature display unit can be switched.

1. Press and hold the multi-information display switch (for approximately 2 seconds or more) to switch from the setting mode screen to the menu screen.

5-156 Features and controls

Refer to “Changing the function settings” on page 5-153.

2. Lightly press the multi-information display switch to select “**F**” (temperature unit setting).
3. Press and hold the multi-information display switch (for approximately 2 seconds or more) to switch in from °F to °C, or from °C to °F.

The setting is changed to the selected temperature unit.

### NOTE

- The temperature value on air conditioner panel is switched in conjunction with outside temperature display unit of the multi-information display. However, “°F” or “°C” are not shown to temperature display of an air conditioner.
- On vehicles equipped with the Smartphone-link Display Audio (SDA), the temperature value shown on the air conditioner screen of SDA is switched in conjunction with outside temperature display unit of the multi-information display.
- If the 12 V starter battery is disconnected, the memory of the unit setting is erased and is automatically set to °F (°C).

## Changing the display language

N00557301214

The language of the multi-information display can be changed.

1. Press and hold the multi-information display switch (for approximately 2 seconds or more) to change from the setting mode screen to the menu screen. Refer to “Changing the function settings” on page 5-153.
2. Lightly press the multi-information display switch to select “LANGUAGE” (language setting).

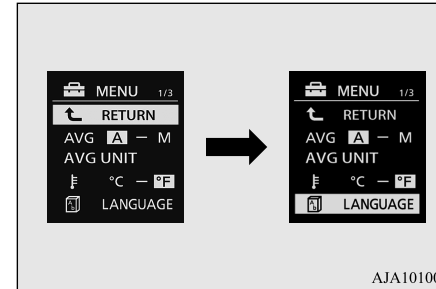

AJA101002

3. Press and hold the multi-information display switch (for approximately 2 seconds or more) to display “LANGUAGE” (language setting).
4. Lightly press the multi-information display switch to select the desired language.

## Multi-information display

- Press and hold the multi-information display switch (for approximately 2 seconds or more) to change the setting to the selected language.

### NOTE

- If the 12 V starter battery is disconnected, the memory of the language setting is erased and is automatically set to ENGLISH.
- If “---” is selected in the language setting, a warning message is not displayed when there is a warning display or interrupt display.

### Changing the language on other system to match the multi-information display

N00529801357

The language used in Multi Around Monitor (if so equipped) can be changed automatically to the same language as that shown in the multi-information display.

- Press and hold the multi-information display switch (for approximately 2 seconds or more) to switch from the setting mode screen to the menu screen. Refer to “Changing the function settings” on page 5-153.

- Lightly press the multi-information display switch to select “” (language cooperative control).

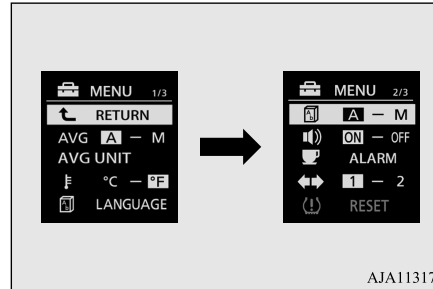

AJA113171

- Press and hold the multi-information display switch to switch from A/1 (language cooperation: enabled) to M/2/P (language cooperation: disabled), or from M/2/P to A/1. The setting is changed to the selected condition.

### NOTE

- If the 12 V starter battery is disconnected, the language cooperative control is automatically set to “A or 1” (language cooperation: enabled).
- The language cooperation setting can be switched in the following manner.

### NOTE

- When “A or 1” (language cooperation: enabled) has been selected, the language for Multi Around Monitor (if so equipped) is automatically changed to the language selected for the multi-information display. However, this changing function may not work depending on the language selected for the multi-information display.
- When “M, 2 or P” (language cooperation: disabled) has been selected, the language for Multi Around Monitor (if so equipped) is not automatically changed to match the language selected for the multi-information display.
- The language on the audio system’s display does not automatically change when you select A or 1 (language cooperation: enabled) in the language cooperation control.

5

### Operation sound setting

N00557401185

You can turn off the operation sounds of the multi-information display switch and rheostat illumination button.

- Press and hold the multi-information display switch (for approximately 2 seconds or more) to switch from the setting mode screen to the menu screen. Refer to “Changing the function settings” on page 5-153.

## Multi-information display

5

2. Lightly press the multi-information display switch to select “” (operation sound setting).
3. Press and hold the multi-information display switch (for approximately 2 seconds or more) to switch from ON (operation sound on) to OFF (operation sound off), or from OFF to ON.

The setting is changed to the selected condition.

### NOTE

- If the 12 V starter battery is disconnected, the memory of the operation sound setting is erased and is automatically set to “ON” (operation sound on).
- The operation sound setting only deactivates the operation sound of the multi-information display switch and rheostat illumination button. The warning display and other sounds cannot be deactivated.

## Changing the time until “REST REMINDER” is displayed

N00557501199

The time until the display appears can be changed.

1. Press and hold the multi-information display switch (for approximately 2 seconds or more) to switch from the setting mode screen to the menu screen.  
Refer to “Changing the function settings” on page 5-153.
2. Lightly press the multi-information display switch to select “ALARM” (rest time setting).
3. Press and hold the multi-information display switch (for approximately 2 seconds or more) to display “ALARM” (rest time setting).
4. Lightly press the multi-information display switch to select the time until the display appears.
5. Press and hold the multi-information display switch (for approximately 2 seconds or more) to change the setting to the selected time.

### NOTE

- If the 12 V starter battery is disconnected, the memory of the unit setting is erased and is automatically set to the “OFF”.
- The drive time is reset when the operation mode is in OFF.

## Changing the turn signal sound

N00563501110

It is possible to change the turn signal sound.

1. Press and hold the multi-information display switch (for approximately 2 seconds or more) to switch from the setting mode screen to the menu screen.  
Refer to “Changing the function settings” on page 5-153.
2. Lightly press the multi-information display switch to select  (changing the turn signal sound)
3. Press and hold the multi-information display switch (for approximately 2 seconds or more) to switch from 1 (turn-signal sound 1) to 2 (turn-signal sound 2), or from 2 to 1.  
The setting changes to the selected turn signal sound.

## Reset of EV/Total cruising range

N00597800038

The learned value for EV cruising range reset to the initialized value.

1. Press and hold the multi-information display switch for approximately 2 seconds or more to switch from the setting mode screen to the menu screen.  
Refer to “Changing the function settings” on page 5-153.

2. Lightly press the multi-information display switch to select “ RESET” (Reset of EV cruising range).
3. When you press and hold the multi-information display switch for approximately 3 seconds or more, the buzzer sounds and the learned value reset to the default values.

### Returning to the factory settings

N00557601288

Many of the function settings can be returned to their factory settings.

1. Press and hold the multi-information display switch (for approximately 2 seconds or more) to switch from the setting mode screen to the menu screen.  
Refer to “Changing the function settings” on page 5-153.
2. Lightly press the multi-information display switch to select “ RESET” (return to the factory settings).
3. Press and hold the multi-information display switch (for approximately 5 seconds or more), the buzzer sounds and all of the function settings are returned to the factory settings.

### NOTE

- The factory settings are as follows.
  - Average fuel consumption reset mode: A (Auto reset)
  - Fuel consumption display unit: mpg (US) or (L/100 km)
  - Temperature unit: °F (Fahrenheit) or {°C (Celsius)}
  - Display language: ENGLISH
  - Cooperative language setting: A (language cooperation: enabled)
  - Operation sounds: ON (Operation sound on)
  - “REST REMINDER” display: OFF
  - Turn signal sound: Turn signal sound 1
- The tire ID set cannot be returned to the factory settings.
- The learned value for EV cruising range does not return to the initialized value.

Indicator light, warning light, and information screen display list

**Indicator light, warning light, and information screen display list**

N00557701061

**Indicator and warning light list**

N00557801437

**5**

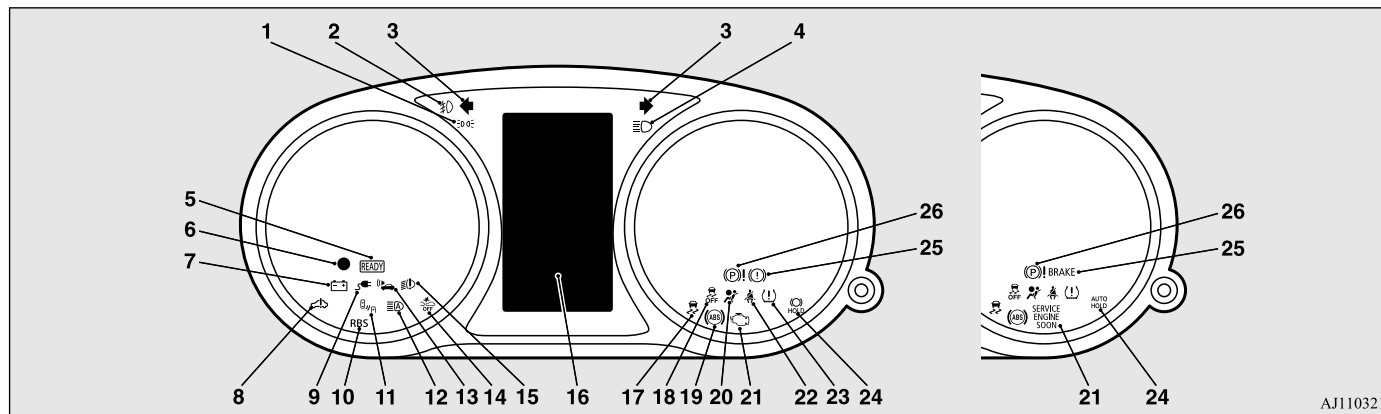

AJ1103219

- |   |   |  |
|---|---|--|
| 1- Position indicator → P.5-186                                 | 9- Charging indicator → P.5-187   | 14- Forward Collision Mitigation System (FCM) OFF indicator (if so equipped) → P.5-104 |
| 2- Front fog light indicator → P.5-186                          | 10- Regenerative brake warning light → P.5-189                          | 15- LED headlight warning light (if so equipped) → P.5-192                             |
| 3- Turn signal indicators/Hazard warning lights → P.5-186       | 11- Blind Spot Warning (BSW) indicator light (if so equipped) → P.5-110 | 16- Information screen display list → P.5-161  |
| 4- High beam indicator → P.5-186                                | 12- Automatic High Beam (AHB) indicator (if so equipped) → P.5-193      | 17- Active stability control (ASC) indicator → P.5-83                                  |
| 5- Ready indicator → P.5-187                                    | 13- Acoustic Vehicle Alerting System (AVAS) indicator → P.5-72          | 18- Active stability control (ASC) OFF indicator → P.5-83                              |
| 6- Theft-alarm indicator → P.5-37                               |   |  |
| 7- 12 V starter battery charging system warning light → P.5-188 |   |  |
| 8- Plug-in Hybrid EV System warning light → P.5-189             |   |  |

5-160 Features and controls



## Indicator light, warning light, and information screen display list

- 19- Anti-lock braking system (ABS) warning light → P.5-79
- 20- Supplemental Restraint System (SRS) warning light → P. 4-42
- 21- Engine malfunction indicator (“SERVICE ENGINE SOON” or “Check engine light”) → P.5-188
- 22- Driver’s seat belt warning light → P.4-20
- 23- Tire pressure monitoring system (TPMS) warning light → P.5-122
- 24- Brake auto hold indicator → P.5-74
- 25- Brake warning light → P.5-187
- 26- Electric parking brake warning light → P.5-188

5

## Information screen display list

N00557901135

When there is information to be announced, such as light reminder, the tone sounds and the screen switches to the displays shown below. Refer to the appropriate page and take the necessary measures.

When the cause of the warning display is eliminated, the warning display goes out automatically.

Refer to “Warning display list” on page 5-162.

Refer to “Other interrupt displays” on page 5-181.

### NOTE





- In the following cases, a warning may be displayed on the information screen and the buzzer may sound for a few seconds, at times. This is caused by the system picking up interference such as strong electromagnetic waves or noise, and is not a functional problem.
    - An extremely strong electromagnetic wave is received from a source such as an illegal radio set, a spark from a wire, or a radar station.
    - Abnormal voltage or a static electricity discharge is generated by the operation of your vehicle’s electronics (including after-market parts).
- If the warning display has occurred a number of times, take your vehicle to a certified Mitsubishi EV dealer and have the system checked.

## Indicator light, warning light, and information screen display list



## Warning display list

N00558001436

5

Screen	Cause	Do this (Reference)
 <p>EV SYSTEM SERVICE REQUIRED</p>	<ul style="list-style-type: none"> <li>One or more failure is occurring in the Plug-in Hybrid EV System.</li> </ul>	<ul style="list-style-type: none"> <li>Have your vehicle inspected by a certified Mitsubishi EV dealer.</li> </ul>
 <p>EV SYSTEM SERVICE REQUIRED STOP SAFELY</p>	<ul style="list-style-type: none"> <li>One or more failure is occurring in the Plug-in Hybrid EV System.</li> </ul>	<ul style="list-style-type: none"> <li>Park your vehicle in a safe place as soon as possible and contact a certified Mitsubishi EV dealer to have the system checked.</li> </ul>
 <p>P LOCK MALFUNCTION WHEN PARKING, APPLY PARKING BRAKE SECURELY</p>	<ul style="list-style-type: none"> <li>The parking lock unit is in failure. The Plug-in Hybrid EV System cannot be kept in standstill condition without applying the parking brake.</li> </ul>	<ul style="list-style-type: none"> <li>Park the vehicle at a safe, flat place and apply the parking brake. Contact a certified Mitsubishi EV dealer to have the system checked. Refer to “Electrical parking switch” on page 5-55.</li> </ul>
 <p>CHARGE CABLE CONNECTED</p>	<ul style="list-style-type: none"> <li>You are attempting to start the Plug-in Hybrid EV System when the charge connector is connected to the charge port.</li> </ul>	<ul style="list-style-type: none"> <li>Disconnect the charge connector from the charge port before operating the power switch.</li> </ul>
 <p>CHARGE INTERRUPTED BY SYSTEM MALFUNCTION</p>	<ul style="list-style-type: none"> <li>Charging was interrupted due to system failure or EV charging cable failure.</li> </ul>	<ul style="list-style-type: none"> <li>There is the system failure or the EV charging cable is faulty. Immediately stop using the cable and contact a certified Mitsubishi EV dealer to have the system checked.</li> </ul>



Indicator light, warning light, and information screen display list

Screen	Cause	Do this (Reference)
 <p>CHARGE STOPPED</p>	<ul style="list-style-type: none"> <li>● Normal charging                             <ul style="list-style-type: none"> <li>• Charging was interrupted due to poor connection of the EV charging cable or power failure.</li> </ul> </li> <li>● Quick charging                             <ul style="list-style-type: none"> <li>• Charging was stopped by your operation.</li> <li>• Charging was interrupted after the predetermined set time.</li> <li>• Charging was interrupted due to a poor connection of the EV charging cable or a electrical power failure.</li> <li>• Charging was interrupted because there is a problem in the vehicle or the quick charger.</li> </ul> </li> </ul>	<ul style="list-style-type: none"> <li>● Normal charging                             <ul style="list-style-type: none"> <li>• Connect the EV charging cable correctly. Refer to “Normal charging” on page 3-20.</li> <li>• If charging is interrupted due to a power failure, charging will resume automatically when the power source is reset.</li> </ul> </li> <li>● Quick charging                             <ul style="list-style-type: none"> <li>• Connect the EV charging cable correctly. Refer to “Quick charging” on page 3-32.</li> <li>• If charging is interrupted due to a power failure, start charging procedure again from the beginning after the power source is reset.</li> <li>• If the warning display appear in the meter of the vehicle or on the quick charger display, follow the instructions and take the necessary measures.</li> </ul> </li> </ul>
 <p>BATTERY TOO COLD</p>	<ul style="list-style-type: none"> <li>● The main drive lithium-ion battery temperature is too cold.</li> <li>● The battery charge mode switch is pressed when the main drive lithium-ion battery temperature is cold.</li> </ul>	<ul style="list-style-type: none"> <li>● In the daytime, wait for the temperature to rise. When the temperature in the vicinity of the main drive lithium-ion battery has risen, start up. (Except for vehicles equipped with main drive lithium-ion battery warming system)</li> <li>● Keep driving if you can drive at the same speed as surrounding vehicles. If you cannot drive the same speed as surrounding vehicles, stop the vehicle in a safe place. (Vehicles equipped with main drive lithium-ion battery warming system)</li> <li>● You do not have to take any actions, but the time needed to charge the main drive lithium-ion battery will become longer.</li> </ul>



5

Indicator light, warning light, and information screen display list

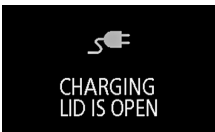
5

Screen	Cause	Do this (Reference)
	<ul style="list-style-type: none"> <li>The main drive lithium-ion battery is extremely cold temperature. The Plug-in Hybrid EV System will not start until the main drive lithium-ion battery is warm enough.</li> </ul>	<ul style="list-style-type: none"> <li>Even if the main drive lithium-ion battery is full charge, connect EV charging cable (normal charger). Then, the main drive lithium-ion battery warming system is operated, the main drive lithium-ion battery is automatically warmed up. While the main drive lithium-ion battery warning system is operating, "BATTERY TOO COLD" will be displayed. (Vehicles equipped with main drive lithium-ion battery warming system)</li> <li>Refer to "Charging from rated AC 120 V outlet" on page 3-22.</li> <li>Refer to "Cautions and actions to deal with intense cold" on page 3-13.</li> </ul>
	<ul style="list-style-type: none"> <li>The main drive lithium-ion battery is extremely cold temperature.</li> </ul>	<ul style="list-style-type: none"> <li>Stop the vehicle at a safe place if the vehicle is under running.</li> <li>After the vehicle is in parking, in the daytime, wait for the outside temperature to rise and re-start the Plug-in Hybrid EV System if the outside temperature has been risen.</li> <li>Refer to "Cautions and actions to deal with intense cold" on page 3-13.</li> </ul>
	<ul style="list-style-type: none"> <li>Charging lid is open.</li> </ul>	<ul style="list-style-type: none"> <li>Close the charge lid.</li> <li>Refer to "Charging from rated AC 120 V outlet" on page 3-22.</li> </ul>

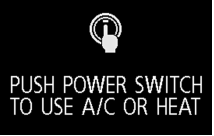



Indicator light, warning light, and information screen display list

Screen	Cause	Do this (Reference)
 <p>A/C AND HEAT ARE NOT AVAILABLE BATTERY CHARGE LOW</p>	<ul style="list-style-type: none"> <li>When the air conditioner stops because the main drive lithium-ion battery level becomes low by using the air conditioner during charging.</li> </ul>	<ul style="list-style-type: none"> <li>Turn the power switch to OFF once after charging the main drive lithium-ion battery sufficiently, and then turn the power switch to ON. The air conditioner can be used again.</li> </ul>
 <p>PUSH POWER SWITCH TO USE A/C OR HEAT</p>	<ul style="list-style-type: none"> <li>When the air conditioner can be used again in the following conditions. The main drive lithium-ion battery is enough charged while the “A/C AND HEAT ARE NOT AVAILABLE BATTERY CHARGE LOW” indication is displayed or the main drive lithium-ion battery is enough heated while the “BATTERY TOO COLD” indication is displayed, etc.</li> </ul>	<ul style="list-style-type: none"> <li>Turn the power switch to OFF once, and then turn the power switch to ON. The air conditioner can be used again.</li> </ul>
 <p>LARGE POWER USE CAN DRAIN BATTERY EVEN WHILE CHARGING</p>	<ul style="list-style-type: none"> <li>When the operation mode of the power switch is put in ON during charging.</li> </ul>	<ul style="list-style-type: none"> <li>The electric devices can be used during charging. Refer to “How to use electric device during charging” on page 3-42.</li> </ul>





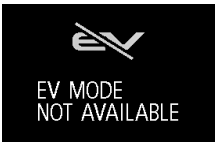

5

Indicator light, warning light, and information screen display list

5

Screen	Cause	Do this (Reference)
 <p>EV MODE NOT AVAILABLE BATTERY CHARGE LOW</p>	<ul style="list-style-type: none"> <li>● EV priority mode is not available because the main drive lithium-ion battery level is low.</li> </ul>	Refer to “EV switch” on page 5-66.
 <p>EV MODE NOT AVAILABLE CRUISE CONTROL SET</p>	<ul style="list-style-type: none"> <li>● EV priority mode is not available because the cruise control or the Adaptive Cruise Control System (ACC) is operating.</li> </ul>	
 <p>EV MODE NOT AVAILABLE BATTERY TOO COLD</p>	<ul style="list-style-type: none"> <li>● EV priority mode is not available because the main drive lithium-ion battery is too cold.</li> </ul>	
 <p>EV MODE NOT AVAILABLE</p>	<ul style="list-style-type: none"> <li>● EV priority mode is not available because the EV priority mode is limited to protect the Plug-in Hybrid EV System or outside temperature is too cold.</li> </ul>	
 <p>EV MODE CANCELED BATTERY CHARGE LOW</p>	<ul style="list-style-type: none"> <li>● EV priority mode is canceled because the main drive lithium-ion battery level is low.</li> </ul>	







Indicator light, warning light, and information screen display list

Screen	Cause	Do this (Reference)
 EV MODE CANCELED CRUISE CONTROL SET	<ul style="list-style-type: none"> <li>● EV priority mode is canceled because the vehicle speed of the cruise control or the Adaptive Cruise Control System (ACC) is set.</li> </ul>	Refer to “EV switch” on page 5-66.
 EV MODE CANCELED BATTERY TOO COLD	<ul style="list-style-type: none"> <li>● EV priority mode is canceled because the main drive lithium-ion battery temperature has become too cold.</li> </ul>	
 EV MODE CANCELED	<ul style="list-style-type: none"> <li>● EV priority mode is canceled because the protecting device of the Plug-in Hybrid EV System is operated.</li> </ul>	
 PLEASE WAIT NOW OPENING	<ul style="list-style-type: none"> <li>● There is preparing to open the fuel tank filler door.</li> </ul>	<ul style="list-style-type: none"> <li>● Wait until the preparation is complete. Refer to “Filling the fuel tank” on page 3-51.</li> </ul>
 READY TO REFUEL	<ul style="list-style-type: none"> <li>● Preparation to refuel has been completed and the fuel tank filler door opened.</li> </ul>	<ul style="list-style-type: none"> <li>● Please begin refueling. For information on how to refuel, refer to “Filling the fuel tank” on page 3-51.</li> </ul>
 REFUELING SYSTEM SERVICE REQUIRED	<ul style="list-style-type: none"> <li>● There is a fault in the refueling system.</li> </ul>	<ul style="list-style-type: none"> <li>● Contact a certified Mitsubishi EV dealer to have the system checked. Refer to “Filling the fuel tank” on page 3-51.</li> </ul>

5



Indicator light, warning light, and information screen display list

5

Screen	Cause	Do this (Reference)
 CLOSE FUEL LID AND CAP	<ul style="list-style-type: none"> <li>The fuel tank filler door is open.</li> </ul>	<ul style="list-style-type: none"> <li>Check the fuel tank filler cap is closed and then close the fuel tank filler door. Refer to “Filling the fuel tank” on page 3-51.</li> </ul>
 NOT AVAILABLE NOW	<ul style="list-style-type: none"> <li>SPORT mode is not available because the remaining fuel quantity is low.</li> </ul>	Refer to “SPORT mode switch” on page 5-71.
 CANCELLED	<ul style="list-style-type: none"> <li>SPORT mode is canceled because the remaining fuel quantity has become low.</li> </ul>	
 NOT AVAILABLE NOW	<ul style="list-style-type: none"> <li>Battery save mode or battery charge mode is not available because the engine coolant temperature is high or the remaining fuel quantity is low.</li> </ul>	Refer to “SAVE/CHARGE mode switch” on page 5-68.
 CANCELLED	<ul style="list-style-type: none"> <li>Battery save mode or battery charge mode is canceled because the engine coolant temperature has become high or the remaining fuel quantity has become low.</li> </ul>	
 TURN OFF LIGHTS	<ul style="list-style-type: none"> <li>You have forgotten to turn off the lights.</li> </ul>	Refer to “Light auto-cutout function (headlights and other lights)” on page 5-192.









Indicator light, warning light, and information screen display list

Screen	Cause	Do this (Reference)
 <p>LOW WASHER FLUID</p>	<ul style="list-style-type: none"> <li>The washer fluid is running low.</li> </ul>	<ul style="list-style-type: none"> <li>Replenish the container with washer fluid. Refer to “Washer fluid” on page 9-10. Refer to “Capacity” on page 11-9.</li> </ul>
 <p>LED HEADLIGHT SERVICE REQUIRED</p>	<ul style="list-style-type: none"> <li>There is a malfunction in the LED headlights.</li> </ul>	<ul style="list-style-type: none"> <li>Contact a certified Mitsubishi EV dealer to have the system checked. Refer to “LED headlight warning light” on page 5-192.</li> </ul>
	<ul style="list-style-type: none"> <li>The system has received the customer key programming request correctly and is currently processing the registration request.</li> </ul>	<p>Refer to “Customer F.A.S.T.-key programming (Except for vehicles sold in Canada)” on page 5-17.</p>







5

Indicator light, warning light, and information screen display list

5





Screen	Cause	Do this (Reference)
 KEY BATTERY LOW	<ul style="list-style-type: none"> <li>There is a fault in the F. A. S. T. -key.</li> </ul>	Refer to “Free-hand Advanced Security Transmitter (F.A.S.T.-key)” on page 5-4.
 KEY NOT DETECTED		
 KEY STILL IN VEHICLE		
 CHECK DOORS		
 KEYLESS OPERATION SYSTEM SERVICE REQUIRED		
 KEY NOT DETECTED INSERT KEY INTO KEY SLOT	<ul style="list-style-type: none"> <li>The F. A. S. T. -key is not detected.</li> </ul>	<ul style="list-style-type: none"> <li>Insert the F. A. S. T. -key into the key slot. Refer to “If the F. A. S. T. -key is not operating properly” on page 5-15.</li> </ul>

Indicator light, warning light, and information screen display list





Screen	Cause	Do this (Reference)
 REMOVE KEY FROM KEY SLOT	<ul style="list-style-type: none"> <li>You have forgotten to remove the F. A. S. T. -key from the key slot.</li> </ul>	<ul style="list-style-type: none"> <li>Remove the F. A. S. T. -key from the key slot.</li> </ul>
 POWER STEERING SERVICE REQUIRED	<ul style="list-style-type: none"> <li>There is a fault in the EPS.</li> </ul>	<ul style="list-style-type: none"> <li>Have the vehicle inspected by a certified Mitsubishi EV dealer as soon as possible. Refer to “Electric power steering system (EPS)” on page 5-80.</li> </ul>
 RBS! RBS SERVICE REQUIRED	<ul style="list-style-type: none"> <li>The RBS (regenerative brake system) cannot be used.</li> </ul>	<ul style="list-style-type: none"> <li>Contact a certified Mitsubishi EV dealer to have the system checked.</li> </ul>
 ABS SERVICE REQUIRED	<ul style="list-style-type: none"> <li>There is a fault in the Anti-lock braking system.</li> </ul>	<ul style="list-style-type: none"> <li>Avoid sudden braking and high-speed driving, park the vehicle in a safe place, and take corrective measures. Refer to “ABS warning light/display” on page 5-79.</li> </ul>
 LOW TIRE PRESSURE	<ul style="list-style-type: none"> <li>The tire pressure in one of the tires is low.</li> </ul>	Refer to “TPMS warning light/display” on page 5-122.
 TIRE PRESSURE MONITOR SERVICE REQUIRED	<ul style="list-style-type: none"> <li>There is a fault in the Tire Pressure Monitoring System.</li> </ul>	

5

## Indicator light, warning light, and information screen display list





Screen	Cause	Do this (Reference)
	<ul style="list-style-type: none"> <li>One of the doors or the liftgate is not completely closed. The open door is displayed.</li> </ul>	<ul style="list-style-type: none"> <li>Close the door or liftgate. Refer to “Door ajar warning display screen” on page 5-147.</li> </ul>
<b>5</b>  CLOSE HOOD	<ul style="list-style-type: none"> <li>The engine hood is open.</li> </ul>	<ul style="list-style-type: none"> <li>Close the engine hood. Refer to “Engine hood” on page 9-4.</li> </ul>
 IMMOBILIZER SYSTEM SERVICE REQUIRED	<ul style="list-style-type: none"> <li>There is a fault in the electronic immobilizer (Anti-theft starting system).</li> </ul>	<ul style="list-style-type: none"> <li>Put the operation mode in OFF, and then start the Plug-in Hybrid EV System again. If the warning is not canceled, please contact a certified Mitsubishi EV dealer.</li> </ul>
 OFF	<ul style="list-style-type: none"> <li>The driver's door is open when the operation mode is in any mode other than OFF.</li> </ul>	<ul style="list-style-type: none"> <li>Put the operation mode in OFF. Refer to “Operation mode ON reminder system” on page 5-26.</li> </ul>
	<ul style="list-style-type: none"> <li>An attempt was made to lock all the doors and the liftgate when the operation mode is in any mode other than OFF.</li> </ul>	<ul style="list-style-type: none"> <li>Put the operation mode in OFF. Refer to “Operation mode OFF reminder system” on page 5-12.</li> </ul>
 ELECTRICAL SYSTEM SERVICE REQUIRED	<ul style="list-style-type: none"> <li>There is a fault in the electrical system.</li> </ul>	<ul style="list-style-type: none"> <li>Park your vehicle in a safe place as soon as possible and contact a certified Mitsubishi EV dealer to have the system checked.</li> </ul>

Indicator light, warning light, and information screen display list



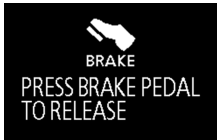

Screen	Cause	Do this (Reference)
 ENGINE OVERHEATING STOP SAFELY	<ul style="list-style-type: none"> <li>The engine is overheated.</li> </ul>	<ul style="list-style-type: none"> <li>Park the vehicle in a safe place and take corrective measures. Refer to “Engine overheating” on page 8-4.</li> </ul>
 FASTEN SEAT BELT	<ul style="list-style-type: none"> <li>The seat belt is not fastened when the operation mode is in ON.</li> </ul>	<ul style="list-style-type: none"> <li>Wear your seat belt properly. Refer to “Driver’s seat belt reminder/warning light and display” on page 4-20.</li> </ul>
 FUEL SYSTEM SERVICE REQUIRED	<ul style="list-style-type: none"> <li>There is a fault in the fuel system.</li> </ul>	<ul style="list-style-type: none"> <li>Contact a certified Mitsubishi EV dealer to have the system checked.</li> </ul>
 RELEASE PARKING BRAKE	<ul style="list-style-type: none"> <li>The vehicle is being driven with the parking brake still applied.</li> </ul>	<ul style="list-style-type: none"> <li>Release the parking brake. Refer to “Brake warning display” on page 5-189.</li> </ul>
 BRAKE SYSTEM SERVICE REQUIRED	<ul style="list-style-type: none"> <li>The brake fluid level is low.</li> <li>There is a fault in the brake system.</li> </ul>	<ul style="list-style-type: none"> <li>Park the vehicle in a safe place and inspect it.</li> <li>If the light still illuminates after the inspection, contact a certified Mitsubishi EV dealer for assistance. Refer to “Brake warning display” on page 5-189.</li> </ul>
	<ul style="list-style-type: none"> <li>When the brake pedal has been repeatedly depressed over a short period of time, the brake warning light may come on and the brake warning buzzer may sound, and this warning may be displayed.</li> </ul>	<ul style="list-style-type: none"> <li>If the this warning display is disappeared and brake warning light goes out and the buzzer stops a few seconds after stopping brake operation, there is no abnormality.</li> </ul>

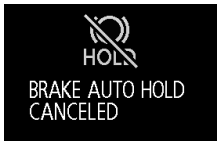
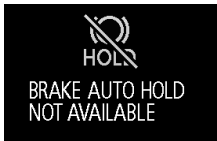
5

## Indicator light, warning light, and information screen display list





Screen	Cause	Do this (Reference)
	<ul style="list-style-type: none"> <li>There is a fault in the Electric parking brake.</li> </ul>	<ul style="list-style-type: none"> <li>Immediately have your vehicle inspected at a certified Mitsubishi EV dealer. Refer to “Electric parking brake” on page 5-45.</li> </ul>
<b>5</b> 	<ul style="list-style-type: none"> <li>The parking brake cannot be applied temporarily due to repeated operation of the Electric parking brake switch within a short time.</li> </ul>	Refer to “Electric parking brake” on page 5-45.
	<ul style="list-style-type: none"> <li>You try to release the Electric parking brake switch without depressing the brake pedal.</li> </ul>	Refer to “Electric parking brake” on page 5-45.
	<ul style="list-style-type: none"> <li>The Electric parking brake has been automatically applied.</li> </ul>	Refer to “Brake auto hold” on page 5-74.
	<ul style="list-style-type: none"> <li>The brake auto hold is automatically canceled.</li> </ul>	Refer to “Brake auto hold” on page 5-74.
	<ul style="list-style-type: none"> <li>The brake auto hold is not available.</li> </ul>	Refer to “Brake auto hold” on page 5-74.

Indicator light, warning light, and information screen display list

Screen	Cause	Do this (Reference)
 PUSH SWITCH AFTER FASTENING SEAT BELT	<ul style="list-style-type: none"> <li>The brake auto hold system does not turn on because the driver's seat belt is not fastened.</li> </ul>	<ul style="list-style-type: none"> <li>Press the brake auto hold switch after fastening the driver's seat belt. Refer to "Brake auto hold" on page 5-74.</li> </ul>
 BRAKE PUSH SWITCH WHILE APPLYING BRAKE	<ul style="list-style-type: none"> <li>The brake auto hold system does not turn off because the brake pedal is not pressed.</li> </ul>	<ul style="list-style-type: none"> <li>Depress the brake pedal more firmly than usual with the right foot. Then, press the brake auto hold switch. Refer to "Brake auto hold" on page 5-74.</li> </ul>
 LOW OIL PRESSURE	<ul style="list-style-type: none"> <li>There is a fault in the engine oil circulation system.</li> </ul>	<ul style="list-style-type: none"> <li>Park your vehicle in a safe place as soon as possible and contact a certified Mitsubishi EV dealer to have the system checked. Refer to "Oil pressure warning display" on page 5-190.</li> </ul>
 AIRBAG SYSTEM SERVICE REQUIRED	<ul style="list-style-type: none"> <li>There is a fault in the SRS airbag or the pre-tensioner system.</li> </ul>	<ul style="list-style-type: none"> <li>Contact a certified Mitsubishi EV dealer to have the system checked, immediately. Refer to "SRS warning light/display" on page 4-42.</li> </ul>
 ASC SYSTEM SERVICE REQUIRED	<ul style="list-style-type: none"> <li>There is a fault in the Active stability control (ASC).</li> </ul>	<ul style="list-style-type: none"> <li>Contact a certified Mitsubishi EV dealer to have the system checked. Refer to "Active stability control (ASC)" on page 5-81.</li> </ul>
	<ul style="list-style-type: none"> <li>There is a fault in the Hill start assist.</li> </ul>	<ul style="list-style-type: none"> <li>Have the vehicle checked at a certified Mitsubishi EV dealer. Refer to "Hill start assist" on page 5-77.</li> </ul>







Indicator light, warning light, and information screen display list

5





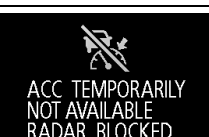

Screen	Cause	Do this (Reference)
 REFUEL	<ul style="list-style-type: none"> <li>The fuel is running low.</li> </ul>	<ul style="list-style-type: none"> <li>Refuel as soon as possible. Refer to “Fuel remaining display screen” on page 5-147.</li> </ul>
 POSSIBLE ICY ROADS	<ul style="list-style-type: none"> <li>The outside temperature is 37 °F (3 °C) or less.</li> </ul>	<ul style="list-style-type: none"> <li>Be careful driving on frozen ground.</li> <li>The ground may be frozen even when this warning is not displayed, so drive carefully.</li> </ul>
 BRAKE!	<ul style="list-style-type: none"> <li>The Adaptive Cruise Control System (ACC) has detected the approach of the vehicles in front.</li> </ul>	<ul style="list-style-type: none"> <li>Increase the following distance by depressing the brake pedal or making other decelerating control. Refer to “Adaptive Cruise Control System (ACC): Approach alarm” on page 5-93.</li> </ul>
	<ul style="list-style-type: none"> <li>The Forward Collision Mitigation System (FCM) has detected the danger of collision.</li> </ul>	<ul style="list-style-type: none"> <li>Take appropriate action such as depressing the brake to avoid collision. Refer to “Forward collision warning function” on page 5-101.</li> </ul>
 APPLY BRAKE	<ul style="list-style-type: none"> <li>The Adaptive Cruise Control System (ACC) detected a stop of the vehicle in front and stopped your vehicle, but the brake will be released soon.</li> </ul>	<ul style="list-style-type: none"> <li>Depress the brake pedal as soon as your vehicle comes to a stop. Refer to “When ACC detects a vehicle in front within the set distance” on page 5-92.</li> </ul>
	<ul style="list-style-type: none"> <li>The Electric parking brake cannot be applied automatically.</li> </ul>	<ul style="list-style-type: none"> <li>Depress the brake pedal as soon as possible. Refer to “Brake auto hold” on page 5-74.</li> </ul>





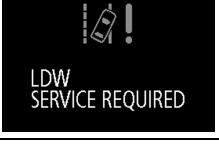

Indicator light, warning light, and information screen display list

Screen	Cause	Do this (Reference)	
 ACC NOT AVAILABLE NOW	<ul style="list-style-type: none"> <li>● Conditions for the start of control are not met, the Adaptive Cruise Control System (ACC) cannot start the control.</li> </ul>	Refer to “How to use ACC” on page 5-90.	
 ACC OUT OF SPEED RANGE	<ul style="list-style-type: none"> <li>● The Adaptive Cruise Control System (ACC) cannot start the control because the speed is out of speed range.</li> </ul>		
 ACC NO FORWARD VEHICLE	<ul style="list-style-type: none"> <li>● The Adaptive Cruise Control System (ACC) cannot start the control because not detected the approach of the vehicles in front.</li> </ul>		
 ACC CANCELLED	<ul style="list-style-type: none"> <li>● The Adaptive Cruise Control System (ACC) control is automatically canceled and the system is placed in the ‘standby’ state.</li> </ul>		
 ACC TEMPORARILY NOT AVAILABLE RADAR BLOCKED	<ul style="list-style-type: none"> <li>● The Adaptive Cruise Control System (ACC) is temporarily unavailable due to conditions such as the adhesion of contaminants to the sensor. This is not a malfunction.</li> </ul>		Refer to “To cancel ACC control” on page 5-97.
 ACC SERVICE REQUIRED	<ul style="list-style-type: none"> <li>● There is a fault in the Adaptive Cruise Control System (ACC).</li> </ul>		<ul style="list-style-type: none"> <li>● Contact a certified Mitsubishi EV dealer to have the system checked.</li> </ul> Refer to “Warning display” on page 5-99.

## Indicator light, warning light, and information screen display list

Screen	Cause	Do this (Reference)
 FCM BRAKE ACTIVATED	<ul style="list-style-type: none"> <li>FCM braking function of the Forward Collision Mitigation System (FCM) has been activated.</li> </ul>	Refer to “FCM braking function” on page 5-101.
<b>5</b>  FCM TEMPORARILY NOT AVAILABLE	<ul style="list-style-type: none"> <li>The Forward Collision Mitigation System (FCM) is temporarily unavailable for some reason.</li> </ul>	Refer to “Forward Collision Mitigation System (FCM): System problem warning” on page 5-105.
 FCM! FCM SERVICE REQUIRED	<ul style="list-style-type: none"> <li>There is a fault in the Forward Collision Mitigation System (FCM).</li> </ul>	<ul style="list-style-type: none"> <li>Contact a certified Mitsubishi EV dealer to have the system checked.</li> <li>Refer to “Forward Collision Mitigation System: System problem warning” on page 5-105.</li> </ul>
 LANE DEPARTURE	<ul style="list-style-type: none"> <li>The Lane Departure Warning system (LDW) has detected that your vehicle is about to leave or has left the lane.</li> </ul>	Refer to “Lane Departure Warning system (LDW)” on page 5-118.
 LDW SERVICE REQUIRED	<ul style="list-style-type: none"> <li>There is a fault in the Lane Departure Warning system (LDW).</li> </ul>	<ul style="list-style-type: none"> <li>Contact a certified Mitsubishi EV dealer to have the system checked.</li> <li>Refer to “Lane Departure Warning system (LDW): System problem warning” on page 5-120</li> </ul>
 BSW TEMPORARILY NOT AVAILABLE	<ul style="list-style-type: none"> <li>The Blind Spot Warning (BSW) sensor is temporarily not available for some reason such as the environmental condition or increase of the sensor temperature.</li> </ul>	<ul style="list-style-type: none"> <li>When the warning display does not disappear after waiting for a while, contact a certified Mitsubishi EV dealer.</li> <li>Refer to “Blind Spot Warning (BSW): When the sensor is temporarily not available” on page 5-112.</li> </ul>



Indicator light, warning light, and information screen display list

Screen	Cause	Do this (Reference)
 <p>BSW SERVICE REQUIRED</p>	<ul style="list-style-type: none"> <li>The Blind Spot Warning (BSW) does not operate normally because there are some malfunctions in the sensor or the system.</li> </ul>	<ul style="list-style-type: none"> <li>Immediately have your vehicle inspected at a certified Mitsubishi EV dealer. Refer to “Blind Spot Warning (BSW): When there is a malfunction in the system or the sensor” on page 5-112.</li> </ul>
 <p>BSW RADAR BLOCKED</p>	<ul style="list-style-type: none"> <li>Foreign objects, such as dirt, snow or ice, adhere to the bumper surface around the sensor.</li> </ul>	<ul style="list-style-type: none"> <li>Remove a foreign object on the bumper surface around the sensor. When the warning display does not disappear after having cleaned the bumper surface around the sensor, contact a certified Mitsubishi EV dealer. Refer to “Blind Spot Warning (BSW): When there are foreign objects on the sensor.” on page 5-112.</li> </ul>
 <p>ATTENTION! REAR CROSS TRAFFIC</p>	<ul style="list-style-type: none"> <li>The Rear Cross Traffic Alert (RCTA) is detected the vehicle approaching your vehicle.</li> </ul>	<ul style="list-style-type: none"> <li>Pay special attention to the rear of your vehicle. Refer to “Rear Cross Traffic Alert (RCTA)” on page 5-114.</li> </ul>
 <p>DRIVER ASSISTANCE CAMERA SERVICE REQUIRED</p>	<ul style="list-style-type: none"> <li>There is a fault in the sensor.</li> </ul>	<ul style="list-style-type: none"> <li>Contact a certified Mitsubishi EV dealer. Refer to “Forward Collision Mitigation System (FCM): System problem warning” on page 5-105. Refer to “Lane Departure Warning System (LDW): System problem warning” on page 5-120. Refer to “Automatic High Beam (AHB): System problem warning” on page 5-196.</li> </ul>

5

Indicator light, warning light, and information screen display list



5

Screen	Cause	Do this (Reference)
 <p>DRIVER ASSISTANCE CAMERA TEMPORARILY NOT AVAILABLE</p>	<ul style="list-style-type: none"> <li>The Forward Collision Mitigation System (FCM), Lane Departure Warning system (LDW) and Automatic High Beam (AHB) is temporarily unavailable due to the high or low temperature of the sensor.</li> </ul>	<ul style="list-style-type: none"> <li>After the temperature of the sensor has been in range, the system will automatically return to operation. Refer to “Forward Collision Mitigation System (FCM): System problem warning” on page 5-105. Refer to “Lane Departure Warning System (LDW): System problem warning” on page 5-120. Refer to “Automatic High Beam (AHB): System problem warning” on page 5-196.</li> </ul>
 <p>DRIVER ASSISTANCE CAMERA BLOCKED</p>	<ul style="list-style-type: none"> <li>The sensor is temporarily unavailable due to conditions such as the adhesion of contaminants to the sensor or windshield. This is not a malfunction.</li> </ul>	<ul style="list-style-type: none"> <li>Refer to “Forward Collision Mitigation System (FCM): System problem warning” on page 5-105. Refer to “Lane Departure Warning System (LDW): System problem warning” on page 5-120. Refer to “Automatic High Beam (AHB): System problem warning” on page 5-196.</li> </ul>
 <p>AHB SERVICE REQUIRED</p>	<ul style="list-style-type: none"> <li>There is a fault in the system of Automatic High Beam (AHB).</li> </ul>	<ul style="list-style-type: none"> <li>Contact a certified Mitsubishi EV dealer. Refer to “Automatic High Beam (AHB): System problem warning” on page 5-196.</li> </ul>

Indicator light, warning light, and information screen display list

Other interrupt displays

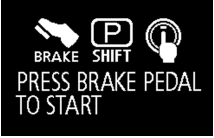

N00558201470

Screen	Cause	Do this (Reference)
	<ul style="list-style-type: none"> <li>When you pressed the power switch and the operation mode become the ACC without depress the brake pedal, this screen is displayed. This screen will be displayed repeatedly at regular intervals while the operation mode of the power switch is put in ACC.</li> </ul>	<ul style="list-style-type: none"> <li>Place the select position in the “P” (PARK) position, depress the brake pedal more firmly than usual with the right foot. Then, press the power switch. Refer to “Starting the Plug-in Hybrid EV System” on page 5-14.</li> </ul>
	<ul style="list-style-type: none"> <li>When Plug-in Hybrid EV System does not start even if the operation mode of the power switch is put in ON, this screen is displayed.</li> </ul>	
	<ul style="list-style-type: none"> <li>When starting the Plug-in Hybrid EV System, you pressed the power switch without select position in the “P” (PARK) position.</li> </ul>	<ul style="list-style-type: none"> <li>Place the select position in the “P” (PARK) position by pressing the electrical parking switch, depress the brake pedal more firmly than usual with the right foot. Then, press the power switch. Refer to “Starting the Plug-in Hybrid EV System” on page 5-14.</li> </ul>
	<ul style="list-style-type: none"> <li>Driving power is restricted by the safety system as the Plug-in Hybrid EV System has become too hot or too cold.</li> </ul>	<ul style="list-style-type: none"> <li>You do not have to take any actions. The restriction on the driving power will be released when the Plug-in Hybrid EV System returns to the normal temperature.</li> </ul>



5

Indicator light, warning light, and information screen display list

5

Screen	Cause	Do this (Reference)
	<ul style="list-style-type: none"> <li>The vehicle had not been refueled approximately 4 gallons (15 liters) or more at one time for nearly 3 months. This display may appear frequently depending on the use conditions of your vehicle such as when the fuel has been staying in the fuel tank for a long time.</li> </ul>	<ul style="list-style-type: none"> <li>Refill the 4 gallons (15 liters) more at one time. This display will disappear. If the fuel remaining display will be below half, you can refill the fuel more than 4 gallons (15 liters) certainly.</li> <li>If you cannot refill the fuel due to large amount of the remaining fuel, start the engine and drive the vehicle enough to reduce the fuel level to approximately half tank.</li> </ul>
	<ul style="list-style-type: none"> <li>If the vehicle had not been refueled approximately 4 gallons (15 liters) or more at one time for three months, the engine starts automatically for the maintenance of the engine or the fuel system components while the ready indicator is illuminated. This display may appear frequently depending on the use conditions of your vehicle such as when the fuel has been staying in the fuel tank for a long time. When the engine is running, the main drive lithium-ion battery is charged and the battery charge mode display (CHARGE) is displayed, but the main drive lithium-ion battery will not be full charge.</li> </ul>	<ul style="list-style-type: none"> <li>Refill the 4 gallons (15 liters) more at one time. This display and battery charge mode display will disappear, and the engine will not automatically start for maintenance. If the fuel remaining display will be below half, you can refill the fuel more than 4 gallons (15 liters) certainly.</li> <li>If you cannot refill the fuel due to large amount of the remaining fuel, start the engine and drive the vehicle enough to reduce the fuel level to approximately half tank.</li> </ul>

Indicator light, warning light, and information screen display list

Screen	Cause	Do this (Reference)
	<ul style="list-style-type: none"> <li>The accelerator pedal has been depressed when the select position is in the “N” (NEUTRAL) position.</li> </ul>	<ul style="list-style-type: none"> <li>When you start the vehicle, be sure to check the select position display and make sure the select position is in the “D” (DRIVE) or “R” (REVERSE) position. Then depress the accelerator pedal. Refer to “Select Position display” on page 5-58.</li> </ul>
	<ul style="list-style-type: none"> <li>The selector lever has been operated when the select position is in “P” (PARK) position and the brake pedal is not depressed.</li> </ul>	<ul style="list-style-type: none"> <li>Operate the selector lever while depressed firmly on the brake pedal.</li> </ul>



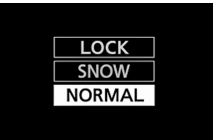

5

The operation status of each system is displayed on the information screen. For further details, refer to the appropriate page for each system.

Screen	System operation status	Reference
	<ul style="list-style-type: none"> <li>When charging of the main drive lithium-ion battery is completed.</li> </ul>	Refer to “Normal charging” on page 3-20.
	<ul style="list-style-type: none"> <li>When “NORMAL” mode of S-AWC is selected.</li> </ul>	Refer to “S-AWC drive mode” on page 5-62.

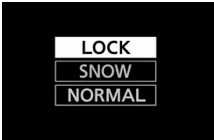

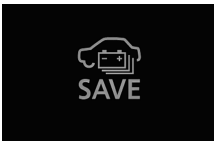

Indicator light, warning light, and information screen display list

5

Screen	System operation status	Reference
	<ul style="list-style-type: none"> <li>When "SNOW" mode of S-AWC is selected.</li> </ul>	Refer to "S-AWC drive mode" on page 5-62.
	<ul style="list-style-type: none"> <li>When "LOCK" mode of S-AWC is selected.</li> </ul>	Refer to "S-AWC drive mode" on page 5-62.
	<ul style="list-style-type: none"> <li>When the mode is changed by the ECO mode switch.</li> </ul>	Refer to "ECO mode switch" on page 5-199.
	<ul style="list-style-type: none"> <li>When the EV priority mode is activated.</li> </ul>	Refer to "EV switch" on page 5-66.
	<ul style="list-style-type: none"> <li>When the battery save mode is activated.</li> </ul>	Refer to "Battery save mode" on page 5-69.
	<ul style="list-style-type: none"> <li>When the battery charge mode is activated.</li> </ul>	Refer to "Battery charge mode" on page 5-69.

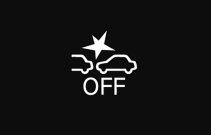

Indicator light, warning light, and information screen display list

Screen	System operation status	Reference
	<ul style="list-style-type: none"> <li>When the SPORT mode is activated.</li> </ul>	Refer to “SPORT mode switch” on page 5-71.
  	<ul style="list-style-type: none"> <li>When the Forward Collision Mitigation System (FCM) is activated or the timing of an alarm is changed.</li> </ul>	Refer to “FCM ON/OFF switch” on page 5-104.
	<ul style="list-style-type: none"> <li>When the Forward Collision Mitigation System (FCM) is deactivated.</li> </ul>	Refer to “FCM ON/OFF switch” on page 5-104.

**5**

This informs you that a periodic inspection is due.

Screen	Do this
	Have an inspection made by a certified Mitsubishi EV dealer. For further details, refer to “Service reminder” on page 5-149.

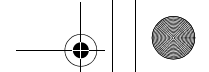

## Indicators

The rest time can be set.

5

Screen	Do this
	<p>Park the vehicle in a safe place, stop the Plug-in Hybrid EV System, and take a rest. Use this display as rough guide for taking rests during a long drive. The interval from the start of your trip until this message is displayed can be set. Refer to “Changing the function settings” on page 5-153. The display and buzzer alert the driver when the set time is reached. If you continue to drive without having a rest, the buzzer sounds approximately every 5 minutes to encourage you to take a rest.</p> <ul style="list-style-type: none"> <li>● In the following cases, the time driven is reset and the display returns to the previous display screen. After this, when the set time is reached again, the display and buzzer encourage you to take a rest. <ul style="list-style-type: none"> <li>• The buzzer sounds 3 times.</li> <li>• The operation mode is put in OFF.</li> <li>• The multi-information display switch is held (for approximately 2 seconds or more).</li> </ul> </li> </ul>

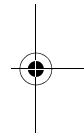

### Indicators

N00519900127

#### Turn signal indicators/Hazard warning lights

N00520000216

The arrows will flash in time with the corresponding exterior turn signals when the turn signal lever is used.

Both arrows will flash when the hazard warning flasher switch is pressed.

### NOTE

- If the indicator flashes faster than usual or if the indicator stays on without flashing, check for a malfunctioning turn signal light bulb or turn signal connection.

#### High beam indicator

N00520100086

A blue light comes on when the headlights are on high beam.

#### Front fog light indicator

N00520201257

This indicator comes on while the front fog lights are on.

#### Position indicator

N00551301065

This indicator light illuminates while the parking lights are on.

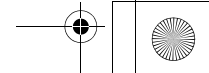
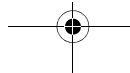

## Ready indicator

N00573201035

The ready indicator keeps flashing until Plug-in Hybrid EV System is activated. When the Plug-in Hybrid EV System has activated normally and the vehicle becomes ready to run, the indicator stops flashing and stays lit. Refer to “Starting the Plug-in Hybrid EV System” on page 5-14.

If the indicator keeps flashing, the vehicles cannot drive.

## Charging indicator

N00573301049

This indicator flashes when the EV charging cable (normal charger or quick charger) is connected.

After that, the indicator switches to being illuminated when charging starts and goes out when charging is completed.

### NOTE

- Although it is possible to start the Plug-in Hybrid EV System if quick charging has not finished normally, the charging indicator is continuously blinking. Refer to “Charging troubleshooting guide” on page 3-46.

## Warning lights

N00520300147

### Brake warning light and buzzer

N00520401608

This light comes on when the operation mode is put in ON, and goes off after a few seconds. Always make sure that the light goes off before driving.

A warning is also displayed in the multi-information display.

The warning light also illuminates after starting the Plug-in Hybrid EV system under the following conditions.

- When the parking brake is still applied.
- When the brake fluid level is low.
- When the brake system circuit is not working properly.

When the vehicle is moving at more than 5 mph (8 km/h) and parking brake applied, a buzzer will sound to inform the driver that the parking brake is not properly release.

Before driving, be sure that the parking brake is fully released and brake warning light is off.

### CAUTION

- If the brake warning light and the Anti-lock braking system warning light are illuminated at the same time, the braking force distribution function will not operate, so the vehicle may be destabilized during sudden braking under the following conditions.

- When the brake warning light does not go out even when the parking brake is released.
- When the brake warning light stays on while driving.
- If the above occurs, avoid sudden braking and high-speed driving. Park the vehicle in a safe place, and contact a certified Mitsubishi EV dealer as soon as possible.

- The vehicle should be brought to a halt in the following manner when brake performance is deteriorated.

- Confirm that the vehicle slows down when you press down on the brake pedal harder than usual. In some cases, the brake pedal may go all the way to the floor.
- Should the brakes fail, use regenerative brake to reduce your speed and keep pulling the Electric parking brake switch. (Refer to “Electric parking brake” on page 5-45)

Depress the brake pedal to illuminate the stop lights to alert the vehicles behind you.

5

## Warning lights

### Electric parking brake warning light

N00591200072

This warning light will illuminate when there is a fault in the Electric parking brake system. Normally, this warning light illuminates when the operation mode is put in ON, and goes off in a few seconds.

5

#### CAUTION

- When the warning light remains on or does not come on, there is the possibility that the parking brake cannot be operated or released. Immediately contact the nearest certified Mitsubishi EV dealer. When the warning light comes on during driving, immediately stop the vehicle in a safe place, and contact a certified Mitsubishi EV dealer. If you inevitably have to park, park the vehicle on level and stable ground, shift the select position in "P" (PARK) position and place chocks or blocks.

### Engine malfunction indicator ("SERVICE ENGINE SOON" or "Check engine light")

N00520501843

This indicator is a part of the onboard diagnostic (OBD) system which monitors the emissions or engine control system. If a prob-

lem is detected in one of these systems, this indicator illuminates or flashes. When the operation mode is put in ON, this indicator normally comes on and goes off after the Plug-in Hybrid EV system has started.

This indicator will come on if the fuel tank filler cap is not properly tightened. If this indicator comes on and stays on after refueling, stop the Plug-in Hybrid EV system and check that the cap is properly tightened. (Turn the cap clockwise until you hear clicking sounds.)

If this indicator does not go off after several seconds or lights up while driving, have the system checked as soon as possible at a certified Mitsubishi EV dealer.

#### CAUTION

- Driving for a long time with the engine malfunction indicator on may cause more damage to the emission control system. This could also affect fuel economy and drivability.
- If this indicator does not come on when the operation mode is put in ON, have the system checked at a certified Mitsubishi EV dealer.

#### CAUTION

- If the engine malfunction indicator comes on while the Plug-in Hybrid EV system is running, avoid driving at high speeds. During vehicle operation with the indicator on, the vehicle may not accelerate when you depress the accelerator pedal.

#### NOTE

- Do not disconnect the 12 V starter battery cable when the engine malfunction indicator ("SERVICE ENGINE SOON" or "Check engine light") is on. The engine electronic control module stores critical OBD information (especially exhaust emission data), which may be lost if the 12 V starter battery cable is disconnected while the engine malfunction indicator is on. This will make it difficult to diagnose the cause of future problems.

### 12 V starter battery charging system warning light

N00520601336

This light comes on in the event of a malfunction in the charging system or when the operation mode is put in ON. When the Plug-in Hybrid EV System is started and the ready indicator illuminates, the light should go out.

## Information screen display

Check to make sure that the light has gone out before driving.

### CAUTION

- If the warning light stays on after the ready indicator illuminates, there may be a problem with the charging system for the 12 V starter battery.
- Immediately park your vehicle in a safe place and contact a certified Mitsubishi EV dealer to have the system checked.
- Do not charge the 12 V starter battery.

### Plug-in Hybrid EV System warning light

N00588800032

This warning light will illuminate when there is a fault at the Plug-in Hybrid EV System. Refer to “Service precautions” on page 9-2. Normally, this warning light illuminates when the operation mode of the power switch is put in ON, and goes off after a few seconds.

### CAUTION

- If the warning light illuminates and “EV SYSTEM SERVICE REQUIRED STOP SAFELY” warning is displayed on the multi-information display while the Plug-in Hybrid EV System is running, park your vehicle in a safe place as soon as possible and contact a certified Mitsubishi EV dealer to have the system checked.



### Regenerative brake warning light

N00588900033

This warning light will illuminate when the regenerative brake cannot be used, while the Plug-in Hybrid EV System is running. The warning is also displayed on the multi-information display. Normally, this warning light illuminates when the operation mode of the power switch is put in ON, and goes off after the Plug-in Hybrid EV System is activated.

### CAUTION

- If the light illuminates while the Plug-in Hybrid EV System is operating, we recommend you to have the vehicle inspected by a certified Mitsubishi EV dealer.

### Information screen display

5

N00558301051

### Brake warning display

N00558401195



This warning is displayed if the vehicle is being driven with the parking brake still applied. The warning light in the instrument cluster only comes on when the parking brake is applied.

### CAUTION

- If a vehicle is driven without releasing the parking brake, the brakes will overheat, resulting in ineffective braking and possible brake failure. If this warning is displayed, release the parking brake.

## Combination headlights and dimmer switch



5

When the operation mode of the power switch is put in ON, if the brake fluid is low, this warning is displayed. The warning light in the instrument cluster also illuminates.

### CAUTION

- If this warning stays on and does not go out while driving, there is a danger of ineffective braking. If this happens, park the vehicle in a safe place, and contact a certified Mitsubishi EV dealer.
- If the brake warning display, brake warning light, and the Anti-lock braking system warning light are illuminated at the same time, the braking force distribution function will not operate, so the vehicle may be destabilized during sudden braking. Avoid sudden braking and high-speed driving. Park the vehicle in a safe place, and contact a certified Mitsubishi EV dealer.
- The vehicle should be brought to a stop when brake performance has deteriorated.
  - Confirm that the vehicle slows down when you press down on the brake pedal harder than usual. In some cases, the brake pedal may go all the way to the floor.

### CAUTION

- Should the brakes fail, use regenerative braking to reduce your speed and keep pulling the Electric parking brake switch. (Refer to “Electric parking brake” on page 5-45)
- Depress the brake pedal to illuminate the stop lights to alert the vehicles behind you.

## Oil pressure warning display

N00558701130



If the engine oil pressure drops while the Plug-in Hybrid EV System is running, the warning display is displayed on the information screen in the multi-information display.

### CAUTION

- If the vehicle is driven while the engine oil is low, or the oil level is normal but the warning is displayed, the engine may overheat and damage may result.
- If the warning is displayed while the Plug-in Hybrid EV System is running, park your vehicle in a safe place as soon as possible and check the engine oil level.

### CAUTION

- If this warning display comes on when the engine oil level is proper, have your vehicle checked at a certified Mitsubishi EV dealer.

### NOTE

- The oil pressure warning display does not show the amount of oil. The oil level must be checked using the dipstick.

## Combination headlights and dimmer switch

N00522502004

## Headlights

### NOTE

- Do not leave the headlights and other lights on for a long period of time when the Plug-in Hybrid EV System is not running. The 12 V starter battery will run down.

### Combination headlights and dimmer switch

#### NOTE

- When it rains, or when the vehicle has been washed, the inside of the lens sometimes becomes foggy. This is the same as when window glass mists up on a humid day, and does not indicate a problem. When the light is switched on, the heat will dry out the fog. However, if water collects inside the light, have it checked by a certified Mitsubishi EV dealer.

Rotate the switch to operate the lights.

#### Vehicles without "OFF" position

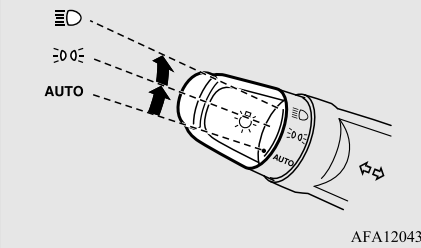

The combinations of switch operations and illuminated lights differ in accordance with the following conditions.

[When the Plug-in Hybrid EV System is started, and the parking brake is released]

OFF	The daytime running lights illuminated
AUTO	The daytime running lights illuminated (when it is light outside the vehicle) Headlights and other lights turn on and off automatically in accordance with outside light level.
☰☪☺	The daytime running lights illuminated Tail, front and rear side-marker lights, license plate, instrument panel lights and downlight on

☰☪☺ Headlights and other lights on

#### NOTE

- Once the daytime running light come on, they do not go out until the operation mode is changed to OFF or ACC.

5

[When the Plug-in Hybrid EV System is not running, or when the Plug-in Hybrid EV System is running but the parking brake is not released]

The Plug-in Hybrid EV System starts when the lights are off.

OFF	All lights off
AUTO	Headlights and other lights turn on and off automatically in accordance with outside light level.
☰☪☺	Parking, tail, front and rear side-marker lights, license plate, instrument panel lights and downlight on
☰☪☺	Headlights and other lights on

## Combination headlights and dimmer switch

5

### NOTE

- On vehicles with “OFF” position, the sensitivity of the automatic on/off control can be adjusted.  
For further information, please contact a certified Mitsubishi EV dealer.  
On vehicles equipped with the Smartphone-link Display Audio (SDA), screen operations can be used to make the adjustment. Refer to the separate owner’s manual for details.
- Do not cover the sensor (A) for the automatic on/off control by affixing a sticker or label to the windshield.

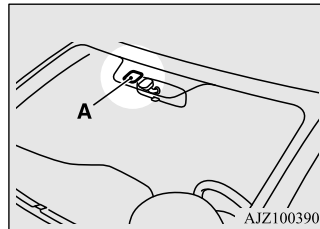

- If the lights do not turn on or off with the switch in the “AUTO” position, manually operate the switch. Have the system checked by a certified Mitsubishi EV dealer.

### Light auto-cutout function (headlights and other lights)

N00532601681

- If the operation mode is changed to OFF or ACC and the driver’s door is opened with the combination headlights and dimmer switch in the “☰☱☲” or “☱☲☳” position, the lights automatically turn off.
- If the operation mode is changed to OFF or ACC and the driver’s door is not opened with the combination headlights and dimmer switch in the “☰☱☲” or “☱☲☳” position, the lights automatically turn off after approximately 3 minutes.

### NOTE

- The light auto-cutout function can be deactivated.  
See a certified Mitsubishi EV dealer for details.  
For vehicles equipped with the Smartphone-link Display Audio (SDA), adjustments can be made using screen operations. For further details, refer to the separate owner’s manual.

### When you want to keep the lights on:

If the combination headlights and dimmer switch is turned to the “☰☱☲” or “☱☲☳” posi-

tion again after stopping the Plug-in Hybrid EV System, the approximately 3-minute auto-cutout function described above will not work. The lights (the parking lights, tail lights and license plate lights) will stay on and will not turn off automatically.

### LED headlight warning light (if so equipped)

N00584500031

This warning light will illuminate when there is a malfunction in the LED headlights.

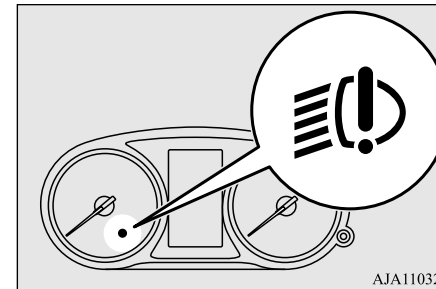

### NOTE

- If the warning light illuminates, there may be a malfunction in the unit. Contact a certified Mitsubishi EV dealer to have the system checked.



Combination headlights and dimmer switch

**Headlight reminder buzzer**

N00549801265

If the driver's door is opened with the operation mode is put in OFF or ACC, or if the operation mode is changed to OFF while the lights are on, the tone will sound to remind you to turn off the lights.

In either case, the lights will turn off automatically and so will the tone. Or you can turn the light switch to the "OFF" position (if so equipped) or "AUTO" position to stop the tone.

**Dimmer (high/low beam change)**

N00549901178

To change the headlights from high beam to low beam and vice versa, pull the turn signal lever to (1). Switch the headlights to low beam as a courtesy whenever there are oncoming vehicles, or when there is traffic moving ahead of you. An illuminated blue light in the instrument cluster indicates when the headlights are on high beam.

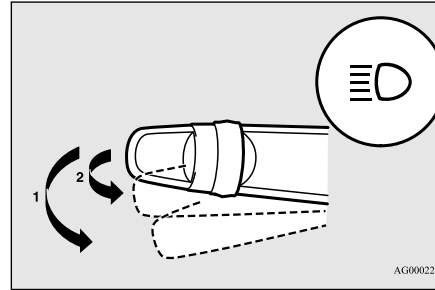

AG0002299

**Headlight flasher**

N00550001212

You can flash the high beams by pulling the lever gently toward you (2). The lights will go back to normal when you let go. While the high beam is on, you will see a blue light on the instrument panel.

**NOTE**

- You can flash the high beams by pulling the lever toward you, even if the light switch is off.
- If you turn the lights off with the head lights set to high beam illumination, the headlights are automatically returned to their low-beam setting when the light switch is next turned to the "D" position.

**Automatic High Beam (AHB) (if so equipped)**

N00591300073

The Automatic High Beam (AHB) turns the high beam light on or off automatically according to surrounding light conditions. The sensor (A) detects lights, such as the lights of an oncoming vehicle, a vehicle ahead or street lights.

**5**

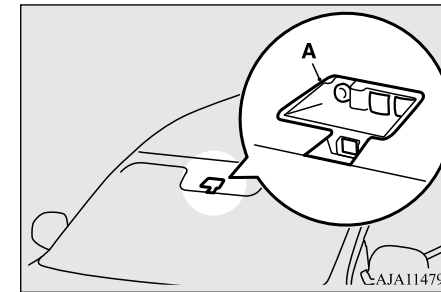

AJA114790

**WARNING**

- Do not rely solely on the AHB. Always observe surrounding traffic and light conditions. If necessary, manually turn the high beams on or off. Refer to "Dimmer (high/low beam change)" on page 5-193.

## Combination headlights and dimmer switch

### How to use the AHB

N00593600096

1. Rotate the light switch to “” position or “AUTO” position when the Plug-in Hybrid EV System is running.
2. Press the AHB switch.

The AHB is activated and the indicator is illuminated.

If the AHB switch is pressed again, the AHB will be deactivated and AHB indicator will go off.

5

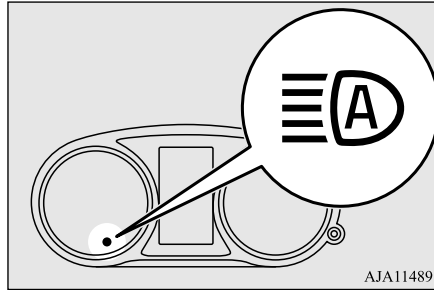
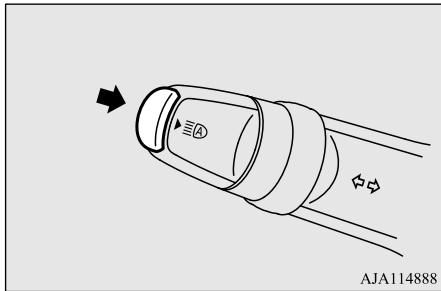

### NOTE

- If the headlights are on when the light switch is in the “AUTO” position, the AHB works.
- You can switch the headlight beams (high/low) manually by operating the lever even if the AHB is working. Refer to “Dimmer (high/low beam change)” on page 5-193. If the lever is operated manually, the AHB indicator will go off and the AHB will be deactivated. Refer to “Manual switching” on page 5-194.
- The AHB is not deactivated when you pull the lever slightly (operation of the headlight flasher).

### Manual switching

#### Switching to low beam

1. Pull the turn signal lever toward you.

2. The AHB indicator will go off.
3. The AHB switch is pressed again, the AHB will be activated.

#### Switching to high beam

1. Pull the turn signal lever toward you.
2. The AHB indicator will go off and the high beam indicator illuminates.
3. The AHB switch is pressed again, the AHB will be activated.

### Automatic switching conditions

N00593700068

The high beam headlights illuminate when all of the following conditions are met:

- Your vehicle speed exceeds approximately 33 mph (53 km/h).
- It is dark ahead of your vehicle.
- There are no vehicles in front or oncoming vehicles, or none of their exterior lights are illuminating.

The low beam headlights illuminate when any of the following conditions occur:

- Your vehicle speed does not exceed approximately 28 mph (45 km/h).
- It is bright ahead of your vehicle.
- An exterior light of a vehicle in front or oncoming vehicle is illuminating.

## Combination headlights and dimmer switch

 **NOTE**

- The headlights may not be switched from high beam to low beam under the following circumstances.
  - A vehicle in front or oncoming vehicle is hindered by any object such as continuous bends, elevated median/island, traffic signs, roadside trees.
  - Your vehicle passes an oncoming vehicle suddenly on a bend with poor visibility.
  - Another vehicle crosses ahead of your vehicle.
- The headlights may remain at low beam (or be switched from high beam to low beam) when a reflective object (e.g. street light, traffic signal, noticeboard and signboard) reflects light.
- Any of the following factors may influence the headlight beam switching timing:
  - How brightly the exterior lights of a vehicle in front or oncoming vehicle illuminate.
  - Movement or direction of a vehicle in front or oncoming vehicle.
  - Only right or left exterior light of a vehicle in front or oncoming vehicle is illuminating.
  - A vehicle in front or oncoming vehicle is a motorcycle.
  - Road conditions (gradient, bends and road surface).
  - The number of occupants and luggage load.

 **NOTE**

- The AHB recognises environmental conditions by sensing a light source ahead of your vehicle. Therefore, you may feel like something is not quite right when the headlight beams are switched automatically.
- The AHB may not detect a light vehicle such as a bicycle.
- The AHB may not detect an ambient brightness precisely. This causes the traffic to be dazzled by high beam or the low beam to be maintained. In such cases, you should switch the headlight beams manually.
  - In bad weather (heavy rain, fog, snow or sandstorm).
  - The windshield is dirty or fogged up.
  - The windshield is cracked or broken.
  - The sensor is deformed or dirty.
- A light, which is similar to the headlights or tail lights, is shining around your vehicle.
- A vehicle in front or oncoming vehicle is driven without lights, the exterior lights are dirty or discoloured, or the direction of the headlight beams is adjusted improperly.
- It becomes dark and bright suddenly and continuously around your vehicle.
- Your vehicle is driven on uneven surfaces.
- Your vehicle is driven on a winding road.
- A reflective object such as a noticeboard or a mirror reflects a light ahead of your vehicle.

 **NOTE**

- When lights of the vehicle in front or headlights of an oncoming vehicle blend into the other lights.
- The rear end of a vehicle in front (such as a container truck) reflect a strong light.
- Your vehicle's headlight is broken or dirty.
- Your vehicle is inclined due to a flat tire or towing.
- The warning display appears.  
(Refer to “System problem warning” on page 5-196.)
- Observe the precautions below to maintain good usage conditions:
  - Do not attempt to disassemble the sensor.
  - Do not affix a sticker or label on the windshield near the sensor.
  - Avoid overload.
  - Do not modify your vehicle.
  - When the windshield is replaced, use the Mitsubishi Motors genuine parts.

**5****To adjust the sensitivity of the sensor**

The sensitivity of the sensor can be temporarily lowering in the following ways.

1. Park your vehicle in a safe place and the operation mode of the power switch is put in OFF.
2. Press the AHB switch more than 15 times within 5 seconds after operation mode is turned on.

## Combination headlights and dimmer switch

### System problem warning

N00593800069

If a problem occurs with the system, the following warning display will appear to the type of the problem.

**5**

#### ■ The AHB deactivation due to fault

If a failure is detected in the system, the following warning display will appear and the AHB will automatically be turned off.

If the warning display remains even after the operation mode of the power switch is put in OFF and then turned back to ON, please contact a certified Mitsubishi EV dealer.

[When the AHB is malfunctioning]



[When the sensor is malfunctioning]



### NOTE

- If the sensor or its surrounding area becomes extremely high temperature when parking the vehicle under a blazing sun, the “AHB SERVICE REQUIRED” warning display may appear. If the message remains even after the temperature of the sensor or its surrounding area has been in range, please contact a certified Mitsubishi EV dealer.

#### ■ Sensor is too hot or cold

If the AHB becomes temporarily unavailable due to the high or low temperature of the sensor, the following warning display will appear.

After the temperature of the sensor has been in range, the system will automatically return to operation.

If the warning display does not disappear after waiting for a while, there is a possibility that the AHB has a malfunction. Contact a certified Mitsubishi EV dealer for inspection of the system.

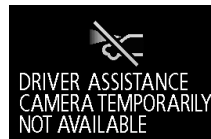

#### ■ Windshield is dirty

If the AHB determines that its performance has been degraded, the warning display will appear.

This can occur when

- Foreign objects, such as dirt, snow or ice, adhere to the windshield of the sensor portion.
- In adverse weather conditions, such as rain, snow, sand storms, etc.
- A front vehicle or an oncoming vehicle is splashing water, snow or dirt.

When the sensor performance returns, the AHB will resume operation.

If the warning display does not disappear after waiting for a while, there is a possibility that the sensor has a malfunction. Contact a certified Mitsubishi EV dealer for inspection of the sensor.





## Welcome light

N00563201319

This function turns on the front side-marker and parking lights for approximately 30 seconds after the UNLOCK button on the F.A.S.T.-Key is pressed when the combination headlights and dimmer switch is in the “OFF” position (if so equipped) or “AUTO” position. The welcome light function will operate only when it is dark outside the vehicle.

### NOTE

- While the welcome light function is operating, perform one of the following operations to cancel the function.
  - Press the LOCK button on the F.A.S.T.-Key.
  - Turn the combination headlights and dimmer switch to the “” or “” position.
  - Put the operation mode in ON.
- It is possible to modify functions as follows:
  - The headlights can be set to come on in the low beam setting.
  - The welcome light function can be deactivated.

### NOTE

For details, consult a certified Mitsubishi EV dealer.  
On vehicles equipped with the Smartphone-link Display Audio (SDA), screen operations can be used to make the adjustment. Refer to the separate owner’s manual for details.

## Coming home light

N00547301240

This function turns on the headlights in the low beam setting for approximately 30 seconds after the operation mode is put in OFF.

1. Turn the combination headlights and dimmer switch to the “OFF” position (if so equipped) or “AUTO” position.
2. Put the operation mode in OFF.
3. Within 60 seconds of putting the operation mode in OFF, pull the turn signal lever toward you.

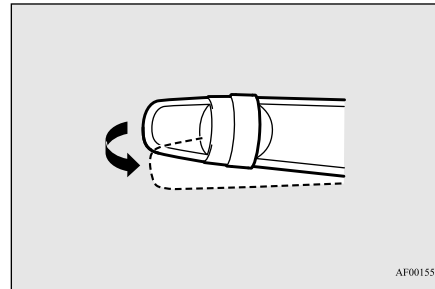



## Combination headlights and dimmer switch

4. The headlights will come on in the low beam setting for approximately 30 seconds. After the headlights go off, the headlights can be turned on again in the low beam setting for approximately 30 seconds by pulling the turn signal lever toward you within 60 seconds of putting the operation mode in OFF. To turn on the headlights again after 60 seconds of putting the operation mode in OFF, repeat the process from step 1.

5

### NOTE

- While the coming home light function is operating, perform one of the following operations to cancel the function.
    - Pull the turn signal lever toward you.
    - Turn the combination headlights and dimmer switch to the “” or “” position or put the operation mode in ON.
    - Put the operation mode in ON.
  - It is possible to modify functions as follows:
    - The time that the headlights remain on can be changed.
    - The coming home light function can be deactivated.
- For details, consult a certified Mitsubishi EV dealer.  
On vehicles equipped with the Smartphone-link Display Audio (SDA), screen operations can be used to make the adjustment. Refer to separate owner’s manual for details.

## Turn signal lever

### Turn signal lever

N00522601620

When changing lanes, or making a gradual turn, hold the lever in the “lane change” position (1). It will return to the neutral position when you let go. Use the full position (2) when making a normal turn. The lever will return to the neutral position when the turn is complete. There may be times when the lever does not return to the neutral position. This usually happens when the steering wheel is turned only slightly. You can easily return the lever by hand.

5

Also, when you move the lever to (1) slightly then release it, the turn signal lights and the indicator light in the instrument cluster will flash three times.

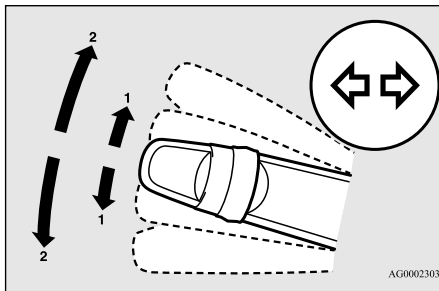

### NOTE

- A light in the instrument panel flashes to show when the front and rear turn signal lights are working properly. If this light flashes faster than usual, check for a burned out turn signal light bulb or malfunctioning connection in the signal. If the panel light does not come on when the lever is moved, check for a blown fuse or a burned out bulb in the panel. Have the system inspected by a certified Mitsubishi EV dealer.
- It is possible to modify functions as follows:
  - Deactivate the turn signal light 3-flash function for lane changes.
  - Adjust the time required to operate the lever for the 3-flash function. See a certified Mitsubishi EV dealer for details.
 For vehicles equipped with the Smartphone-link Display Audio (SDA), adjustments can be made using screen operations. For further details, refer to the separate owner’s manual.
- It is possible to change the tone of a sounding buzzer as the turn signal lights flash. Refer to “Changing the turn-signal sound” on page 5-158.

### Hazard warning flasher switch

N00522701386

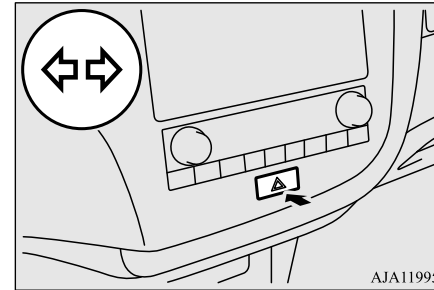

If you press the flasher switch, the front and rear turn signals will flash intermittently, and so will the hazard warning lights. This is an emergency warning system and should not be used when the vehicle is in motion, except for emergencies.

If you need to leave your vehicle, the flashers will keep working after the operation mode is put in OFF.

### NOTE

- If the flashers are used for several hours, the 12 V starter battery will run down. This could make it difficult or impossible to restart your vehicle.

ECO mode switch

**ECO mode switch**

N00579300116

ECO mode is an eco-driving support system which automatically controls the Plug-in Hybrid EV System and air conditioning system to improve fuel efficiency.

When ECO mode is active, your vehicle will slowly accelerate even if pressing the accelerator pedal.

Refer to “Dual-zone automatic climate control air conditioner” on page 7-4.

The ECO mode starts working by pressing the ECO mode switch when the operation mode is in ON.

Push the switch again and the ECO mode will cancel.

While the ECO mode is working, an ECO mode indicator will be turned on.

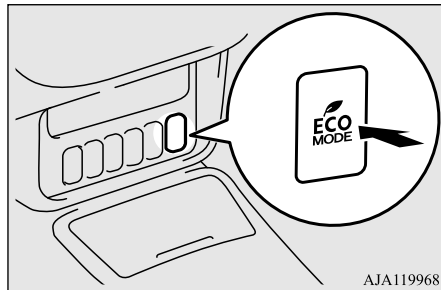

AJA119968

**NOTE**

- The ECO mode becomes OFF when you put the operation mode in ON.
- Even if the ECO mode is operating, you can select normal operation of the air conditioner.

For further information, please contact a certified Mitsubishi EV dealer.

On vehicles equipped with the Smartphone-link Display Audio (SDA), it is possible to change the setting by means of screen operations.

Refer to the separate owner’s manual for details.

**Front fog light switch**

N00522801505

The front fog lights illuminate only when the headlights are on low beam.

Turning the knob in the direction of the “ON” position turns on the front fog lights as well as the indicator in the instrument cluster. To turn them off, turn the knob in the direction of the “OFF” position.

The knob will return to the neutral position when it is released.

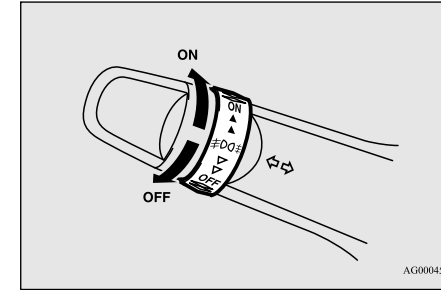

AG0004596

5

**NOTE**

- If the headlights are switched to high beam, the front fog lights will go out; they will illuminate again when the headlights are switched back to low beam.
- If the light switch is rotated to the “OFF” position (if so equipped) or “” position while the front fog lights are illuminated, they will automatically turn off. They can be turned back on again by rotating the combination headlights and dimmer switch back to “” position, and turning the knob in the direction of the “ON” position.
- Do not use fog lights except in conditions of fog, otherwise excessive light glare may temporarily blind oncoming vehicle drivers.

## Wiper and washer switch

### Wiper and washer switch

N00523001810

#### CAUTION

- If the washer is used in cold weather, the washer fluid sprayed against the glass may freeze, which may hinder visibility. Warm the glass with the defroster before using the washer.

5

### Windshield wipers

#### NOTE

- To ensure a clear rearward view, the rear window wiper will automatically perform several continuous operations if the selector lever is put in the “R” position while the windshield wipers are operating. Refer to “Rear window wiper and washer” on page 5-203.

The windshield wipers can be operated with the operation mode is in ON or ACC.

If the blades are frozen to the windshield or rear window, do not operate the wipers until the ice has melted and the blades are freed, otherwise the wiper motor may be damaged.

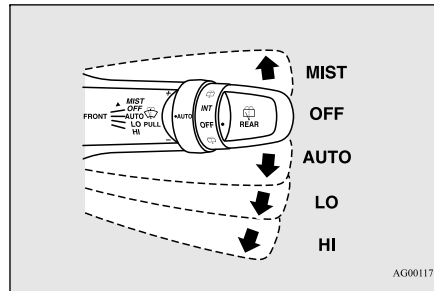

- MIST- Misting function  
The wipers will operate once.
- OFF- Off
- AUTO- Auto-wiper control  
Rain sensor  
The wipers will automatically operate depending on the degree of wetness on the windshield.
- LO- Slow
- HI- Fast

### Rain sensor

Can only be used when the operation mode is in ON.

If the lever is put in the “AUTO” position, the rain sensor (A) will detect the extent of rain (or snow, other moisture, dust, etc.) and the wipers will operate automatically.

Keep the lever in the “OFF” position if the windshield is dirty and the weather is dry.

Wiper operation under these conditions can scratch the windshield and damage the wipers.

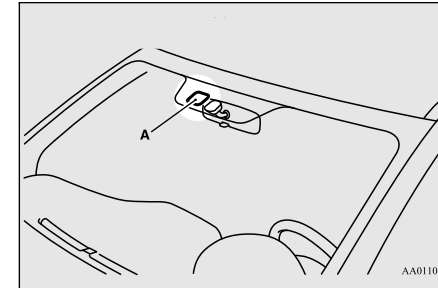

#### CAUTION

- With the operation mode in ON and the lever in the “AUTO” position, the wipers may automatically operate in the situations described below.
- When cleaning the outside surface of the windshield, if you touch the rain sensor.



## Wiper and washer switch

### ⚠ CAUTION

- When cleaning the outside surface of the windshield, if you wipe with a cloth the rain sensor.
- When using an automatic car wash.
- A physical shock is applied to the windshield.
- A physical shock is applied to the rain sensor.

If your hands get trapped, you could suffer injuries or the wipers could malfunction. Be sure to put the operation mode in OFF, or move the lever to the “OFF” position to deactivate the rain sensor.

### 📖 NOTE

- To protect the rubber parts of the wipers, this operation of the wipers does not take place even if the lever is put in the “AUTO” position when the vehicle is stationary and the ambient temperature is approximately 32 °F (0 °C) or lower.
- Do not cover the sensor by affixing a sticker or label to the windshield. Also, do not put any water-repellent coating on the windshield. The rain sensor would not be able to detect the extent of rain, and the wipers might stop working normally.
- In the following cases, the rain sensor may be malfunctioning. Have the vehicle checked at a certified Mitsubishi EV dealer.

### 📖 NOTE

- When the wipers operate at a constant interval despite changes in the extent of rain.
- When the wipers do not operate even though it is raining.
- The wipers may automatically operate when things such as insects or foreign objects are affixed to the windshield on top of the rain sensor or when the windshield is frozen. Objects affixed to the windshield will stop the wipers when the wipers cannot remove them. To operate the wipers again, move the lever to the “LO” or “HI” position. Also, the wipers may operate automatically due to strong direct sunlight or electromagnetic wave. To stop the wipers, move the lever to the “OFF” position.
- Contact a certified Mitsubishi EV dealer when replacing the windshield glass.

### To adjust the sensitivity of the rain sensor

With the lever in the “AUTO” (rain sensor) position, it is possible to adjust the sensitivity of the rain sensor by turning the knob (B).

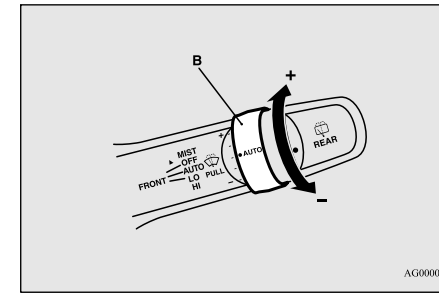

5

- “+”- Higher sensitivity to rain
- “-”- Lower sensitivity to rain

### 📖 NOTE

- Automatic wiper operation (rain sensitive) can be changed to intermittent operation, either vehicle speed sensitive or not vehicle speed sensitive. For further information, please contact a certified Mitsubishi EV dealer. On vehicles equipped with the Smartphone-link Display Audio (SDA), screen operations can be used to make the adjustment. Refer to the separate owner’s manual for details.

## Wiper and washer switch

### Misting function

Move the lever in the direction of the arrow and release, to operate the wipers once.

Use this function when you are driving in mist or drizzle.

The wipers will operate once if the lever is raised to the “MIST” position and released when the operation mode is in ON or ACC. The wipers will continue to operate while the lever is held in the “MIST” position.

5

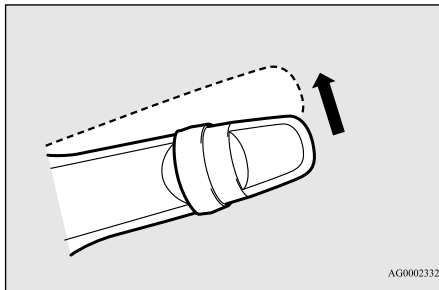

The wipers will operate once if the lever is moved to the “AUTO” position and the knob (C) is turned in the “+” direction when the operation mode is in ON.

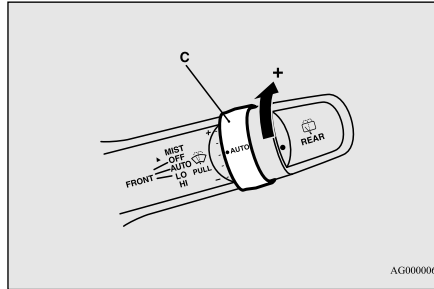

### Windshield washer

The windshield washer can be operated with the operation mode in ON or ACC.

The washer fluid will be sprayed onto the windshield by pulling the lever toward you.

When the wipers are not in operation or in intermittent operation, by pulling the lever toward you, the wipers will operate several times while the washer fluid is being sprayed.

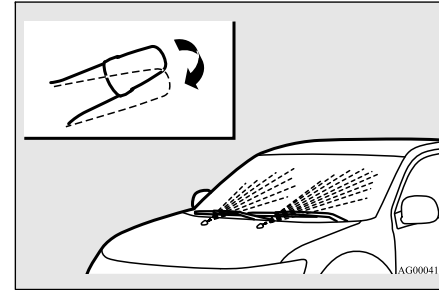

### NOTE

- It is possible to modify functions as follows:
  - Intelligent washer can be activated. Refer to “Intelligent washer” on page 5-203.
  - The wipers can be set to operate again after approximately 6 seconds.

These functions are not activated when the vehicle is shipped from the factory.

To activate or deactivate these functions, please contact a certified Mitsubishi EV dealer.

On vehicles equipped with the Smartphone-link Display Audio (SDA), screen operations can be used to make the adjustment.

Refer to the separate owner's manual for details.

## Wiper and washer switch

### Intelligent washer

By releasing the lever soon after pulling it toward you, the washer fluid will be sprayed several times while the wipers are operating several times.

Intelligent washer will stop operating with any operation of the lever.

### Rear window wiper and washer

N00523201506

The rear window wiper and washer can be operated when the operation mode is in ON or ACC.

Turn the knob to operate the rear window wiper.

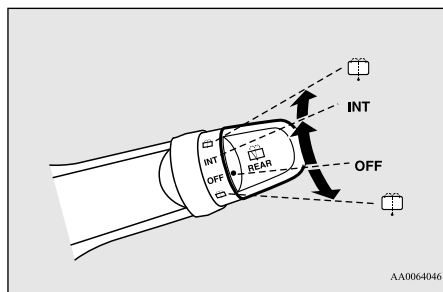

OFF- Off

INT- The wiper operates continuously for several seconds then operates intermittently at intervals of approximately 8 seconds.

 Washer fluid will be sprayed onto the rear window glass while the knob is turned fully in either direction.

When the washer fluid is sprayed, the wiper will automatically operate 2 or 3 times.

### NOTE

- The rear window wiper will automatically perform several continuous operations if the selector lever is put in the “R” position while the windshield wipers or the rear window wiper is operating.(automatic operation mode)

After the automatic operation, the rear window wiper will stop operating if the knob is in the “OFF” position. If the knob is in the “INT” position, the rear window wiper will return to the intermittent operation.

It is possible to set the rear window wiper to perform the automatic operation only if the selector lever is put in the “R” position while the rear window wiper is operating with the knob in the “INT” position.

See a certified Mitsubishi EV dealer for details.

### NOTE

- If the knob is in the “OFF” position, turn the knob to the “INT” position twice quickly to operate the rear window wiper continuously. (continuous operation mode)  
Turn the knob to the “OFF” position to stop the rear window wiper continuous operation.
- The wiper intermittent operation time can be adjusted.  
See a certified Mitsubishi EV dealer for details.  
For vehicles equipped with the Smartphone-link Display Audio (SDA), adjustments can be made using screen operations. For further details, refer to the separate owner’s manual.
- The washer fluid reservoir is located in the engine compartment.  
Check the fluid level regularly and refill if necessary. (Refer to “Washer fluid” on page 9-10.)

5

### Precautions to observe when using wipers and washers

N00523501310

### CAUTION

- If the washer is used in cold weather, the washer fluid sprayed onto the glass might freeze, blocking your view. Heat the glass with the defroster before using the washer.

## Wiper deicer switch (if so equipped)

5

**NOTE**

- Do not use the wipers when the windshield is dry. This could scratch the glass and wear the wiper blades prematurely.
- Before using the wipers in cold weather, check to be sure that the wiper blades are not frozen to the windshield or rear window. Using the wipers while the blades are frozen could cause the wiper motor to burn out.
- If the moving wipers become blocked part-way through a sweep by ice or other deposits on the glass, the wipers may temporarily stop operating to prevent the motor from overheating. In this case, park the vehicle in a safe place, put the operation mode in OFF, and then remove the ice or other deposits. Because the wipers will start operating again after the wiper motor cools down, check that the wipers operate before using them.
- Avoid using the washer for more than 20 seconds at a time. Do not operate the washer when the washer fluid reservoir is empty or the pump may fail.
- During cold weather, add a recommended washer solution that will not freeze in the washer fluid reservoir. Otherwise the washer may not work or may be damaged.
- Replace the wiper blades when they are worn. Use the proper size replacement blades. For further information, please contact a certified Mitsubishi EV dealer.

**Wiper deicer switch (if so equipped)**

N00584400030

The electric rear window defogger switch can be operated when the Plug-in Hybrid EV System is running.

When the front wipers have frozen to the windshield at the parked positions, turning on this switch will heat the windshield to make the wipers operable. Press the electric rear window defogger switch and the deicer will operate.

**NOTE**

- The wiper deicer is activated/deactivated, depending on the operation of the rear window defogger. Refer to “Electric rear window defogger switch” on page 5-204.

**Electric rear window defogger switch**

N00523701585

The rear window defogger can be used when the Plug-in Hybrid EV System is running.

The indicator light (A) will come on when you press the electric rear window defogger switch. Electric current will flow through the heating wires on the rear window to help clear away moisture or frost.

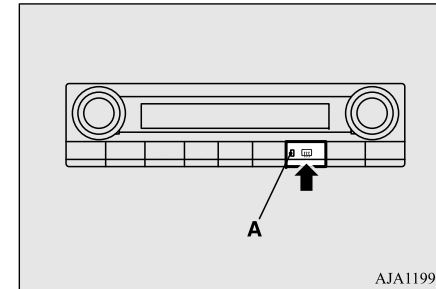

AJA119913

After approximately 15 to 20 minutes of operation, the system will shut off automatically.

To switch the defogger OFF before 15 to 20 minutes have passed, press the switch again. The indicator light will go out and the defogger will turn off.

If you need the defogger for more than 15 to 20 minutes, press the switch again. This will add 15 to 20 more minutes.

## Heated steering wheel switch (if so equipped)

### CAUTION

- The rear window defogger is not designed to melt snow. Remove any snow manually before using the rear window defogger.
- Use the rear window defogger only after the Plug-in Hybrid EV System has started and is running. Be sure to turn the defogger switch off immediately after the window is clear to save on 12 V starter battery power.
- Do not place stickers, tape, or other items that are attached with adhesive over the grid wires on the rear window.
- When cleaning the inside rear window, use a soft cloth and wipe lightly over the grid wires.

### NOTE

- Mist can also be removed from the outside rearview mirrors when the rear window defogger switch is pressed. (Refer to “Heated outside rearview mirror” on page 5-55.)
- On vehicles equipped with the wiper deicer, when the rear window defogger switch is pushed, the windshield becomes warm and the wipers become operable. (Refer to “Wiper deicer switch” on page 5-204.)

### NOTE

- It is possible to change the setting to make the rear window defogger operate automatically when ambient temperature becomes low while the engine is running, even if you do not push the rear window defogger switch.  
It operates automatically only once after putting the operation mode in ON.  
If you choose this setting, the heated outside rearview mirror and wiper deicer (if so equipped) will also operate automatically at the same time.  
For further information, please contact a certified Mitsubishi EV dealer.  
On vehicles equipped with the Smartphone-link Display Audio (SDA), screen operations can be used to make the adjustment.  
Refer to the separate owner’s manual for details.

### Heated steering wheel switch (if so equipped)

N00589100074

The heated steering wheel contains internal heaters in the rim. Heating areas are shown in the illustration.

5

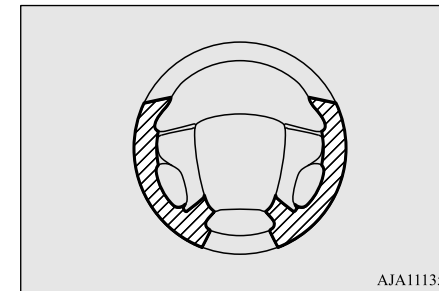

AJA111353

: Heating area

The heated steering wheel can be operated when the operation mode of the power switch is in ON.

## Horn switch

To turn on the heated steering wheel, push the heated steering wheel switch. The heated steering wheel will operate for approximately 30 minutes and then it will automatically turn off.

The indicator light (A) will illuminate while the heated steering wheel is operating.

5

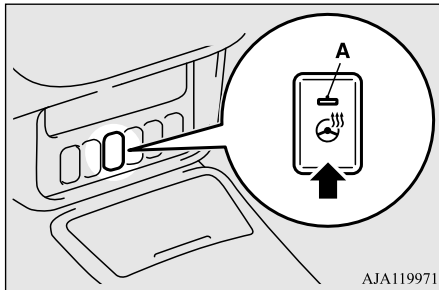

## WARNING

- Persons who are unable to feel temperature change or skin pain due to age, illness, injury, medication, fatigue or other physical conditions or who have sensitive skin may suffer burns when using the heated steering wheel. To reduce the risk of burns, people with such conditions must use care when using the heated steering wheel.

## CAUTION

- If water or any other liquid is spilled on the steering wheel, allow it to dry thoroughly before attempting to use the heated steering wheel. Turn the heated steering wheel off immediately if it appears to be malfunctioning during use.
- Also be aware that using the heated steering wheel with the ready indicator off may run the 12 V starter battery down.

## Horn switch

N00523801238

To honk the horn, press around the “” mark on the steering wheel.

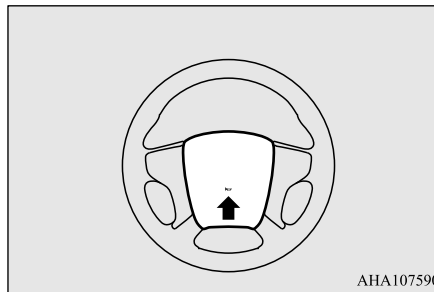

## Link System

N00563701183

The Link System takes control of the devices connected via the USB input terminal or the Bluetooth® device; the system allows the connected device to be operated by using the switches in the vehicle or voice commands. For details on how to operate, refer to “USB input terminal” on page 5-207 and the separate owner’s manual.

Bluetooth® is a registered trademark of BLUETOOTH SIG, INC.

## USB input terminal

N00566701272

You can connect your USB memory device or iPod\* to play music files stored in the USB memory device or iPod.

\*: "iPod" is a registered trademark of Apple Inc. in the United States and other countries.

This section explains how to connect and remove a USB memory device or iPod.

Refer to the separate owner's manual for details on the types of connectable devices and supported files, and how to play music files.

## USB input terminal locations

The USB input terminal (A) is located in the illustrated positions.

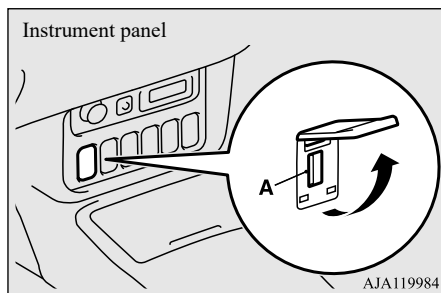

Back of floor console box (if so equipped)

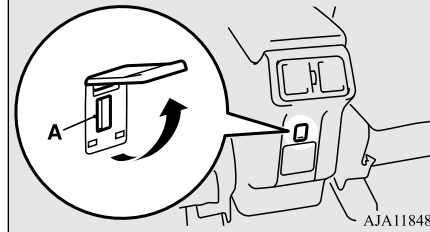

## How to connect a USB memory device

N00566801231

1. Park your vehicle in a safe place and put the operation mode of the power switch in OFF.
2. Open the USB input terminal cover.

## USB input terminal

3. Connect a commercially available USB connector cable (A) to the USB memory device (B).

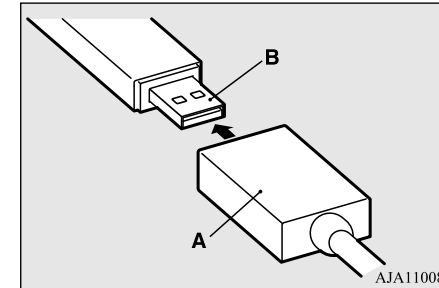

5

4. Connect the USB connector cable to the USB input terminal.

## NOTE

- Do not connect the USB memory device to the USB input terminal directly. The USB memory device may be damaged.

5. To remove the USB connector cable, put the operation mode of the power switch in OFF first and perform the installation steps in reverse.

## Sun visors

### How to connect an iPod

N00566901261

1. Park your vehicle in a safe place and put the operation mode of the power switch in OFF.
2. Open the USB input terminal cover.
3. Connect the connector cable to the iPod.

5

#### NOTE

- Use a genuine connector cable from Apple Inc.

4. Connect the connector cable to the USB input terminal.
5. To remove the connector cable, put the operation mode of the power switch in OFF first and perform the installation steps in reverse.

### Sun visors

N00524601448

Pull the sun visor downward (1) to reduce front glare while driving. To reduce side glare, turn the visor to the side (2).

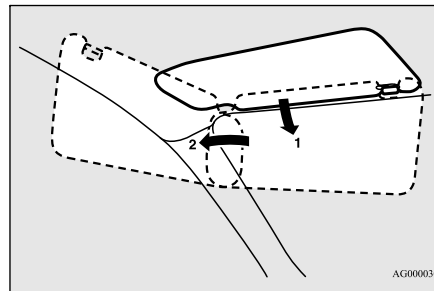

### Vanity mirror

A vanity mirror is fitted to the back of the sun visor.

Operating the lid of the vanity mirror will automatically turn on the mirror light (A).

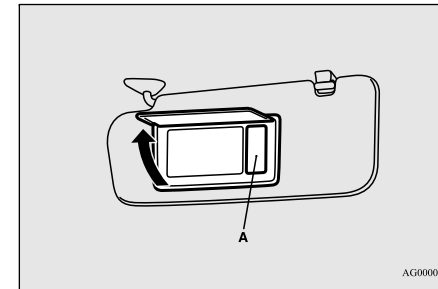

#### CAUTION

- If the lid of vanity mirror with light is kept open for prolonged periods of time, the 12 V starter battery will be discharged.



## 12 V power outlets

### Ticket holder

The holder (B) is located on the back of the sun visor.

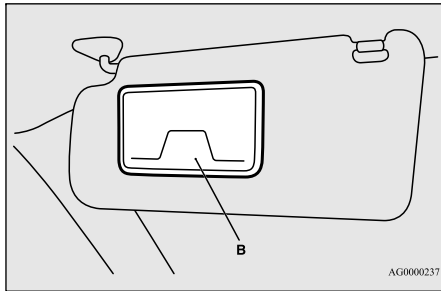

### CAUTION

- Do not leave plastic cards in the ticket holder. Because the inside of the vehicle will become hot if the vehicle is parked in strong sunlight, the cards could deform or crack.

### 12 V power outlets

N00525001755

### CAUTION

- Be sure to use a “plug-in” type accessory operating at 12 V and at 120 W or less. When using the two sockets at the same time, make sure the total power consumption of the electrical accessories does not exceed 120 W at 12 V.
- Also be aware that using electronic equipment with the ready indicator off may run the 12 V starter battery down.
- When the power outlet is not in use, be sure to close the power outlet cover or replace the cap. This will prevent the power outlet from becoming clogged and short circuiting.

To use a “plug-in” type accessory, open the cover or remove the cap, and insert the plug in the power outlet.

### Type 1

Accessories can be operated when the operation mode of the power switch is in ON or ACC.

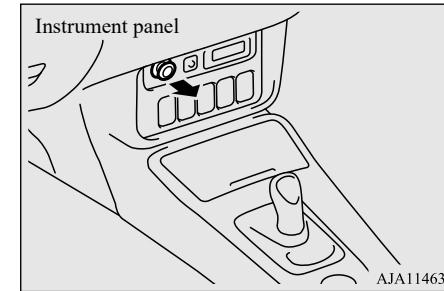

5

## USB port (for charging) (if so equipped)

### Type 2

Accessories can be operated in all operation modes of the power switch.

5

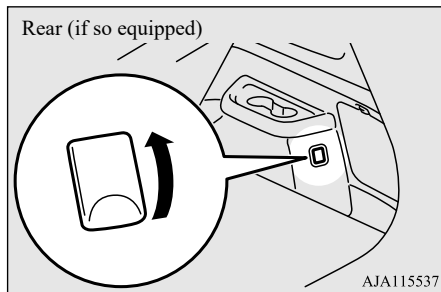

### USB port (for charging) (if so equipped)

N00596400037

The USB port (for charging) can be used as a power source of the USB appliances when the operation mode of the power switch is put in ON or ACC.

There are two USB ports (for charging) located on the back of the floor console box. When using the USB port (for charging), open the lid and connect the USB connector cable to it.

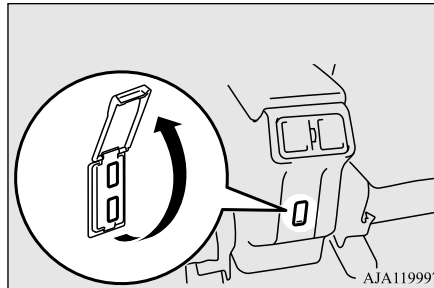

### CAUTION

- When the USB port (for charging) is not in use, be sure to close the lid, because the USB port (for charging) might be short-circuited by clogging foreign materials and the connected devices and the USB port (for charging) might be damaged.

### CAUTION

- Insert the USB connector cable in the USB port (for charging) firmly. If the USB connector cable does not insert in it firmly, it may become extremely hot and the fuses may blow.
- Be sure that the power consumption does not exceed 10.5 W {The peak outlet current or voltage of the USB port (for charging) is DC 5 V-2.1 A}. The connected devices or the USB port (for charging) may be damaged.
- Do not use the reversible USB connector cable that the USB connector board is located in the centre. The USB port (for charging) might be damaged.
- Long use of the electric appliance without running the engine may run down the battery.

### NOTE

- The USB ports (for charging) can be used only as a power source. These are not connected to the audio devices of the vehicles.
- Do not charge many mobile devices together by using a multi-plug adapter of the USB port (for charging).
- If water or spill beverages has splashed on the USB ports (for charging), stop using it and have the vehicle checked by a certified Mitsubishi EV dealer.

## 120 V AC power supplies (if so equipped)

N00591100071

120 V AC power supply can be used as a power source of household appliances when the ready indicator illuminates.

### CAUTION

- Be sure to use a “plug-in” type accessory operating at 120 V and at 1500 W or less. When using more than one power outlet at the same time, make sure the total power consumption of the electrical appliances does not exceed 1500 W at 120 V.

Back of floor console box

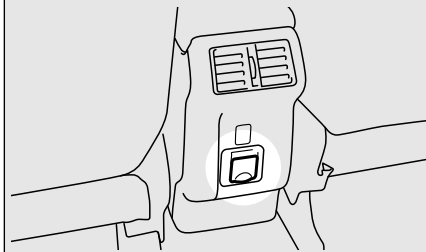

Right side of cargo area

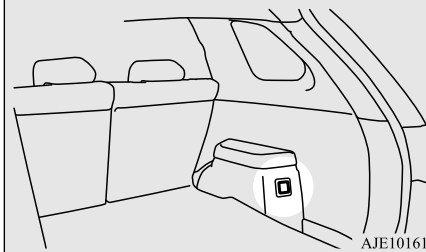

AJE101619

## 120 V AC power supplies (if so equipped)

### To use

1. Press the 120 V AC power supply switch. The indicator light (A) will come on and power supply system is ready for use. To cancel power supply, press the switch again and the indicator light will go off.

5

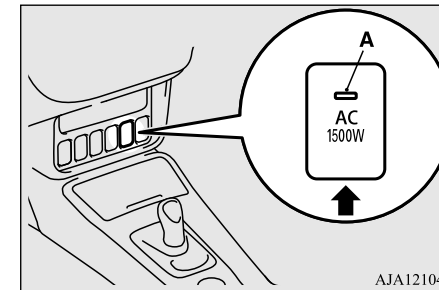

AJA121040

2. Open the lid (B).

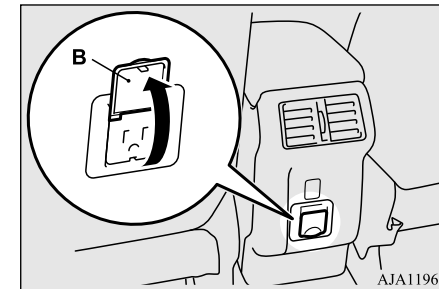

AJA119678

120 V AC power supplies (if so equipped)

5

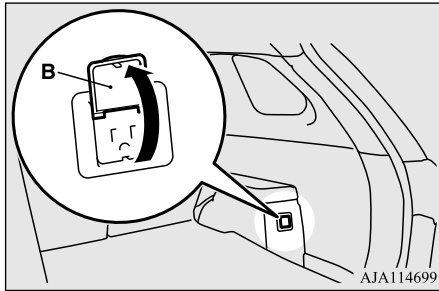

3. Insert the plug in the power outlet firmly. Make sure the plug is connected correctly.
4. Disconnect the plug and close the lid after using the electrical appliance.

**⚠ WARNING**

- Never use the 120 V AC power supply to charge an electric vehicle or a plug-in hybrid vehicle. Also, never connect the 120 V AC power supply to a household powerline or a distribution panel. This may lead to electric shock or a malfunction.
- Do not connect or disconnect the plug with a wet hand. Doing so can cause an electric shock.
- Never pull the cable to remove the plug. Pull straight with holding the plug of an electrical appliance.
- Do not disassemble or modify the 120 V AC power supply.

**⚠ WARNING**

- When using electrical appliance while driving, make sure that it is firmly secured. Flying objects entering the passenger compartment during sudden braking or sharp turning could result in a serious accident and/or injury. Refer to “Luggage hooks” on page 5-229.
- Do not use an electrical appliance while emits steam while the windows are closed. Lack of visibility due to steam could lead to an accident. Also, doing so may damage other electrical components.
- While using the 120 V AC power supply, even if the engine is not running, the engine may automatically start later depending on the condition of the Plug-in Hybrid EV system and/or the main drive lithium-ion battery.
- Before using the 120 V AC power supply while the vehicle is stationary, to prevent the vehicle from moving abruptly, apply the parking brake firmly and press the electrical parking switch and make sure that the select position indicator on the multi-information displays “P” (PARK). Also, to avoid activating the selector lever, do not place a power cord on or near the lever.

**⚠ WARNING**

- Never use the 120 V AC power supply in a closed or poorly ventilated area, such as in a garage, or an area surrounded by snow banks. Carbon monoxide gas, which is odorless and extremely poisonous, could build up and cause serious injury or death.
- Do not park your vehicle in areas where combustible materials such as dry grass or leaves can come in contact with a hot exhaust, since a fire could occur.
- When using the 120 V AC power supply while it is raining or snowing, do not leave the door or liftgate open. Wetting the 120 V AC power supply may cause overheating resulting in a fire and/or electrical shock.
- Never use a multi-plug adapter or conversion adapter. Using them may cause overheating resulting in fire.
- If you use an electrical appliance that emits light, your visibility at night may be affected which could impede safe driving.
- Do not spill a beverage on the 120 V AC power supply. This may cause overheating resulting in a fire and/or electrical shock.
- Do not let children touch the 120 V AC power supply.
- The cooling fan in the engine compartment may automatically operate when using the 120 V AC power supply. Keep your hands and clothes away from the cooling fan.

## 120 V AC power supplies (if so equipped)

**⚠ WARNING**

- Never use the 120 V AC power supply when lightning or thunder is observed or expected.
- Never use the 120 V AC power supply for electromedical apparatus.

**⚠ CAUTION**

- When the 120 V AC power supply is not in use, be sure to cancel power supply by pressing the 120 V AC power supply switch, disconnect the plug and close the lid. This will prevent the 120 V AC power supply from becoming clogged and short circuiting.
- Do not stand behind the exhaust pipe as the engine may automatically start depending on the condition. Heat from the exhaust could lead to burns.
- Make sure that the plug is inserted all the way into the 120 V AC power supply before using an electrical appliance.
- Do not use an electrical appliance in the vehicle which emits heat such as a heater. Heat damage to interior parts could result.
- Do not connect a malfunctioning electrical appliance to the 120 V AC power supply. Doing so could damage the 120 V AC power supply.

**📖 NOTE**

- 12 V power outlets and 120 V AC power supplies can be used simultaneously. Refer to “12 V power outlets” on page 5-209.
- If the plug of the electrical appliance was loose or wobbled when inserted in the outlet, replace the 120 V AC power supply by a certified Mitsubishi EV dealer.
- Never leave the vehicle, perform refueling or washing the vehicle while using the 120 V AC power supply.
- You may hear operating sounds such as sounds from the cooling fan near luggage area when using the 120 V AC power supply. This is normal.
- Never use electrical appliance which is vulnerable to vibration or heat in the cabin. When exposed to the strong direct sunlight, the cabin will become extremely hot. It could cause product failure.
- Do not use the 120 V AC power supply with the vehicle covered by a car cover.
- When closing the window, door or liftgate, be careful not to trap the power supply cord of the electrical appliance.
- 120 V AC power supply cannot be used in the following cases.
  - When Plug-in Hybrid EV System warning light is illuminated.
  - When the main drive lithium-ion battery level display indicates 0.
  - When the “PROPULSION POWER IS REDUCED” warning display appears.

**📖 NOTE**

- Electrical appliance may not operate normally or electricity supply stops under the following conditions. You may hear an operation noise. This is normal.
  - When the power consumption of the electrical appliance exceeds 1500 W.
  - When the vehicle interior temperature is too hot or too cold.
- When the 120 V AC power supply cannot be used or is not returned to operation automatically after stopping electricity supply, follow the procedures below.
  1. Disconnect the plug of electrical appliance.
  2. Confirm the remaining quantity of the main drive lithium-ion battery. When it is low, charge the main drive lithium-ion battery by using the battery charge mode, etc.
    - “Battery charge mode” P.5-69
    - “Normal charging (charging method with rated AC 120 V outlet)” P.3-20
    - “Quick charging (charging method with quick charger)” P. 3-32
  3. Confirm the ready indicator illuminates. If not, start the Plug-in Hybrid EV System.
  4. When the vehicle interior temperature is too hot or too cold, adjust it appropriately by using air conditioner.
  5. Press the 120 V AC power supply switch to turn on.

## HomeLink® Wireless Control System (if so equipped)

5

### NOTE

6. Confirm the indicator light on 120 V AC power supply switch comes on and insert the plug in the power outlet.

If the 120 V AC power supply cannot be used after performing the above steps, have your vehicle checked by a certified Mitsubishi EV dealer.

- The following electrical appliance may not operate normally even if the power consumption is less than 1500 W. Also be aware that electric power which can be used will vary depending on the main drive lithium-ion battery condition.
  - Electrical appliance to which large current flows momentarily
  - Electrical appliance which gauges precise data
  - Electrical appliance which does not operate normally when it is not placed horizontally
  - Electrical appliance which needs extremely stable operation
  - Electrical appliance with a timer function, which needs the consecutive output
- AC power output may be shut off and the electrical appliance may be turned off accordingly depending on the main drive lithium-ion battery condition even if the battery level display does not indicate 0.
- Use of electrical appliance could cause radio or television noise.

### NOTE

- The voltage of the 120 V AC power supply cannot be correctly gauged with a commercially available tester. Consult a certified Mitsubishi EV dealer when you need measurement of the voltage.
- Also refer to the instruction manual and label accompanying the electrical appliance.
- When the remaining power in the main drive lithium-ion battery is low, the engine starts and charges the main drive lithium-ion battery automatically. Be careful not to run out of fuel since it will be consumed when the engine starts.

## HomeLink® Wireless Control System (if so equipped)

N00554301082

HomeLink® and the HomeLink® house icon are registered trademarks of Gentex Corporation.

HomeLink® provides a convenient way to replace up to 3 hand-held radio-frequency (RF) transmitters used to activate devices such as gate operators, garage door openers, entry door locks, security systems, even home lighting. Additional HomeLink® information can be found at [www.homelink.com](http://www.homelink.com), [www.youtube.com/HomeLinkGentex](http://www.youtube.com/HomeLinkGentex), or by

calling the toll-free HomeLink®-Hotline at 1-800-355-3515.

### WARNING

- Do not use HomeLink® with any garage door opener that lacks safety stop and reverse features as required by U.S. Federal Regulations. A garage door opener which cannot detect an object in the path of a closing garage door and then automatically stop and reverse, does not meet current U.S. Federal Regulations. Using a garage door opener without these features increases the risk of serious injury or death.
- During programming, your garage door or gate may open or close. Make sure that people and objects are clear of the garage door or gate that you are programming.

### NOTE

- Once HomeLink® is programmed, retain the original transmitter for future programming procedures (for example, new vehicle purchases). Upon sale of the vehicle, the programmed HomeLink® buttons should be erased for security purposes. Refer to “Cleaning the programmed information” on page 5-218.

## HomeLink® Wireless Control System (if so equipped)

### NOTE

- You can program a maximum of 3 devices. To change or replace any of the 3 devices after it has been initially programmed, you must first erase the current settings. See “Cleaning the programmed information” on page 5-218 or “Reprogramming a single HomeLink® button” on page 5-219.

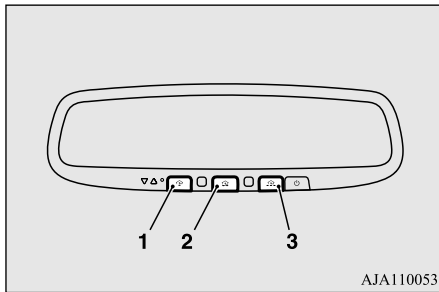

- 1- HomeLink® button 1
- 2- HomeLink® button 2
- 3- HomeLink® button 3

### Before programming Home-Link®

N00584600029

- Some garage door openers manufactured after 1995 have “rolling code protection”. To program a garage door opener equipped with “rolling code protection”; you will need to access the garage door opener motor to press the motor’s “Learn” or “Smart” buttons. For convenience, use a ladder and another person to assist you.
- It is recommended that a new battery be placed in the hand-held transmitter of the device being programmed to HomeLink® for quicker training and accurate transmission of the radio-frequency signal.

### Programming a new Home-Link®

N00584700059

To program HomeLink® to operate a garage door, gate, or entry door opener, home or office lighting, you need to be at the same location as the device.

1. Press the HomeLink® button that you would like to program. The indicator light (A) will flash orange slowly.

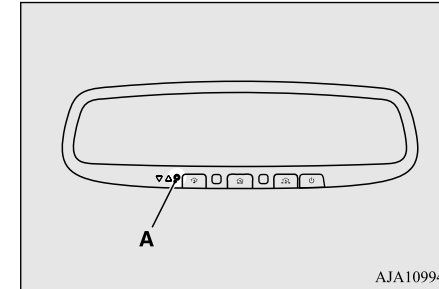

5

### NOTE

- You do not need to continue holding the HomeLink® button.
- If the indicator light does not flash, refer to “Cleaning the programmed information” on page 5-218.

## HomeLink® Wireless Control System (if so equipped)

- Position the end of your hand-held transmitter (B) 1 to 3 inches (2 to 8 cm) away from the HomeLink® button while keeping the indicator light in view.

**5**

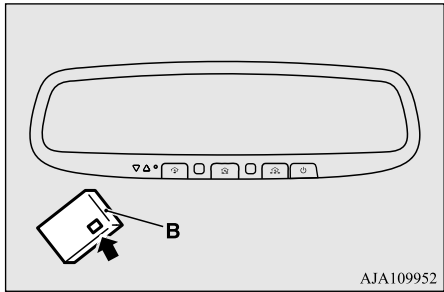

### NOTE

- Some hand-held transmitters may actually train better from a distance of 6 to 12 inches (15 to 30 cm). Keep this in mind if you have difficulty with the programming process.

- Press and hold the hand-held transmitter button while watching the indicator light (A). Continue pressing the button until the indicator light (A) changes from slowly flashing orange to either rapidly flashing green (rolling code) or continuously lit green (fixed code). Now you may release the hand-held transmitter button.

### NOTE

- Some devices may require you to replace this “Programming a new HomeLink®” step 3 with procedures noted in the “Gate operator / Canadian programming” section. If the indicator light does not change to rapidly flashing green or continuously lit green after performing these steps, contact HomeLink® at [www.homelink.com](http://www.homelink.com)

- Press the HomeLink® button that was just programmed and observe the indicator light.

- If the indicator light continuously illuminates green, programming is complete and your device should operate when the HomeLink® button is pressed and released.
- If the indicator light rapidly flashes green, firmly press, hold for 2 seconds and release the programmed HomeLink® button. Repeat the “press/hold/release” sequence a second time, and, depending on the brand of the garage door opener (or other rolling code equipped device), repeat this sequence a third time to complete the programming process. At this point if your device operates, programming is complete.

- If the device does not operate, continue with “Programming a new HomeLink®” steps 5 to 7 to complete the programming of a rolling code equipped device.

- At the garage door opener receiver (motor-head unit) in the garage, locate the “Learn” or “Smart” button. This can usually be found where the hanging antenna wire is attached to the motor-head unit (see the garage door opener manual to identify the “Learn” button.)

- Firmly press and release the “Learn” or “Smart” button. (The name and color of the button may vary by manufacturer.) There are typically 30 seconds to initiate step 7.

- Return to the vehicle and firmly press, hold for 2 seconds and release the programmed HomeLink® button. Repeat the “press/hold/release” sequence a second time, and, depending on the brand of the garage door opener (or other rolling code equipped device), repeat this sequence a third time to complete the programming process.

HomeLink® should now activate your rolling code equipped device.



## HomeLink® Wireless Control System (if so equipped)

### NOTE

- In the event that there are still programming difficulties or questions, additional HomeLink® information and programming videos can be found online at [www.homelink.com](http://www.homelink.com), [www.youtube.com/HomeLinkGentex](http://www.youtube.com/HomeLinkGentex), or by calling the HomeLink® Hotline.

### Gate operator/Canadian programming

N00584800021

Canadian radio-frequency laws require transmitter signals to “time-out” (or quit) after several seconds of transmission - which may not be long enough for HomeLink® to pick up the signal during programming. Similar to this Canadian law, some U.S. gate operators are designed to “time-out” in the same manner.

The indicator LED on the hand-held transmitter will go off when the device times out indicating that it has finished transmitting.

If you live in Canada or you are having difficulties programming a gate operator or garage door opener by using the “Programming” procedures, replace “Programming a new HomeLink®” step 3 with the following:

### NOTE

- If programming a garage door opener or gate operator, it is advised to unplug the device during the “cycling” process to prevent possible overheating.

3. Press and release - every 2 seconds (“cycle”) your hand-held transmitter until the HomeLink® indicator light changes from slowly flashing orange to either rapidly flashing green (rolling code) or continuously lit green (fixed code). Now you may release the hand-held transmitter button.

Proceed with “Programming a new HomeLink®” step 4 to complete.

### Additional steps for programming a door system with feedback

N00584900022

The HomeLink® has the capability of receiving garage door status from compatible garage door opener systems. Check your garage door opener manual for the available feature and HomeLink® compatibility. Also for a listing of compatible systems contact HomeLink® at: [www.homelink.com](http://www.homelink.com)

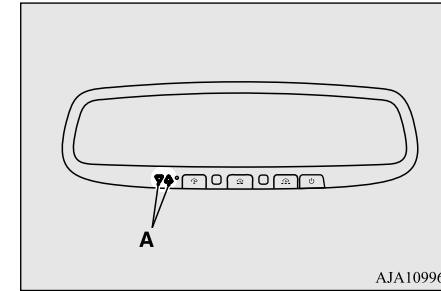

5

1. Within 5 seconds after successfully programming the garage door opener (refer to “Programming a new HomeLink®” section), both garage door operation indicators (A) will flash rapidly green indicating that the garage door feedback has been enabled.

If the indicators do not flash, perform steps 2 and 3 while pressing the HomeLink® button up to the first 10 times after successful programming.

2. Press and release the programmed HomeLink® button to activate the door. You now have 1 minute in which to complete step 3.

**5**

**HomeLink® Wireless Control System (if so equipped)**

3. Once the door has stopped, press and release the “Learn” or “Smart” button on the garage door opener (refer to your garage door opener owner’s manual for the location of the “Learn” button). Both the HomeLink® garage door operation indicators will flash rapidly green upon successful synchronization with the door opener (within 5 seconds).

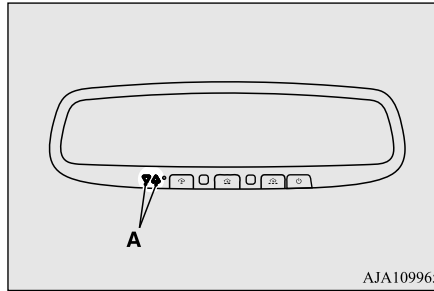

**Operating HomeLink®**

N0058500020

To operate, simply press and release the programmed HomeLink® button. Activation will now occur for the trained device (i.e. garage door opener, gate operator, security system, entry door lock, home/office lighting, etc.). For convenience, the hand-held transmitter of the device may also be used at any time.

**Garage door feedback**

N00585200022

The HomeLink® has the capability of receiving garage door status from compatible garage door opener systems. Refer to “Additional steps for programming a door system with feedback” on page 5-217. Garage door status is then displayed with indicators (A).

The indicators will illuminate/blink in response to the following conditions:

▼ ▲: Blinking    ▼ ▲: Illuminates

Garage door opener closing	▼ ▲ (orange)
Garage door opener closed	▼ (green)
Out of range	▼ ▲ (red)
Garage door opener opening	▼ ▲ (orange)
Garage door opener opened	▲ (green)
Out of range	▼ ▲ (red)

The HomeLink® has the capability of listening to these messages at a range up to 820.2 feet (250 m) (open line of sight), but range may be reduced by obstacles such as houses or trees. You may have to slow your vehicle speed to receive the CLOSED or OPENED message feedback from the garage door opener. If the unit is out of range before receiving either the UP or DOWN message from the door opener, both the UP and DOWN indicators will flash red followed by a continuous lit orange indicator in the direction the door was last moving.

Recall of the door state after initial feedback is possible by simultaneously pressing either HomeLink® buttons 1 and 2 or buttons 2 and 3 for 2 seconds. The last recorded message will be displayed for 3 seconds, again following the garage door status indication of the figure above.

**Clearing the programmed information**

N00585300023

To erase programming from the 3 buttons (individual buttons cannot be erased but can be “reprogrammed” as outlined below), follow the steps noted:

## HomeLink® Wireless Control System (if so equipped)

1. Press and hold the 2 outer HomeLink® buttons for at least 10 seconds. The indicator will change from continuous yellow to rapidly flashing green.
2. Release both buttons.

**NOTE**

- Do not hold for longer than 20 seconds.

3. HomeLink® is now in the train (or learning) mode and can be programmed at any time beginning with “Programming a new HomeLink®” step 1.

**Reprogramming a single HomeLink® button**

N00585400024

To reprogram a HomeLink® button, complete the following.

1. Press and hold the desired HomeLink® button. Do not release the button.
2. The indicator light will begin to slowly flash orange after 20 seconds. The HomeLink® button can be released at this point. Proceed with “Programming a new HomeLink®” step 2.

**NOTE**

- If you do not complete the programming of a new device to the button, it will revert to the previously stored programming. For questions or comments, visit [www.homelink.com](http://www.homelink.com), [www.youtube.com/HomeLinkGentex](http://www.youtube.com/HomeLinkGentex), or by calling the HomeLink® Hotline.

**General information**

N00585600097

Your HomeLink® system operates on a radio frequency subject to Federal Communications Commission (FCC) Rules (For vehicles sold in U.S.A.) and Industry Canada Rules (For vehicles sold in Canada). This device complies with Part 15 of the FCC Rules and RSS- 210 of the Industry Canada Rules. Operation is subject to the following two conditions.

- This device may not cause harmful interference.
- This device must accept any interference that may be received, including interference that may cause undesired operation.

**CAUTION**

- The transmitter has been tested and complies with FCC and IC rules. Changes or modifications not expressly approved by the party responsible for compliance could void the user’s authority to operate the device.

**5**

This equipment complies with FCC radiation exposure limits set forth for an uncontrolled environment. End Users must follow the specific operating instructions for satisfying RF exposure compliance. This transmitter must be at least 8 inches (20 cm) from the user and must not be co-located or operating in conjunction with any other antenna or transmitter. The term “IC:” before the certification/registration number only signifies that Industry Canada technical specifications were met.

## Interior lights

### For vehicles sold in Mexico

La operación de este equipo está sujeta a las siguientes dos condiciones: (1) es posible que este equipo o dispositivo no cause interferencia perjudicial y (2) este equipo o dispositivo debe aceptar cualquier interferencia, incluyendo la que pueda causar su operación no deseada.

5



## Interior lights

N00525301758

### NOTE

- Be aware that leaving the light illuminated with the ready indicator off may run the 12 V starter battery down. Never leave the vehicle without checking that the light is off.

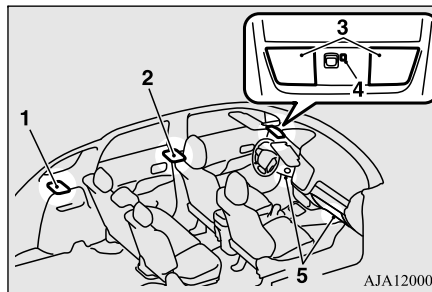

- 1- Cargo room light → P.5-222
- 2- Dome light (rear) → P.5-221
- 3- Dome light (front)/Reading lights → P.5-220
- 4- Downlight → P.5-222
- 5- Front foot lights → P.5-223

## Dome light (front)/Reading lights

N00525401599

### Dome light (front)

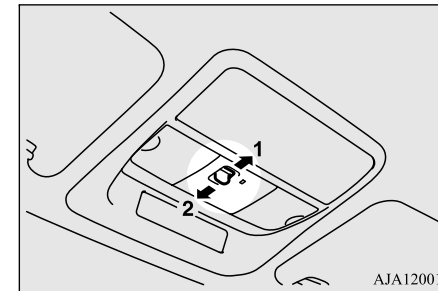

#### 1- (DOOR)

When any of the doors or the liftgate is opened, the dome light illuminates; when any of them are closed, the dome light goes off after approximately 30 seconds. However, the light goes off immediately if:

- The doors and the liftgate are closed while the operation mode of the power switch is in ON.
- The driver's door is closed while the lock knob is in the lock position, after all the other doors are closed.

## Interior lights

- The doors and the liftgate are closed and the power door lock function is used to lock the doors.
- The doors and the liftgate are locked using the F.A.S.T.-key switch or F.A.S.T.-key operation.

### NOTE

- When the operation mode of the power switch is put in OFF while the doors and liftgate are closed, the dome light will illuminate for approximately 30 seconds and then go off.
- The time until the light goes off can be adjusted. See a certified Mitsubishi EV dealer for details. For vehicles equipped with the Smartphone-link Display Audio (SDA), adjustments can be made using screen operations. For details, refer to the separate owner's manual.

- 2- (OFF)  
The dome light stays off regardless of any door or the liftgate being opened or closed.

### Reading lights

N00537601211

Regardless of the dome light switch position, when you press the lens (A), the light on the side that is pressed illuminates; when you press the lens (A) again, the light goes out.

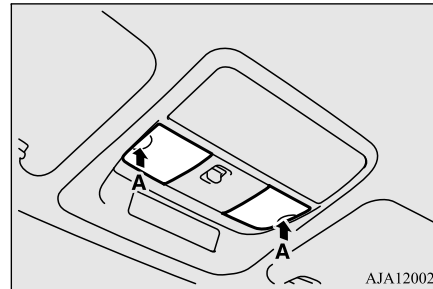

### Dome light (rear)

N00525801405

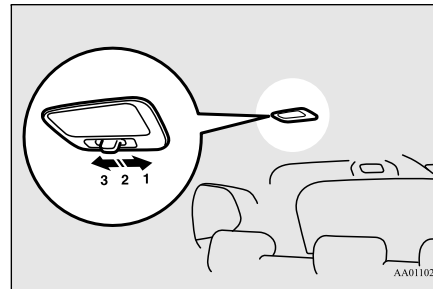

#### 1- (ON)

The dome light illuminates regardless of any door or the liftgate being opened or closed.

#### 2- (●)

When any of the doors or the liftgate is opened, the dome light illuminates; when any of them are closed, the dome light goes off after approximately 30 seconds. However, the light goes off immediately if:

- The door and the liftgate are closed while the operation mode of the power switch is in ON.
- The driver's door is closed while the lock knob is in the lock position, after all the other doors are closed.
- The door and the liftgate are closed and the power door lock function is used to lock the doors.
- The doors and the liftgate are locked using the F.A.S.T.-key switch or F.A.S.T.-key operation.

### NOTE

- When the operation mode of the power switch is put in OFF while the doors and liftgate are closed, the dome light will illuminate for approximately 30 seconds and then go off.

### Interior lights

#### NOTE

- When the dome light switch is in the “ON” position, the light will not go off, even when all the doors and the liftgate are closed.
- The time until the light goes off can be adjusted. See a certified Mitsubishi EV dealer for details. For vehicles equipped with the Smartphone-link Display Audio (SDA), adjustments can be made using screen operations. For details, refer to the separate owner’s manual.

#### 3- (OFF)

The dome light stays off regardless of any door or the liftgate being opened or closed.

### Cargo room light

N00526101186

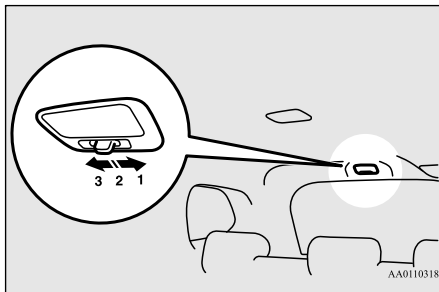

#### 1- (ON)

The cargo room light illuminates regardless of the liftgate being opened or closed.

#### 2- (●)

When the liftgate is opened, the cargo room light illuminates; when it is closed, it goes out.

#### 3- (OFF)

The cargo room light stays out regardless of the liftgate being opened or closed.

### Downlight

N00596000059

The downlight illuminates when the light switch is in the “OFF” or “AUTO” position. When the light switch is in the “AUTO” position, the downlight illuminates when the parking lights illuminate.

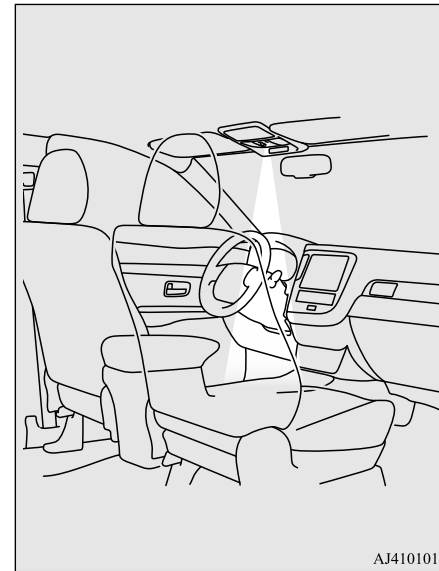

## Front foot lights

N00536901086

The front foot lights (A) come on when the front door is opened and go off when the door is closed.

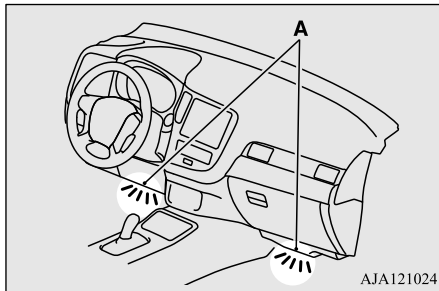

## Interior light\* auto-cutout function

N00526301553

\*: Dome light (front)/Reading lights, dome light (rear) and cargo room light

- If interior lights are left on with the operation mode of the power switch in OFF, the lights go off automatically after approximately 30 minutes.
- The lights come on again if the power switch is operated, if any door or liftgate is opened or closed, or if the F.A.S.T.-key is operated.

## NOTE

- The interior light auto-cutout function can be deactivated. The time until the lights automatically go off can be adjusted. See a certified Mitsubishi EV dealer for details. For vehicles equipped with the Smartphone-link Display Audio (SDA), adjustments can be made using screen operations. For details, refer to the separate owner's manual.

## Storage spaces

N00526401596

## CAUTION

- Never leave lighters, carbonated drink cans, or spectacles in the cabin when parking the vehicle in hot sunshine. The cabin will become extremely hot, so lighters and other flammable items may catch fire and unopened drink cans (including beer cans) may rupture. The heat may also deform or crack plastic spectacle lenses and other spectacle parts that are made of plastic.
- Keep the lids of storage spaces closed while driving the vehicle. A lid or the contents of a storage space could otherwise cause injuries during a sudden stop.

## NOTE

- Do not leave valuables in any storage space when leaving the vehicle.

## Storage spaces

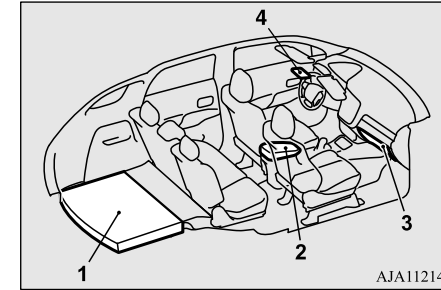

5

- 1- Luggage floor box
- 2- Floor console box
- 3- Glove compartment
- 4- Sunglasses holder (if so equipped)

## Storage spaces

### Glove compartment

N00551501328

#### WARNING

- An open glove compartment door can cause a serious injury or death to the front passenger in an accident, even if the passenger is wearing his/her seat belt. Always keep the glove compartment door closed when driving.

5

To open, pull the lever (A).

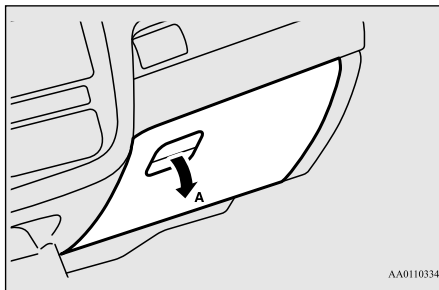

#### NOTE

- When the lights are illuminated with the light switch in the “OFF”, “D” or “AUTO” position, the glove compartment light illuminates.

### Card holder

There is a card holder on the inside of the glove compartment.

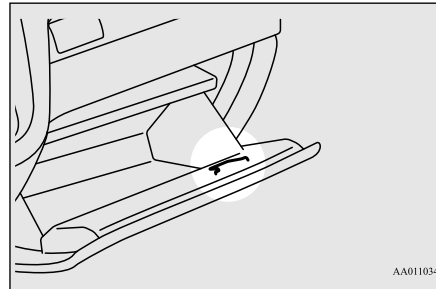

### Floor console box

N00551601332

To open the console box, lift the release lever (A) and raise the lid.

The floor console box can also be used as an arm rest.

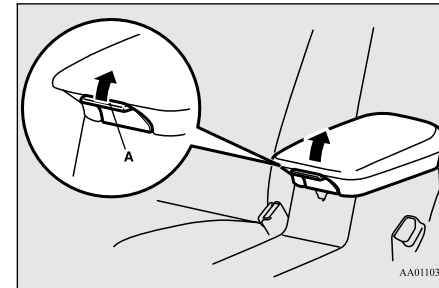



## Luggage floor box

N00552301062

There is a luggage floor box under the luggage floor board.

To use the box, raise the luggage floor board (A).

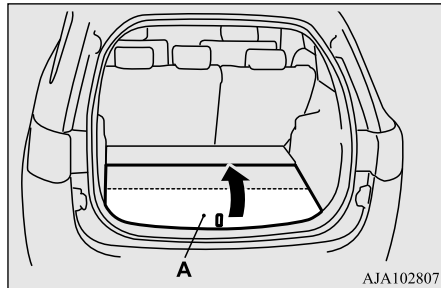

To use the luggage floor box in the rear seat side, insert your hand in the gap (B) and raise the board (A) to the seat side.

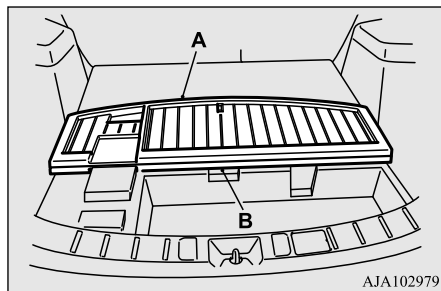

## WARNING

- Do not place any object around the “” mark, since there is the 12 V starter battery under the luggage floor box. If the battery cover is broken, a battery fluid may leak. If it adheres to your skin or gets in your eyes, serious injury may result.

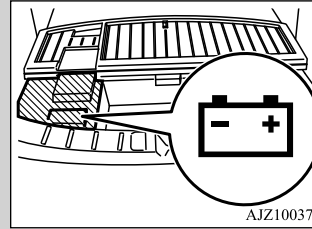

## CAUTION

- Do not use for storing objects heavier than typical sunglasses. There is risk that the holder lid will open accidentally, resulting in an injury due to falling objects.

## NOTE

- Some types of sunglasses cannot fit snugly in the holder. Before storing, check the shape to make sure they fit.

5

## Sunglasses holder (if so equipped)

N00502601103

To open, push the lid.

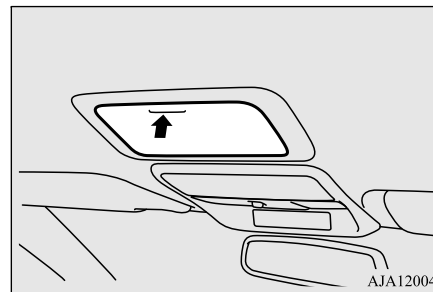

## Cup holders

### Cup holders

N00527301550

The cup holder is designed for holding cups or drink-cans securely in its holes.

#### **⚠ WARNING**

5

- Do not spray water or spill beverages inside the vehicle. If switches, wires, or electrical components become wet, they could malfunction or cause a vehicle fire. If you accidentally spill a beverage, wipe up as much liquid as possible.

### For the front seat

The cup holder is located in front of the floor console.

To use the cup holder, push the lid.

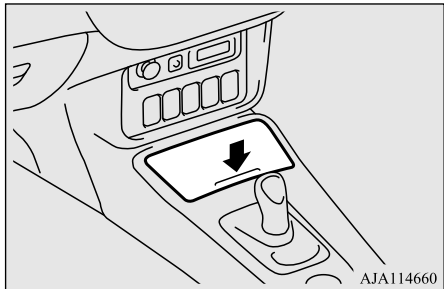

### For the rear seat

N00537001202

This cup holder is located in the rear seat arm rest.

Pull the arm rest down to use the cup holder.

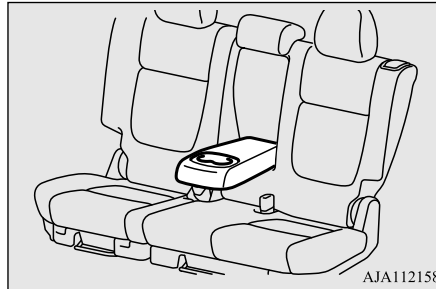

### Bottle holders

N00527301505

#### **⚠ WARNING**

- Do not spray water or spill beverages inside the vehicle. If switches, wires, or electrical components become wet, they could malfunction or cause a vehicle fire. If you accidentally spill a beverage, wipe up as much liquid as possible.

#### **⚠ CAUTION**

- Drink beverages while driving your vehicle is distracting and can cause an accident.
- Vibration and shaking while driving may cause beverages to spill. Be very careful, as spilling hot beverages could cause burns.

There are bottle holders located on both sides of front and rear doors.

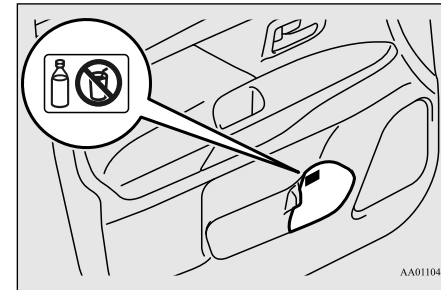

### NOTE

- Do not store cup or drink can in the bottle holder.
- Make sure all lids are tightly closed when storing beverages that are in plastic bottles, etc.
- Some beverages may not be stored, depending on the size and shape of the plastic bottles, etc.

## Cargo area cover (if so equipped)

N00528301166

### To use

1. Pull out the spring-loaded cover and insert it in the mounting grooves (A) on both sides.

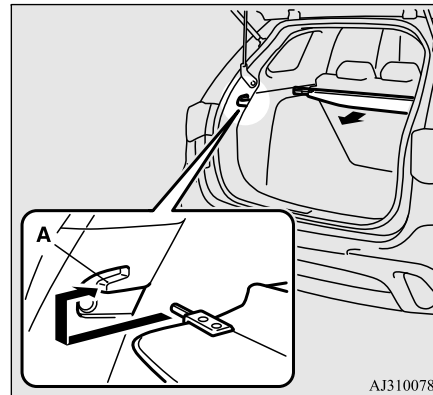

2. Remove the cover from the mounting grooves, and the cover will be rolled back into the retracted position.

### NOTE

- Do not place anything on the cargo area cover.

## Cargo area cover (if so equipped)

### To change position

There are 2 installation holes (B) for the cargo area cover.

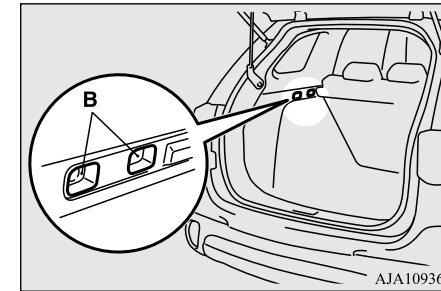

5

1. Move one of the sliders (C) toward the inside of the vehicle, and fit the protruding portion (D) into the installation hole that is to be used. Move the opposite slider in the same fashion.

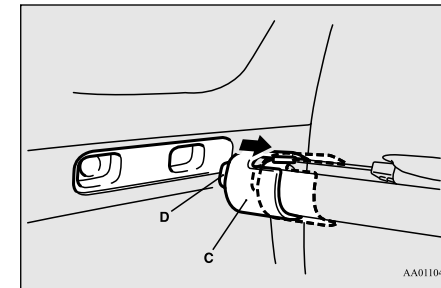

### Assist grips

2. After changing the position, gently shake the entire cargo area cover to make sure it is securely retained.

#### NOTE

- If the rear seat touches the cargo area cover, move the cargo area cover rearward. The cargo area cover could be damaged if it supports the seatback of the rear seats.

5

### To remove

1. Roll back the cargo area cover.
2. Move one of the sliders (C) toward the inside of the vehicle and lift it to remove the cargo area cover.

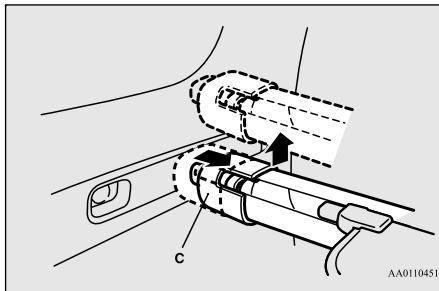

### To refit

To refit the cargo area cover, follow the removal steps in reverse. Gently shake the entire cargo area cover after fitting it to make sure it is securely retained.

### Assist grips

N00559001084

The assist grips (located above the doors on the headliner) are not designed to support body weight. They are intended for use only while seated in the vehicle.

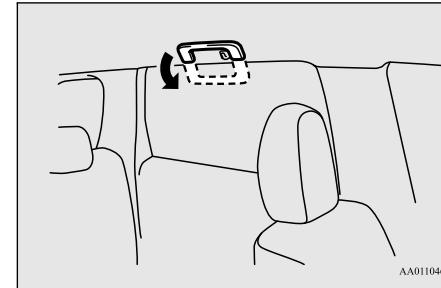

#### CAUTION

- Do not use the assist grips when getting into or out of the vehicle. The assist grips could detach causing you to fall.

## Coat hooks

N00553601176

There is a coat hook on the rear seat assist grip.

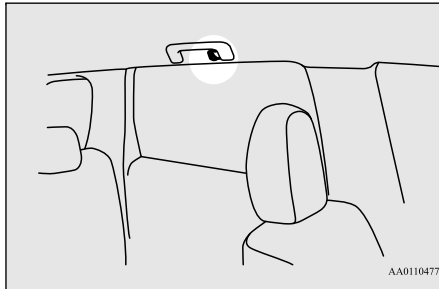

### ⚠ WARNING

- Do not put a hanger or any heavy or pointed object on the coat hook. If the curtain airbag was activated, any such item could be propelled away with great force and could prevent the curtain airbag from inflating correctly. Hang clothes directly on the coat hook (without using a hanger). Make sure there are no heavy or sharp objects in the pockets of clothes that you hang on the coat hook.

## Luggage hooks

N00528501269

There are hooks on the sides of the luggage area for use in securing luggage.

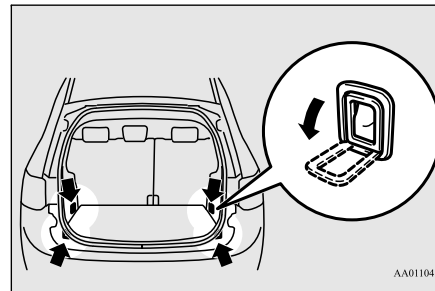

### ⚠ CAUTION

- Do not load the luggage higher than the top of the seatback. Be sure that luggage is firmly secured. Restricted rear vision or flying objects entering the passenger compartment during sudden braking could result in a serious accident.

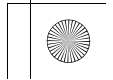
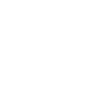
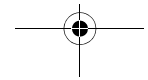
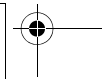
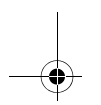
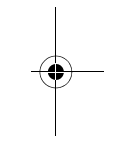
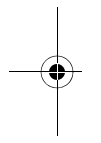
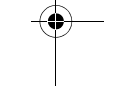
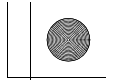
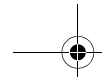
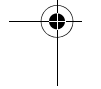
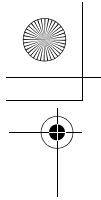



## *Driving safety*

Driving precaution .....	6-2
Fuel economy .....	6-2
Driving, alcohol and drugs .....	6-2
Floor mat .....	6-2
Vehicle preparation before driving .....	6-3
Safe driving techniques .....	6-4
Driving during cold weather .....	6-5
Braking .....	6-5
Parking .....	6-6
Loading information .....	6-6
Cargo loads .....	6-11
Trailer towing .....	6-13
Dinghy towing .....	6-17



## Driving precaution

### Driving precaution

N00629300053

#### WARNING

- Utility vehicles have a significantly higher rollover rate than other types of vehicles. Avoid abrupt maneuvers and excessive speed. Always buckle up.

## 6

Utility vehicles have higher ground clearance and a narrower track, which enables them to perform in a wide variety of off-road situations. Because of the higher ground clearance, these vehicles have a higher center of gravity, which makes them handle differently than ordinary vehicles when driving on pavement. They are not designed to maneuver or corner at the same speed on pavement as conventional 2-wheel drive passenger cars any more than low-slung sports cars are designed to perform satisfactorily in off-road conditions.

Always drive safely and steer the vehicle carefully. Avoid operating the vehicle in a manner that might require sharp turns or abrupt maneuvers. As with other vehicles of this type, failure to operate this vehicle correctly can result in loss of control or vehicle rollover.

In a rollover crash, an unbelted person is significantly more likely to die than a person wearing a seat belt. Before starting the vehi-

## 6-2 Driving safety

cle, always make certain that you and all your passengers are properly wearing their seat belts (with children in the rear seat, in appropriate restraints).

### Fuel economy

N00628801205

Fuel economy is dependent on many factors. Your personal driving habits can have a significant effect on your fuel consumption. Several recommendations for achieving the greatest fuel economy are listed below.

- Whenever accelerating from a stop, always accelerate slowly and smoothly.
- Plan your trips to avoid unnecessary stops.
- Keep your tires inflated to the recommended pressures.
- For freeway driving, maintain a speed of approximately 50 mph (80 km/h) when traffic, roadway and weather conditions safely permit.
- Keep your air filter clean and your vehicle lubricated according to the recommendations in this manual.
- Always keep your vehicle well maintained. A poorly maintained engine wastes fuel and costs money.
- Never overload your vehicle.

### Driving, alcohol and drugs

N00628900049

Drunk driving is one of the most frequent causes of accidents.

Your driving ability can be seriously impaired even with blood alcohol levels far below the legal minimum. If you have been drinking, don't drive. Ride with a designated non-drinking driver, call a cab or a friend, or use public transportation. Drinking coffee or taking a cold shower will not make you sober.

Similarly, prescription and nonprescription drugs affect your alertness, perception and reaction time. Consult with your doctor or pharmacist before driving while under the influence of any of these medications.

#### WARNING

- NEVER DRINK AND DRIVE. Your perceptions are less accurate, your reflexes are slower and your judgment is impaired.

### Floor mat

N00628600033

The original equipment floor mat provided with your vehicle was specifically designed for your vehicle.

Always properly position the floor mat and assure it does not interfere with operation of



the pedals. Always use the retaining clip on the driver's floorboard to secure the floor mat. When used, this clip will help prevent the floor mat from moving forward and possibly interfering with the operation of the pedals. To prevent the floor mat from moving forward and possibly interfering with the operation of the pedals, Mitsubishi genuine floor mats are recommended.

### To install the floor mat

N00628701086

1. Place the floor mat to fit the shape of the floorboard.
2. Align the floor mat with the installation holes over the retaining clips.
3. Secure the floor mat with retaining clips.

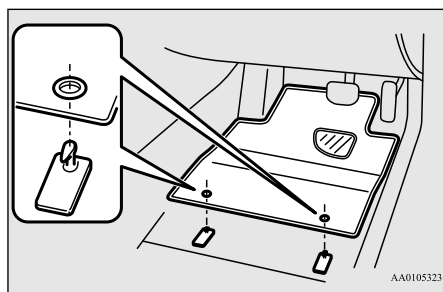

### NOTE

- The shape of the mat and the number of retaining clips may vary depending on the vehicle model.

### WARNING

- If a floor mat is the wrong size or is not properly installed, it can interfere with the operation of the pedals. Interference with the pedals can cause unintended acceleration and/or increased stopping distances resulting in a crash and injury. Always make sure the floor mat does not interfere with the accelerator or brake pedal.
- Always use the retaining clip on the driver's floorboard to secure the floor mat.
- Always install the mat with the correct side facing down.
- Never install a second mat over or under an existing floor mat.
- Do not use a floor mat designed for another model vehicle even if it is a Mitsubishi genuine floor mat.
- Before driving, be sure to check the following:
  - Periodically check that the floor mat is properly secured with the retaining clips. If you remove the floor mat while cleaning the inside of your vehicle or for any other reason, always check the condition of the floor mat after it has been reinstalled.

### Vehicle preparation before driving

### WARNING

- While the vehicle is stopped with the Plug-in Hybrid EV system off, check that the floor mat is not interfering with the pedals by depressing the pedals fully.

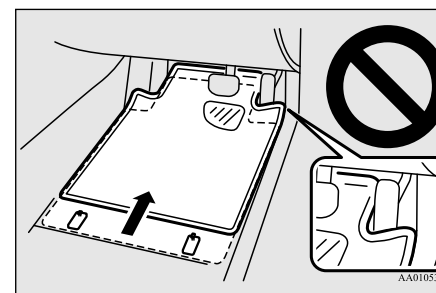

6

### Vehicle preparation before driving

N00629001813

For a safer and more enjoyable trip, always check for the following:

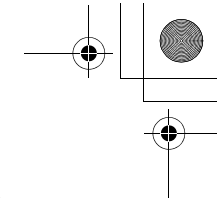

## Safe driving techniques

### Seat belts and seats

6

- Before starting the vehicle, make certain that you and all passengers are seated and wearing their seat belts properly (with children in the rear seat, in appropriate restraints), and that all the doors and the liftgate are locked.
- Move the driver's seat as far backward as possible, while keeping good visibility, and good control of the steering wheel, brakes, accelerator, and controls. Check the instrument panel indicators and multi-information display for any possible problem.
- Similarly, the front passenger seat should also be moved as far back as possible.
- Make sure that infants and small children are properly restrained in accordance with all laws and regulations.

### Defrosters

Check these by selecting the defroster mode, and set the blower switch on high. You should be able to feel the air blowing against the windshield.

Refer to "Defrosting or defogging (windshield, door windows)" on page 7-13

### Tires

Check all the tires for heavy tread wear or uneven wear patterns. Look for stones, nails, glass, or other objects stuck in the tread. Look for any tread cuts or sidewall cracks. Check the wheel nuts for tightness, and the tires for proper pressure. Replace your tires before they are heavily worn out.

As your vehicle is equipped with a tire pressure monitoring system (TPMS), there is a risk of damage to the tire inflation pressure sensors when the tire is replaced on the rim. Tire replacement should, only, be performed by a certified Mitsubishi EV dealer.

### Lights

Have someone watch while you turn all the exterior lights on and off. Also check the turn signal indicators and high-beam indicators on the instrument panel.

### Fluid leaks

Check the ground under the vehicle after parking overnight, for fuel, water, oil, or other leaks. Make sure all the fluid levels are correct. Also, if you can smell fuel, you need

to find out why immediately and have it fixed.

## Safe driving techniques

N00629201134

Even this vehicle's safety equipment, and your safest driving, cannot guarantee that you can avoid an accident or injury. However, if you give extra attention to the following areas, you can better protect yourself and your passengers:

- Drive defensively. Be aware of traffic, road and weather conditions. Leave plenty of stopping distance between your vehicle and the vehicle ahead.
- Before changing lanes, check your mirrors, blind spots, and use your turn-signal light.
- While driving, watch the behavior of other drivers, bicyclists, and pedestrians.
- Always obey applicable laws and regulations. Be a polite and alert driver. Always leave room for unexpected events, such as sudden braking.
- If you plan to drive in another country, obey their vehicle registration laws and make sure you will be able to get the right fuel.

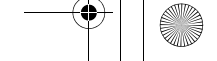
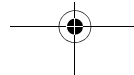

## Driving during cold weather

N00629401501

- Check the 12 V starter battery, including terminals and cables. During extremely cold weather, the 12 V starter battery will not be as strong and its power level may drop.

Before driving the vehicle, check to see if the headlights are as bright as normally. Charge or replace the 12 V starter battery if necessary. During extreme cold weather, it is possible that a very low 12 V starter battery could freeze.

### ⚠ WARNING

- **The 12 V starter battery gives off explosive hydrogen gas. Any spark or flame can cause the battery to explode, which could cause serious injury or death.**

**Always wear protective clothes and a face mask when working with your 12 V starter battery, or let a skilled mechanic do it.**

- Stay at low speeds at first so that the transaxle, transfer case and rear axle oil have time to spread to all lubrication points.
- Check the engine antifreeze.

If there is not enough coolant because of a leak or from engine overheating, add Mitsubishi Motors Genuine Super Long Life Coolant Premium or equivalent.

Please read this section in conjunction with the “Engine coolant/Plug-in Hybrid EV system coolant” on page 9-8.

### ⚠ WARNING

- **Never open the radiator cap when the radiator is hot. You could be seriously burned.**

## Braking

N00629501560

All the parts of the brake system are critical to safety. Have the vehicle serviced by a certified Mitsubishi EV dealer at regular intervals according to the “WARRANTY AND MAINTENANCE MANUAL”.

### When brakes are wet

Check the brake system while driving at a low speed immediately after starting, especially when the brakes are wet, to confirm they work normally.

A film of water can be formed on the brake discs and prevent normal braking after driving in heavy rain or through large puddles, or

### Driving during cold weather

after the vehicle is washed. If this occurs, dry the brakes out by driving slowly while lightly depressing the brake pedal.

### When driving in cold weather

On snowy roads, ice can form on the braking system, making the brakes less effective. While driving in such conditions, pay close attention to surrounding vehicles and to the condition of the road surface. From time to time, lightly depress the brake pedal and check how effective the brakes are.

6

### When driving down a long hill

Put the select position to “B” (REGENERATIVE BRAKE) according to the grade of the slope and vehicle speed, and use the service brake in combination with the regenerative brake as required.

### 📖 NOTE

- If the brake pedal is continuously or frequently depressed on downhill roads, the service brake could overheat and the brake performance will be reduced.
- If regenerative braking is applied continuously on downhill roads, the regenerative brake may temporarily turn off.

## Parking

### NOTE

- When the main drive lithium-ion battery level is full or nearly full, or the main drive lithium-ion battery temperature is too high or too low, the regenerative braking force may temporarily be reduced or eliminated. Refer to “Regenerative braking” on page 3-4.
- If the needle in the energy usage indicator does not move to the left of the neutral point (A) while the accelerator pedal is released, the regenerative brake will not work. Refer to “Energy usage indicator” on page 5-138. In the such case, before approaching a long downhill road, reduce speed to prevent the service brake from overheating.

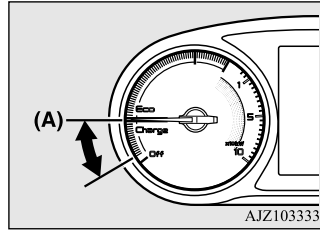

AJZ103333

## Parking

N00629601369

### Parking on a hill

When parking on a hill, set the parking brake, and turn the front wheels toward the curb on a downhill, or away from the curb on an uphill.

6-6 Driving safety

If necessary, apply chocks to the wheels.

Be sure that the parking brake is firmly set when parked and that the electrical parking switch is pressed.

### Parking with the Plug-in Hybrid EV system running

Never leave the Plug-in Hybrid EV system running while you take a short nap or rest. Also, never leave the Plug-in Hybrid EV system running in a closed or poorly ventilated place.

### WARNING

- Leaving the Plug-in Hybrid EV system running risks injury or death from accidentally moving the selector lever or the accumulation of toxic exhaust fumes in the passenger compartment.

### Where you park

Your front bumper can be damaged if you scrape it over curbs or parking stop blocks. Be careful when traveling up or down steep slopes where your bumper can scrape the road.

### WARNING

- Do not park your vehicle in areas where combustible materials such as dry grass or leaves can come in contact with a hot exhaust, since a fire could occur.

### When leaving the vehicle

Always carry the key and lock all doors and the liftgate when leaving the vehicle unattended.

Always try to park your vehicle in a well lit area.

### Do not keep the steering wheel fully turned for a long time

Move effort could be required to turn the steering wheel.

Refer to “Electric power steering system (EPS)” on page 5-80.

### Loading information

N00629901489

It is very important to know how much weight your vehicle can carry. This weight is called the vehicle capacity weight and includes the

## Loading information

weight of all occupants, cargo (including the roof load), non-factory-installed options, and the tongue weight of the trailer, if any, being towed. The tire and loading information placard located on the driver's door sill of your vehicle will show how much weight it may properly carry.

**⚠ WARNING**

- **Never overload your vehicle. Overloading can damage your vehicle, adversely affect vehicle performance, including handling and braking, cause tire failure, and result in an accident.**

It is important to familiarize yourself with the following terms before loading your vehicle:

- **Vehicle maximum load on the tire:** load on an individual tire that is determined by distributing to each axle its share of the maximum loaded vehicle weight and dividing by two.
- **Vehicle normal load on the tire:** load on an individual tire that is determined by distributing to each axle its share of the curb weight, accessory weight, and normal occupant weight and dividing by two.
- **Maximum loaded vehicle weight:** the sum of -
  - (a) Curb weight;
  - (b) Accessory weight;
  - (c) Vehicle capacity weight; and
  - (d) Production options weight.
- **Curb weight:** the weight of a motor vehicle with standard equipment including the maximum capacity of fuel, oil, and coolant.
- **Accessory weight:** the combined weight (in excess of those standard items which may be replaced) of transaxle, power steering, power brakes, power windows, power seats, radio, and heater, to the extent that these items are available as factory-installed equipment (whether installed or not).
- **Vehicle capacity weight:** the rated cargo and luggage load plus 150 lbs (68 kg) \*times the vehicle's designated seating capacity.
- **Production options weight:** the combined weight of those installed regular production options weighing over 5 lbs (2.3 kg) in excess of those standard items which they replace, not previously considered in curb weight or accessory weight, including heavy duty brakes, ride levelers, roof rack, heavy duty battery, and special trim.

### Loading information

- Normal occupant weight: 150 lbs (68 kg) \*times the number of specified occupants (3 in the case of your vehicle)
- Occupant distribution: Occupant distribution within the passenger compartment (In your vehicle the distribution is 2 in front, 1 in rear seat)

6

\*:150 lbs (68 kg) is the weight of one person as defined by U.S.A. and Canadian regulations.

### Tire and loading information placard

N00630101449

The tire and loading information placard is located on the inside sill of the driver's door.

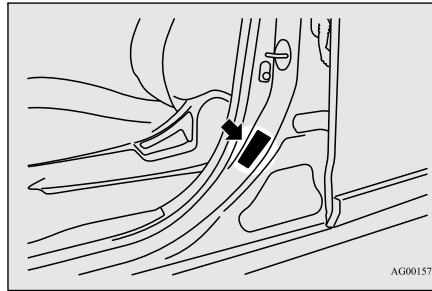

This placard shows the maximum number of occupants permitted to ride in your vehicle as well as “the combined weight of occupants and cargo” (A), which is called the vehicle capacity weight. The weight of any non-factory installed options, as well as the tongue weight of a trailer being towed and roof load is included in the definition of “cargo” when determining the vehicle capacity weight. This placard also tells you the size and recommended inflation pressure for the original equipment tires on your vehicle. For more information, refer to “Tires” on page 9-12.

### Type 1

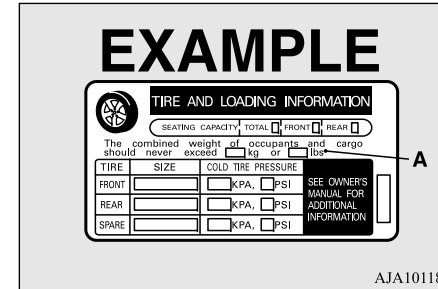

### Type 2

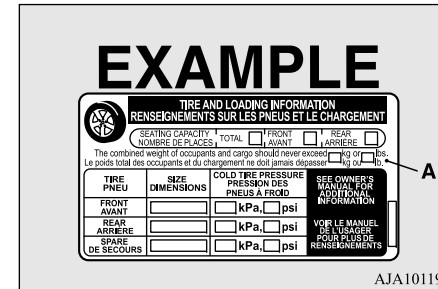



## Steps for Determining Correct Load Limit

N00630201293

1. Locate the statement “The combined weight of occupants and cargo should never exceed XXX kg or XXX lbs.” on your vehicle’s placard.
2. Determine the combined weight of the driver and passengers that will be riding in your vehicle.
3. Subtract the combined weight of the driver and passengers from XXX kg or XXX lbs.
4. The resulting figure equals the available amount of cargo and luggage load capacity. For example, if the “XXX” amount equals 1400 lbs. and there will be five 150 lbs. passengers in your vehicle, the amount of available cargo and luggage load capacity is 650 lbs. (1400 - 750 (5 x 150) = 650 lbs.)
5. Determine the combined weight of luggage and cargo being loaded on the vehicle. That weight may not safely exceed the available cargo and luggage load capacity calculated in Step 4.
6. If your vehicle will be towing a trailer, load from your trailer will be transferred to your vehicle. Consult this manual to determine how this reduces the available cargo and luggage load capacity of your vehicle.

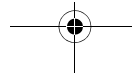
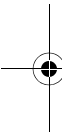

Loading information

**NOTE**

- The following table shows examples on how to calculate total load, cargo/luggage and towing capacities of your vehicle with varying seating configurations and number and size of occupants. This table is for illustration purposes only and may not be accurate for the seating and load carry capacity of your vehicle.
- For the following example the combined weight of occupants and cargo should never exceed 865 lbs (392 kg).

**6**

Occupants			Combined weight of occupants and cargo from Tire Placard	MINUS	Combined Occupant's weight	=	AVAILABLE Cargo/Luggage and Trailer Tongue Weight
TOTAL	FRONT	REAR					
<u>EXAMPLE 1</u>							
5	2	3	865 lbs (392 kg)	minus	Occupant 1: 200 lbs (91 kg) Occupant 2: 130 lbs (59 kg) Occupant 3: 160 lbs (73 kg) Occupant 4: 100 lbs (45 kg) Occupant 5: 80 lbs (36 kg) TOTAL WEIGHT: 670 lbs (304 kg)	=	195 lbs (88 kg)
					670 lbs (304 kg)		
<u>EXAMPLE 2</u>							
3	2	1	865 lbs (392 kg)	minus	Occupant 1: 210 lbs (95 kg) Occupant 2: 180 lbs (82 kg) Occupant 3: 150 lbs (68 kg) TOTAL WEIGHT: 540 lbs (245 kg)	=	325 lbs (147 kg)
					540 lbs (245 kg)		
<u>EXAMPLE 3</u>							
2	2	0	865 lbs (392 kg)	minus	Occupant 1: 200 lbs (91 kg) Occupant 2: 200 lbs (91 kg) TOTAL WEIGHT: 400 lbs (182 kg)	=	465 lbs (210 kg)
					400 lbs (182 kg)		

AJM100083



**NOTE**

- Under a maximum loaded vehicle condition, gross axle weight ratings (GAWR's) for the front and rear axles must not be exceeded. For further information on GAWR's, vehicle loading and trailer towing, see the "Specifications" section of this manual.

**Cargo loads**

N00629700435

**Cargo load precautions**

N00630301151

To determine the cargo load capacity for your vehicle, subtract the weight of all vehicle occupants from the vehicle capacity weight. For additional information, if needed, refer to "Steps for Determining Correct Load Limit" on page 6-9.

DO NOT USE the Gross Vehicle Weight Rating and Gross Axle Weight Rating numbers listed on the safety certification label located on the inside sill of the driver's door as the guide for passengers and/or cargo weight.

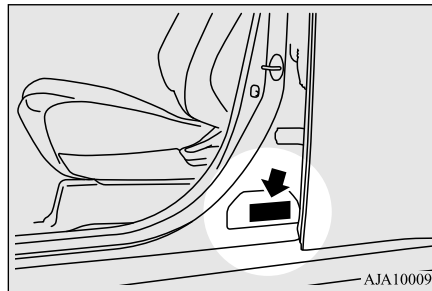

**WARNING**

- Do not load cargo or luggage higher than the top of the seatback. Be sure that your cargo or luggage cannot move when your vehicle is in motion.
- Having either the rear view blocked, or your cargo being thrown inside the cabin if you suddenly have to brake can cause a serious accident or injury or death.
- Put cargo or luggage in the cargo area of your vehicle. Try to spread the weight evenly.

6

**WARNING**

- To reduce the risk of serious injury or death, the combined weights of the driver, passengers and cargo must never exceed the vehicle capacity weight.
- Exceeding the vehicle capacity weight will adversely affect vehicle performance, including handling and braking, and may cause an accident.

**Loading cargo on the roof**

N00630401152

**WARNING**

- Weight placed on the roof of the vehicle will raise the vehicle's center of gravity and adversely affect its handling characteristics. As a result, driving errors or emergency maneuvers could lead to a loss of control and result in an accident. Drive slowly and avoid excessive maneuvers such as sudden braking or quick turning.

## Cargo loads

6

### ⚠ WARNING

- Make sure that the weight of luggage and the roof carrier do not exceed the maximum roof load, 110 lb (50 kg). If the maximum roof load is exceeded, this could cause damage to the vehicle or result in an accident.
- The total weight of all occupants and luggage, including your roof load, must not exceed the vehicle capacity weight. For more information, refer to “Tire and loading information placard” on page 11-3
- Roof load is determined by adding the weight of the roof carrier and the weight of the luggage placed on the roof carrier.
- For additional information, refer to “Vehicle weights: Maximum roof load” on page 11-5.

### ⚠ CAUTION

- Do not load luggage directly onto the roof. Use a roof carrier that properly fits your vehicle.
- For installation, refer to the instruction manual provided with the roof carrier.
- Place the luggage on the carrier so that its weight is distributed evenly with the heaviest items on the bottom. Do not load items that are wider than the roof carrier.

### ⚠ CAUTION

- Before driving and after traveling a short distance, always check the load to make sure it is securely fastened to the roof carrier. Stop the vehicle periodically and check that the load remains secure. If the load is not secure, it could fall from the vehicle and damage your vehicle, another vehicle or create a road hazard.

### 📖 NOTE

- To prevent wind noise or reduction in gas mileage, remove the roof carrier when not in use.
- Before using an automatic car wash, check with the attendant to determine if the roof carrier should be removed.

## Roof carrier mounting bracket cover (if so equipped)

N00630601112

When installing the roof carrier, use the provided brackets.  
The brackets are located under each cover.

### To remove the covers

1. Slide each cover (A) toward the front of the vehicle.
2. Lift the front edge of the cover (A).

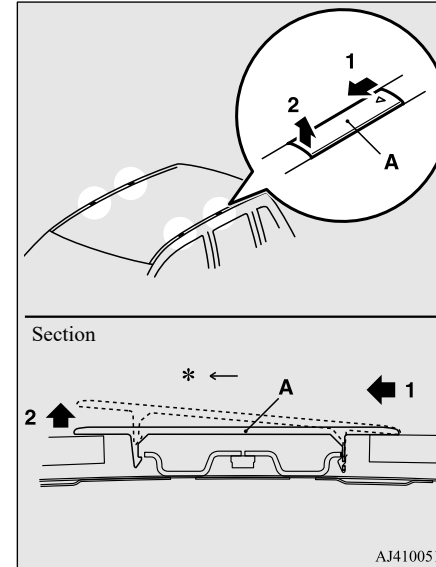

\*: Front of the vehicle

### To install the covers

Install the covers by performing the removal step in reverse.

## Trailer towing

N00629801404

Towing a trailer will adversely affect your vehicle's handling, performance, braking, durability and driving economy (fuel consumption, etc.).

If you do tow a trailer with this vehicle, be sure to use proper equipment and cautious steering and braking for safe driving.

### CAUTION

- Do not lose control of your vehicle when towing a trailer.
  - Always use proper equipment.
  - Always drive carefully
- Damage to your vehicle caused by improper equipment or driving is not covered by your warranty.

### NOTE

- We recommend that you charge the main drive lithium-ion battery before towing a trailer.

## Weight limits

Never exceed the vehicle capacity weight, maximum trailer weight (A), maximum tongue weight (B) and Gross Axle Weight Rating (GAWR).

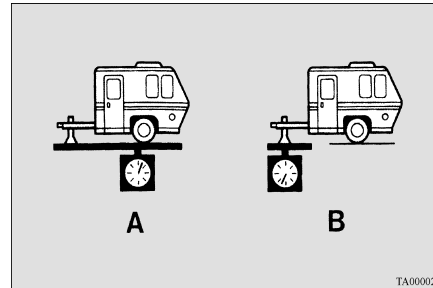

## Vehicle capacity weight

The vehicle capacity weight is printed on the tire and loading information placard as “combined weight of occupants and cargo”.

The weight includes the weight of all occupants and the total weight it can carry.

For more information, refer to “Tire and loading information placard” on

page 6-8.

## Maximum trailer weight

Recommendations for towing up to this limit are as follows.

With brake: 1,500 lb (680 kg)

Without brake: 1,250 lb (567 kg)

6

## Tongue weight

The tongue weight of any trailer is important because it affects the vehicle capacity weight.

The vehicle capacity weight includes any cargo you may carry, and the people who will be riding in the vehicle. If you will tow a trailer, you must include the tongue weight of the trailer in your calculation of the vehicle capacity weight. For more information regarding vehicle capacity weight, refer to “Tire and loading information placard” on page 6-8.

Do not exceed the maximum tongue weight for your vehicle.

With brake: 150 lb (68 kg)

Without brake: 125 lb (57 kg)



## Trailer towing

After you've loaded your trailer, weigh the trailer and then the tongue, separately, to see if the weights are proper.

Keep the trailer tongue load at 10% of the loaded trailer weight for dead weight hitches. Tongue loads can be adjusted by proper distribution of the load in the trailer. This can be checked by separately weighing the loaded trailer and then the tongue.

**6**

## Gross axle weight rating (GAWR)

The GAWRs are printed on the certification label which is riveted on the door sill on the driver's side.

Refer to "Vehicle labeling" on page 11-2.

## Trailer hitches

Choose a proper hitch and ball, and make sure it is installed at a height that is compatible with the trailer.

Use a good equalizing hitch which uniformly distributes the trailer tongue load throughout the frame.

6-14 Driving safety

### WARNING

- If you make any holes in the body of your vehicle for installing a trailer hitch, be sure to seal the holes later when you remove the hitch. If you don't seal them, deadly carbon monoxide (CO) from your exhaust can enter your vehicle. Refer to "Exhaust system" on page 9-23.

### NOTE

- Mitsubishi Motors recommends that sway control be used whenever you are towing, to improve towing stability. For further information, please contact a certified Mitsubishi EV dealer.

## Safety chains

A safety chain must always be used between the towing vehicle and the trailer. Leave sufficient slack in the chain for turns. The chain should cross under the trailer tongue to prevent the tongue from dropping to the ground in case it becomes damaged or separated.

For correct safety chain procedures, consult a certified Mitsubishi EV dealer.

### CAUTION

- Never tow a trailer without using a safety chain securely attached to both the trailer and the vehicle. If the coupling unit or hitch ball experiences a problem, the trailer may separate from your vehicle.

## Maintenance when trailer towing

Your vehicle will need service more often when you're towing a trailer. Refer to "WARRANTY AND MAINTENANCE MANUAL". Especially important in trailer operation are automatic transaxle fluid, engine oil, rear axle oil, belt, cooling system and brake system. Each of these is covered in this manual.

For details, please refer to the "Vehicle care and maintenance" section.

Check periodically to see that all hitch nuts and bolts are tight.

## Trailer brakes

Mitsubishi Motors recommends that any trailer having a total weight of 1,250 lb (567 kg) or more be equipped with its own electric or surge-type brakes.

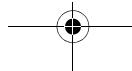
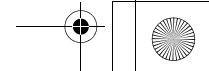
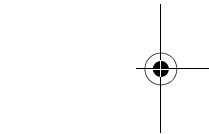
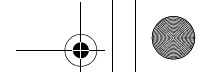

If you choose electric brakes, be sure they are electrically actuated. Do not attempt to tap into your vehicle's hydraulic system. No matter how successful it may seem, any attempt to attach trailer brakes to your vehicle's hydraulic system will lower braking effectiveness and create a potential hazard.

### Trailer lights

Trailer lights and equipment must comply with federal, state, and local regulations. Check with your local recreational vehicle dealer for the requirements in your area, and use only equipment designed for your vehicle.

Since lighting and wiring vary by trailer type and brand, you should have a qualified technician install a suitable connector between the vehicle and the trailer. Improper equipment or installation can cause damage to your vehicle's electrical system and affect your vehicle warranty.

### Additional trailer equipment

Many states and Canadian provinces require special outside mirrors when towing a trailer. Even if not required, you should install spe-

cial mirrors if you cannot clearly see behind you, or if the trailer creates a blind spot.

Ask your trailer sales or rental agency if any other items are recommended or required for your towing situation.

### Operating hints

#### **⚠ WARNING**

- **If you have a rear window open and you tow a trailer with your vehicle, carbon monoxide gas which you cannot see or smell could come into your vehicle. It can cause unconsciousness or death. Refer to "Exhaust system" on page 9-23.**  
To maximize your safety when towing a trailer:
- **Have your exhaust system inspected for leaks, and make necessary repairs before starting on your trip.**
- **Keep the rear windows closed.**
- **If exhaust does come into your vehicle through a window or another opening, drive with your front, main heating or cooling system on and with the blower on any speed. This will bring fresh, outside air into your vehicle. Do not use recirculation because it only recirculates the air inside your vehicle. Refer to "Air selection switch" on page 7-10.**

### Driver preparation

Towing a trailer requires a certain amount of experience.

Before setting out for the open road, you'll want to get to know your trailer. Acquaint yourself with the feel of handling and braking with the added weight of the trailer. Always keep in mind that the vehicle you are driving is now a good deal longer and not nearly as responsive as your vehicle is without a trailer.

### Vehicle preparation

Before you start, check the trailer hitch, safety chains, tires and mirror adjustment.

### Tire

Be sure your vehicle's tires are inflated to the cold inflation pressure listed in the manual. You'll find these numbers on the tire and loading information placard at the sill of the driver's door.

Refer to "Tire inflation pressures" on page 9-17.

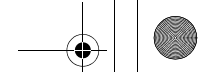

## Trailer towing

### Following distance

Stay at least twice as far behind the vehicle ahead as you would when driving your vehicle without a trailer. This can help you avoid situations that require heavy braking and sudden turns.

## 6 Passing

You'll need more passing distance up ahead when you're towing a trailer. And, because you're a good deal longer, you'll need to go much farther beyond the passed vehicle before you can return to your lane.

### Backing up

Hold the bottom of the steering wheel with one hand. Then, to move the trailer to the left, just move that hand to the left. To move the trailer to the right, move your hand to the right. Always back up slowly and, if possible, have someone guide you.

### Making turns

#### CAUTION

- Making sharp turns while towing a trailer could cause the trailer to come in contact with the vehicle. Your vehicle could be damaged. Avoid making sharp turns while towing a trailer.

When you're turning with a trailer, make wider than normal turns to help prevent the trailer from striking shoulders, curbs, road signs, trees or other objects.

Avoid jerky or sudden maneuvers. Signal well in advance.

### Overheating

Towing a trailer puts additional burden on the electric motor, engine and transaxle, which may cause overheating. Following are some suggestions to reduce overheating:

Cause of overheating	Solution
Air conditioning on	Turn off
Highway speeds	Reduce speed

When towing at high altitudes, engine coolant and automatic transaxle oil will overheat at a lower temperature than at normal altitudes.

If you turn your Plug-in Hybrid EV system off immediately after towing at high altitude on steep uphill grades, your vehicle may show signs similar to overheating. To avoid this, let the Plug-in Hybrid EV system run while parked (preferably on level ground) with the automatic transaxle in the "P" (PARK) position for a few minutes before turning the Plug-in Hybrid EV system off.

- If the engine coolant temperature warning display appears on the information screen in the multi-information display, refer to "Engine overheating" on page 8-4.

### Driving on hills

Reduce speed and shift the select position to "B" (REGENERATIVE BRAKE) before you start down a long or steep downgrade. If you don't shift the select position to "B" (REGENERATIVE BRAKE), over using the brakes can cause reduced brake efficiency.

You can tow in "D" (DRIVE) position. When the remaining quantity of the main drive lithium-ion battery is low, or high-speed driving on long up hills at high temperature, the main drive lithium-ion battery output is restricted and the vehicle speed may be decreased.

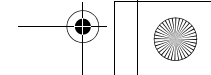
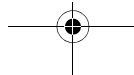

The vehicle speed may be recovered if the main drive lithium-ion battery quantity is recovered.

### Parking

Always place chocks or blocks under both the vehicle and trailer wheels when parking. Be sure that the parking brake is firmly set and that the electrical parking switch is pressed. Avoid parking on a hill with a trailer, but if it cannot be avoided, do so only after performing the following:

1. Apply the brakes and keep them applied.
2. Have someone place chocks or blocks under both the vehicle and trailer wheels.
3. When the chocks or blocks are in place, release your brakes slowly until the chocks or blocks absorb the load.
4. Apply the parking brake firmly.
5. Press the electrical parking switch and turn off the Plug-in Hybrid EV system.

When restarting out after parking on a hill:

1. Start the Plug-in Hybrid EV system. Be sure to keep the brake pedal depressed.
2. Set the select position to the “D” (DRIVE) position or “R” (REVERSE) position.

3. Release the parking brake and brake pedal and slowly pull or back away from the chocks or blocks. Stop and apply your brakes.
4. Have someone retrieve the chocks or blocks.

### Dinghy towing

N00630701025

Dinghy towing is towing the vehicle with all four wheels on the ground.

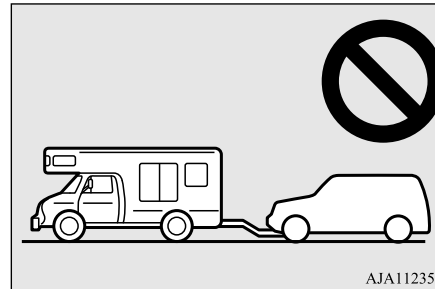

### CAUTION

- Your vehicle is not designed to be dinghy towed behind a motor home.
- Dinghy towing can cause damage to the electric motor unit. Damage caused by dinghy towing will not be covered by the vehicle warranty.

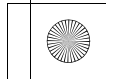
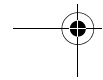
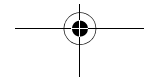
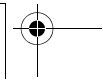
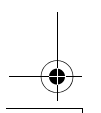
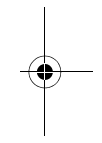
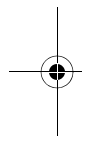
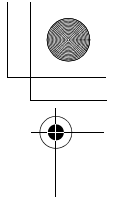
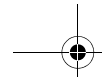
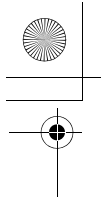

Handwriting practice area consisting of ten horizontal dashed lines.



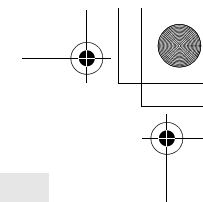
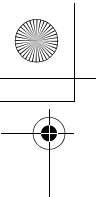

# *Comfort controls*

Vents .....7-2  
 Dual-zone automatic climate control air conditioner .....7-4  
 Important air conditioning operating tips .....7-14  
 Air purifier .....7-15  
 Remote Climate Control (if so equipped).....7-15  
 Heating .....7-15  
 General information about your radio .....7-16

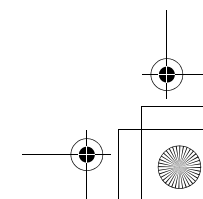
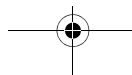
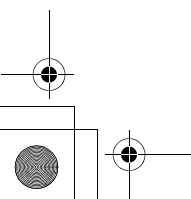
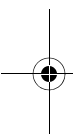

## Vents

### Vents

N00729901334

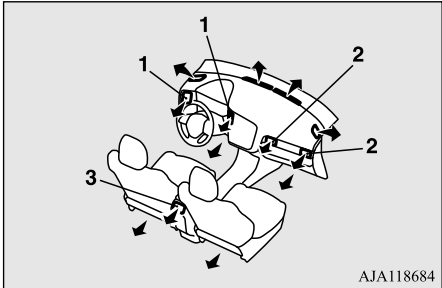

AJA118684

7

- 1- Driver's vents
- 2- Passenger's vents
- 3- Rear vents

### Air flow and direction adjustments

N00730201395

#### NOTE

- On rare occasions, air from the vents of an air-conditioned vehicle may be foggy. This is due to only moist air cooling suddenly and it does not indicate a problem.
- Do not let drinks or other liquids get into the vents as they could prevent the air conditioning from operating normally.

### Driver's vents

Move the knob (A) to make adjustments.  
To close the vent, fully move the knob (A) to the outer side.

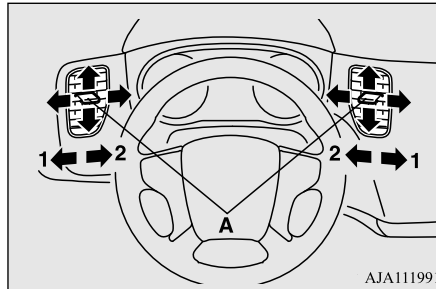

AJA111991

- 1- Close
- 2- Open

### Passenger's vents

Move the knob (A) to make adjustments.  
To close the vent, fully move the knob (A) to the left side.

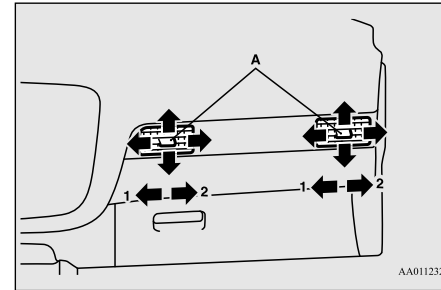

AA0112325

- 1- Close
- 2- Open

## 7-2 Comfort controls

### Rear vents

The vent can be opened and closed with the dial (A).

(≡) - Open

(☒) - Close

Adjust the direction of the air flow by moving the knob (B).

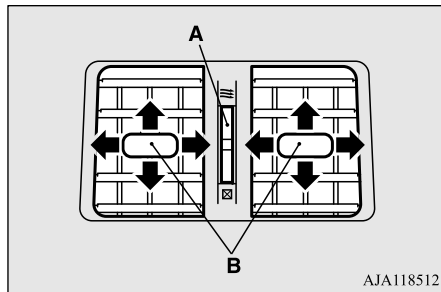

### Changing the mode selection

N00736401810

To change the position and amount of air flowing from the vents, press the MODE switch or defogger switch. Refer to “MODE switch” on page 7-9, “Defogger switch” on page 7-9.

These symbols are used in the next several illustrations to demonstrate the quantity of air coming from the vents.

→ : Small amount of air from the vents

➔ : Medium amount of air from the vents

➤ : Large amount of air from the vents

### Face position

Air flows only to the upper part of the passenger compartment.

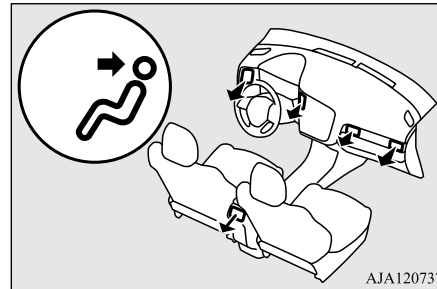

### Foot/Face position

Air flows to the upper part of the passenger compartment, and flows to the leg area.

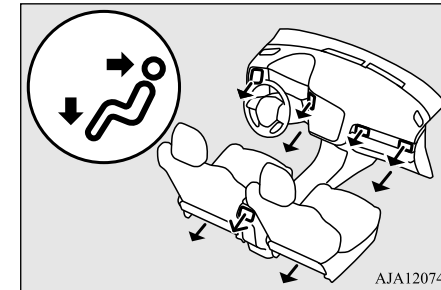

7

### NOTE

- The foot/face air flow ratio can be adjusted with the mode selection in the “➤” position. For further information, we recommend you to consult a certified Mitsubishi EV dealer. On vehicles equipped with the Smartphone-link Display Audio (SDA), screen operations can be used to make the adjustment. Refer to the separate owner’s manual for details.

## Dual-zone automatic climate control air conditioner

### Foot position

Air flows mainly to the leg area.

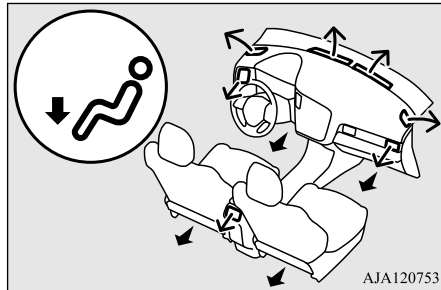

7

### Foot/Defroster position

Air flows to the leg area, the windshield and the door windows.

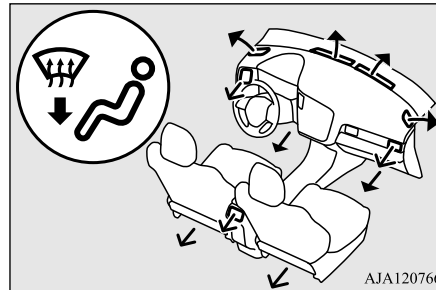

### Defroster position

Air flows mainly to the windshield and the door windows.

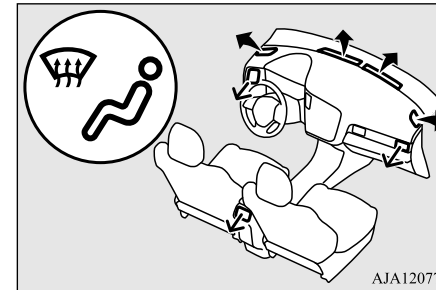

### NOTE

- The foot/defroster air flow ratio can be adjusted with the mode selection in the “” position. For further information, we recommend you to consult a certified Mitsubishi EV dealer. On vehicles equipped with the Smartphone-link Display Audio (SDA), screen operations can be used to make the adjustment. Refer to the separate owner’s manual for details.

### Dual-zone automatic climate control air conditioner

N00731501513

Cooling or heating can only be performed when ready indicator is illuminating. When the operation mode of the power switch is ON, only the blower is available.

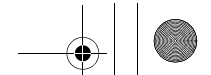

## Dual-zone automatic climate control air conditioner

### NOTE

- If the main drive lithium-ion battery level display indicates 0, the cooling performance cannot be obtained even the air conditioner is turned on.  
Refer to “Main drive lithium-ion battery level display screen” on page 5-147.
- If the engine cannot be started due to fuel shortage, etc., the heating performance cannot be obtained even the air conditioner is turned on.
- During charging the main drive lithium-ion battery, you can use the air conditioner.  
Refer to “How to use electric device during charging” on page 3-42.

7

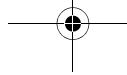

Comfort controls 7-5



## Dual-zone automatic climate control air conditioner

### Control panel

N00711801839

7

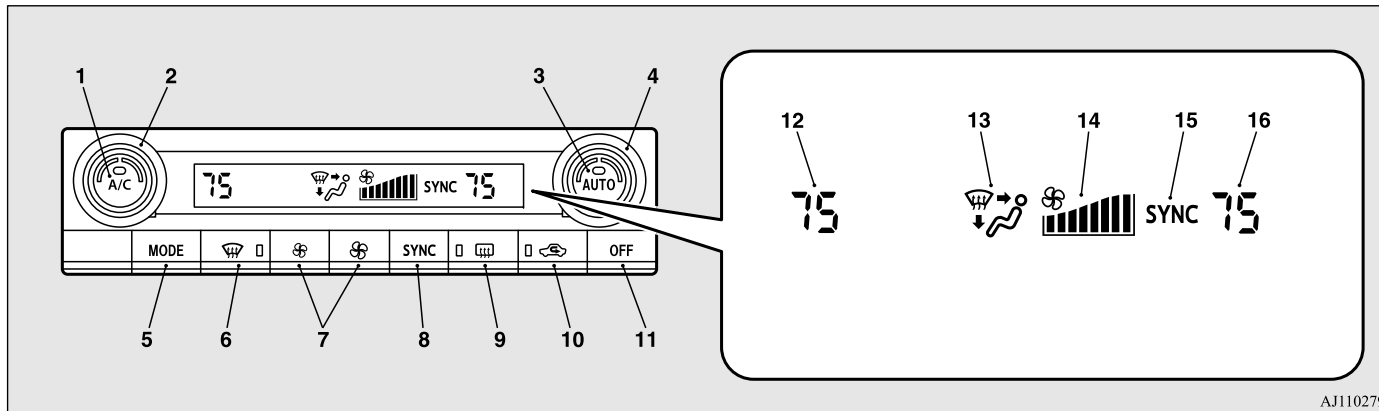

AJ1102791

- |  |   |
|--|---|
| 1- Air conditioning switch                           | 12- Driver's side temperature display<br>→ P.7-8    |
| 2- Driver's side temperature control dial            | 13- Mode selection display                          |
| 3- AUTO switch                                       | 14- Blower speed display                            |
| 4- Passenger's side temperature control dial         | 15- SYNC indicator                                  |
| 5- MODE switch                                       | 16- Passenger's side temperature display<br>→ P.7-8 |
| 6- Defogger switch                                   |   |
| 7- Blower speed selection switch                     |   |
| 8- SYNC switch                                       |   |
| 9- Electric rear window defogger switch<br>→ P.5-204 |   |
| 10- Air selection switch                             |   |
| 11- OFF switch                                       |   |

#### NOTE

- There is an interior air temperature sensor (A) in the illustrated position. Never place anything over the sensor, since doing so will prevent it from functioning properly.

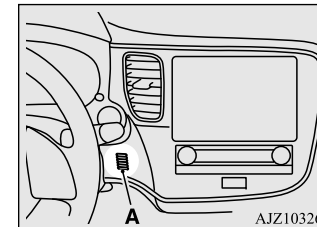

AJZ103261

### 7-6 Comfort controls

## Dual-zone automatic climate control air conditioner

### NOTE

- While EV priority mode is activated, except in pressing the defogger switch, engine does not start.  
Therefore, the heating performance may not be sufficiently obtained while EV priority mode is activated. In such case, cancel EV priority mode. Refer to “EV switch” on page 5-66.
- Since the air conditioning operation is controlled while the ECO mode is operating, you may feel that effectiveness of the air conditioner is insufficient. Refer to “ECO mode switch” on page 5-199.
- Even during ECO mode operation, you can select normal operation of the air conditioner.  
On vehicles equipped with the Smartphone-link Display Audio (SDA), screen operations can be used to change the setting. Refer to the separate owner’s manual for details.
- In extreme cold, the air conditioning control panel screen may operate sluggishly. This does not indicate a problem.  
It will disappear when the vehicle interior temperature rises to a normal temperature.

### Blower speed selection switch

N00736901310

Press the blower speed selection switch (1) to increase the blower speed.  
Press the blower speed selection switch (2) to decrease the blower speed.  
The selected blower speed (A) will be shown in the display.

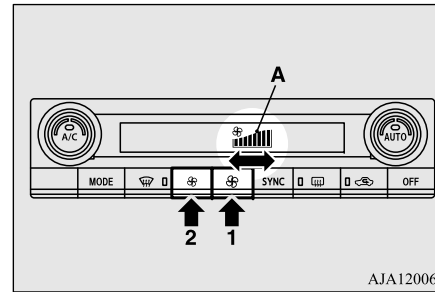

- 1- Increase
- 2- Decrease

### NOTE

- Due to a drop in the battery voltage or some other problem, the blower speed may temporarily become less than the selected blower speed display setting or the fan may stop.  
If the fan stops, put the operation mode to OFF, wait a few minutes, and then put the operation mode back to ON.  
In the following cases, have the system inspected by a certified Mitsubishi EV dealer.
  - The blower speed remains lower than the blower speed set using the blower speed display or the blower speed decreases frequently.
  - The fan does not operate even after stopping and restarting the Plug-in Hybrid EV System or the fan stops frequently.

7

## Dual-zone automatic climate control air conditioner

### Temperature control dial

N00737001565

Turn the temperature control dial clockwise to make the air warmer. Turn it counterclockwise to make the air cooler. The selected temperature (A) will be shown in the display.

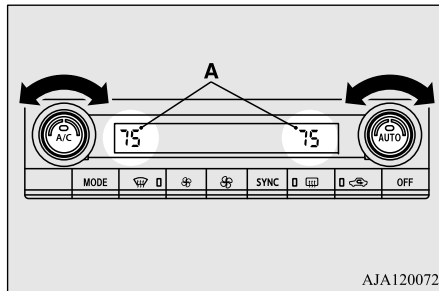

### NOTE

- The temperature value of air conditioner is switched in conjunction with outside temperature display unit of the multi-information display. Refer to “Changing the temperature unit” on page 5-156.

### NOTE

- When the engine coolant temperature is low, the air temperature from the heater will not change instantly, even if you have selected warm air with the switch. To prevent the windshield and windows from fogging up, the vent mode will be changed to “” and the blower speed will be reduced while the system is operating in the AUTO mode.
- When you feel that it is hotter or colder than the set temperature, you may adjust it to your preference. For further information, we recommend you to consult a certified Mitsubishi EV dealer.
- When the temperature is set to the highest or the lowest setting, the air selection and the air conditioner will be automatically changed as follows. Also, if the air selection is operated manually after an automatic changeover, manual operation will be selected.
  - Quick Heating (When the temperature is set to the highest setting) Outside air will be introduced and the air conditioner will stop.
  - Quick Cooling (When the temperature is set to the lowest setting) Inside air will be recirculated and the air conditioner will operate.

The above indicates the factory settings. You can personalize the air selection switch and

air conditioning switch to match your personal preferences.

Contact a certified Mitsubishi EV dealer for assistance.

Refer to “Personalizing the air conditioning switch (Changing the function setting)” on page7-12.

Refer to “Personalizing the air selection (Changing the function setting)” on page7-11.

### ■ To control the driver’s side and the passenger’s side temperature independently

When the “SYNC” indicator (A) goes off by turning the passenger’s side temperature control dial (B) or pressing the SYNC switch, the driver’s side and the passenger’s side temperature can be controlled independently.

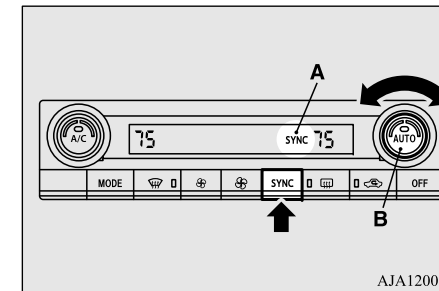



## Dual-zone automatic climate control air conditioner

### NOTE

- When the “SYNC” indicator (A) appears by pressing the SYNC switch, the passenger’s side temperature will be controlled to the same setting temperature as the driver’s side. While the “SYNC” indicator (A) is displayed, if the driver’s side temperature control dial (B) is turned, the passenger’s side setting temperature will be synchronized to the driver’s side.

### MODE switch

N00737101335

To change the amount of air flowing from the vents, press the MODE switch. Each time the MODE switch is pressed, the mode changes to the next one in the following sequence: “ ” → “ ” → “ ” → “ ” → “ ” → “ ”. The selected mode (A) is shown in the display. Refer to “Changing the mode selection” on page 7-3.

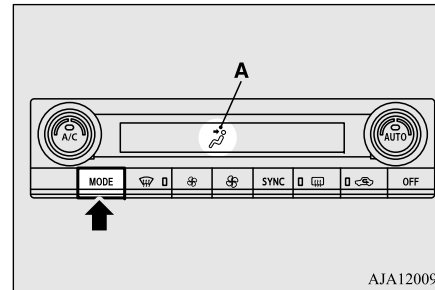

### Defogger switch

N00703401126

When this switch is pressed, the mode changes to the “ ” mode. The indicator light (A) will come on and the “ ” mode (B) is shown in the display.

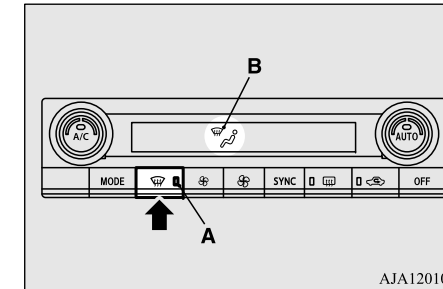

7

### NOTE

- When the defogger switch is pressed, the air conditioning system automatically operates and outside air (as opposed to recirculated air) is selected. This automatic switching control is carried out to prevent misting of the windows even if “Disable automatic air conditioning control” or “Disable automatic air selection control” is set. Refer to “Personalizing the air conditioning switch (Changing the function setting)” on page 7-12, “Personalizing the air selection (Changing the function setting)” on page 7-11.

## Dual-zone automatic climate control air conditioner

### NOTE

- To ensure a clear view, the engine may start when the defogger switch is pressed even while the EV priority mode is activated. Refer to “EV switch” on page 5-66.

7

### Air selection switch

N00737201525

Normally, use the outside air position to keep the windshield and side windows clear and to quickly remove fog or frost from the windshield.

To change the air selection, simply press the air selection switch.

- Outside air {Indicator light (A) OFF}  
Outside air is introduced into the passenger compartment.
- Recirculated air {Indicator light (A) ON}  
Air is recirculated inside the passenger compartment.

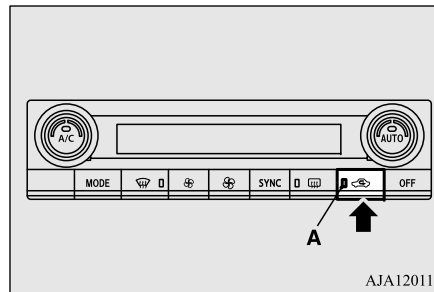

AJA120115

When the air conditioning turns on, the air selection is controlled automatically. When the air conditioning turns off, the air selection

automatically goes back to the outside position.

If high cooling performance is desired, or if the outside air is dusty or contaminated in some way, use the recirculation position. Switch to the outside position every now and then to keep the windows from fogging up.

### CAUTION

- Using recirculated air for a long time may cause the windows to fog up.

### NOTE

- If the mode selection is set to the “” position, you cannot turn the air conditioner off or select the recirculation position. This prevents the windows from fogging up.
- When the engine coolant temperature rises to a certain level, the air selection is automatically switched to the recirculation position and the indicator light (A) comes on. At this time, the system will not switch to the outside position even if the air selection switch is pressed.
- When the outside air temperature is high, the system will not switch to the outside position even when the air selection switch is pressed if the air conditioner is operating. This is to protect the air conditioner compressor and is not a failure.

## Dual-zone automatic climate control air conditioner

### ■ Personalizing the air selection (Changing the function setting)

N00712300081

You can change the following functions to match your preference.

- Enable automatic air selection control:  
When the AUTO switch is pressed, the air selection switch will also be automatically controlled.
- Disable automatic air selection control:  
Even when the AUTO switch is pressed, the air selection switch will not be automatically controlled.
- Changing the settings  
Press the air selection switch for approximately 10 seconds or longer.  
When the setting has changed, the system will beep and the indicator light (A) will flash.
  - When the setting has changed from enabled to disabled, the system will beep three times and the indicator light (A) will flash three times.
  - When the setting has changed from disabled to enabled, the system will beep two times and the indicator light (A) will flash three times.

On vehicles equipped with the Smart-phone-link Display Audio (SDA), screen operations can also be used to change the setting. Refer to the separate owner's manual for details.

#### NOTE

- The factory setting is “Enable automatic air selection control”.
- When the defogger switch is pressed, the air selection will automatically change to the outside air position, even if the system is set to “Disable automatic air selection control”, in order to prevent windows from fogging up.

### Air conditioning switch

N00737301539

Press the switch, and the air conditioning compressor will turn on. The indicator light (A) will come on.

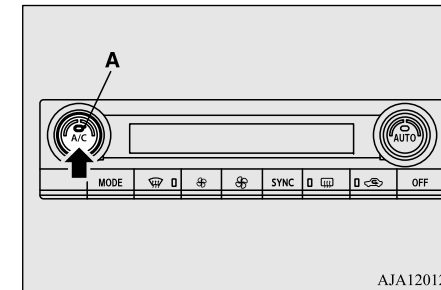

Press the switch again and the air conditioning compressor will stop and the indicator light (A) goes off.

#### NOTE

- If a problem is detected in the air conditioning compressor, the indicator light (A) blinks. Press the air conditioning switch once to turn it off, then once more to turn it back on. If the indicator light (A) does not blink, there is no problem. If it continues to blink, have it checked at a certified Mitsubishi EV dealer.

## Dual-zone automatic climate control air conditioner

### NOTE

- For example, sometimes after using a high-pressure car wash, the condenser can get wet, and the indicator light (A) blinks temporarily. Wait for a while, press the air conditioning switch once to turn the system off, then once more to turn it back on. Once the water evaporates, the blinking will stop.

### 7 ■ Personalizing the air conditioning switch (Changing the function setting)

N00712200110

You can change the following functions to match your preference.

- Enable automatic air conditioning control:  
When the AUTO switch is pressed, or when the temperature control dial has been set to the minimum temperature, the air conditioning switch is automatically controlled.
- Disable automatic air conditioning control:  
The air conditioning switch is not automatically controlled, unless the air conditioning switch is used.
- Changing the settings  
Press the air conditioning switch for approximately 10 seconds or longer.

### 7-12 Comfort controls

When the setting has changed, the system will beep and the indicator light (A) will flash.

- When the setting has changed from enabled to disabled, the system will beep three times and the indicator light (A) will flash three times.
- When the setting has changed from disabled to enabled, the system will beep two times and the indicator light (A) will flash three times.

On vehicles equipped with the Smart-phone-link Display Audio (SDA), screen operations can also be used to change the setting. Refer to the separate owner's manual for details.

### NOTE

- The factory setting is "Enable automatic air conditioning control".
- When the defogger switch is pressed, the air conditioner will run automatically, even if the system is set to "Disable automatic air conditioning control", in order to prevent windows from fogging up.

### AUTO switch

N00703501101

When the AUTO switch is pressed, the indicator light (A) comes on and the mode selection, blower speed adjustment, recirculated/outside air selection, temperature adjustment, and air conditioner ON/OFF status are all controlled automatically. The selected mode and the blower speed are not shown in the display.

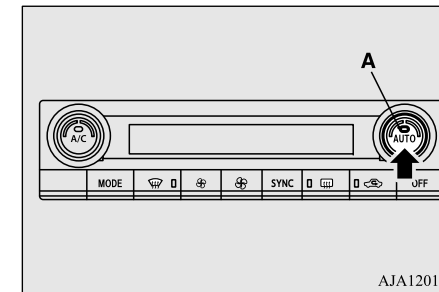

AJA120131

Dual-zone automatic climate control air conditioner

**OFF switch**

N00703601085

Press the OFF switch to turn off the air conditioning system.

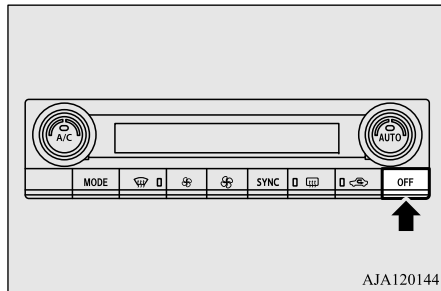

**Operating the air conditioning system (automatic mode)**

N00731701658

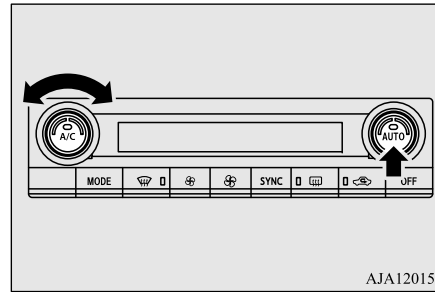

In normal conditions, use the system in the AUTO mode and follow these procedures:

1. Press the AUTO switch.
2. Set the temperature control dial to the desired temperature. The temperature can be set within a range of around 61 (LO) to 89 (HI) (when the outside temperature unit of the multi-information display shows °F) or 17 (LO) to 31 (HI) (when the outside temperature unit of the multi-information display shows °C).

The vents, recirculation/outside air, blower speed, temperature adjustment, and ON/OFF of air conditioner will be controlled automatically.

**NOTE**

- Set the temperature at approximately 75 (when the outside temperature unit of the multi-information display shows °F) or 24 (when the outside temperature unit of the multi-information display shows °C) under normal conditions.
- When the engine coolant temperature is low, the air temperature from the heater will not change instantly, even if you have selected warm air with the temperature dial. To prevent the windshield and windows from fogging up, the vent mode will be changed to "☁" and the blower speed will be reduced.

7

**Operating the air conditioning system (manual mode)**

N00731801125

Blower speed and vent mode may be controlled manually by setting the blower speed selection switch and the MODE switch to the desired positions. To return to automatic operation, press the AUTO switch.

**Defrosting or defogging (windshield, door windows)**

N00732401678

**CAUTION**

- For safety, make sure you have a clear view through all the windows.

### Important air conditioning operating tips

To remove frost or mist from the windshield and door windows, use the MODE switch or defogger switch (“” or “”).

#### ■ For ordinary defrosting

Use this setting to keep the windshield and door windows clear of mist, and to keep the leg area heated (when driving in rain or snow).

7

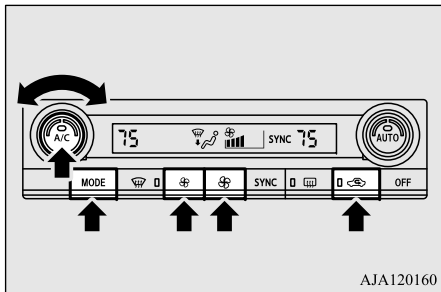

1. Set the air selection switch to the outside position.
2. Set the MODE switch to the “” position.
3. Select your desired blower speed by pressing the blower speed selection switch.
4. Select your desired temperature by turning the temperature control dial.
5. Press the air conditioning switch.

7-14 Comfort controls

#### ■ For quick defrosting

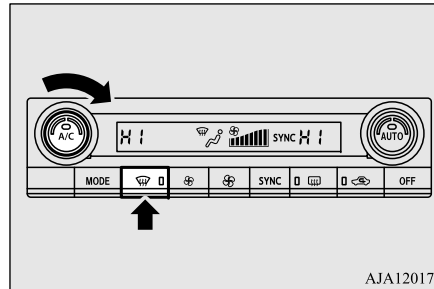

1. Press the defogger switch.
2. Set the temperature to the highest position.

#### NOTE

- While the “” indicator light is on, the air conditioning compressor will run automatically. The outside air position will also be selected automatically.
- If the “” indicator light is on, you cannot turn the air conditioner off or select the recirculation position. This prevents the windows from fogging up.
- To defog quickly, direct the air flow from the side vents toward the door windows.
- When defrosting, do not set the temperature to the maximum cool position. This will blow cool air on the window glass and fog it up.

### Important air conditioning operating tips

N00733701447

- Park the vehicle in the shade whenever possible. Parking in the hot sun makes the vehicle interior extremely hot which then requires more time to cool. If it is necessary to park in the sun, open the windows for the first few minutes of air conditioning to expel the hot air. Afterwards, keep the windows closed when the air conditioner is in use. The entry of outside air through open windows will reduce cooling efficiency.
- When running the air conditioner, make sure the air intake, which is located in front of the windshield, is free of obstructions such as leaves. Leaves collected in the air-intake chamber may reduce air flow and plug the water drains.
- Too much cooling/heating can affect the EV cruising range, so maintain an appropriate temperature to extend the EV cruising range.

## Air conditioning system refrigerant and lubricant recommendations

If the air conditioner seems less effective than usual, the cause might be a refrigerant leak. Have the system inspected by a certified Mitsubishi EV dealer.

### CAUTION

- The air conditioning system in your vehicle must be charged with the refrigerant HFO-1234yf and the lubricant POE MA68EV. Use of any other refrigerant or lubricant will cause severe damage and may require replacing your vehicle's entire air conditioning system.
- The release of refrigerant into the atmosphere is not recommended.
- The new refrigerant HFO-1234yf in your vehicle is designed not to harm the earth's ozone layer. Additionally, it has a significantly reduced global warming impact on the environment, compared to the refrigerant HFC-134a.

## During a long period of disuse

The air conditioner should be operated for at least five minutes each week, even in cold

weather. This includes the quick defrosting mode. Operating the air condition system weekly maintains lubrication of the compressor internal parts to keep the air conditioner in the best operating condition.

## Air purifier

N00733801204

The air conditioning system is equipped with an air filter to remove pollen and dust. The air filter's ability to collect pollen and dirt is reduced as it becomes dirty, so replace it periodically. For the maintenance interval, refer to the "WARRANTY AND MAINTENANCE MANUAL".

### NOTE

- Operation in certain conditions such as driving on a dusty road and frequent use of the air conditioner can lead to reduction of service life of the filter. When you feel that the air flow is lower than normal or when the windshield or windows start to fog up easily, replace the air filter. Contact a certified Mitsubishi EV dealer for assistance.

## Air purifier

## Remote Climate Control (if so equipped)

N00766601039

You can run the air conditioner in advance of using the vehicle.

For details, refer to "MITSUBISHI Remote Control" on page 3-38.

## Heating

N00766700033

7

When heating, the engine starts running because the heating system uses the heat of engine coolant.

As your vehicle is equipped with electric heater, it can reduce the number of times that the engine starts since power stored in the lithium-ion battery is used when heating the vehicle's interior.

### NOTE

- If the ambient temperature is low, the engine may start for heating when the Plug-in Hybrid EV system is started with the air conditioner performed. If you want to stop the engine running, select the EV priority mode with the operation mode of the power switch in ON before starting the Plug-in Hybrid EV system. Refer to "EV switch" on page 5-66.

## General information about your radio

### General information about your radio

N00733901553

Your vehicle's radio receives both AM and FM stations.

The quality of your reception is affected by distance, obstacles, and signal interference.

**7**

This radio complies with Part 15 of Federal Communications Commission (FCC) Rules (for vehicles sold in U.S.A.). Operation is subject to the following conditions:

- The device may not cause harmful interference.
- This device must accept any interference received, including interference that may cause undesirable operation.

#### **CAUTION**

- Changes or modifications not expressly approved by the party meeting the above conditions could void the user's authority to operate the equipment.

### Signal transmission

FM signals do not follow the earth surface nor are they reflected by the upper atmosphere. For this reason, FM broadcasts cannot be received over long distances. AM signals follow the earth's surface and are reflected by the upper atmosphere. For this reason, AM broadcasts can be received over longer distances.

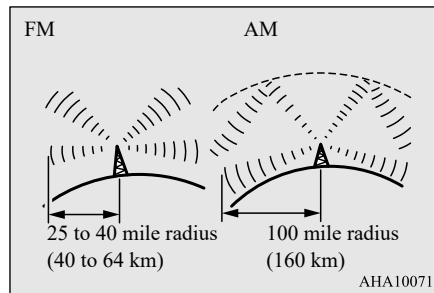

### Weak reception (fading)

Because of the limited range of FM signals and the way FM waves transmit, you may experience weak or fading FM reception. When the broadcast is blocked by mountains or similar obstructions, reception can be disturbed.

### Reflection

The reason why one can hear FM but not AM in parking garages, under bridges etc., is that FM signals, unlike AM signals, are reflected by solid objects such as buildings, etc.

Because FM signals are easily reflected by buildings, this can also cause reception disturbances.

The direct signal from the broadcast station reaches the antenna slightly before the reflected signal. This time difference may cause some reception disturbance or flutter.

This problem occurs primarily in urban areas.

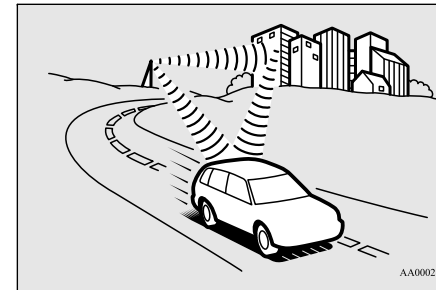



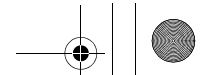

### Cross modulation

If one listens to a weak station and is in the vicinity of another strong station, both stations might be received simultaneously.

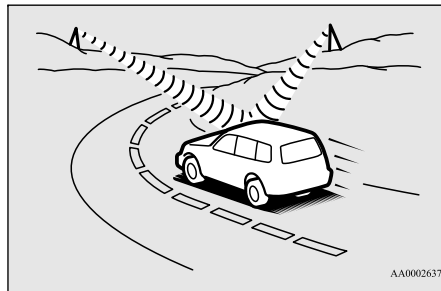

### Causes of disturbances

FM reception is affected by the electrical systems of vehicles in the vicinity, especially those without an electronic noise suppression device. The disturbance is even greater if the station is weak or poorly tuned.

FM reception is not as sensitive to electrical disturbances as AM. AM reception is sensitive to electrical disturbances such as power lines, lightning and other types of similar electrical phenomena.

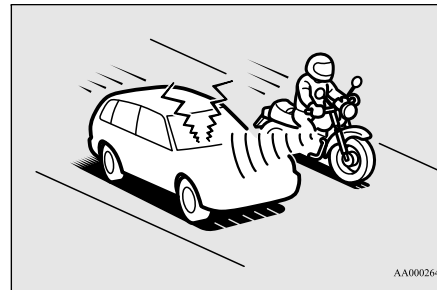

### FM stereo reception

Stereo reception requires a high quality broadcast signal. This means that types of disturbances mentioned previously become more marked and the reception range is somewhat diminished during stereo reception.

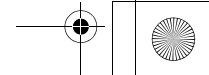
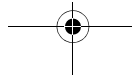



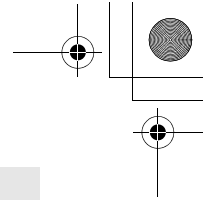
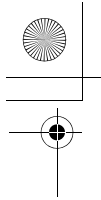

# *For emergencies*

- If the vehicle breaks down .....8-2
- If the operation mode cannot be changed to OFF .....8-2
- Jump-starting the Plug-in Hybrid EV system .....8-2
- Engine overheating .....8-4
- Jack and tools .....8-6
- Tire repair kit .....8-7
- How to change a tire .....8-14
- Towing .....8-17
- Operation under adverse driving conditions .....8-19
- Fuel Pump Shut-off System .....8-20

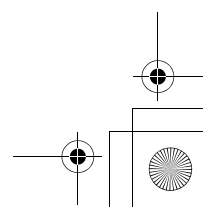
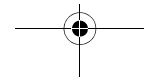
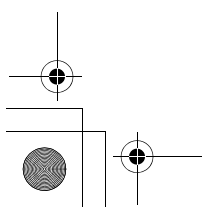
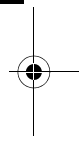
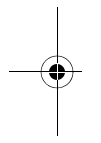

## If the vehicle breaks down

### If the vehicle breaks down

N00836301256

If your vehicle breaks down on the road, move to the shoulder and turn on the hazard warning lights. If there is no shoulder, or the shoulder is not safe, drive in the right lane slowly, with the hazard warning lights flashing, until you come to a safe stopping place. Keep the hazard warning lights flashing.

8

#### ⚠ WARNING

- If you are unable to safely assess the vehicle due to vehicle damage, do not touch the vehicle.

Leave the vehicle and contact emergency services. Advise emergency responders that this is a Plug-in Hybrid Electric vehicle.

### If the ready indicator goes out while driving

There will be no power assist to the steering and brakes, making these difficult to use.

- The brake booster will not work, so the brakes will not grip well. The brake pedal will be harder to press than usual.

8-2 For emergencies

- Since there is no power steering assist, the steering wheel will be hard to turn.

### When the ready indicator goes off at the intersection

Get help from your passengers, bystanders, etc. to push your vehicle and move it to a safe area and turn on the hazard warning lights.

When you move the vehicle, put the operation mode of the power switch in ON and put the select position in the “N”(NEUTRAL) position.

### If the operation mode cannot be changed to OFF

N00860700074

If the operation mode cannot be changed to OFF, perform the following procedure.

1. Put the select position in “P” (PARK) position, and then change the operation mode to OFF.
2. One of the other causes could be low 12 V starter battery voltage.

If this occurs, the keyless entry system and the F.A.S.T.-key operation will also not operate. Contact a certified Mitsubishi EV dealer.

### Jump-starting the Plug-in Hybrid EV system

N00836401866

If the Plug-in Hybrid EV system cannot be started because the 12 V starter battery is weak or dead, you can start it with the battery from another vehicle using jumper cables.

#### ⚠ WARNING

- To reduce the risk of igniting flammable gas that may be emitted from the battery, carefully read this section before jump-starting the vehicle.
- Do not try to start your vehicle by pushing or towing. This can cause an accident resulting in serious injury or death and can damage the vehicle.

#### ⚠ CAUTION

- Do not attempt jump starting the 12 V starter battery while the main drive lithium-ion battery is being charged. Doing so could damage the vehicle or charging equipment.

#### 📖 NOTE

- Do not use jumper cables if they have damage or corrosion.

## Jump-starting the Plug-in Hybrid EV system

1. Take off any metal jewelry such as watch bands or bracelets that might create an accidental electrical contact.
2. Position the vehicles close enough together so that the jumper cables can reach, but be sure the vehicles aren't touching each other.

### CAUTION

- Check the other vehicle. It must have a 12-volt battery. If the other system isn't 12-volt, both systems can be damaged.

3. Set the parking brake firmly on your vehicle and put the select position in the "P" (PARK) position.
4. Set the parking brake firmly on the other vehicle. Put the automatic transaxle in "P" (PARK) or the manual transaxle in "N" (Neutral).
5. Turn the ignition switch (the power switch) on each vehicle to the "LOCK" or "OFF" position.

### NOTE

- Turn off all lights, heater, and other electrical loads. This will avoid sparks and help save both batteries.

6. Open the engine hood, remove the fuse cover of the main fuse block.

Refer to "Engine hood" on page 9-4 and "Fuses: Engine compartment" on page 9-24.

7. Open the cover of the jumper cable terminal in the main fuse block.

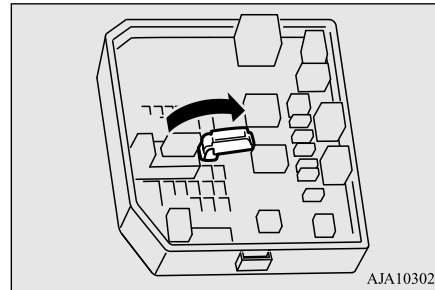

### NOTE

- You cannot rescue other vehicle's discharged battery by connecting jumper cables using this jumper cable terminal.

8. Connect one end of one jumper cable ① to the jumper cable terminal (A) of your vehicle, and the other end ② to the positive (+) terminal of the booster battery (B).  
Connect one end of the other jumper cable ③ to the negative (-) terminal of the booster battery, and the other end ④ to the designated ground location of your vehicle.

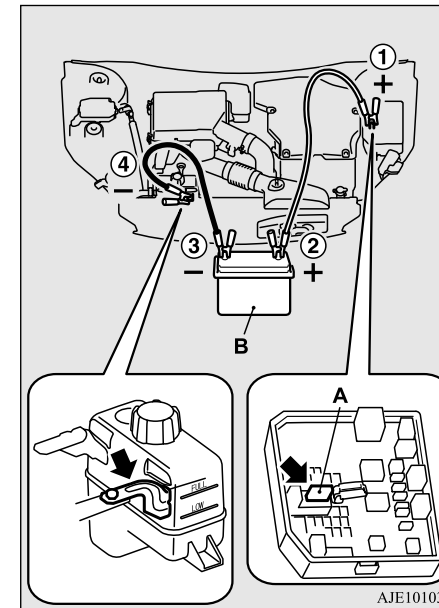

8

## Engine overheating

### WARNING

- Be sure to follow the proper order when connecting the jumper cable, of:  
①→②→③→④
- Make sure that the connection ④ is made to the correct designated location (as shown in the illustration) properly. If the connection is directly made to the negative (-) terminal of the battery, the flammable gases from inside the battery might catch fire and explode, causing personal injury.
- When connecting the jumper cable, do not connect the positive (+) cable to the negative (-) terminal. Sparks can make the battery explode.
- Use care not to get the jumper cable caught in the cooling fan or any other rotating part in the engine compartment.

8

### NOTE

- If the jumper cable is connected to any position other than appointed position, it could cause damage to the vehicle.
- Use the power cables suitable for the battery size. Otherwise heat damage to the cables could result.

9. Start the engine in the vehicle providing the boost. Let the engine idle a few minutes, then start the Plug-in Hybrid EV system in your vehicle.

8-4 For emergencies

10. Check that the ready indicator illuminates. If the ready indicator does not illuminate, contact a certified Mitsubishi EV dealer.
11. When the ready indicator illuminates, disconnect the jumper cables in the reverse order from the way you connected them.
12. Check that the select position can be shifted to all positions other than the “P” (PARK) position.
13. Have the 12 V starter battery inspected by your nearest a certified Mitsubishi EV dealer.

### CAUTION

- Your vehicle is equipped with an exclusive 12 V starter battery. Even if the battery type is the same, the battery may not be correctly installed in your vehicle. When replacing the 12 V starter battery, request a certified Mitsubishi EV dealer.

### As your vehicle has anti-lock brakes

If you drive your vehicle with a low battery charge after the Plug-in Hybrid EV system has been started by using jumper cables, it can cause the anti-lock braking system warning light to illuminate. This is only due to the low battery voltage. It is not a problem with

the brake system. If this happens, fully charge the 12 V starter battery and ensure the charging system is operating properly.

### Engine overheating

N00836501434

When the engine is overheating, the following warning display will appear on the information screen in the multi-information display.

Warning display



If this warning is displayed:

1. Stop the vehicle in a safe place. Turn on the hazard warning lights.
2. With the Plug-in Hybrid EV system still running, carefully raise the engine hood to vent the engine compartment.
3. Check that the cooling fan (A) is running. If the fan is not turning, stop the Plug-in Hybrid EV system immediately and contact a certified Mitsubishi EV dealer for assistance.

### Engine overheating

**⚠ WARNING**

- To avoid personal injury, keep hands, hair, jewelry and clothes away from the cooling fan. The cooling fan can start at any time.

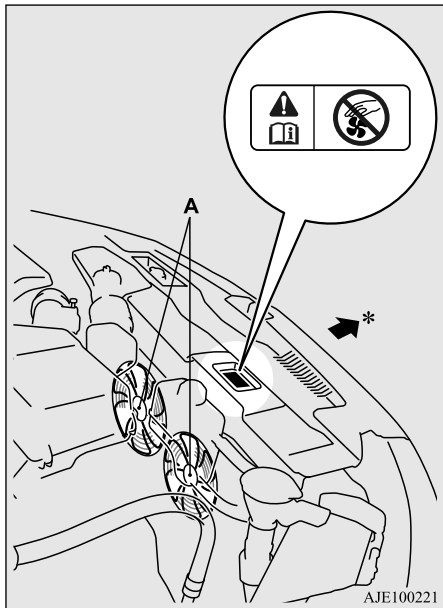

\*: Front of the vehicle

4. If you see steam or spray coming from under the hood, stop the Plug-in Hybrid EV system.

5. If you do not see steam or spray coming from under the hood, leave the Plug-in Hybrid EV system on until the high coolant temperature warning goes off. After the high coolant temperature warning has gone off, you can start driving again. If the high coolant temperature warning stays on, turn off the Plug-in Hybrid EV system.

**⚠ WARNING**

- Before raising the engine hood, check to see if there is steam or spray coming from under the hood. Steam or spray coming from an overheated engine could seriously scald you. Do not open the hood until there is no steam or spray.

6. When you do not see any more steam or spray, open the hood. Look for obvious leaks, such as a split radiator hose. Be careful as components will be hot. Any leak source must be repaired.

7. If there is no obvious leak source, check the coolant level in the coolant reserver (B and C). If there is none, or if it is too low, slowly add coolant.

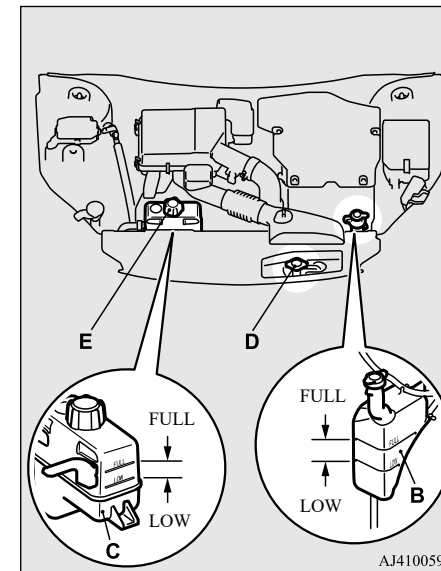

B: Reserve tank for engine cooling  
C: Reserve tank for EV cooling system

## Jack and tools

8. If the coolant reservoir tank needs coolant, you will probably also need to add coolant to the radiator. Do not loosen or remove the radiator cap (D) and the reservoir cap (E) until the Plug-in Hybrid EV system has cooled down.

### ⚠ WARNING

● Removing the radiator cap and the reserve cap could scald you with escaping hot water or steam. When checking the radiator level, cover the cap with a cloth before trying to remove it. Turn it slowly counterclockwise, without pressing down, to the first notch. The pressure in the system will then be let out. When the pressure is COMPLETELY LET OUT, press down and keep turning the cap counterclockwise until it comes off.

8

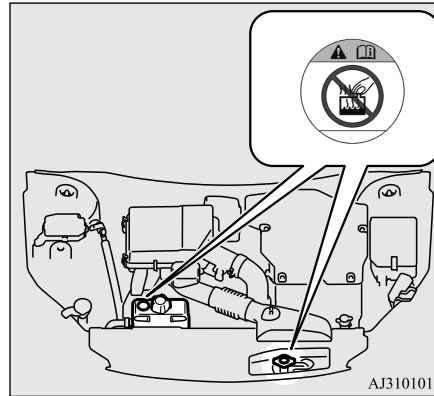

9. Start the Plug-in Hybrid EV system, and slowly add coolant, up to the bottom of the filler neck. Use plain water if you have to (and replace it with the right coolant as soon as possible).
10. Replace the radiator cap and tighten it fully. You can start driving again when the high coolant temperature warning does not come on.
11. Have the system inspected by your certified Mitsubishi EV dealer.

## Jack and tools

N00836601406

## Storage

The tools are stowed back of the interior trim lid in the cargo area.

The jack is stowed in the luggage floor box.

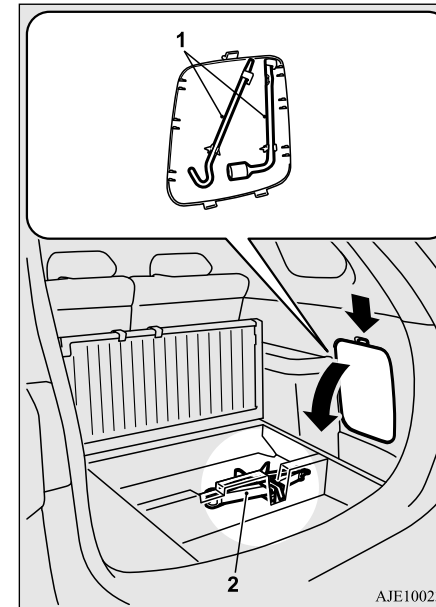

1- Tools



## Tire repair kit

### 2- Jack

#### Tools

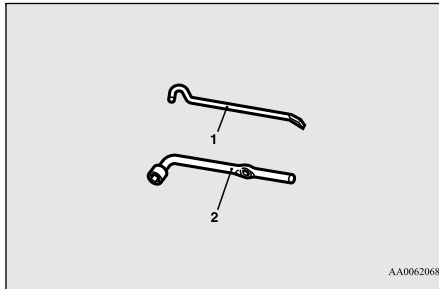

- 1- Bar
- 2- Wheel nut wrench

2. Remove the band (A) and take out the jack.

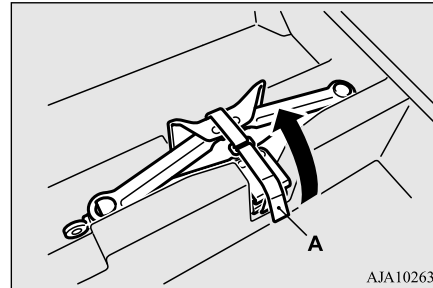

#### To store

Perform the removal steps in reverse.

#### Removing and storing the jack

#### To remove

1. Raise the luggage floor board.  
Refer to “Luggage floor box” on page 5-225.

#### ⚠ WARNING

- Using the tire repair kit may damage the wheel and/or the tire inflation pressure sensor for the tire. The vehicle must promptly be inspected and repaired by a certified Mitsubishi EV dealer after using the tire repair kit.
- Use only the Mitsubishi Motors genuine tire repair kit. Sealant in other repair kits may not sufficiently seal the tire puncture.

#### Tire repair kit

N00800401025

The tire repair kit can be used to temporarily repair a minor puncture in tread area caused by a nail, screw or similar object. Therefore, a spare tire is not provided.

#### ⚠ WARNING

- The tire repair kit may not permanently seal a punctured tire. Have the tire repaired as soon as possible.

## Tire repair kit

### Tire repair kit storage

N00800501055

The tire repair kit is stored beneath the floor board of the cargo area.

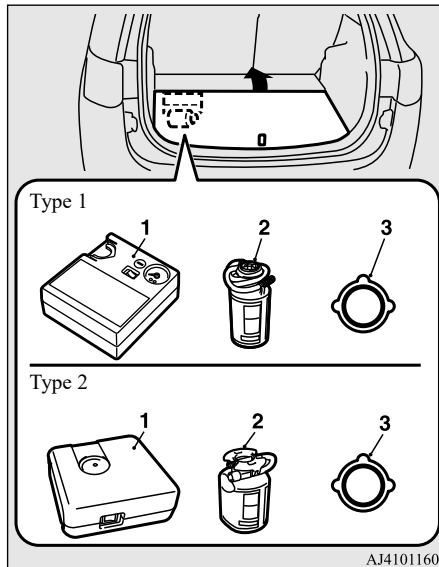

Tire repair kit which consists of 1 to 3.

- 1- Tire compressor
- 2- Tire sealant bottle
- 3- Speed restriction sticker

### How to use the tire repair kit

N00800601069

#### ⚠ WARNING

- Never use the tire repair kit under in any of the situations listed below. The tire cannot be repaired by the tire repair kit. If any of these situations occurs, please contact a certified Mitsubishi EV dealer.
- More than one tire is punctured.
- The puncture hole has a length or width of 1/7 inch (4 mm) or greater.
- The tire is punctured in the side wall (A), not in the tread (B).

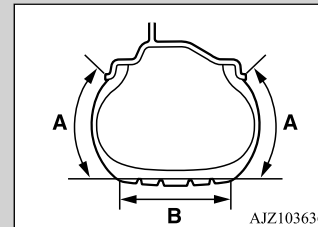

- The vehicle has been driven with the tire almost completely flat.
- The tire has completely slipped over the wheel rim and come off the wheel.
- The wheel is damaged.
- A bump, cut or crack is on the tire.

#### ⚠ WARNING

- The tire sealant's expiration date has passed. (The expiration date is shown on the bottle label (C).)

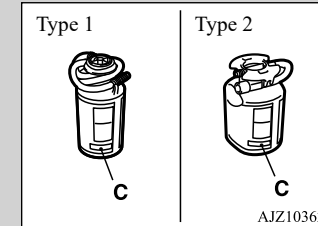

- The ambient temperature is below -40 °F (-40 °C) or above 140 °F (60 °C).
- The tire sealant can cause health damage if swallowed. If you accidentally swallow it, drink as much water as possible and immediately seek medical attention.
- If the tire sealant gets in your eyes or on your skin, rinse it away with lots of water. If you still sense an abnormality, seek medical attention.
- Consult a doctor immediately if any allergic reactions occur.
- Do not allow children to touch the tire sealant.

#### ⚠ CAUTION

- If the vehicle body is contaminated by the tire sealant, wipe the tire sealant off immediately with a wet cloth.

## Tire repair kit

### ⚠ CAUTION

- Immediately wash clothes contaminated with tire sealant. The tire sealant may not be removed from the clothes.

### 📖 NOTE

- Do not pull out an object, such as a nail or screw, that penetrates the punctured tire.
- Move the vehicle so that the tire valve is positioned away from the point where the tire touches the ground. If the valve is near the point where the tire touches the ground, the sealant may not enter the tire easily.
- Check the tire sealant's expiration date regularly, and be sure to purchase a new one from a certified Mitsubishi EV dealer before the expiration date.

1. Park the vehicle on a safe, flat and level place.
2. Set the parking brake firmly.
3. Put the select position in "P" (PARK) position and stop the Plug-in Hybrid EV system.
4. Turn on the hazard warning lights and set up a warning sign, such as a warning triangle or flashing signal lamp, at an adequate distance from the vehicle, and have all your passengers leave the vehicle.
5. Take out the tire repair kit.

Make sure that the compressor switch is OFF.

6. Shake the tire sealant bottle well.

Example type 1

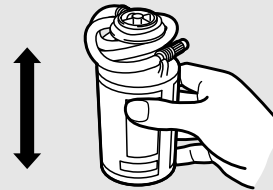

### 📖 NOTE

- In cold conditions (when the ambient temperature is 32 °F {0 °C} or lower), thickening of the tire sealant can make the tire sealant hard to squeeze out of the bottle. Warm the bottle between your hands inside the vehicle.

7. Take the valve cap (D) off the tire valve (E).

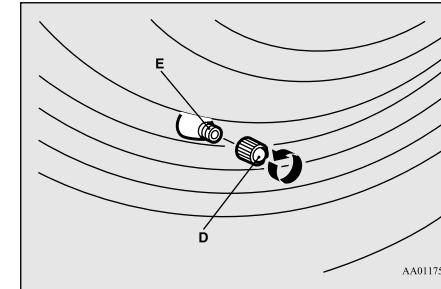

8

For emergencies 8-9

### Tire repair kit

8. On vehicles with Type 2 tire repair kit, remove the rubber cap (F) from the free end of the bottle hose. Unwind the bottle hose (G) from around the sealant bottle.

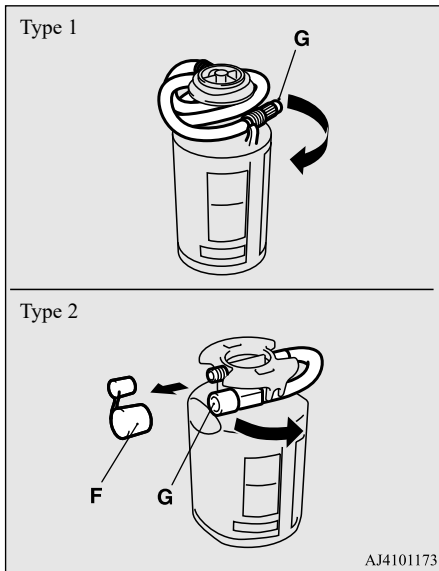

8

9. Pull out the compressor's hose (H) from the compressor and securely attach it to the valve (I) of the bottle by turning it clockwise until tight.

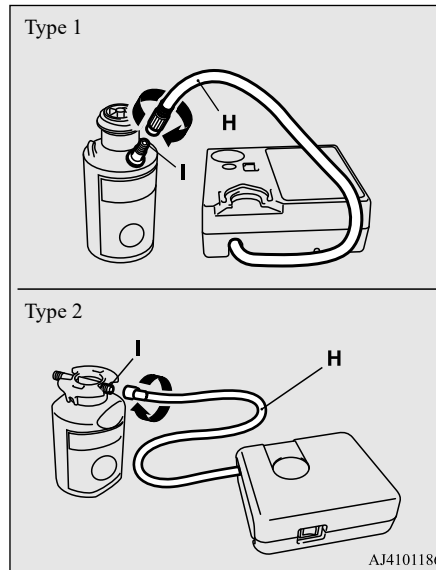

10. On vehicles with Type 1 tire repair kit, install the bottle onto the compressor.

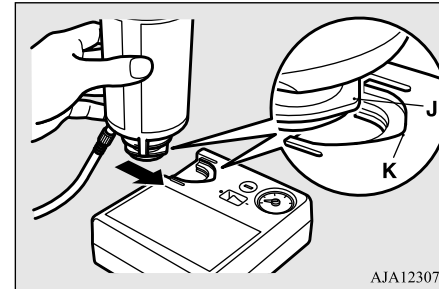

#### NOTE

- When installing the bottle, align the projection (J) on the bottle with the indentation (K) in the compressor.

11. Securely attach the bottle hose (G) to the tire valve (E).

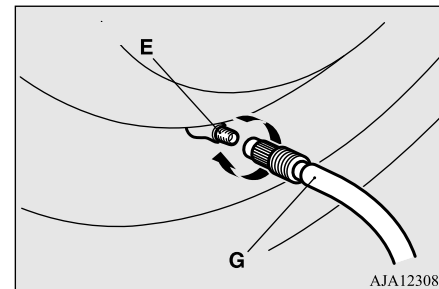

Tire repair kit

**CAUTION**

- If the bottle hose is not attached securely, the tire sealant will leak out from the tire valve and the tire may not inflate to the specified pressure.

12. Pull out the compressor's power cord (L), insert the plug on the cord into the 12 V power outlet (M), and then put the operation mode of the power switch in ACC. (Refer to "12V power outlet" on page 5-209.)

Turn ON the compressor switch (N) and inject all of the tire sealant and inflate the tire to the specified pressure. (Refer to "Tire inflation pressures" on page 9-17.) If there is a gap between the tire and wheel, push the tread area toward the center of the wheel to close the gap before running the compressor.

Type 1

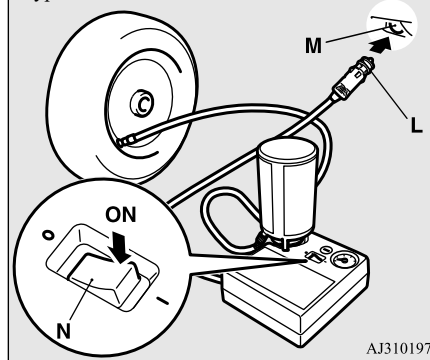

Type 2

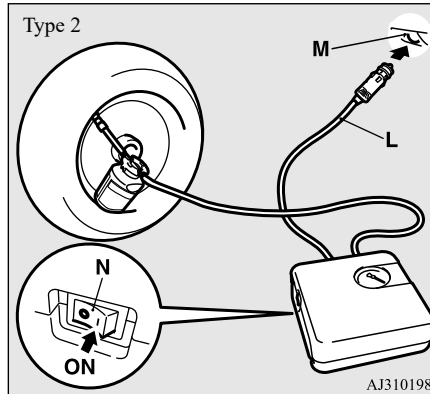

**WARNING**

- Do not place your hand or fingers between the tire and wheel while inflating the tire. Your hand or fingers may become caught between the tire and wheel.

**CAUTION**

- The supplied compressor is designed only for inflation of your vehicle tires.
- The compressor is designed to run on a vehicle's 12 V power supply. Do not connect it to any other power source.
- The compressor is not waterproof. If you use it in rain, make sure water does not get on it.
- Any sand or dust sucked into the compressor could make the compressor break down. Do not place the compressor directly on any sandy or dusty surface when using it.
- Do not disassemble or modify the compressor. Also, do not subject the air pressure gauge to shock. It could malfunction.

**NOTE**

- On vehicles with Type 2 tire repair kit, be careful not to turn the tire sealant bottle upside down.

## Tire repair kit

13. Affix the speed restriction sticker (O) to the three-diamond mark on the steering wheel.

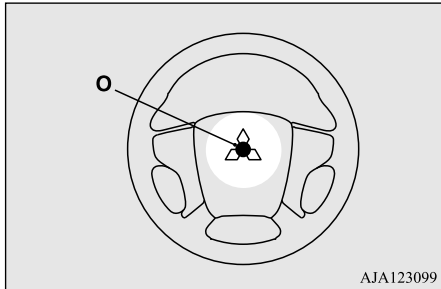

8

### CAUTION

- Do not affix the sticker anywhere except the specified position on the pad of the steering wheel. Affixing the sticker in an incorrect position could prevent the SRS airbag from deploying properly.

14. Check and adjust the tire pressure with reference to the air pressure gauge on the compressor.

On vehicles with Type 1 tire repair kit, if you overinflate the tire, release air by pressing the pressure release switch (P) on the compressor.

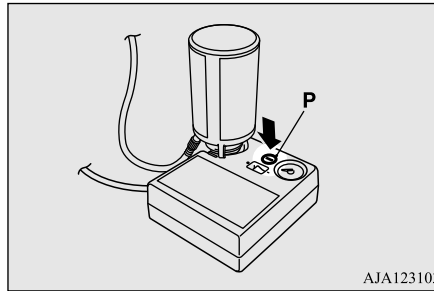

### CAUTION

- The surface of the compressor will get hot while the compressor is running. Do not keep the compressor running continuously for more than 10 minutes. After using the compressor, wait for the compressor to cool before using it again.
- If the compressor becomes sluggish or hot while operating, it is overheating. Immediately place the switch in the OFF position and let the compressor cool down for at least 30 minutes.

### CAUTION

- On vehicles with Type 1 tire repair kit, do not press the pressure release switch (P) while sealant is being injected, because the sealant may leak from compressor.

### NOTE

- If the tire pressure does not rise to the specified level within 10 minutes, the tire may be so severely damaged that the tire sealant cannot be used for emergency repair. Do not drive the vehicle. Please contact a certified Mitsubishi EV dealer.

15. Turn OFF the compressor switch, then pull the power cord plug out of the 12 V power outlet.

### NOTE

- At this point the puncture hole is not sealed yet. Air will continue to leak through the puncture hole until the emergency repair procedure is completed (through step 17 or step 18 of these instructions).

16. When you have inflated the tire to the specified pressure, stow the compressor and bottle in the vehicle and promptly start driving the vehicle so that the tire sealant can spread evenly in the tire. Drive with great care. Do not exceed a speed of 50 mph (80 km/h). Observe local speed limits.

**CAUTION**

- If you sense any abnormality while driving, stop the vehicle and contact a certified Mitsubishi EV dealer. Otherwise the tire pressure may drop before the emergency repair procedure is completed, rendering the vehicle unsafe to drive.

17. After driving for 10 minutes or 3 miles (5 km), park the vehicle in a safe place. Remove the air compressor from the stowed position. Check the tire pressure using the air pressure gauge on the compressor. If the tire pressure has not dropped, the emergency repair procedure is complete. Proceed to step 19. If the tire pressure is insufficient, inflate the tire to the specified pressure again and drive the vehicle carefully without exceeding a speed of 50 mph (80 km/h). Before driving, make sure that the compressor is stowed.

**CAUTION**

- If the tire pressure is lower than the minimum permitted pressure (18 psi {130 kPa}), the tire cannot successfully be repaired with the tire sealant. Do not drive the vehicle any further. Contact a certified Mitsubishi EV dealer.

18. After driving for 10 minutes or 3 miles (5 km) again, check the tire pressure using the air pressure gauge on the compressor. If the tire pressure has not dropped, the emergency repair procedure is complete. Before driving, make sure that the compressor is stowed. You must still not exceed a speed of 50 mph (80 km/h). Observe local speed limits.

**NOTE**

- If the tire pressure has dropped below the specified level when you check it at the end of the repair procedure, do not drive the vehicle any further. Contact a certified Mitsubishi EV dealer.

**NOTE**

- In cold conditions (when the ambient temperature is 32 °F {0 °C} or lower), the time and driving distance required until completion of the repair can become longer than in warmer conditions, and the tire pressure may drop below the specified level even after you have inflated the tire the second time and subsequently driven the vehicle. If this happens, inflate the tire to the specified pressure once more, drive for approximately 10 minutes or 3 miles (5 km), then check the tire pressure again. If the tire pressure has again dropped below the specified level, stop driving the vehicle and contact a certified Mitsubishi EV dealer.

19. Immediately drive with great care to a certified Mitsubishi EV dealer and have the tire repair/replacement performed.

**NOTE**

- Please give the empty sealant bottle to a certified Mitsubishi EV dealer or dispose of the sealant bottle according to regulations for the disposal of chemical waste.
- To purchase a new tire sealant bottle, contact a certified Mitsubishi EV dealer.

## How to change a tire

### How to change a tire

N00836901874

Before changing a tire, first stop your vehicle in a safe, flat location.

1. Park the vehicle on level and stable ground.
2. Set the parking brake firmly.
3. Put the select position in "P" (PARK) position and stop the Plug-in Hybrid EV system.
4. Turn on the hazard warning lights and set up a warning sign, such as a warning triangle or flashing signal lamp, at an adequate distance from the vehicle, and have all your passengers leave the vehicle.
5. To prevent the vehicle from rolling when it is raised on the jack, place chocks or blocks (A) at the tire that is diagonally opposite from the tire (B) you are changing.

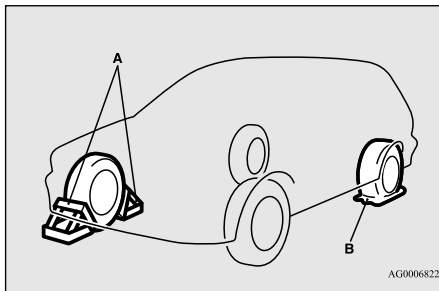

8-14 For emergencies

### WARNING

- Be sure to apply chocks or blocks to the correct tire when jacking up the vehicle. If the vehicle moves while jacked up, the jack could slip out of position, leading to an accident.

### NOTE

- The chocks shown in the illustration do not come with your vehicle. It is recommended that you purchase chocks or blocks and keep them in the vehicle for use if needed.
- If chocks or blocks are not available, use stones or any other objects that are large enough to hold the wheel in position.

6. Get the jack, bar and wheel nut wrench ready. (Refer to "Jack and tools" on page 8-6.)

### To change a tire

N00849801574

1. Loosen the wheel nuts with the wheel nut wrench. Do not remove the wheel nuts yet.

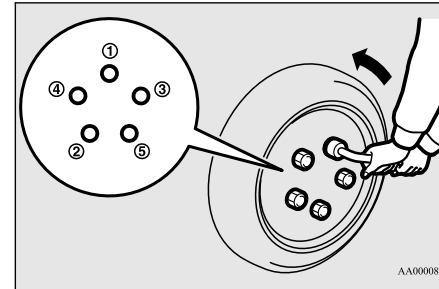

2. Place the jack under one of the jacking points (A) shown in the illustration. Use the jacking point closest to the tire you wish to change.

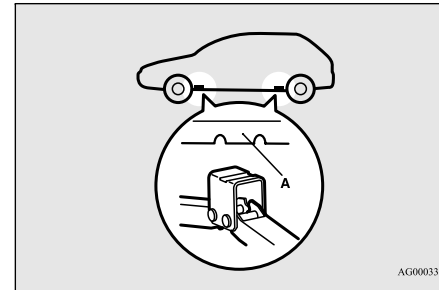



## How to change a tire

### **⚠ WARNING**

- Set the jack only at the positions shown here. If the jack is set at a wrong position, it could dent your vehicle or the jack might fall over and cause personal injury.
- Do not use the jack on a tilted or soft surface. Otherwise, the jack might slip and cause personal injury. Always use the jack on a flat, hard surface. Before setting the jack, make sure there are no sand or pebbles under the jack base.

3. Rotate the jack by hand until the flange portion (B) fits in the groove (C) at the top of the jack.

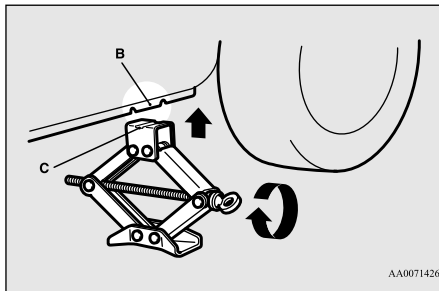

4. Insert the bar (D) into the wheel nut wrench (E). Then put the end of the bar into the shaft's jack end, as shown in the illustration.

Slowly rotate the wheel nut wrench until the tire is raised slightly off the ground surface.

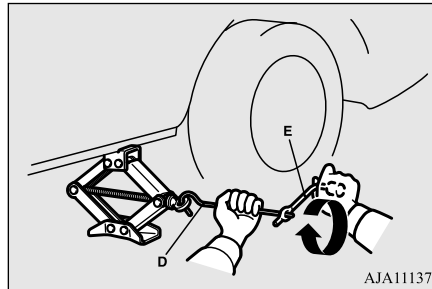

### **⚠ WARNING**

- Stop jacking up the vehicle as soon as the tire is raised off the ground. It is dangerous to raise the vehicle any higher.
- Do not get under your vehicle while using the jack.
- Do not bump the raised vehicle or leave it sitting on the jack for a long time. Both are very dangerous.
- Do not use a jack except the one that came with your vehicle.
- The jack should not be used for any purpose other than to change a tire.

### **⚠ WARNING**

- No one should be in your vehicle when using the jack.
- Do not start the Plug-in Hybrid EV system while your vehicle is on the jack.
- Do not turn the raised wheel. The tires that are still on the ground could turn and make your vehicle fall off the jack.

5. Remove the wheel nuts with the wheel nut wrench, then take the wheel off.

### **⚠ CAUTION**

- Handle the wheel carefully when changing the tire, to avoid scratching the wheel surface.

6. Clean out any mud, etc. on the hub surface (F), hub bolts (G) or in the installation holes (H) in the wheel, and then mount the spare tire.

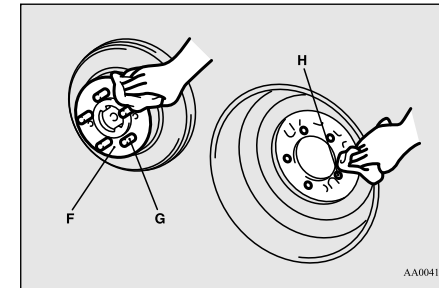

## How to change a tire

### **⚠ WARNING**

- Mount the spare wheel with the valve stem (I) facing outward. If you cannot see the valve stem (I), you have installed the wheel backwards. Operating the vehicle with the spare wheel installed backwards can cause vehicle damage and result in an accident.

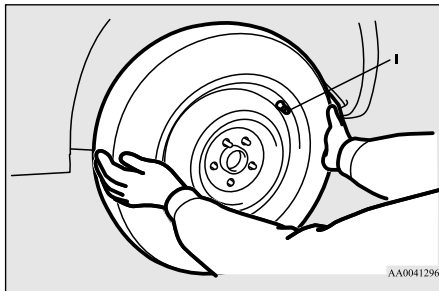

7. Turn the wheel nut clockwise by hand to initially tighten them.
- Temporarily tighten the wheel nuts by hand until the flange parts of the wheel nuts make light contact with the wheel and the wheel is not loose.

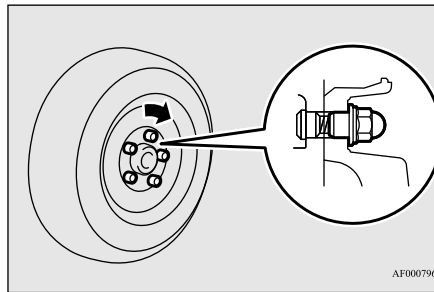

### **⚠ CAUTION**

- Never apply oil to either the wheel bolts or the nuts or they will tighten too much.

8. Lower the vehicle slowly until the tire touches the ground, by rotating the wheel nut wrench counterclockwise.

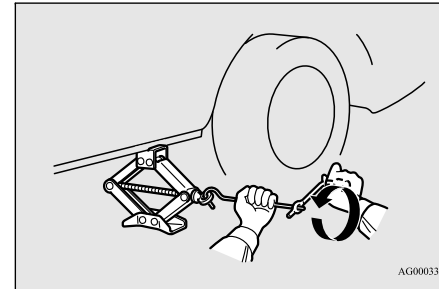

9. Tighten the nuts in the order shown in the illustration until each nut has been tightened to the torque listed here.
- 65 to 80 ft-lb (88 to 108 N•m)**

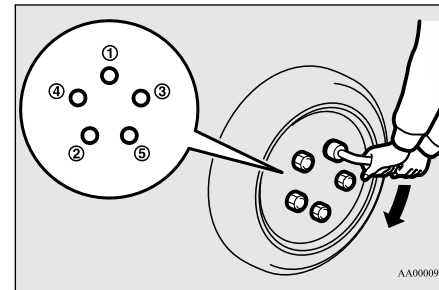

## Towing

### CAUTION

- Never use your foot or a pipe extension to apply added force to the wheel nut wrench when tightening the wheel nuts. If you do so, you can over-tighten the wheel nuts and damage the wheel, wheel nuts and hub bolts.

10. Lower the jack all the way and remove it.
11. Check the tire inflation pressure. The recommended tire pressure for your vehicle is listed on the tire and loading information placard attached to the driver's door sill as shown in the illustration. Refer to "Tire inflation pressures" on page 9-17.

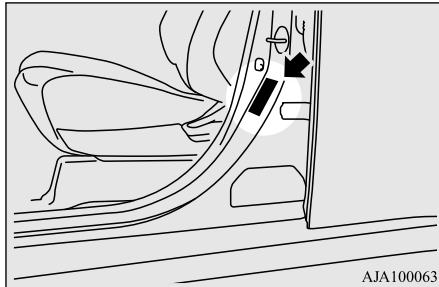

### CAUTION

- Driving with an improperly inflated tire can cause an accident. If you have no choice but to drive with an under-inflated tire, keep your speed down and avoid sudden steering or braking, if possible. Inflate the tire to the correct pressure as soon as possible. Refer to "Tire inflation pressures" on page 9-17.
- After changing the tire and driving the vehicle approximately 620 miles (1,000 km), retighten the wheel nuts to make sure that they have not come loose.
- If the steering wheel vibrates when driving after changing the tire, have the tire checked for balance at a certified Mitsubishi EV dealer.
- Do not mix one type of tire with another or use a different size from the one listed. This would cause early wear and poor handling.

### To store the jack, bar and wheel nut wrench

N00850001185

Reverse the removing procedure when storing the jack, bar and wheel nut wrench. Refer to "Jack and tools" on page 8-6.

## Towing

N00837002013

### If your vehicle needs to be towed

If you need to tow your vehicle, contact a certified Mitsubishi EV dealer or a commercial tow truck service.

Transport the vehicle on a flatbed truck or tow the vehicle with all wheels off the ground.

8

Flat bed type

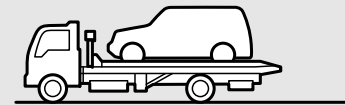

Dolly type



In the following cases, contact a certified Mitsubishi EV dealer and transport the vehicle with the all wheels on a carriage.

For emergencies 8-17

## Towing

- The ready indicator illuminates but the vehicle does not move, or an abnormal noise is produced.
- Some warning light in the meter illuminates.
- Inspection of the vehicle's underside reveals that oil or some other fluid is leaking.
- Your vehicle body is severely damaged or deformed in the event of an accident.

If a wheel gets stuck in a ditch, do not try to tow the vehicle.

8

Please contact a certified Mitsubishi EV dealer or a commercial tow truck service for assistance.

There may be local regulations concerning towing in your area. Obey the regulations in the area where you are driving your vehicle.

### CAUTION

- Never attempt to tow the vehicle using another vehicle with a rope.
- If the drive-train or suspension has a problem, do not tow the vehicle with only the rear wheels or front wheels placed on a dolly.

## Towing the vehicle by a tow truck

### WARNING

- Never get under your vehicle after it has been lifted by a tow truck.
- Never ride in a vehicle that is being towed.

### WARNING

- Never tow the vehicle with front wheels and/or rear wheels on the ground. This may cause damage to the electric motors and transaxle.

Towing with all wheels on the ground

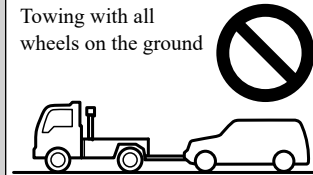

Towing with front wheels on the ground

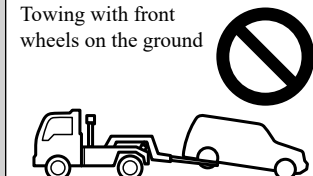

Towing with rear wheels on the ground

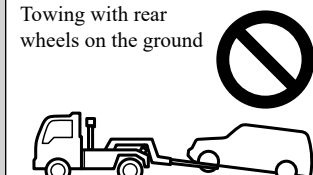

AJM100911

## Operation under adverse driving conditions

### ⚠ CAUTION

- Never tow the vehicle using a sling type truck. Doing so will damage the bumper and/or body.

Towing with a sling-type truck

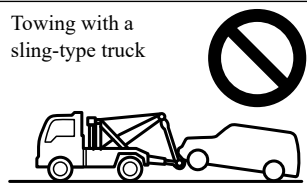

AJZ100332

## Operation under adverse driving conditions

N00837201803

### If your vehicle becomes stuck in sand, mud or snow

If your vehicle becomes stuck in snow, sand, or mud, it can often be moved by a rocking motion. Rock your vehicle back and forth to free it.

Do not spin the wheels. Constant efforts to free a stuck vehicle can cause transaxle failure.

If your vehicle is still stuck after several rocking attempts, call for a commercial tow truck service.

### ⚠ WARNING

- When trying to rock your vehicle out of a stuck position, make sure that there are no people nearby. The rocking motion can make your vehicle suddenly lurch forward or backward, and injure any bystanders.

### On wet roads

### ⚠ CAUTION

- Do not drive on a flooded road. If you drive on a flooded road, not only the Plug-in Hybrid EV System stops but also a failure like electric leakage or short circuit may occur.  
If you inevitably had to run on a flooded road and the vehicle was exposed to water, be sure to have your vehicle inspected by a certified Mitsubishi EV dealer.
- When driving in rain, on water-covered roads, or through a car wash, water could get into the brake discs and make them fail temporarily. In such cases, lightly press the brake pedal to see if they are working properly. If they are not, press the pedal lightly several times while driving to dry the brake pads or linings, then check them again.

### ⚠ CAUTION

- When driving in rain, a layer of water may form between the tires and the road surface (hydroplaning). This loosens your tires' grip on the road, making it difficult to steer or brake properly. When driving on a wet road:
  - Drive your vehicle at a safe speed.
  - Do not drive on worn tires.
  - Always keep the tires at the correct inflation pressures.

### On snowy or icy roads

8

- When driving on a road covered with snow or ice, use snow tires. Tire chains cannot be used on your vehicle. There may be state or local regulations about using snow tires. Always check the regulations in your local area before using them. Refer to "Snow tires" on page 9-20 and "Tire chains" on page 9-20.
- Drive slowly. Do not make sudden starts or stops, sharp turns, or slam on the brakes.
- Allow extra distance between your vehicle and the vehicle in front of you, and avoid sudden braking.
- If a skid occurs when the accelerator pedal is depressed, take your foot off the pedal. Steer gently in the direction of the skid.

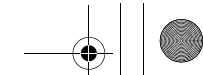

## Fuel Pump Shut-off System

- Your vehicle is equipped with an anti-lock braking system (ABS). Hold the brake pedal down firmly and keep it depressed. Do not pump the brake pedal which will result in reduced braking performance.
- After parking on snowy or icy roads, it may be difficult to move your vehicle due to the brake being frozen. Depress the accelerator pedal little by little to move the vehicle when safe to do so.

### CAUTION

- Do not depress the accelerator pedal rapidly. The vehicle could start moving when it breaks free from the ice, possibly resulting in an accident.

8

## On a bumpy or rutted road

- Drive as slow as possible when driving on bumpy, rutted roads or over potholes.

### CAUTION

- Driving on bumpy, rutted roads or over potholes can damage the tires and wheels. Wheels with low-profile tires or under-inflated tires are especially at risk for damage.

## Fuel Pump Shut-off System

N00860600057

### WARNING

- Before attempting to restart the Plug-in Hybrid EV system after a collision, always inspect the ground under the vehicle for leaking fuel. If a fuel leak is found or a fuel odor is detected, do not restart the Plug-in Hybrid EV system.
- Mitsubishi Motors recommends that your vehicle be inspected by a certified Mitsubishi EV dealer after any collision.

In the event of a collision causing frontal air-bag deployment, the fuel pump shut-off system will activate to stop fuel supply to the engine.

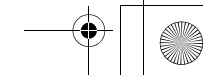
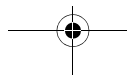







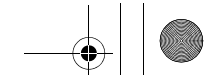

## Vehicle care and maintenance

Service precautions .....	9-2
Catalytic converter .....	9-3
Engine hood .....	9-4
View of the engine compartment .....	9-6
Engine oil and oil filter .....	9-6
Engine coolant/Plug-in Hybrid EV System coolant .....	9-8
Air cleaner filter .....	9-10
Front motor fluid .....	9-10
Transaxle fluid .....	9-10
Washer fluid .....	9-10
Brake fluid .....	9-11
12 V starter battery .....	9-12
Tires .....	9-12
Brake pedal free play .....	9-21
Wiper blades .....	9-21
Emission-control system maintenance .....	9-21
General maintenance .....	9-22
For cold and snowy weather .....	9-24
Fusible links .....	9-24
Fuses .....	9-24
Replacement of light bulbs .....	9-30
Vehicle care precautions .....	9-39
Cleaning the inside of your vehicle .....	9-40
Cleaning the outside of your vehicle .....	9-41

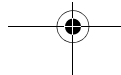

## Service precautions

### Service precautions

N00937301629

Taking regular care of your vehicle will preserve its value and appearance as long as possible.

This vehicle is a Plug-in Hybrid Electric Vehicle and is equipped with many high-voltage components.

Refer to “High-voltage components” on page 3-36.

You can do some of the maintenance work yourself, and the rest should only be performed by a certified Mitsubishi EV dealer.

**9**

If you discover a malfunction or other problem, have it corrected by a certified Mitsubishi EV dealer.

This section describes the maintenance inspections that you can do yourself, if you so desire. Follow the instructions and precautions for each procedure.

### ⚠ WARNING

- Never touch, remove or disassemble the high-voltage components including high-voltage wires colored orange and their connectors. Doing so can result in a fire, property damage, electrocution and serious injury or death.

These components are affixed with a label indicating precautions for handling. Follow the instructions on the label. Take your vehicle to a certified Mitsubishi EV dealer for any necessary maintenance.

High voltage components and wiring cables are located as shown in the figure below.

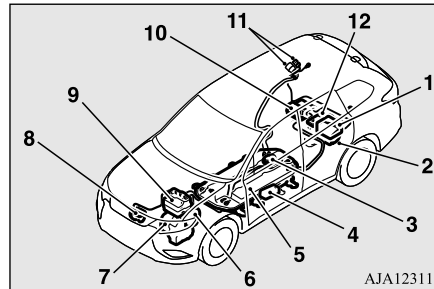

- 1- On board charger/DC-DC converter
- 2- Rear motor
- 3- Service plug
- 4- Electric heater
- 5- Main drive lithium-ion battery
- 6- Front motor
- 7- Generator

- 8- Air conditioner compressor
- 9- Power drive unit (PDU)
- 10- Rear electric motor control unit (MCU)
- 11- Normal charge port/Quick charge port (if so equipped)
- 12- 120 V AC power supply (if so equipped)

### ⚠ WARNING

- When servicing the vehicle, make sure that the operation mode of the power switch is put in OFF and the charging cable is disconnected. Failure to do so could result in an electric shock.
- When checking or servicing the inside of the engine compartment, be sure the Plug-in Hybrid EV system is stopped and has had a chance to cool down.
- If you need to work in the engine compartment with the Plug-in Hybrid EV system running, be especially careful that your clothing, hair, etc. does not get caught in the cooling fans, drive belts, or other moving parts.

## Catalytic converter

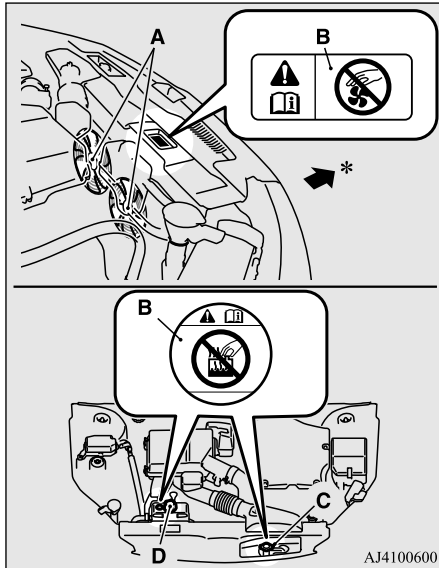

- A- Cooling fans
  - B- Caution label
  - C- Radiator cap
  - D- Reserve tank cap for the Plug-in Hybrid EV system cooling
- \*: Front of the vehicle

### ⚠ WARNING

- After performing the maintenance work, make sure that no tools or cloths are left behind in the engine compartment. If they are left behind, a fire or damage to the vehicle may occur.
- The cooling fans can turn on automatically even if the Plug-in Hybrid EV system is not running. Put the operation mode of the power switch in OFF to be safe while you work in the engine compartment.
- Do not smoke or allow open flames around fuel or the 12 V starter battery. The fumes are flammable.
- Be extremely careful when working around the 12 V starter battery. It contains poisonous and corrosive sulfuric acid.
- Do not get under your vehicle while it is on a jack. Always use properly rated automotive jack stands.
- Handling your vehicle's parts and materials in the wrong way can injure you. Ask a certified Mitsubishi EV dealer if you have questions.



### DIAMOND CARE PROTECTION PLAN

Have you purchased the Mitsubishi Motors Diamond Care Protection Plan? The Plan supplements your new vehicle warranties. See a certified Mitsubishi EV dealer for details.

9

### Catalytic converter

N00937401460

The catalytic converter requires you to use unleaded fuel only. Leaded gasoline will destroy the emission-control effectiveness of the converter.

Normally, the catalytic converter does not require maintenance. However, it is important to keep the engine properly tuned for the converter to continue to work properly.

## Engine hood

### ⚠ CAUTION

● Damage to the catalytic converter can result if your vehicle is not kept in proper operating condition. If the engine malfunctions or misfires, or if your vehicle performance suffers, have it serviced promptly. Running your vehicle when it is overheated may result in damage to the converter and vehicle.

### ⚠ WARNING

● **Do not park or run your vehicle in areas where combustible materials such as dry grass or leaves can come in contact with a hot exhaust, since a fire could occur.**

● **Do not put undercoat paint on the catalytic converter.**

9

To reduce the possibility of catalytic converter damage:

- Use UNLEADED GASOLINE ONLY of the type of recommended in the “Fuel selection”.
- Do not drive with an extremely low fuel level. Running out of gas could damage the catalytic converter.
- Do not try to start the Plug-in Hybrid EV system by pushing or towing the vehicle. If the 12 V starter battery is weak or run down, use jumper cables to properly start the Plug-in Hybrid EV system.

- Do not idle the engine with any spark plug wires disconnected or removed, such as when performing diagnostic tests.
- Do not idle the engine for a long time by using the battery charge mode switch if it is idling roughly or otherwise obviously malfunctioning.
- To prevent the catalytic converter from being damaged from unburned gas, do not race the engine when turning off the Plug-in Hybrid EV system.
- Stop driving the vehicle if you think the performance is noticeably low, or the engine has a malfunction such as with the ignition, etc. If you are not able to stop driving immediately, slow down and drive for only a short time. Have your vehicle checked at a certified Mitsubishi EV dealer as soon as possible.
- In unusual situations involving major engine problems, a burning odor may indicate severe and abnormal catalytic converter overheating. If this occurs, stop in a safe place, shut the Plug-in Hybrid EV system off and let the vehicle cool. Once the engine is cool, immediately take your vehicle to a certified Mitsubishi EV dealer for service.

## Engine hood

N00937501621

### To open

Use the engine hood release lever (located under the instrument panel near the driver’s door) to unlock the engine hood.

Pull the lever toward you to release the engine hood latch.

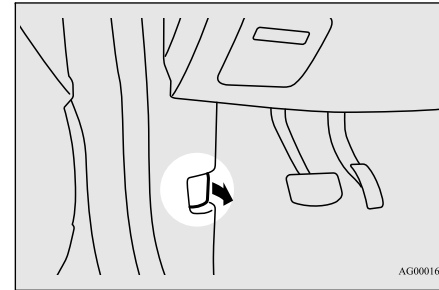

### ⚠ WARNING

- **Never use the release lever to unlatch the engine hood while the vehicle is in motion.**
- **Do not drive your vehicle unless the engine hood is locked.**

## Engine hood

Release the lever and lift the engine hood.

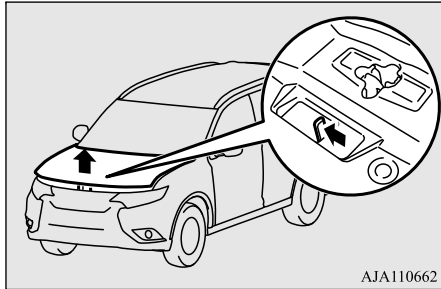

### NOTE

- To prevent damage to the engine hood and wipers, make sure the wipers are at resting position when you open the engine hood.

Support the engine hood with the hood prop. Insert the hood prop securely in the opening under the hood marked with an arrow.

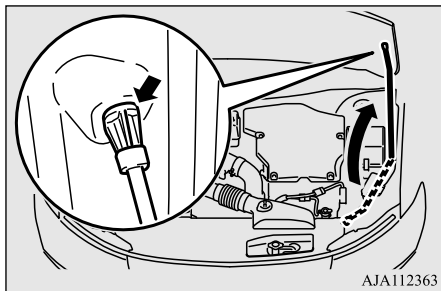

### CAUTION

- Always insert the support prop into the hole specially made for it. Propping the engine hood at any other place could cause the prop to slip out and lead to an accident.
- The hood prop can fall out if the hood is lifted by a strong wind.

### To close

Unlatch the prop from the engine hood and put it back in its retainer.

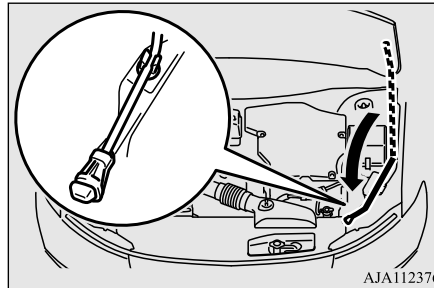

Slowly lower the engine hood approximately 8 inches (20 cm), then let it drop from its own weight.

### CAUTION

- Be careful not to trap your hands or fingers when closing the engine hood.

### CAUTION

- Make sure the engine hood is firmly closed before driving.  
If you drive without the engine hood completely closed, it could open up while driving.

### NOTE

- If this does not close the engine hood properly, drop it again from a slightly higher position.
- Do not push down strongly on the engine hood. Depending on how strongly or where you push down, you could create a dent in the vehicle body.
- If you drive with the engine hood left open, a warning display is displayed on the information screen in the multi-information display.

  
CLOSE HOOD

## View of the engine compartment

### View of the engine compartment

N00937601778

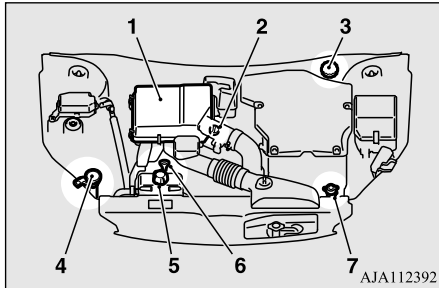

9

- 1- Air cleaner filter
- 2- Engine oil cap
- 3- Brake fluid reservoir
- 4- Washer fluid reservoir
- 5- Plug-in EV system coolant reservoir
- 6- Engine oil level dipstick
- 7- Engine coolant reservoir

### Engine oil and oil filter

N00937702167

#### To check and refill engine oil

It is normal for an engine to use oil. You may need to add oil between the recommended oil change intervals. Before starting the Plug-in

9-6 Vehicle care and maintenance

Hybrid EV system, check the engine oil level. Refill if necessary.

To check the oil level, remove the dipstick, wipe it off, and gently reinsert it all the way. Slowly pull the dipstick straight out and check the oil level by checking the upper surface of the dipstick. The oil level must not go above the line on the dipstick.

#### NOTE

- If it is difficult to verify the oil level, wipe off the dipstick and reinsert it. Wait a moment and then recheck the oil level by checking the upper surface of the dipstick.

If the level does not reach the line which shows the minimum amount of oil required, remove the oil filler cap on the engine valve cover, and fill to within the “Good” range.

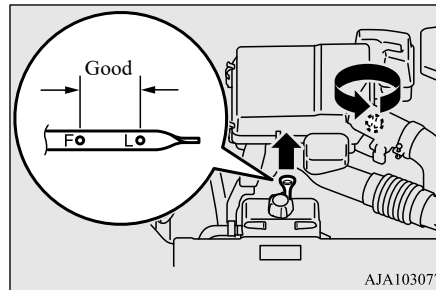

#### CAUTION

- Overfilling will cause oil aeration and loss of oil pressure, which could damage the engine.

#### WARNING

- Used engine oil is poisonous, and can damage your skin. Prolonged and repeated contact may cause serious skin disorders, including dermatitis and cancer. Do not let used oil touch your skin and wash thoroughly after working with it.
- Keep used oil out of the reach of children.

#### NOTE

- Engine oil consumption is greatly influenced by payload, engine speed, etc.
- The engine oil will deteriorate rapidly if the vehicle is subjected to severe conditions (for example, repeated operation on rough roads, in mountainous regions, on roads with many uphill and downhill gradients). Consequently, the oil will require earlier replacement in accordance with the schedule in the “WARRANTY AND MAINTENANCE MANUAL”.

### Engine oil identification mark

Mitsubishi Motors recommends using only engine oils with the ILSAC certification symbol on the front of the container.

ILSAC certification symbol



TA0000313

If you cannot find oils with the ILSAC certification symbol, use an API classification SP oil with the following label.

This mark appears on the top of the oil container and tells you two important things about the oil.

API service symbol

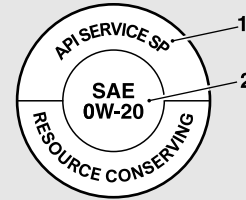

AJA123291

- 1- The upper part indicates the quality of the oil.
- 2- The center part indicates the SAE grade of the oil viscosity.

### Recommended engine oil viscosity

Use engine oil with the proper thickness for the outdoor temperatures where you will be driving.

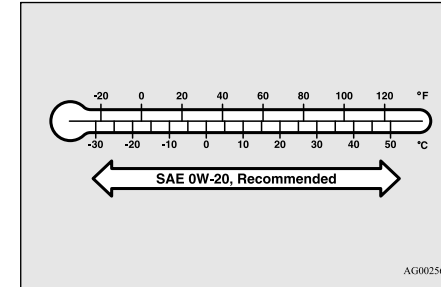

Mitsubishi Motors Genuine 0W-20 Synthetic Engine Oil is recommended for optimum fuel economy and cold weather starting.

If Mitsubishi Motors Genuine 0W-20 Synthetic Engine Oil is not available, 5W-20 grade oils displaying the ILSAC certification can be used.

However, Mitsubishi Motors Genuine 0W-20 Synthetic Engine Oil should be used at the next oil change to maintain optimum fuel economy and cold weather starting.

## Engine coolant/Plug-in Hybrid EV System coolant

### To replace the oil filter

The oil filter should be replaced at the time or mileage specified in the “WARRANTY AND MAINTENANCE MANUAL”.

Only use high quality replacement filters on this vehicle. The manufacturer’s specifications for Mitsubishi Motors Genuine oil filters require that the filter can withstand a pressure of 256 psi (1.8 MPa). A Mitsubishi Motors Genuine oil filter is the best replacement filter.

Follow the installation instructions printed on the filter.

9

### Engine coolant/Plug-in Hybrid EV System coolant

N00937801666

### To check the coolant level

The engine coolant reservoir (A) and the Plug-in Hybrid EV system coolant reservoir (B) lets you quickly see when you need to add coolant. When the engine and the Plug-in Hybrid EV system are cold, the level of the coolant in the reservoir should be between the FULL and LOW marks. The radiator usually stays full so there is no reason to remove the radiator cap (C) except when you check the coolant freeze point or replace the antifreeze coolant.

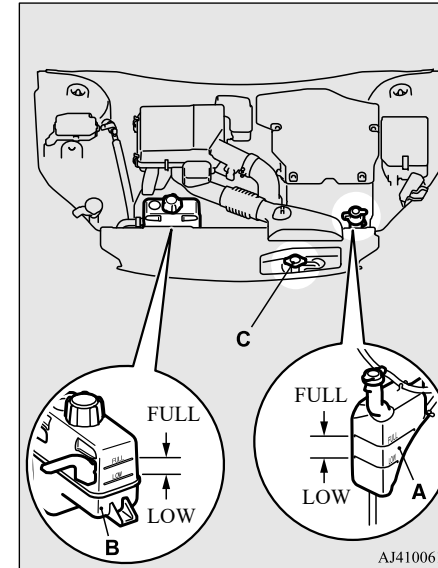

### To add coolant

Use “Mitsubishi Motors Genuine Super Long Life Coolant Premium” or equivalent\*.

\*: similar high quality ethylene glycol based non-silicate, non-amine, non-nitrate and non-borate coolant with long life hybrid organic acid technology



## Engine coolant/Plug-in Hybrid EV System coolant

Mitsubishi Motors Genuine Coolant provides excellent protection against corrosion and rust formation on all metals, including aluminum, and prevents clogs in some parts of engine.

If you need to add coolant often, or if the level in the reservoir does not drop when the engine and the Plug-in Hybrid EV system cool, the cooling system should be pressure-tested for leaks. Take your vehicle to a certified Mitsubishi EV dealer for testing.

**CAUTION**

- Do not use alcohol or methanol antifreeze or any engine coolants that contain them. Using the wrong antifreeze can corrode aluminum parts.
- The required concentration of anti-freeze differs depending on the expected ambient temperature.  
Above -31 °F (-35 °C): 50 % concentration of anti-freeze  
Below -31 °F (-35 °C): 60 % concentration of anti-freeze  
You can check the concentration level with a gauge from an automotive supply store, or a certified Mitsubishi EV dealer or service station can check it for you.
- Do not use water to adjust the concentration of coolant.

**CAUTION**

- Do not top off the reservoir with plain water only. Water by itself boils at a lower temperature and does not stop rust or freezing. If the water freezes, it will damage your cooling system. Do not use tapwater. It can cause corrosion and rust.

**Radiator cap**

The radiator cap must be sealed tight to prevent losing coolant, which may result in engine damage. Only use a Mitsubishi Motors Genuine Parts radiator cap, or an approved equivalent.

**WARNING**

- Wait for the engine and the Plug-in Hybrid EV system to cool down before opening the radiator cap (C) and the reservoir cap (D). Otherwise hot steam or boiling coolant could spray up from the filler port and scald you.



9

**Points to remember**

- Do not overfill the reservoir.
- Your vehicle uses a special radiator cap and reservoir cap that stays sealed and lets the coolant flow from the reservoir back to the radiator when the engine and the Plug-in Hybrid EV system cool down. If you need to change the cap, use the exact same kind.

Vehicle care and maintenance 9-9

## Air cleaner filter

- Check the coolant freeze point in the radiator with the proper gauge, and only when it is safe. If you add antifreeze, the contents of the reservoir must be protected against freezing.
- Keep the front of the radiator and condenser clean.

### Air cleaner filter

N00937901524

The air cleaner filter will get dirty and dusty from use and not filter properly. Replace it with a new filter using the schedule in the “WARRANTY AND MAINTENANCE MANUAL”.

9

1. Unclamp the cover. Open up the cover and take out the air cleaner filter.

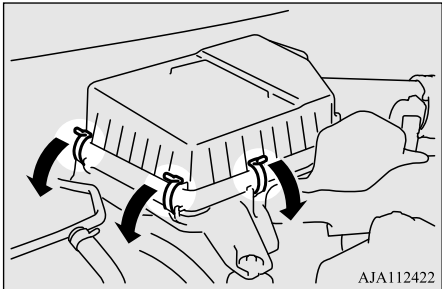

2. Replace the air cleaner filter and put the cover back on in its original position.

### NOTE

- Mitsubishi Motors Genuine Parts are recommended when replacing the air cleaner filter.
- After replacing the air cleaner filter, make sure that the hinges (A) of cover are firmly set.

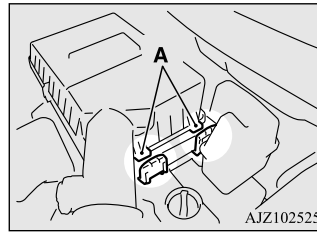

### Front motor fluid

N00947500034

Whenever the fluid level is checked, add fluid as necessary to maintain the proper level. Fill with the fluid according to the table below.

### Fluid type

Lubricant	Mitsubishi Motors Genuine CVTF-J4 or CVTF-J4+
-----------	---

### CAUTION

- Using the improper fluid may damage the front motor.

### Transaxle fluid

N00947600022

Whenever the fluid level is checked, add fluid as necessary to maintain the proper level. Fill with the fluid according to the table below.

### Fluid type

Lubricant	Mitsubishi Motors Genuine ATF SPIII
-----------	-------------------------------------

### CAUTION

- Using the improper fluid may damage the transaxle.

### Washer fluid

N00938601443

The windshield and rear window washer fluid reservoir is in the engine compartment.

Check the washer fluid level at regular intervals and add washer fluid to reservoir if necessary.

Open the reservoir cap and check the fluid level with the dipstick.

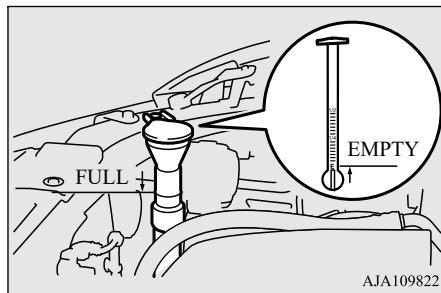

When freezing weather is anticipated, flush out the water in the reservoir by operating the pump. Fill the reservoir with windshield anti-freeze (not radiator antifreeze), and operate the system for a few seconds to flush out the residual water.

### CAUTION

- Do not use any fluid other than washer fluid. Also, do not use such as soapy water, glass cleaner, and engine coolant. Using other liquids can cause damage to the vehicle, such as could cause streaking on the vehicle's painted surfaces, damage to the washer pump, or clogging the nozzle, leading to the washer fluid not spraying.

### CAUTION

- Over-diluting the washer fluid in winter may cause it to freeze onto the windshield.

### Brake fluid

N00938701385

### To check the fluid level

Check the fluid level in the reservoir. The fluid level must be between the "MAX" and "MIN" marks on the reservoir.

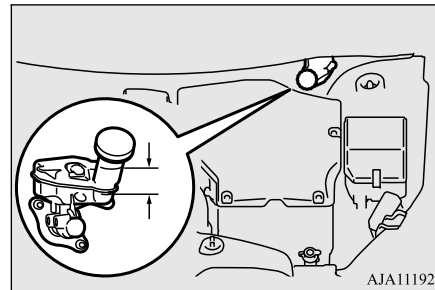

The fluid level falls slightly with wear of the brake pads, but this does not indicate any abnormality.

If the fluid level falls markedly in a short length of time, it indicates leaks from the brake system.

If this occurs, have the vehicle checked by a certified Mitsubishi EV dealer.

### Fluid type

Use the recommended brake fluid conforming to DOT 3 or DOT 4. The reservoir cap must be tightly sealed to keep dirt and water out.

### WARNING

- Take care in handling brake fluid as it is harmful to the eyes, may irritate your skin and will damage painted surfaces. Wipe up spills immediately. If brake fluid gets on your hands or in your eyes, flush immediately with clean water. Follow up with a doctor as necessary.

### CAUTION

- Do not let any petroleum-based fluid touch, mix with, or get into the brake fluid. This will damage the seals.
- Use only the listed brake fluid. Different brands of brake fluid have different additives, and these can cause a chemical reaction. Do not mix brands of brake fluid.
- Keep the reservoir cap closed to keep the brake fluid from evaporating.

## 12 V starter battery

### 12 V starter battery

N00939101982

The condition of the 12 V starter battery is very important for quick starting of the Plug-in Hybrid EV system and to keep the vehicle's electrical system working properly. Be sure to have a certified Mitsubishi EV dealer check the 12 V starter battery regularly.

If the 12 V starter battery performance is suspect, have the 12 V starter battery and charging system tested by a certified Mitsubishi EV dealer.

9

#### ⚠ WARNING

- Be sure to have a certified Mitsubishi EV dealer charge the 12 V starter battery. Do not charge the 12 V starter battery yourself. Flammable gases may leak and explode.

#### ⚠ CAUTION

- The 12 V starter battery may not be properly installed in the vehicle, even if the same type or specification. When replacing the 12 V starter battery, please contact a certified Mitsubishi EV dealer.

9-12 Vehicle care and maintenance

#### 📖 NOTE

- When the 12 V starter battery is removed, the controlling timer for forcibly starting the engine may be reset. Since a fuel injection device may cause a clogging if the state where the engine does not operate continues after reset of the timer, select the battery charge mode in order to start the engine. However, when the main drive lithium-ion battery is near full charge, even if the battery charge mode is selected, the engine may not start. In that case, select the battery charge mode again after the main drive lithium-ion battery quantity decreases. Refer to "Battery charge mode" on page 5-69.

#### During cold weather

The battery is weaker in cold temperatures. This has to do with its chemical and physical properties and is why a very cold battery, especially one with a low charge, will have a hard time starting your vehicle.

It is recommended that you have your 12 V starter battery and charging system checked by a certified Mitsubishi EV dealer before the start of cold weather. If necessary, have it charged. This will provide more reliable starting, and longer 12 V starter battery life.

## Tires

N00939201707

#### ⚠ WARNING

- **Driving with tires that are worn, damaged or improperly inflated is dangerous. These type tire conditions will adversely affect vehicle performance. These type tire conditions can also cause a tread separation or blowout which may result in an accident causing serious injury or death.**
- **Tires degrade over time with age even when they are not being used. It is recommended that tires over 6 years generally be replaced even if damage is not obvious.**

It is important to familiarize yourself with the following terms:

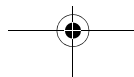
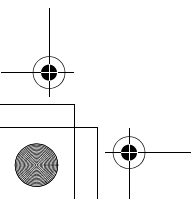
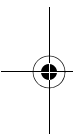
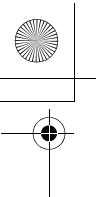

## Tires

- Cold tire pressure:
  - The measured pressure after the vehicle has been parked for at least three hours,
  - or
  - The measured pressure when the vehicle is driven less than 1 mile (1.6 km) after having been parked for three hours.
- Maximum pressure: the maximum permissible cold tire inflation pressure for this tire.
- Recommended inflation pressure: the inflation pressure for optimum tire performance.
- Intended outboard sidewall:
  - The sidewall that contains a whitewall, bears white lettering or bears manufacturer, brand, and/or model name molding that is higher or deeper than the same molding on the other sidewall of the tire,
  - or
- The outward facing sidewall of an asymmetrical tire that has a particular side that must always face outward when mounted on a vehicle.
- Passenger car tire: a tire intended for use on passenger cars, multi-purpose passenger vehicles, and trucks that have a gross vehicle weight rating (GVWR) of 10,000 pounds or less.
- Light truck (LT) tire: a tire designated by its manufacturer as primarily intended for use on lightweight trucks or multipurpose passenger vehicles.
- Tread: portion of a tire that comes into contact with the road.
- Tread rib: a tread section running circumferentially around a tire.
- Tread separation: pulling away of the tread from the tire carcass.
- Carcass: the tire structure, except tread and sidewall rubber which, when inflated, bears the load.
- Sidewall: portion of a tire between the tread and bead.
- Section width: the linear distance between the exteriors of the sidewalls of an inflated tire, excluding elevations due to labeling, decoration, or protective bands.
- Bead: the part of the tire that is made of steel wires, wrapped or reinforced by ply cords and that is shaped to fit the rim.
- Ply: a layer of rubber-coated parallel cords.
- Cord: the strands forming the plies in the tire.
- Rim: a metal support for a tire or a tire and tube assembly upon which the tire beads are seated.
- Rim diameter: nominal diameter of the bead seat.
- Groove: the space between two adjacent tread ribs.

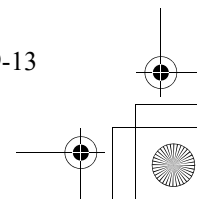
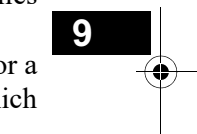
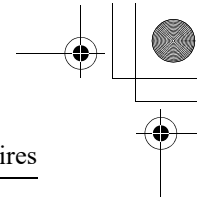

Tires

**Tire Markings**

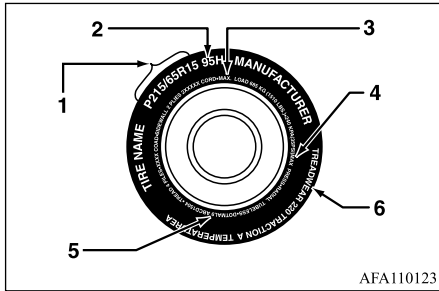

AFA110123

**9**

- 1- Size Designation
- 2- Service Description
- 3- Maximum Load
- 4- Maximum Pressure
- 5- U.S. DOT Safety Standards Code (TIN)
- 6- Treadwear, Traction and Temperature Grades

**Size Designation**

**EXAMPLE: P215/65R15**

P	Passenger car tire size based on U.S.A. design standards
215	Section width in millimeters (mm)
65	Aspect ratio in percent (%) Ratio of section height to section width of tire.
R	Construction code •“R” means radial construction. •“D” means diagonal or bias construction.
15	Rim diameter in inches (in)

**NOTE**

- European/Japanese metric tire sizing is based on European/Japanese design standards. Tires designed to these standards have the tire size molded into the sidewall beginning with the section width. The letter “P” is absent from this tire size designation.  
Example: 215/65R15 96H.
- LT (Light Truck) -metric tire sizing is based on U.S.A. design standards. The size designation for LT-metric tires is the same as for P-metric tires except for the letters “LT” that are molded into the sidewall preceding the size designation.  
Example: LT235/85R16.

**Service Description**

**EXAMPLE: 95H**

95	<p>Load index A numerical code associated with the maximum load a tire can carry.</p>
H	<p>Speed symbol A symbol indicating the range of speeds at which a tire can carry a load corresponding to its load index under certain operating conditions. The maximum speed corresponding to the speed symbol should only be achieved under specified operating conditions. (i.e. tire pressure, vehicle loading, road conditions and posted speed limits)</p>

**Maximum Load**

Maximum load indicates the maximum load this tire is designed to carry.

**WARNING**

● **Overloading of your tire is dangerous. Overloading can cause tire failure, affect vehicle handling, and increase your stopping distance. Use tires of the recommended load capacity for your vehicle. Never overload them.**

**Maximum Pressure**

Maximum Pressure indicates the maximum permissible cold tire inflation pressure for this tire.

**Tire Identification Number (TIN)**

The TIN may be found on one or both sides of the tire but the date code may only be on one side. Look for the TIN on the outboard side of tires as mounted on the vehicle. If the TIN is not found on the outboard side then you will find it on the inboard side of the tire.

Tires

**EXAMPLE: DOT MA L9 ABCD 1504**

DOT	Department of Transportation This symbol certifies that the tire is in compliance with the U.S. Department of Transportation tire safety standards, and is approved for highway use.
MA	Code representing the tire manufacturing location. (2 digits)
L9 ABCD	Code representing the tire size. (2 digits) Code used by tire manufacturer. (1 to 4 digits)
15	Number representing the week in which the tire was manufactured. (2 digits)
04	Number representing the year in which the tire was manufactured. (2 digits)

9

**Treadwear, Traction and Temperature Grades**

**Treadwear**

The treadwear grade is a comparative rating based on the wear rate of the tire when tested under controlled conditions on a specified government test course. For example, a tire graded 150 would wear one and one-half (1<sup>1</sup>/<sub>2</sub>) times as well on the government course as a tire graded 100. The relative performance of tires depends upon the actual conditions of their use, however, and may depart significantly from the norm due to variations in driving habits, service practices and differences in road characteristics and climate.

**Traction**

The traction grades, from highest to lowest, are AA, A, B and C. Those grades represent the tire's ability to stop on wet pavement as measured under controlled conditions on specified government test surfaces of asphalt and concrete. A tire marked C may have poor traction performance.

**Temperature**

The temperature grades are A (the highest), B and C, representing the tire's resistance to the generation of heat and its ability to dissipate heat when tested under controlled conditions on a specified indoor laboratory test wheel. Sustained high temperature can cause the material of the tire to degenerate and reduce tire life, and excessive temperature can lead to sudden tire failure. The grade C corresponds to a level of performance which all passenger car tires must meet under the Federal Motor Vehi-



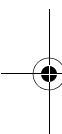

cle Safety Standard No. 109. Grades B and A represent higher levels of performance on the laboratory test wheel than the minimum required by law.

### Tire inflation pressures

N00939302040

Proper tire inflation pressure is essential for the safe and satisfactory operation of your vehicle. The wrong tire pressure will cause problems in three major areas:

- Safety  
Too little pressure increases flexing in the tire and can cause tire failure. Too much pressure can cause a tire to lose its ability to cushion shock. Objects on the road and potholes could then cause tire damage that may result in tire failure.
- Economy

The wrong tire pressure can cause uneven wear patterns in the tire tread. These abnormal wear patterns will reduce the tread life, and the tire will have to be replaced sooner.

Too little pressure also makes it harder for the tire to roll, and this uses up more fuel.

- Ride comfort and vehicle stability  
The superior riding experience built into your vehicle partly depends on the correct tire pressure. Too much pressure gives an uncomfortable and jarring ride. Too little pressure feels as if your vehicle is slow to respond. Unequal tire pressures can make steering your vehicle uneven and unpredictable.

The tire pressure for your vehicle under normal driving conditions is listed on the placard attached to the driver's door sill.

(Refer to "Tire and loading information placard" on page 11-3.)

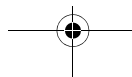

### Tires

The recommended inflation pressures under normal driving conditions should be used for the tires listed below.

Tire size	Front	Rear
P225/55R 18	240 KPA, 35 PSI	240 KPA, 35 PSI

Tire pressures should be checked, and adjusted if necessary, at least once a month.

Pressures should be checked more often whenever weather temperatures change severely, because tire pressures change with outdoor temperatures. The pressures listed are always "cold inflation pressure".

Cold inflation pressure is measured after the vehicle has been parked for at least three hours or is driven less than 1 mile (1.6 km) after having been parked for three hours.

Cold inflation pressure must not go above the maximum values molded into the tire sidewall. After driving several miles, your tire inflation pres-

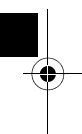
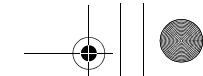

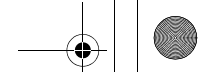

## Tires

sure may increase 2 to 6 psi (14 to 41 kPa) from the cold inflation pressure. Do not let air out of the tires to get back to the specified cold pressure, or your tires will be too low.

Check your tires each time you refuel. If one tire looks lower than the others, check the pressure for all of them.

You should also take the following safety precautions:

**9**

- Keep your tires inflated to the recommended pressures. (See the tire and loading information placard attached to the driver's door sill.)
- Stay within the recommended load limits.
- Make sure that the weight of any load in your vehicle is evenly distributed.
- Drive at safe speeds.
- After filling your tires to the correct pressure, check them for damage and air leaks. Be sure to reinstall the caps on the valve stems.

## Replacing tires and wheels

N00939601495

### CAUTION

- Avoid using different size tires from the one listed and the combined use of different types of tires, as this can affect driving safety. Refer to "Tires and wheels" on page 11-8.
- Always use tires of the same size, same type, and same brand, and which have no wear differences. Using tires that differ in size, type, brand or the degree of wear, will increase the differential oil temperature, resulting in possible damage to the driving system. Further, the drive train will be subjected to excessive loading, possibly leading to oil leakage, component seizure, or other serious problems.
- Only Mitsubishi Motors genuine wheels should be used, because your vehicle is equipped with a tire pressure monitoring system (TPMS). Use of another type of wheel risks air leaks and sensor damage, as it will not be possible to install the tire pressure sensor properly.

### NOTE

- 16 inches steel wheel cannot be used on your vehicle because it interferes with brake parts. Additionally, 16 inches aluminum wheel may not be used on your vehicle depending on its type, even if a Mitsubishi Motors Genuine wheels. Consult a certified Mitsubishi EV dealer before using wheels that you have.

## Tire maintenance

N00939701210

The following maintenance steps are recommended:

- Check tire pressures regularly.
- Have regular maintenance done on the wheel balance and front and rear suspension alignment.
- Rotate your tires regularly as described in the "Tire rotation" section on page 9-19.

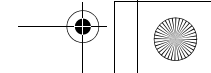
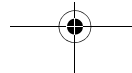

## Tread wear indicator

N00939800184

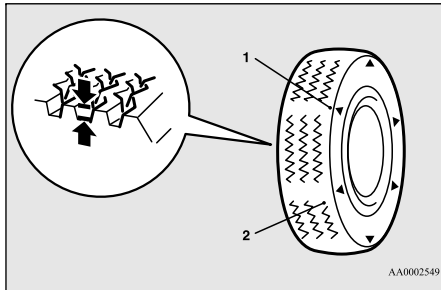

- 1- Location of the tread wear indicator
- 2- Tread wear indicator

Tread wear indicators are built into the original equipment tires on your vehicle to help you know when your tires should be replaced. Many states have laws requiring that you replace your tires at this point.

These indicators are molded into the bottom of the tread grooves and will appear when the tire tread is worn down to 1/16 inch (1.6 mm).

When the bands appear next to one another in two or more places, replace your tires.

### NOTE

- Tire wear indicators can have different marks and locations depending on the tire manufacturer.

## Tire rotation

N00939901599

To even out the wear on your tires and make them last longer, Mitsubishi Motors Corporation recommends that you rotate your tires at the mileage listed in the “WARRANTY AND MAINTENANCE MANUAL”.

However, the timing for tire rotation may vary according to your vehicle condition, road surface conditions, and your own personal driving habits. Any time you notice unusual wear, rotate your tires as soon as possible.

When rotating tires, check for uneven wear, damage, and wheel alignment. Abnormal wear is usually caused by a wrong tire pressure, wheels that are not aligned properly, wheels that are out-of-balance, or severe braking.

Check with a certified Mitsubishi EV dealer to find out the reason for uneven tread wear.

## Tires

The first tire rotation is the most important one. It will allow all your tires to wear evenly.

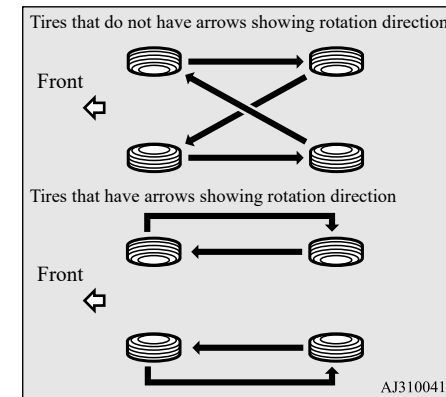

## Tires

### ⚠ CAUTION

- If the tires have arrows (A) indicating the correct direction of rotation, swap the front and rear tires on the left-hand side of the vehicle and the front and rear tires on the right-hand side of the vehicle separately. Keep each tire on its original side of the vehicle. When installing the tires, make sure the arrows point in the direction in which the wheels will turn when the vehicle moves forward. Any tire whose arrow points in the wrong direction will not perform to its full potential.

9

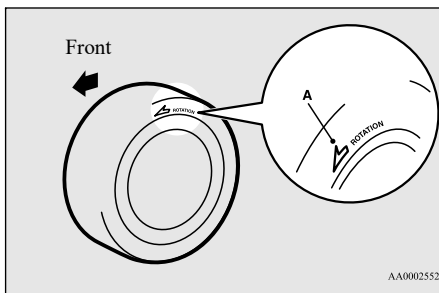

### ⚠ CAUTION

- Avoid the combined use of different types of tires. Using different types of tires can affect vehicle performance and safety.

### Snow tires

N00940001457

In some areas of the country, snow tires are required for winter driving. If snow tires are required in your area, you must choose snow tires of the same size and type as the original tires provided with your vehicle. Snow tires should also be installed on all four wheels. Otherwise your safety and vehicle handling can be reduced.

Even where laws may permit it, snow tires should not be operated at sustained speeds over 75 mph (120 km/h).

### ⚠ CAUTION

- Your vehicle uses the flange nuts. Change to tapered nuts when using snow tires with steel wheels.

### ⚠ CAUTION

- Only Mitsubishi Motors genuine wheels should be used, because your vehicle is equipped with a tire pressure monitoring system (TPMS). Use of another type of wheel risks air leaks and sensor damage, as it will not be possible to install the tire pressure sensor properly.

### Tire chains

N00940101139

### ⚠ CAUTION

- Tire chains cannot be used on your vehicle. The clearance between the chains and the body is not sufficient to allow proper clearance, and the vehicle body might be damaged.

## Brake pedal free play

N00940301359

To check the brake pedal free play (A), turn off the Plug-in Hybrid EV system and press the brake pedal several times with your foot. Then press the pedal down with your fingers until you first feel resistance.

Brake pedal free play:  
**.1 to .3 inch (3 to 8 mm)**

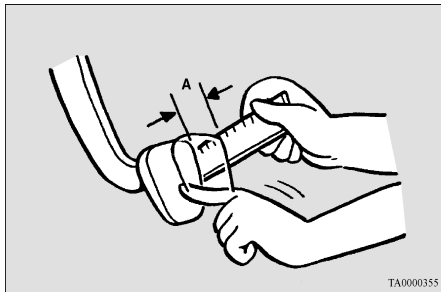

TA0000355

If the free play is not within these limits, take your vehicle to a certified Mitsubishi EV dealer for adjustment.

## Wiper blades

N00940700138

Check the wiper blades occasionally. Clean them regularly to remove deposits of salt and road film. Use a sponge or cloth and a mild

detergent or non-abrasive cleaner to clean the blades and glass areas.

Replace the blades if they continue to streak or smear.

### NOTE

- Do not run the wipers on dry glass for a long time. This wears out the rubber and can scratch the glass.

## During cold weather

If the blades are frozen to the windshield or rear window, do not operate the wipers until the ice has melted and the blades are freed, otherwise the wiper motor may be damaged.

## Emission-control system maintenance

N00940801338

Your vehicle is equipped with an emission-control system that meets all the requirements of the U.S. Environmental Protection Agency and Environment Canada. The emission-control system is made of:

- a positive crankcase ventilation system
- an evaporative emission-control system
- an exhaust emission-control system

## Brake pedal free play

To be sure the emission-control system works properly, have your vehicle inspected and maintained by a certified Mitsubishi EV dealer. This should be done at the time or mileage specified in the “WARRANTY AND MAINTENANCE MANUAL”.

These, and all the other “general” maintenance services listed in this manual, need to be performed to keep your vehicle running properly and reliably.

You should also have an inspection and service any time you suspect a malfunction.

### NOTE

- To meet government regulations and promote cleaner air, your vehicle is equipped with an onboard diagnostic system (OBD). The engine electronic control module that controls OBD functions stores various data (especially about the exhaust emissions). This data will be erased if the battery cable is disconnected, which could make a rapid diagnosis difficult. Do not disconnect the battery cable when the engine malfunction indicator (“SERVICE ENGINE SOON” or “Check engine light”) is ON.

9

## Spark plugs

N00940900231

Spark plugs must fire properly to ensure proper engine performance and emission-control.

Vehicle care and maintenance 9-21



## General maintenance

Do not reuse spark plugs by cleaning or regapping. Spark plugs should be replaced at the mileage specified in the “WARRANTY AND MAINTENANCE MANUAL”.

### NOTE

- Use the recommended or equivalent spark plugs listed under “Engine specifications” on page 11-6. Use of other plugs could cause engine damage, loss of performance or radio noise.

## Fuel hoses

N0094100040

9

Check the hose surfaces for any heat and mechanical damage, hard and brittle rubber, cracking, tears, cuts and abrasions. Pay special attention to the hoses closest to high heat sources such as the exhaust manifold. Check all the hose connections, such as clamps and couplings, to make sure they are secure and that there are no leaks. If you see any wear or damage, replace the hoses immediately.

## Intake valve clearance

N00950101060

Have the valve clearance checked at a certified Mitsubishi EV dealer at the mileage specified in the “WARRANTY AND MAINTENANCE MANUAL”.

9-22 Vehicle care and maintenance



If the engine sounds abnormally loud, have adjustments made by a certified Mitsubishi EV dealer.

## Fuel system (tank, pipe line and connection, and fuel tank filler cap)

N00941301196

Check these regularly for damage or leaks in the fuel lines and connections. Check the fuel tank filler cap for damage or looseness. Pay special attention to the fuel lines closest to high heat sources such as the exhaust manifold.

### WARNING

- **If you see a fuel leak or if you smell fuel, do not start the Plug-in Hybrid EV system. Any spark (including from the ignition), flame or smoking material could cause an explosion or fire. Call a certified Mitsubishi EV dealer for assistance.**

## Evaporative emission control system (except evaporative emission canister)

N00941401197

If the fuel-vapor vent line is clogged or damaged, the fuel-vapor mixture will escape, polluting the air.

Have the system checked at a certified Mitsubishi EV dealer at the mileage specified in the “WARRANTY AND MAINTENANCE MANUAL”.

### NOTE

- Approximately 6 hours after the Plug-in Hybrid EV system is turned off, you may hear operating sounds from under the vehicle for several minutes. This is the sound checking the fuel evaporation leakage. This is normal.

## General maintenance

N00941501303

The next pages list the maintenance service recommended by Mitsubishi Motors Corporation. In addition to the general maintenance that needs to be performed at the times listed, there are other parts which do not usually need regular maintenance.

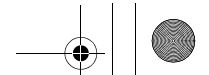

But, if any of these parts stops working properly, your vehicle performance could suffer. Have these items checked if you notice a problem with them.

If you have any questions, see a certified Mitsubishi EV dealer for assistance.

### Disc brake pads

N00941600059

Good brakes are essential for safe driving. Check the brake pads for wear. For good braking performance, replace the brake pads with the same type pads as the originals.

### Brake hoses

N00941700076

Brake hoses and tubing should be checked for:

- Severe surface cracking, scuffing or worn spots. If the fabric casing of the hose is showing through any cracks or worn spots in the rubber hose cover, the hose should be replaced. The brakes can fail if the hose wears through.
- Improper installation may cause twisting, or wheel, tire or chassis interference.

### Ball joint, steering linkage seals, drive shaft boots

N00941800093

Check the following parts for damage and grease leaks:

- Ball joint boots of the suspension and steering linkage
- Bellows on both ends of the drive shaft

### Exhaust system

N00942201118

#### ⚠ WARNING

- Carbon monoxide gas from your vehicle's exhaust is poisonous. Breathing these fumes can cause unconsciousness or death.

The best way to keep carbon monoxide gas from entering inside your vehicle is to have the engine exhaust system properly serviced. Have a competent mechanic inspect the complete exhaust system and nearby body areas for broken, damaged, deteriorated, or mispositioned parts if you notice any of the following:

- A change in the sound of the exhaust system
- The smell of exhaust fumes inside the vehicle

## General maintenance

- The underside or rear of the vehicle is damaged

Also check the exhaust system each time the vehicle is raised for lubrication, oil changes, or required service. Any open seams or loose connections could let dangerous exhaust fumes seep into the luggage and passenger compartments.

### Check for any of the following conditions:

- Check for holes or exhaust gas leaks caused by corrosion or damage.
- Check the joints and connections for looseness or exhaust gas leaks.
- Check the rubber hangers and brackets for damage.

9

### Timing belt

N00942300079

The timing belt should be replaced with a new one at the mileage listed in the "WARRANTY AND MAINTENANCE MANUAL".



For cold and snowy weather

### Hood lock release mechanism and safety catch

N00942501124

The hood lock release mechanism and hood safety catch should be checked, cleaned, and oiled when needed for easy movement and to prevent rust and wear. Use Multipurpose Grease NLGI Grade 2 sparingly for all sliding parts of the hood latch and release lever. Work the grease into the hood lock mechanism until all the movable surfaces are covered.

Also, put a light coat of the same grease on the safety catch wherever moving parts touch.

9

### For cold and snowy weather

N00942600102

### Ventilation slots

The ventilation slots in front of the windshield should be brushed clear after a heavy snowfall so that the operation of the heating and ventilation systems will not be impaired.



9-24 Vehicle care and maintenance



### Weatherstripping

To prevent freezing of the weatherstripping on the doors, engine hood, etc., they should be treated with silicone grease.

### Additional equipment (For regions where snow is encountered)

It is a good idea to carry a shovel or a short-handled spade in the vehicle during the winter so that you can clear away snow if you get stranded. A small hand-brush for sweeping snow off the vehicle and a plastic scraper for the windshield, side and rear window are also useful.

### Fusible links

N00942701331

The fusible links will melt to prevent a fire if a large current attempts to flow through certain electrical systems.

In case of a melted fusible link, see a certified Mitsubishi EV dealer for inspection and replacement.

For the fusible links, please refer to "Fuse load capacities" on page 9-26.

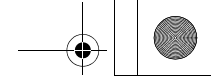
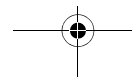

### WARNING

- Fusible links must not be replaced by any other device. Failing to fit the correct fusible link may result in fire in the vehicle, property destruction and serious or fatal injuries at any time.

### Fuses

N00942801938

### Fuse block location

To prevent damage to the electrical system from short-circuiting or overloading, each individual circuit is equipped with a fuse. The fuse blocks are located in the passenger compartment and in the engine compartment.





### Passenger compartment

The fuse blocks in the passenger compartment are located behind the fuse lid in front of the driver's seat at the position shown in the illustration.

Pull the fuse lid to remove it.

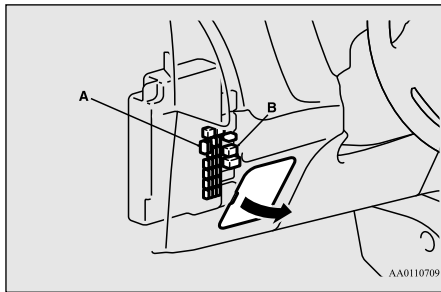

A- Main fuse block  
B- Sub fuse block

### Engine compartment

In the engine compartment, the fuse blocks are located as shown in the illustration. While pressing the tab (C), pull up the cover.

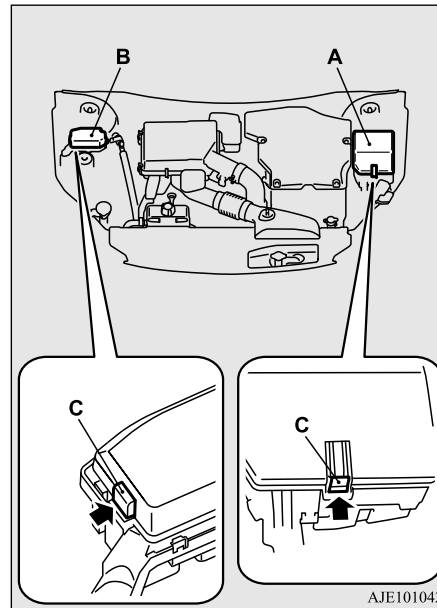

A- Main fuse block  
B- Sub fuse block

## Fuses

### Fuse load capacities

N00954801472

This fuse list shows the names of the electrical systems and their fuse capacities.

There are spare fuses in the main fuse block cover in the engine compartment. Always replace a blown fuse with one of the same capacity as the original.

### Passenger compartment fuse location table

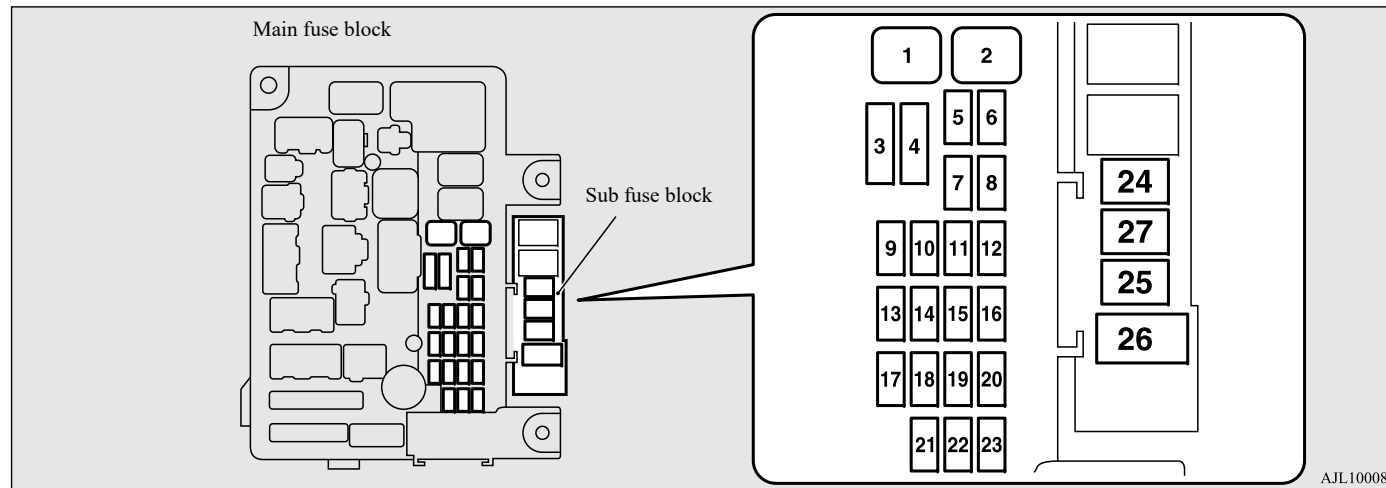

AJL100086

No.	Sym- bol	Electrical system	Capac- ity
1		Power window control	30 A*
2		Defogger	30 A*

No.	Sym- bol	Electrical system	Capac- ity
3		Heater	30 A
4		Windshield wipers	30 A

No.	Sym- bol	Electrical system	Capac- ity
5		Door locks	20 A
6		Rear fog light	10 A

Fuses

No.	Symbol	Electrical system	Capacity
7		12 V power outlet	15 A
8		Rear window wiper	15 A
9		Sunroof	20 A
10		Power switch	10 A
11		Option	10 A
12		Hazard warning flasher	15 A
13		4-wheel drive system	10 A
14	STOP	Stop lights (Brake lights)	15 A
15		Gauges	10 A
16		SRS airbag	7.5 A
17		Radio	15 A
18		Control unit relay	7.5 A
19		Interior lights (Room lights)	15 A
20		Back-up lights	7.5 A
21		Heated outside rearview mirrors	7.5 A
22		Outside rearview mirrors	10 A

No.	Symbol	Electrical system	Capacity
23		Cigarette lighter/ 12 V power outlet	15 A
24		Charge	7.5 A
		Heated steering wheel	15 A
25		Power seat (Driver seat)	30 A*
26		Heated seats	30 A
27		Power seat (Passenger seat)	30 A*

\*: Fusible link

- Some fuses may not be installed on your vehicle, depending on the vehicle model or specifications.
- The table above shows the main equipment corresponding to each fuse.

Engine compartment fuse location table

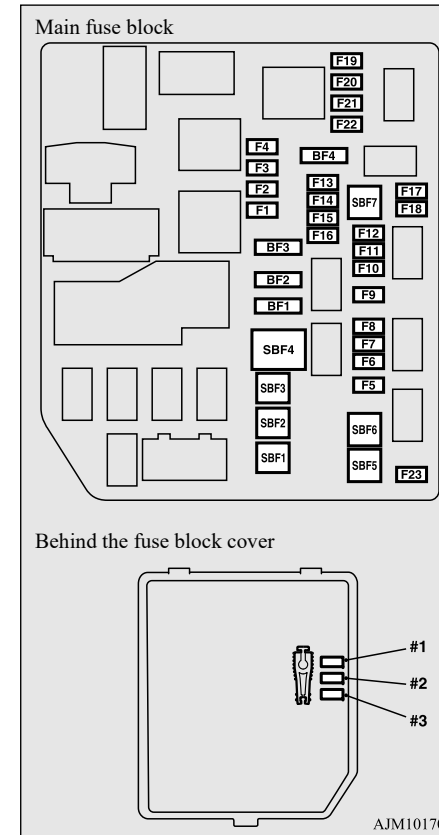

Fuses

No.	Symbol	Electrical system	Capacity
SBF1		Air conditioning condenser fan motor	30 A*
SBF2	—	—	—
SBF3	—	—	—
SBF4		Radiator fan motor	40 A*
SBF5		Anti-lock braking system	40 A*
SBF6	—	—	—
SBF7		Anti-lock braking system	30 A*
BF1	PIGATE	Power liftgate	30 A
BF2		Audio system amplifier	30 A
BF3	IOD	IOD	30 A
BF4	—	—	—
F1	—	—	—
F2		Wiper deicer	15 A
F3		Electric parking brake	7.5 A
F4		Daytime running lights	10 A
F5		Front fog lights	15 A

No.	Symbol	Electrical system	Capacity
F6		Heated steering wheel	15 A
F7		Headlight washer	20 A
F8		Security horn	20 A
F9		Horn	10 A
F10		ETV	15 A
F11		Charging lid lock	15 A
F12		Engine	7.5 A
F13		ENG/POWER	20 A
F14		Fuel pump	15 A
F15		Ignition coil	10 A
F16	—	—	—
F17		Headlight (high beam) (left)	10 A
F18		Headlight (high beam) (right)	10 A
F19		Headlight (low beam) (left)	LED 20 A

No.	Symbol	Electrical system	Capacity
F20		Headlight (low beam) (right) LED	20 A
F21		Headlight (low beam) (left) Halogen	10 A
F22		Headlight (low beam) (right) Halogen	10 A
F23	—	—	—
#1	—	Spare fuse	10 A
#2	—	Spare fuse	15 A
#3	—	Spare fuse	20 A

\*: Fusible link

- Some fuses may not be installed on your vehicle, depending on the vehicle model or specifications.
- The table above shows the main equipment corresponding to each fuse.

Fuses

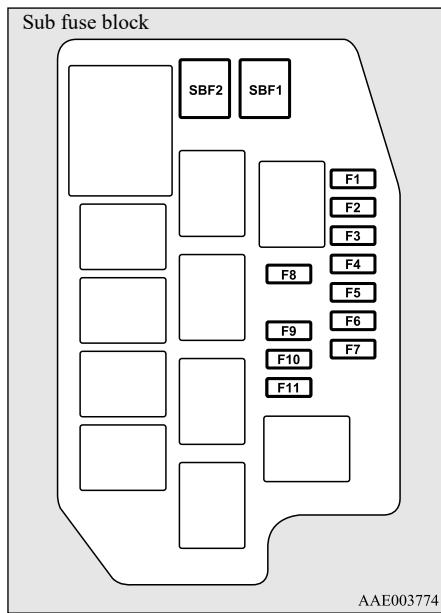

No.	Symbol	Electrical system	Capacity
SBF1		Electrical Parking Lock	30 A*
SBF2		Vacuum pump (Regenerative brake)	30 A*
F1		Water pump (Electric motor)	20 A

No.	Symbol	Electrical system	Capacity
F2		Battery management unit	7.5 A
F3		Main drive lithium-ion battery PTC heater	15 A
F4		Fuel tank filler door	7.5 A
F5		Solenoid valve (Air conditioning)	7.5 A
F6		Water pump (Air conditioning)	7.5 A
F7		Electric motor unit control	10 A
F8		Heated windshield	7.5 A
F9		Power feeder and charger connector (12V)	10 A
		Main drive lithium-ion battery fan motor	15 A
F10		Ignition control	15 A
F11		Ignition control	7.5 A

\*: Fusible link

- Some fuses may not be installed on your vehicle, depending on the vehicle model or specifications.
- The table above shows the main equipment corresponding to each fuse.

The fuse block does not contain spare 7.5 A, 25 A or 30 A fuses. If one of these fuses burns out, substitute with the following fuse.

**7.5 A: 10 A spare fuse**

**25 A: 20 A spare fuse**

**30 A: 30 A audio system amplifier fuse**

When using a substitute fuse, replace with a fuse of the correct capacity as soon as possible.

9

Identification of fuse

Capacity	Color
7.5 A	Brown
10 A	Red
15 A	Blue
20 A	Yellow
30 A	Green (fuse type) / Pink (fusible link type)
40 A	Green (fusible link type)

## Replacement of light bulbs

### Fuse replacement

N00954901154

1. Before replacing a fuse, always turn off the electrical item connected to the fuse and put the operation mode of the power switch in OFF.
2. There is a fuse remover (A) in the engine compartment fuse block.

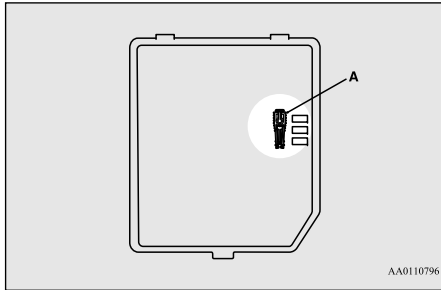

3. Clamp it on the fuse you wish to remove, and pull the fuse straight out from the fuse block.

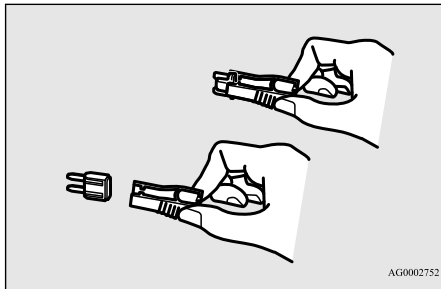

4. Use the fuse location diagrams and the matching tables, to check the fuse that is related to the problem. If the fuse is not blown, something else must be causing the problem. Have the system inspected by a certified Mitsubishi EV dealer.

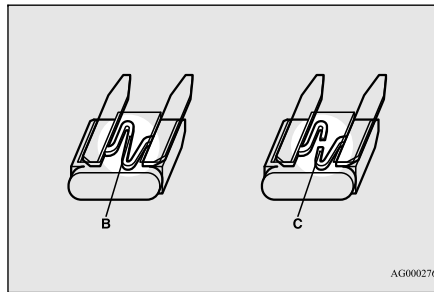

- B- Fuse is OK
- C- Blown fuse

5. Insert a new fuse of the same capacity securely into the appropriate slot.

### CAUTION

- Never use a fuse with a capacity greater than the one listed or any substitute, such as wire, foil etc. This would cause the circuit wiring to heat up and could cause a fire.
- If the replacement fuse blows again after a short time, have the electrical system checked by a certified Mitsubishi EV dealer to find and correct the cause.

### Replacement of light bulbs

N00942901388

Before replacing the bulb, be sure the light is off. Do not touch the glass part of the new bulb with your bare fingers; the oil from your skin will stay on the glass and dim or destroy the bulb when it gets hot.

### CAUTION

- Bulbs are extremely hot immediately after being turned off. When replacing the bulb, wait for it to cool sufficiently before touching it. You could otherwise be burned.
- Handle halogen light bulb with care. The gas inside a halogen light bulb is highly pressurized, so dropping, knocking, or scratching a halogen light bulb can cause it to shatter.
- Never hold the halogen light bulb with a bare hand, dirty glove, etc. The oil from your hand could cause the bulb to break the next time the headlights are used. If the glass surface is dirty, clean it with alcohol and let it dry completely before installing the bulb.

## Replacement of light bulbs

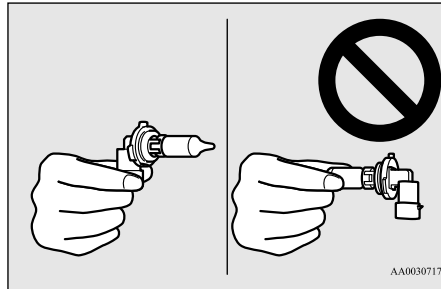

AA0030717

### CAUTION

- Do not install commercially available LED-type bulbs. Commercially available LED-type bulbs could adversely affect the operation of the vehicle, such as by preventing the lights and other vehicle equipment from operating properly.

### NOTE

- If you are unsure of how to carry out the work as required, it is recommended that these procedures be carried out by a certified Mitsubishi EV dealer.
- Be careful not to scratch the vehicle body when removing a light and lens.

### NOTE

- When it rains, or when the vehicle has been washed, the inside of the lens sometimes becomes temporarily foggy. This is the same phenomenon as when window glass mists up on a humid day, and does not indicate a functional problem. When the light is switched on, the heat will remove the fog. However, if water gathers inside the light, please have it checked by a certified Mitsubishi EV dealer.

### Bulb location and capacity

N00943001201

### CAUTION

- When replacing a bulb, be sure to use a new bulb of the same type, wattage, and color. If you install a different bulb, the bulb could malfunction or fail to come on and could lead to a vehicle fire.

### Outside

N00950302160

Front

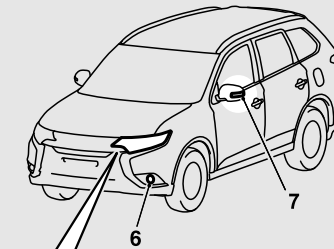

Type A

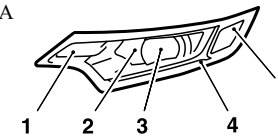

Type B



AJE101550

Type A: Halogen headlights type  
Type B: LED headlights type

### Replacement of light bulbs

Item		Wattage	ANSI Trade No. or Bulb type
1 - Front turn signal light		21 W	PY21W
2 - Head-light, high beam	Halogen bulb	60 W	9005 HB3
	LED	—	—
3 - Head-light, low beam	Halogen bulb	55 W	H7
	LED	—	—
4 - Parking light/Daytime running light		—	—
5 - Front side-marker light		5 W	W5W
6 - Front fog light	Halogen bulb	19 W	H16
	LED	—	—
7 - Side turn signal light		—	—

NOTE			
<ul style="list-style-type: none"> <li>The following lights use an LED-type bulb. Check with a certified Mitsubishi EV dealer when either light needs to be repaired or replaced.</li> <li>Headlight, high beam/low beam (LED type)</li> </ul>			

NOTE	
<ul style="list-style-type: none"> <li>Parking light</li> <li>Daytime running light</li> <li>Front fog light (LED type)</li> <li>Side turn signal light</li> </ul>	

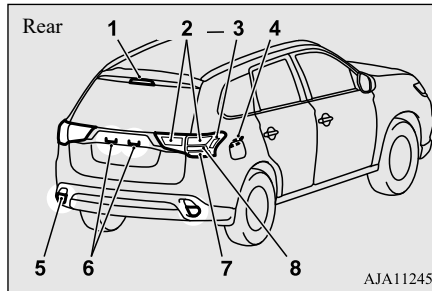

Item	Wattage	ANSI trade No. or Bulb type
1 - High-mounted stop light	—	—
2 - Tail light	—	—
3 - Rear side-marker light	—	—
4 - Charging port courtesy light	5 W	W5W
5 - Back-up light	16 W	W16W

Item	Wattage	ANSI trade No. or Bulb type
6 - License plate light	5 W	W5W
7 - Rear turn signal light	21 W	WY21W
8 - Stop light	—	—

NOTE	
<ul style="list-style-type: none"> <li>The following lights use an LED-type bulb. Check with a certified Mitsubishi EV dealer when either light needs to be repaired or replaced.</li> <li>Rear side-marker light</li> <li>High-mounted stop light</li> <li>Tail light</li> <li>Stop light</li> </ul>	



### Inside

N00950401845

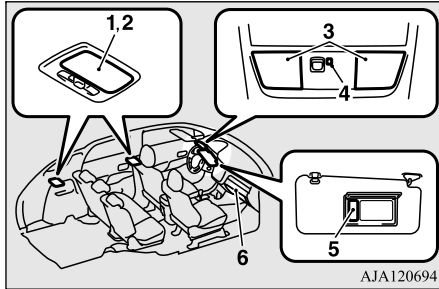

Item	Wattage
1 - Cargo room light	8 W
2 - Dome light (rear)	8 W
3 - Dome light (front)/Reading light	8 W
4 - Downlight	-
5 - Vanity mirror lights	2 W
6 - Glove compartment light	1.4 W

### NOTE

- The following lights use an LED-type bulb. Check with a certified Mitsubishi EV dealer when the light needs to be repaired or replaced.
  - Downlight
  - Front foot lights

### Headlights (low beam, halogen bulb type)

N00901801258

1. When replacing the bulb on the left side of the vehicle, remove the bolt (A) holding down the relay box and move the relay box.

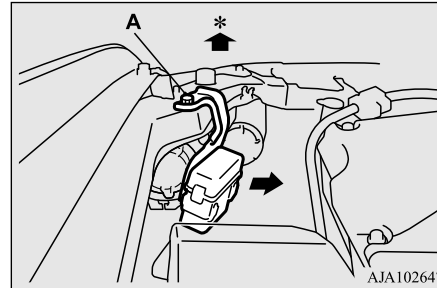

\*: Front of the vehicle

### Replacement of light bulbs

2. Turn the cap (B) counterclockwise to remove it.

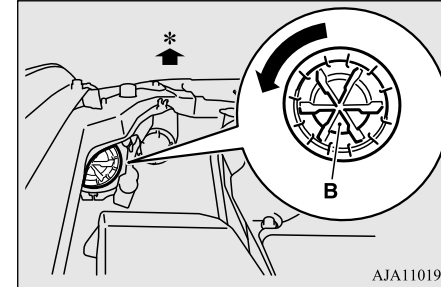

\*: Front of the vehicle

3. Turn the socket (C) counterclockwise to remove it, and then pull the bulb out of the socket.

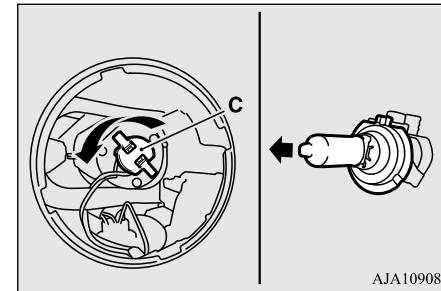

## Replacement of light bulbs

4. To install the bulb, perform the removal steps in reverse.

### NOTE

- When installing the bulb, align the tab (D) with the notch (E) of the socket.

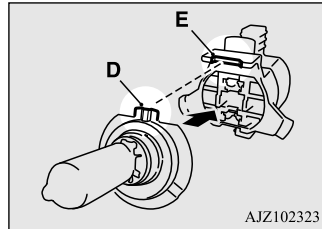

9

## Headlights (high beam, halogen bulb type)

N00901901187

1. When replacing the bulb on the right side of the vehicle, remove the clip (A) holding down the washer tank spout and then move it.

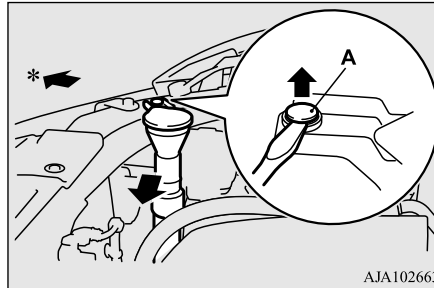

\*: Front of the vehicle

2. Turn the cap (B) counterclockwise to remove it.

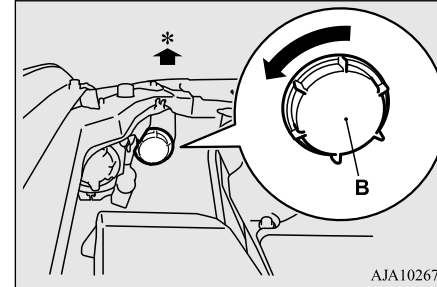

\*: Front of the vehicle

3. Turn the bulb (C) counterclockwise to remove it and then while holding down the tab (D), pull out the bulb (E).

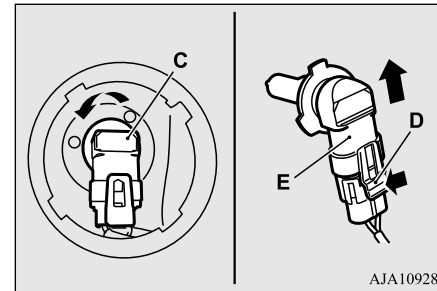

4. To install the bulb, perform the removal steps in reverse.

## Replacement of light bulbs

### Headlights (high beam/low beam, LED type)

N00943101909

#### NOTE

- The headlights use an LED-type bulb. Check with a certified Mitsubishi EV dealer when the light needs to be repaired or replaced.

### Headlight aim adjustment

N00943201375

The alignment of the headlights should be checked by a certified Mitsubishi EV dealer.

### Front side-marker lights

N00915501230

1. When replacing the bulb on the left side of the vehicle, move the relay box. (Refer to “Headlight (low beam, halogen bulb type): Step 1” on page 9-33.

2. Turn the socket (A) counterclockwise to remove it, and then pull the bulb out of the socket.

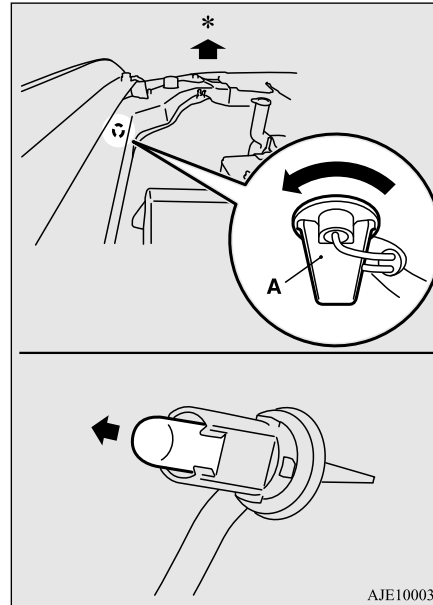

\*: Front of the vehicle

3. To install the bulb, perform the removal steps in reverse.

### Parking lights/Daytime running lights

N00917301782

#### NOTE

- The parking lights and daytime running lights use an LED-type bulb. Check with a certified Mitsubishi EV dealer when the light needs to be repaired or replaced.

### Front turn signal lights

N00943401449

#### CAUTION

- Make sure that the Plug-in Hybrid EV system have cooled down before replacing the bulb on the right side of the vehicle, otherwise you could be burnt by the radiator hose.

### Replacement of light bulbs

1. Remove the 12 clips (A, B), and then remove the cover (C).

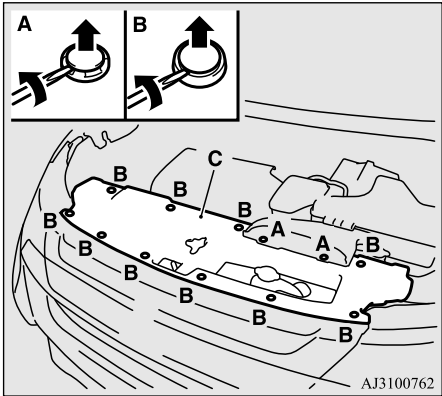

9

2. Turn the socket (D) counterclockwise to remove it, then remove the bulb from the socket by turning it counterclockwise while pressing in.

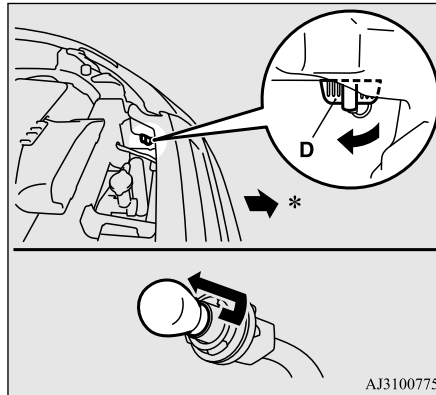

\*: Front of the vehicle

3. To install the bulb, perform the removal steps in reverse.

### Side turn signal lights

N00943501219

#### NOTE

- The side turn signal lights use an LED-type bulb. Check with a certified Mitsubishi EV dealer when the light needs to be repaired or replaced.

### Front fog lights (Halogen bulb type)

N00943601887

1. Insert a straight blade (or minus) screwdriver with a cloth over its tip at the points indicated by arrows and pry gently to remove the cover (A).

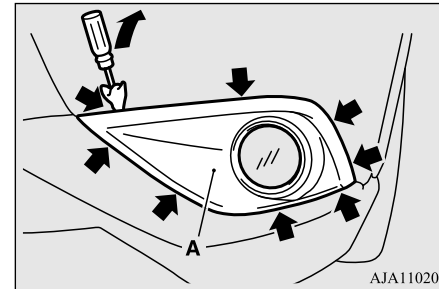

## Replacement of light bulbs

2. Remove the 3 screws (B) and remove the light unit.

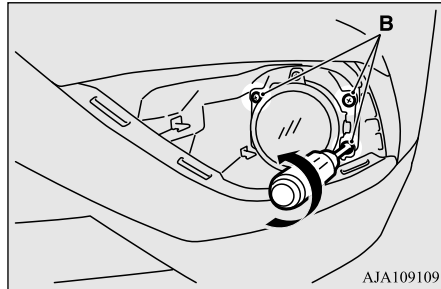

3. While holding down the tab (D), pull out the socket (E).

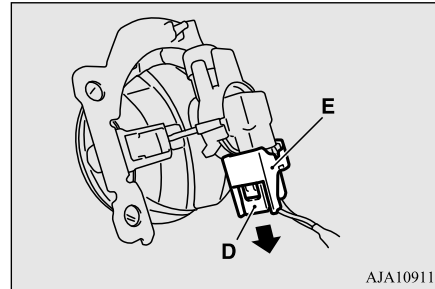

### Front fog lights (LED type)

N00943602015

#### NOTE

- The fog lights use an LED-type bulb. Check with a certified Mitsubishi EV dealer when the light needs to be repaired or replaced.

#### NOTE

- When unfastening the screws or the fog light, be careful not to move the beam position adjustment screw (C).

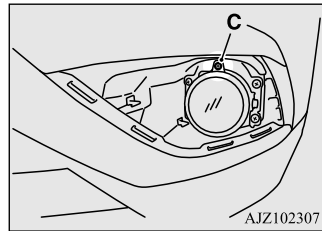

4. Turn the bulb (F) counterclockwise to remove it.

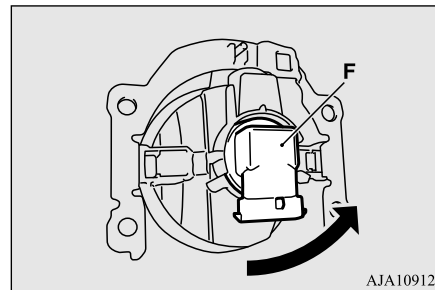

### Rear combination lights

N00943701644

1. Open the liftgate.
2. Remove the screws (A), and then move the light unit toward the rear of the vehicle to unfix the notch (B) and pins (C).

9

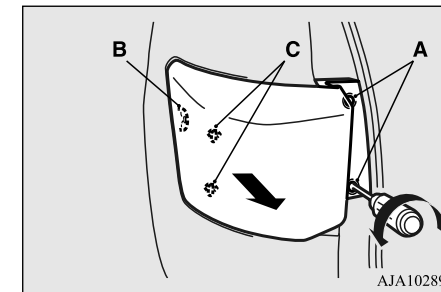

5. To install the bulb, perform the removal steps in reverse.

## Replacement of light bulbs

3. Turn the socket counterclockwise and remove it, and then pull the bulb out of the socket.

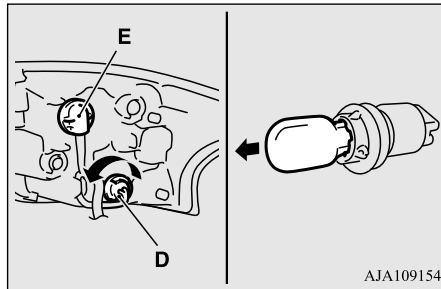

9

D- Rear turn signal light  
E- Tail light and stop light (LED) - cannot be replaced

### NOTE

- The rear side-marker light, tail light and stop light use an LED-type bulb. Check with a certified Mitsubishi EV dealer when the light needs to be repaired or replaced.

4. To install the bulb, perform the removal steps in reverse.

### NOTE

- When mounting the light unit, align the notch (F) and pin (G) on the light unit with the clip (H) and hole (I) in the body.

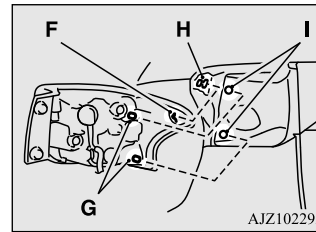

## Back-up lights

N00929101080

1. Push the light unit upward to remove it.

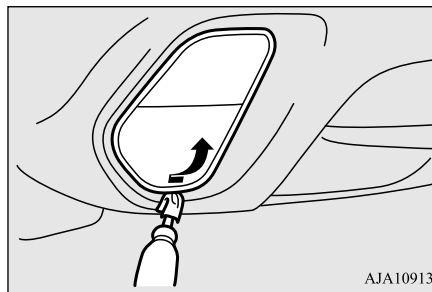

### NOTE

- Wrap a cloth around the tip of the screwdriver to keep from scratching the lens.

2. Turn the socket (A) counterclockwise to remove it, and then pull the bulb out of the socket.

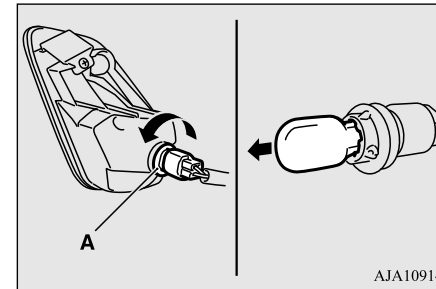

3. To install the bulb, perform the removal steps in reverse.

### NOTE

- When installing the light unit, first insert the notch (B) into the hole on the body, and then push on the light unit to fit it into place.

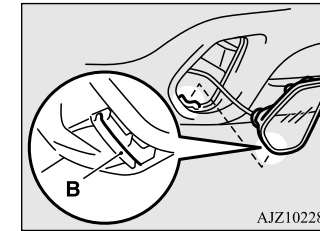

## Vehicle care precautions

### License plate lights

N00944001468

1. When removing the light unit (A), push it toward the left side of the vehicle body.

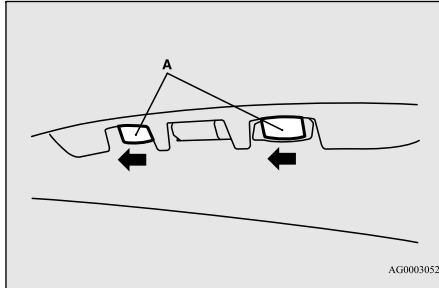

2. Use a screw driver to gently pry up the tab (B) and remove the lens.

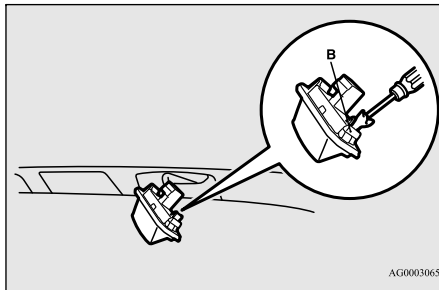

#### NOTE

- Wrap a cloth around the tip of the screwdriver to keep from scratching the lens.

3. Pull the bulb out of the socket.

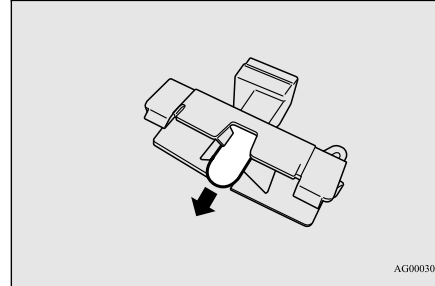

4. To install the bulb, perform the removal steps in reverse.

#### NOTE

- When mounting the light unit, insert tab (C) first then align tab (D) with its hole.

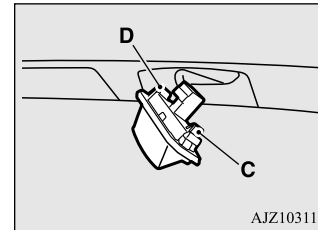

### High-mounted stop light

N00943901170

#### NOTE

- The high-mounted stop light uses an LED-type bulb. Check with a certified Mitsubishi EV dealer when the light needs to be repaired or replaced.

### Vehicle care precautions

N00945101206

In order to maintain the value of your vehicle, perform regular maintenance using the proper materials and procedures. Be sure to use only those materials and procedures that meet your local environmental pollution control regulations. Choose the materials you will use carefully, to be sure that they do not contain corrosives. If you are not sure, contact a certified Mitsubishi EV dealer for help in choosing these materials.

## Cleaning the inside of your vehicle

### CAUTION

● Cleaning products can be dangerous. Some are poisonous and others are highly flammable. Some are dangerous if you breathe their fumes in a closed space. When you use anything in a container to clean your vehicle, be sure to follow the instructions. Always open your vehicle doors or windows when you're cleaning the inside. Never use the following chemicals to clean your vehicle:

- Gasoline
- Carbon Tetrachloride
- Benzine
- Kerosene
- Naphtha
- Acetone
- Turpentine
- Paint Thinner
- Lacquer Thinner
- Nail Polish Remover

9

These can all be dangerous, and they all can damage your vehicle.

### Cleaning the inside of your vehicle

N00945201119

After washing the inside of your vehicle with any cleaner, wipe it dry in a shady, well ventilated area.

### CAUTION

- Do not use organic substances (solvents, benzine, kerosene, alcohol, gasoline, etc.) or alkaline or acidic solutions. These chemicals can cause discoloring, staining or cracking of the surface. If you use cleaners or polishing agents, make sure their ingredients do not include the substances mentioned above.
- When cleaning the meter cluster panel, use a cloth and be careful not to injure your hands.

### NOTE

- Always read the instructions on the cleaner label.

### Plastic, vinyl leather, fabric and flocked parts

N00945301224

1. Lightly wipe these off with a soft cloth soaked in a 3% solution of gentle soap and water.
2. To rinse, dip the cloth in fresh water, wring it out well, and wipe off all the soap.

### NOTE

- Do not use cleaners, conditioners, and protectants containing silicones or wax. Such products, when applied to the instrument panels or other parts, may cause reflections on the windshield and obscure vision. Also, if such products get on the switches of the electrical accessories, it may lead to failure of these accessories.
- Do not use synthetic fiber or dry cloth. They can cause discolouring or damaging the surface.
- Do not place a deodorizer on the instrument panel or near lights and instruments. The ingredients for deodorizer can cause discolouring or cracking.

### Upholstery

N00945500128

1. To maintain the value of your new vehicle, maintain the upholstery carefully and keep the interior clean. Use a vacuum cleaner and brush to clean the seats. If stained, vinyl and synthetic leather should be cleaned with an appropriate cleaner. Cloth fabrics can be cleaned with either upholstery cleaner or a 3% solution of gentle soap in lukewarm water.



2. Clean the carpeting with a vacuum cleaner and remove any stains with carpet cleaner. Oil and grease can be removed by lightly dabbing with a clean white cloth and spot remover.

#### NOTE

- If fuzzing is difficult to remove from the seat upholstery, draw a suitable defuzzing brush over the surface in one direction.

### Genuine leather (if so equipped)

N00945600187

1. To clean, lightly wipe the leather with a soft cloth soaked in a 5% solution of gentle soap and water.
2. To rinse, dip the cloth in fresh water, wring it out well, and wipe off all the soap.
3. To preserve and protect, use a leather protecting agent on the genuine leather surface.

#### NOTE

- If genuine leather is wet with water, wipe it with a dry, soft cloth. If left damp, mildew may grow.
- The genuine leather surface can be damaged if brushed with a nylon or synthetic fiber brush.

#### NOTE

- Organic solvents such as benzene, kerosene, alcohol, gasoline, or acid or alkaline solvents can discolor the genuine leather surface and should not be used.
- Genuine leather can mildew if not kept clean. Clean up any oil stains immediately.
- The genuine leather surface may harden and shrink if it is exposed to the direct sunlight for long hours. When your vehicle is parked, place it in the shade as much as possible.
- When the temperature of the vehicle interior rises in summer, vinyl products left on the genuine leather seat may deteriorate and stick to the seat.

### Cleaning the outside of your vehicle

N00945700058

To protect your vehicle's finish, wash it often and thoroughly. If desired, you may wax your vehicle using a nonabrasive automobile wax.

#### Foreign material

N00945800033

Industrial pollution, road tar, bird droppings, tree sap, insect remains, sea water and other foreign matters can damage the finish on your vehicle.

Generally, the longer any foreign material stays on the finish, the worse the damage.

### Cleaning the outside of your vehicle

Wash your vehicle as soon as possible whenever the finish gets soiled.

#### Washing

N00945901741

Chemicals contained in the dirt and dust picked up from air, rain, snow, or road surfaces can damage the paint and body of your vehicle if left on.

Frequent washing and waxing is the best way to protect your vehicle from this damage.

Do not wash the vehicle in direct sunlight. Park the vehicle in the shade and spray it with water to remove dust. Next, using plenty of clean water and a car washing mitt or sponge, wash the vehicle from top to bottom.

Use a mild car washing soap if necessary. Rinse thoroughly and wipe dry with a chambray or soft cloth. After washing the vehicle, carefully clean the joints and flanges of the doors, hood, etc., where dirt is likely to remain.

9

#### WARNING

- Do not wash the vehicle while charging the main drive lithium-ion battery. Doing so could cause a fire or an electric shock.
- Before washing the vehicle, make sure that the charging lid and the inner lid are completely closed. If the lid is open, the charging unit is exposed to water, resulting in a fire or an electric shock.

Vehicle care and maintenance 9-41

## Cleaning the outside of your vehicle

### ⚠ CAUTION

- When washing the vehicle, Put the operation mode of the power switch in OFF.
- Do not use a high pressure washing machine to clean the underneath of the vehicle. Doing so might cause the front motor and rear motor problem or malfunction.
- When washing the underside of your vehicle or the wheels, wear a pair of gloves to protect your hands.
- If your vehicle has rain sensor, place the wiper switch lever in the "OFF" position to deactivate the rain sensor before washing the vehicle. Otherwise, the wipers will operate in the presence of water spray on the windshield and may get damaged as a result.
- Never spray or splash water on the electrical parts in the engine compartment. This may damage them. Be careful also when washing the underbody to ensure that water does not enter the engine compartment.
- Avoid automatic car washers that use rotating brushes. These brushes may scratch the paint surface and make it dull. Scratches are more noticeable on darker colored vehicles.
- Some hot water washing equipment uses high pressure and heat to clean your vehicle. Because hot water can damage plastics parts and seep inside your vehicle, make sure you do the following when using such equipment:
  - Keep the washing nozzle at least 28 inches (70 cm) away from the vehicle body.

9

### ⚠ CAUTION

- When washing around the door glass, hold the nozzle at a distance of more than 28 inches (70 cm) and at a right angle to the glass surface.
- Make sure to do the following when using an automatic car wash, with help from either this manual or the car wash operator, to avoid damaging your vehicle:
  - Fold the outside rearview mirrors.
  - Tape wiper arm assembly.
  - If your vehicle is equipped with roof rails or roof spoiler, check with the car wash operator before using the car wash.
  - If your vehicle is equipped with the rain sensor, place the wiper switch lever in the "OFF" position to deactivate the rain sensor.
  - Make sure that the charging lid and the fuel lid are completely closed.

### During cold weather

Salt and other chemicals used on winter roads in some geographical areas can have a detrimental effect on the vehicle underbody. You should flush the underbody with a high pressure hose every time you wash the outside of your vehicle.

Take special care to remove mud or other debris which could trap and hold salt and moisture.

After washing your vehicle, wipe off all waterdrops from the rubber parts around the doors to prevent the doors from freezing.

### 📖 NOTE

- When the door is frozen, opening it by force may tear off or crack the rubber gasket installed around the door. Pour warm water to melt the ice. Be sure to thoroughly wipe off the water after opening the door. To prevent freezing of the weatherstripping on the doors, hood, etc., treat with silicone lubricant.

### Waxing

N00946000205

Wax your vehicle once or twice a year, or when water does not bead up on the paint. Use a soft cloth to put a small amount of wax on the painted surfaces. After the wax has dried, polish with a dry soft cloth. Do not wax your vehicle in direct sunlight. You should wax when the painted surfaces are cool.

**CAUTION**

- Waxes containing high abrasive compounds should not be used. These waxes remove rust and stain effectively from the paintwork, but are harmful to the finish of the paint, because they also remove paint/clearcoat.

They are also harmful to other glossy surfaces such as the grille, trim, moldings, etc.

- Do not use gasoline, benzene, kerosene or paint thinners to remove road tar or other dirt from the vehicle surface.
- Do not put wax on the areas having black matte coating because it can cause uneven discoloration, patches, blurs, etc. If these get wax on them, wipe the wax off right away with a soft cloth and warm water.
- On vehicles with sunroof, be careful not to apply any wax on the weatherstrip (black rubber) when waxing the area around the sunroof opening.

If stained with wax, the weatherstrip cannot maintain a weatherproof seal with the sunroof.

**Polishing**

N0094610046

If painted surfaces have been severely damaged and lost their original luster and color tone, polish the surface lightly with a fine polishing compound. Avoid limiting your polishing to the damaged surface only; polish a somewhat wider area, moving the polishing

cloth in one direction. After polishing, flush the compound from the surface and apply a coat of wax to regain a beautiful luster.

**Damaged paint**

N00946201099

Small cracks and scratches in the paint coat should be touched up as soon as possible with touch-up paint to prevent corrosion.

Check body areas facing the road or the tires carefully for damage to the paint caused by flying stones, etc. The paint code number for your vehicle can be found on the vehicle information code plate located on the front passenger door sill.

**Cleaning plastic parts**

N00946301221

Use a sponge or chamois to clean these parts. If the vehicle wax sticks to a gray or black rough surface of the bumper, molding or lights, the surface may appear white in color. In this case, wipe it off using lukewarm water and a soft cloth or chamois.

**CAUTION**

- Do not use a scrubbing brush or other rough scrubber as these may damage the plastic surface.

**Cleaning the outside of your vehicle****CAUTION**

- Do not use wax containing compounds (polishing powder) which may damage the plastic surface.
- Do not let plastic parts get soiled with gasoline, oil, brake fluids, engine oils, greases, paint thinner, and sulfuric acid (battery electrolyte), as such substances will cause stains, cracks, or discoloration.  
If any of these get on a plastic part, wipe them up with a soft cloth or chamois and a mild solution of soap and water. Then rinse them immediately with water.

**Chrome parts**

N00946400052

To prevent spots and corrosion of chrome parts, wash with water, dry thoroughly, and apply a nonabrasive automotive wax. If the chrome is severely damaged or pitted, use a commercially available chrome polish.

**Aluminum wheels**

N00946501223

1. Remove dirt using a wet sponge.
2. Use a mild detergent on any dirt that cannot be removed easily with water.  
Rinse off the detergent after washing the wheels.
3. Dry the wheels thoroughly using a chamois leather or a soft cloth.

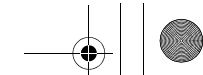

## Cleaning the outside of your vehicle

### CAUTION

- Do not use a brush or other hard implement on the wheels.
- Do not use any cleaner that contains an abrasive substance or is acidic or alkaline. Doing so could cause the coating on the wheels to peel or become discolored or stained.
- Do not directly apply hot water using a steam cleaner or by any other means.
- Contact with seawater or road salt used for de-icing can cause corrosion. Rinse off such substances as soon as possible.

### Cleaning the sunroof (if so equipped)

N00946800069

Clean the inside of the sunroof with a soft cloth. Hard deposits should be wiped away with a cloth dipped in warm, neutral detergent solution. Wipe away the solution with a sponge dipped in fresh water.

### NOTE

- The surface treatment on the inside of the glass may be removed if a hard cloth or organic solvent is used.

## 9 Window glass

N00946600054

The window glass can usually be cleaned using only a sponge and water. Glass cleaner can be used to remove wax, oil, grease, dead insects, etc. After washing the glass, wipe it dry with a clean, dry, soft cloth.

### Engine compartment

N00947001137

Never spray or splash water on the electrical accessories in the engine compartment. This puts the engine at risk of being damaged.

### Wiper blades

N00946700068

Use a soft cloth and glass cleaner to remove grease, dead insects, etc., from the wiper blades.

Replace the wiper blades when they no longer clean the windshield and rear window properly.

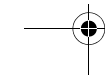
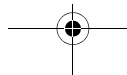

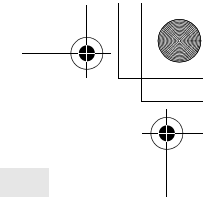
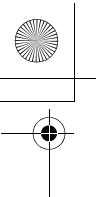

## *Customer assistance/Reporting Safety Defects*

Consumer information (For vehicles sold in U.S.A.) .....	10-2
Reporting Safety Defects .....	10-3
Important facts to know in case of an accident .....	10-4

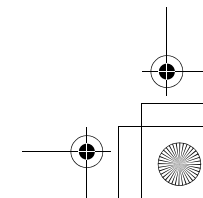
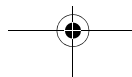
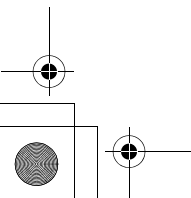
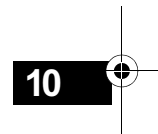
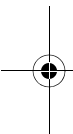



## Consumer information (For vehicles sold in U.S.A.)

### Consumer information (For vehicles sold in U.S.A.)

N01047100171

This information is provided in compliance with the requirements of the National Highway Traffic Safety Administration, Department of Transportation. It provides the purchasers and/or prospective purchasers with information on reporting safety defects.

### Uniform tire quality grading

DOT quality grades - All passenger vehicle tires must conform to Federal Safety Requirements in addition to these grades. The specific grade rating in each grade category is shown on the side wall of the tires on your vehicle.

10

### Treadwear

The treadwear grade is a comparative rating based on the wear rate of the tire when tested under controlled conditions on a specified government test course. For example, a tire graded 150 would wear one and one-half (1½) times as well on the government course as a tire graded 100. The relative performance of tires depends upon the actual conditions of



10-2 Customer assistance/Reporting Safety Defects

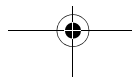

their use, however, and may depart significantly from the norm due to variations in driving habits, service practices and differences in road characteristics and climate.

### Traction AA, A, B, C

The traction grades, from highest to lowest, are AA, A, B and C. Those grades represent the tire's ability to stop on wet pavement as measured under controlled conditions on specified government test surfaces of asphalt and concrete. A tire marked C may have poor traction performance.

#### WARNING

- The traction grade assigned to this tire is based on straight-ahead braking traction tests, and does not include acceleration, cornering, hydroplaning, or peak traction characteristics.

### Temperature A, B, C

The temperature grades are A (the highest), B and C, representing the tire's resistance to the generation of heat and its ability to dissipate heat when tested under controlled conditions on a specified indoor laboratory test wheel. Sustained high temperature can cause the

material of the tire to degenerate and reduce tire life, and excessive temperature can lead to sudden tire failure. The grade C corresponds to a level of performance which all passenger car tires must meet under the Federal Motor Vehicle Safety Standard No. 109. Grades B and A represent higher levels of performance on the laboratory test wheel than the minimum required by law.

#### WARNING

- The temperature grade for this tire is established for a tire that is properly inflated and not overloaded. Excessive speed, underinflation, or excessive loading, either separately or in combination, can cause heat buildup and possible tire failure.

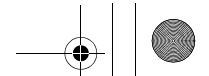

## Reporting Safety Defects

N01047201674

If you believe that your vehicle has a defect which could cause a crash or could cause injury or death, you should immediately inform the National Highway Traffic Safety Administration (NHTSA) in addition to notifying Mitsubishi Motors Corporation.

If NHTSA receives similar complaints, it may open an investigation, and if it finds that a safety defect exists in a group of vehicles, it may order a recall and remedy campaign. However, NHTSA cannot become involved in individual problems between you, your dealer, or Mitsubishi Motors Corporation.

To contact NHTSA, you may call the Vehicle Safety Hotline toll-free at 1-888-327-4236 (TTY: 1-800-424-9153); go to

<http://www.safercar.gov>; or write to:

**NHTSA Headquarters  
1200 New Jersey Avenue, SE  
West Building  
Washington, DC 20590**

You can also obtain other information about motor vehicle safety from <http://www.safercar.gov>.

### For vehicles sold in U.S.A.

To contact Mitsubishi Motors North America, Inc. call 1-888-648-7820 or write to:

**Mitsubishi Motors North America, Inc.  
Customer Relations Department  
P.O. Box 689040  
Franklin, TN 37068**

### For vehicles sold in Canada

If you live in Canada, and you believe that your vehicle has a safety defect, you should immediately notify Transport Canada.

To contact Transport Canada's Defect Investigations and Recalls Division, you may call the toll-free number: 1-800-333-0510.

You may write to:

**Transport Canada-ASFAD  
330 Sparks Street  
Ottawa, ON  
K1A 0N5**

You can also obtain additional information concerning motor vehicle safety from  
<http://www.tc.gc.ca/recalls> (English)  
or  
<http://www.tc.gc.ca/rappels> (French).

### Important facts to know in case of an accident

In addition to notifying Mitsubishi Motor Sales of Canada, Inc.

To contact Mitsubishi Motor Sales of Canada, Inc. call 1-888-576-4878 or write to:

**Mitsubishi Motor Sales of Canada, Inc.**  
**Customer Relations Department**  
**P.O. Box 41009**  
**4141 Dixie Road**  
**Mississauga, ON L4W 5C9**

## 10 For vehicles sold in Puerto Rico

To contact Mitsubishi Motor Sales of Caribbean, Inc. call 1-787-251-8715 or write to:

**Mitsubishi Motor Sales of Caribbean, Inc.**  
**Customer Service Department**  
**P.O. Box 192216**  
**SAN JUAN PR 00919-2216**

### Important facts to know in case of an accident

N01047301327

We hope you will never be involved in an accident, but there is always that potential danger. So, please be sure to buckle up and drive safely.

### In the event of an accident

- Remain calm.
- Check for injuries. Report all injuries to the police, and, if necessary, call for an ambulance.
- Record all the details of the accident. This will provide you with accurate records of the accident for discussions with your insurance company and other persons who may be acting on your behalf.

### Key information to discuss with your insurance company

- Understand your repair estimate before approving repairs.
- Choosing the repair shop and the brands of parts that they use on your vehicle is your decision.

- Ask for genuine Mitsubishi Motors parts. Many times, to save money, your insurance company will recommend imitation parts that do not meet the original specifications of fit, finish, corrosion resistance or workmanship.

### Mitsubishi Motors built-in protection

The strength and integrity built into your vehicle is the result of a specific design referred to as “Energy Management”. Individual body parts are designed to act as one unit in the event of an accident. Shock waves are absorbed by protective panels or are channeled around the passenger compartment. This important feature is possible because high tensile steel is used in the panels and structural parts, something that cannot be guaranteed by the manufacturers of imitation parts. All genuine body panels and support brackets are designed and constructed as important protection features in the event of an accident. By replacing body parts with imitations, your vehicle may no longer meet original equipment specifications.



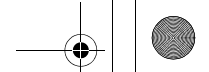

Important facts to know in case of an accident

**Consumer rights (For vehicles sold in U.S.A.)**

Remember to ask for genuine Mitsubishi Motors parts.

As a consumer requesting repair on your vehicle, you have consumer rights. Across the country, State Insurance Commissioners have begun considering rules on the use of non-OEM parts. This could mean that repair shops will have to disclose to the consumer, when they intend to use non-OEM parts. Since regulations are not consistent on this point, remember you have a choice. So, if you want genuine Mitsubishi Motors parts, you may have to specifically request them. Make certain your insurance company understands imitations are not to be used in the repair of your vehicle. You deserve the best genuine Mitsubishi Motors parts.

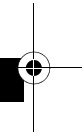
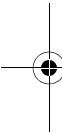

**Genuine Mitsubishi Motors parts**

Genuine Mitsubishi Motors parts are built with the high quality and durability standards you expect. Genuine Mitsubishi Motors replacements parts are your guarantee that your vehicle will have all the technological advantages and maintain the style and protection of a brand new Mitsubishi Motors.

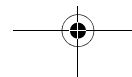



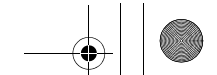

## *Specifications*

Vehicle labeling .....	11-2
Vehicle dimensions .....	11-4
Vehicle weights .....	11-5
Engine specifications .....	11-6
Charging system specifications .....	11-7
Electric motor specifications .....	11-8
12 V starter battery .....	11-8
Tires and wheels .....	11-8
Capacity .....	11-9

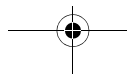

## Vehicle labeling

### Vehicle labeling

N01147401912

Keep a record of the chassis number and vehicle identification number. Such information will assist police if your vehicle is stolen.

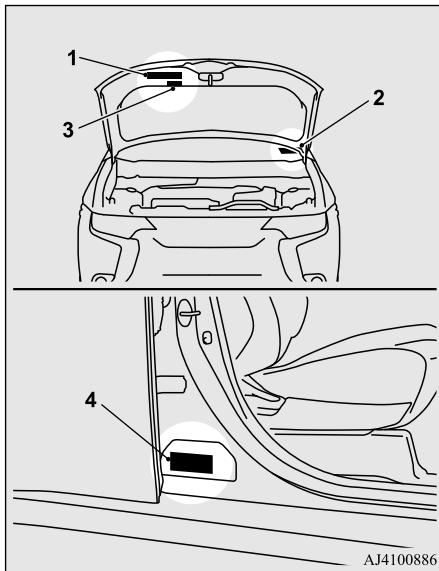

11

#### 1 - Vehicle emission control information label

The vehicle emission control information label is affixed on the underside of the engine hood.

#### 11-2 Specifications

#### 2 - Vehicle identification number plate

The vehicle identification number is stamped on the plate riveted to the left front corner of the dashboard. It is visible from outside of the vehicle through the windshield.

#### 3 - Air conditioning label

The air conditioning label is affixed on the inside panel of the engine hood.

#### 4 - Vehicle information code plate

The vehicle information code plate is located on the front passenger door sill.

### Chassis number

The chassis number is stamped on the bulkhead as shown in the illustration.

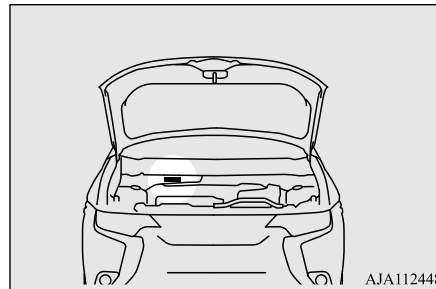

### Engine model/serial number

N01148600028

The engine model and serial number are stamped on the cylinder block as shown in the illustration.

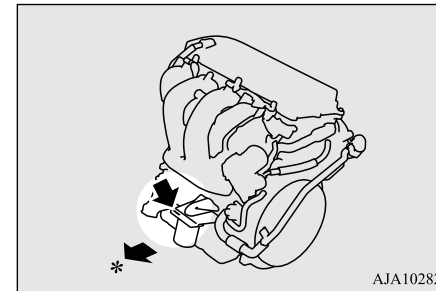

\*: Front of the vehicle

### Electric motor number

N01148700032

The electric motor number is stamped as shown in the illustration.

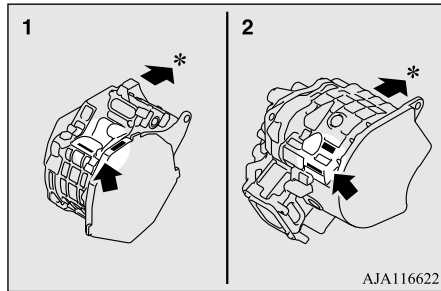

AJA116622

- 1- Front motor
- 2- Rear motor
- \*: Front of the vehicle

### Tire and loading information placard

N01148101671

The tire and loading information placard is located on the driver's door sill.

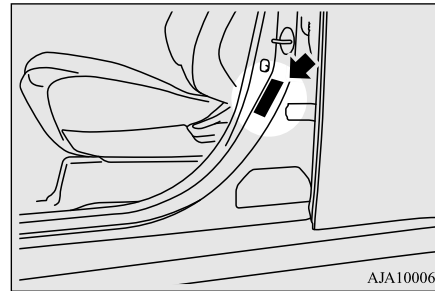

AJA100063

### Type 1

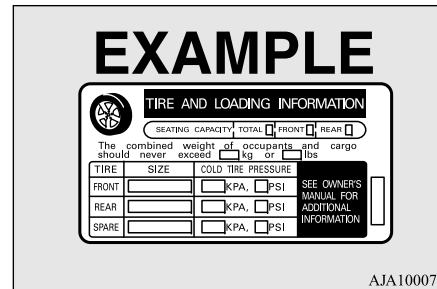

AJA100076

### Type 2

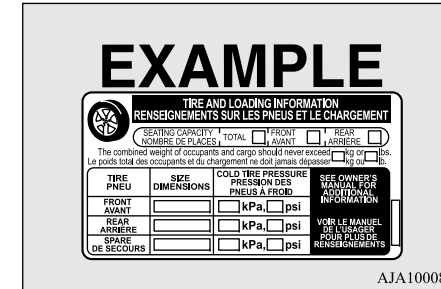

AJA100089

### Certification label

N01148201249

The certification label is located on the driver's door sill.

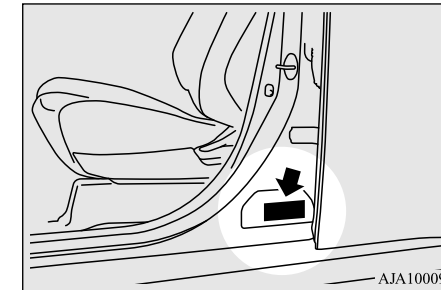

AJA100092

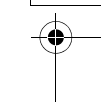
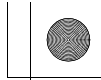
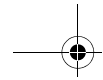
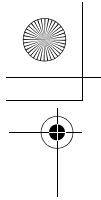

### Vehicle dimensions

## Vehicle dimensions

N01147501636

Overall length	184.8 in (4,695 mm)
Overall width	70.9 in (1,800 mm)
Overall height	67.3 in (1,710 mm)
Wheel base	105.1 in (2,670 mm)

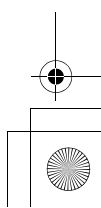
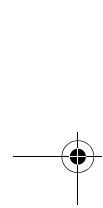
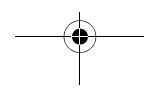
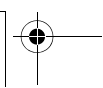
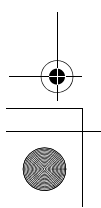
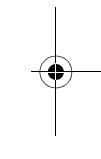

## Vehicle weights

## Vehicle weights

N01147602126

Gross vehicle weight rating (GVWR)		5,269 lb (2,390 kg)
Gross axle weight rating (GAWR)	Front	2,646 lb (1,200 kg)
	Rear	2,800 lb (1,270 kg)
Total trailer weight	With brake	1,500 lb (680 kg)
	Without brake	1,250 lb (567 kg)
Vehicle capacity weight		827 lb (375 kg)
Maximum roof load		110 lb (50 kg)
Seating capacity		5 persons

 **NOTE**

- Roof load is important because it affects the vehicle capacity weight. Refer to “Loading cargo on the roof” on page 6-11.

11

GVWR: maximum total weight (load) limit specified for the vehicle  
 GAWR: maximum weight (load) limit specified for the front or rear axle  
 Seating capacity: the maximum number of occupants



## Engine specifications

### Engine specifications

N01147701641

Engine model	4B12	
Engine displacement	144.0 CID (2,360 cm <sup>3</sup> )	
No. of cylinders and cylinder arrangement	Inline-4	
Bore	3.46 in (88.0 mm)	
Stroke	3.82 in (97.0 mm)	
Compression ratio	12.0	
Thermostat valve opening temperature	188.6 °F (87.0 °C)	
Spark plugs	NGK	DIFR5E11
Spark plug gap	.040 to .043 in (1.0 to 1.1 mm)	
Firing order	1-3-4-2	



11



## 11-6 Specifications

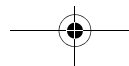



Charging system specifications

**Charging system specifications**

N01148501053

Normal charging system	Rated input voltage	AC 240V (single phase)	AC 120V (single phase)
	Rated input frequency	50 Hz/60 Hz	
	Rated current	15 A (max)	8 A/12 A (max)* <sup>1</sup>
	Maximum power consumption	3.3 kVA* <sup>2</sup>	1.8 kVA* <sup>2</sup>
	Applicable standards	UL2594: Electric Vehicle Supply Equipment SAE J1772: (R) SAE Electric Vehicle and Plug in Hybrid Electric Vehicle Conductive Charge Coupler CSA C22.2 #280 Issued:2013/02/22 Electric Vehicle Supply Equipment	
	Leakage current sensitivity in cable control box	20 mA	
	Enclosure type	Charge connector: Type 3s Control box (CCID): Type 3	
Quick charging system	Applicable standards	CHAdeMO	
	Maximum input current	60 A	
	Enclosure type	Charge connector: Type 3s	

11

\*<sup>1</sup>: When using a genuine charging cable with control box

\*<sup>2</sup>: When using a home or public charging device (EVSE: Electric Vehicles Supply Equipment)

## Electric motor specifications

**Electric motor specifications**

N01147301054

Item	Front motor	Rear motor
Electric motor model	S61	Y61
Maximum output	60 kW	70 kW
Maximum torque	137 N•m	195 N•m

**12 V starter battery**

N01147801323

S46B24L(S)

Battery is a 12 volt type.

**11****Tires and wheels**

N01147901959

Tire	P225/55R18 97H	
Wheel	Size	18 x 7J
	PCD	4.5 in (114.3 mm)
	Offset (Inset)	1.5 in (38 mm)

PCD: Pitch Circle Diameter (installation holes)

**NOTE**

- These tires satisfy vehicle loading conditions described in this owner's manual.

11-8 Specifications

**Capacity**

N0114800246

Item		Capacity	Lubricants
Fuel (approximate)		11.3 gal (43 L)	Refer to “Fuel selection” on page 3-49
Engine oil	Oil pan	4.5 qt (4.3 L)	Engine oils displaying the ILSAC certification mark (“starburst” symbol) on the container. If these oils are not available, an API classification SP oil can be used.
	Oil filter	.32 qt (0.3 L)	
Transaxle	Front	3.66 qt (3.46 L)	Refer to “Transaxle fluid” on page 9-10.
	Rear	.90 qt (0.85 L)	
Brake		As required	Conforming to Brake fluid DOT3 or DOT4
Hood lock release mechanism and safety catch		As required	Multipurpose type grease NLGI Grade 2
Engine coolant {Includes .69 qt (0.65 L) in reserve tank}		7.9 qt (7.5 L)	Mitsubishi Motors Genuine Super Long Life Coolant Premium or equivalent*
Rear motor coolant [includes 1.13 qt (1.07 L) in reserve tank]		6.9 qt (6.5 L)	
Front motor fluid		2.3 qt (2.2 L)	Refer to “Front motor fluid” on page 9-10.
Washer fluid		4.8 qt (4.5 L)	—
Refrigerant (air conditioning)		Refer to the “Air conditioning label” on page 11-2.	HFO-1234yf

\*:similar high quality ethylene glycol based non-silicate, non-amine, non-nitrate and non-borate coolant with long life hybrid organic acid technology



Alphabetical index

**Numerics**

12 V power outlets ..... 5-209  
 12 V starter battery ..... 9-12  
     Specification ..... 11-8  
 12 V starter battery charging system warning light..... 5-188  
 4-wheel drive operation ..... 5-63

**A**

Accessory (installation) ..... 3-55  
 Acoustic vehicle alerting system (AVAS) .... 5-72  
 Active stability control (ASC)..... 5-81  
 Adaptive Cruise Control System (ACC) 5-88  
 Air cleaner filter ..... 9-10  
 Air conditioner  
     Dual-zone automatic climate control air conditioner..... 7-4  
     Important air conditioning operating tips.. 7-14  
 Air purifier ..... 7-15  
 Airbag ..... 4-36  
 All-wheel drive operation ..... 5-63  
 Aluminum wheels ..... 9-43  
 Anti-lock braking system..... 5-78  
 Arm rest..... 4-9

Assist grip ..... 5-228  
 Automatic High Beam (AHB) ..... 5-193  
 Automatic transaxle  
     Select positions ..... 5-58  
     Selector lever operation ..... 5-57

**B**

Back-up light  
     Bulb capacity ..... 9-31  
     Replacement ..... 9-38  
 Ball joint, steering linkage seals, drive shaft boots ..... 9-23  
 Battery  
     12 V starter battery charging system warning light..... 5-188  
     During cold weather ..... 9-12  
     Specification ..... 11-8  
 Battery charge mode ..... 5-69  
 Battery save mode ..... 5-69  
 Blind Spot Warning (BSW)..... 5-109  
 Bottle holders..... 5-226  
 Brake  
     Fluid ..... 9-11, 11-9  
 Brake assist..... 5-78  
 Braking  
     Anti-lock braking system ..... 5-78  
     Braking ..... 6-5  
     Hose ..... 9-23  
     Pad wear alarm ..... 5-74

Pedal ..... 5-73  
 Pedal free play..... 9-21  
 Power brakes ..... 5-73  
 Service brake..... 5-73  
 Warning lights and buzzer ..... 5-187  
 Break-in recommendations ..... 5-3  
 Bulb location and capacity ..... 9-31

**C**

California Perchlorate Materials  
     Requirements ..... 3-56  
 Capacities ..... 11-9  
 Card holder ..... 5-224  
 Cargo area cover..... 5-227  
 Cargo loads ..... 6-11  
 Cargo room light..... 5-222  
     Bulb capacity ..... 9-33  
 Catalytic converter ..... 9-3  
 Cautions and actions to deal with intense cold 3-13  
 Cautions and actions to deal with intense heat 3-12  
 Cautions on the handling of 4-wheel drive vehicles..... 5-65  
 Certification label ..... 11-3  
 Charging  
     Normal charging ..... 3-20, 3-31  
     Quick charging ..... 3-32

**Alphabetical index**

Charging indicator ..... 5-187  
 Charging troubleshooting guide ..... 3-46  
 Child restraint systems ..... 4-24  
 Child safety locks for rear door ..... 5-28  
 Cleaning  
     Inside of your vehicle ..... 9-40  
     Outside of your vehicle ..... 9-41  
 Coat hook ..... 5-229  
 Cold  
     Cautions and actions to deal with intense cold ..... 3-13  
 Consumer information ..... 10-2  
 Coolant  
     Engine ..... 9-8, 11-9  
     Plug-in Hybrid EV System ..... 9-8  
     Rear motor ..... 11-9  
 Cruise control ..... 5-84  
 Cup holder ..... 5-226

**12**

**D**

Daytime running lights  
     Bulb capacity ..... 9-31  
     Replacement ..... 9-35  
 Defogger (rear window) ..... 5-204  
 Defrosting or defogging (windshield, door windows) ..... 7-9, 7-13  
 Dimensions ..... 11-4  
 Dimmer (high/low beam change) ..... 5-193

12-2

Dinghy towing ..... 6-17  
 Disc brake pads ..... 9-23  
 Dome light (front)/Reading lights ..... 5-220  
     Bulb capacity ..... 9-33  
 Dome light (rear) ..... 5-221  
     Bulb capacity ..... 9-33  
 Doors  
     Lock ..... 5-24  
     Power door locks ..... 5-26  
 Downlight ..... 5-222  
 Driving down a long hill ..... 6-5  
 Driving during cold weather ..... 6-5  
 Driving precaution ..... 6-2  
 Driving, alcohol and drugs ..... 6-2  
 Dual-zone automatic climate control air conditioner ..... 7-4

**E**

ECO mode switch ..... 5-199  
 Electric motor  
     Number ..... 11-3  
     Specifications ..... 11-8  
 Electric parking brake ..... 5-45  
 Electric power steering system (EPS) ..... 5-80  
 Electric rear window defogger switch .. 5-204  
 Electrical parking switch ..... 5-55

Electronic immobilizer (Anti-theft starting system) ..... 5-17  
 Emission-control system maintenance .. 9-21  
 Engine  
     Compartment ..... 9-6  
     Coolant ..... 9-8, 11-9  
     Engine model ..... 11-2  
     Hood ..... 9-4  
     Malfunction indicator light ..... 5-188  
     Oil and oil filter ..... 9-6, 11-9  
     Overheating ..... 8-4  
     Serial number ..... 11-2  
     Specification ..... 11-6  
 Engine hood ..... 9-4  
 EV charging cable ..... 3-28  
 EV cruising range ..... 3-7  
 EV switch ..... 5-66  
 Exhaust system ..... 9-23

**F**

Floor console box ..... 5-224  
 Floor mat ..... 6-2  
 Fluid  
     Brake fluid ..... 9-11, 11-9  
     Engine coolant ..... 9-8, 11-9  
     Engine oil ..... 9-6, 11-9  
     Front motor ..... 9-10, 11-9  
     Plug-in Hybrid EV System coolant ..... 9-8  
     Rear motor coolant ..... 11-9

Alphabetical index

Transaxle ..... 9-10, 11-9  
 Washer fluid..... 9-10, 11-9

Fluid capacities and lubricants ..... 11-9

For persons with electro-medical apparatus  
 such as implantable cardiac pacemaker or  
 implantable cardiovascular defibrillator .....  
 3-10

Forward Collision Mitigation System (FCM)  
 5-100

Free-hand advanced security transmitter  
 (F.A.S.T.-key) ..... 5-4

Front fog lights  
 Bulb capacity ..... 9-31  
 Indicators ..... 5-186  
 Replacement ..... 9-36, 9-37  
 Switch ..... 5-199

Front motor fluid ..... 9-10

Front side-marker lights  
 Bulb capacity ..... 9-31  
 Replacement ..... 9-35

Front turn signal light  
 Bulb capacity ..... 9-31  
 Replacement ..... 9-35

Fuel  
 Filling the fuel tank..... 3-51  
 Fuel economy..... 6-2  
 Fuel hoses ..... 9-22  
 Fuel selection ..... 3-49  
 Tank capacity ..... 11-9

Fuel Pump Shut-off System ..... 8-20

Fuses..... 9-24  
 Fusible links ..... 9-24

**G**

General maintenance ..... 9-22  
 General vehicle data ..... 11-4  
 Genuine parts..... 3-56  
 Glove compartment ..... 5-224  
 Glove compartment light  
 Bulb capacity ..... 9-33

**H**

Hazard warning flasher switch..... 5-198  
 Hazard warning lights ..... 5-186  
 Head restraints ..... 4-9  
 Headlights  
 Bulb capacity ..... 9-31  
 Dimmer..... 5-193  
 Headlight flasher ..... 5-193  
 Replacement ..... 9-33, 9-34  
 Switch..... 5-190

Heat  
 Cautions and actions to deal with intense  
 heat..... 3-12  
 Heated steering wheel switch..... 5-205  
 Heating ..... 7-15  
 High beam indicator ..... 5-186

High-mounted stop light  
 Bulb capacity ..... 9-31

High-Voltage components ..... 3-36

Hill start assist ..... 5-77

HomeLink® Wireless Control System 5-214

Hood lock release mechanism and safety  
 catch..... 9-24

Horn switch..... 5-206

How to use electric device during charging ..  
 3-42

**I**

If the vehicle breaks down ..... 8-2

Important facts to know in case of an accident  
 10-4

Indicators ..... 5-160, 5-186

Information screen display ..... 5-161

Inside rearview mirror ..... 5-49

Inspection and maintenance following rough  
 road operation ..... 5-65

Instrument cluster ..... 5-137

Intense cold  
 Cautions and actions ..... 3-13

Intense heat  
 Cautions and actions ..... 3-12

Interior lights..... 5-220

Alphabetical index

**J**

Jack..... 8-6  
 Storage ..... 8-6  
 Jump-starting the Plug-in Hybrid EV system.  
 8-2

**K**

Keyless entry system..... 5-19  
 Keys..... 5-3

**L**

Labeling ..... 11-2  
 Lane Departure Warning System (LDW) .....  
 5-118  
 License plate light  
 Bulb capacity ..... 9-31  
 Replacement ..... 9-39  
 Liftgate..... 5-28  
 Link System..... 5-206  
 Loading information ..... 6-6  
 Lubricants..... 11-9  
 Luggage floor box ..... 5-225  
 Luggage hooks ..... 5-229

**M**

Main drive lithium-ion battery ..... 3-6  
 12-4

MITSUBISHI Remote Control ..... 3-38  
 Modifications to and racing of your vehicle ..  
 3-54  
 Multi Around Monitor ..... 5-128  
 Multi-information display ..... 5-140

**N**

Normal charging ..... 3-20, 3-31

**O**

Octane number..... 3-50  
 Oil  
 Engine oil..... 11-9  
 Operating sound under charging or Remote  
 Climate Control ..... 3-10  
 Operation under adverse driving conditions ..  
 8-19  
 Outside rearview mirrors..... 5-52  
 Overheating ..... 8-4

**P**

Parking ..... 6-6  
 Parking lights  
 Bulb capacity..... 9-31  
 Replacement..... 9-35  
 Plug-in Hybrid EV System..... 3-2  
 Coolant ..... 9-8

Polishing..... 9-43  
 Power brakes..... 5-73  
 Power liftgate ..... 5-30  
 Power outlet ..... 5-209  
 Power switch..... 5-9  
 Power windows ..... 5-40  
 Precautions during Charging the Main Drive  
 Lithium-ion Battery ..... 3-19  
 Puncture (Tire repair kit) ..... 8-7

**Q**

Quick charging ..... 3-32

**R**

Radiator cap ..... 9-9  
 Radio  
 General information about your radio 7-16  
 Reading lights  
 Bulb capacity ..... 9-33  
 Ready indicator ..... 5-187  
 Rear combination lights  
 Bulb capacity ..... 9-31  
 Replacement ..... 9-37  
 Rear Cross Traffic Alert (RCTA) ..... 5-114  
 Rear side-marker lights  
 Bulb capacity ..... 9-31  
 Rear turn signal light





## Alphabetical index

Storage .....	8-6
Towing .....	8-17
Trailer towing .....	6-13
Transaxle fluid .....	9-10, 11-9
Turn signal light	
Indicators .....	5-186
Lever .....	5-198

## U

USB input terminal .....	5-207
How to connect a USB memory device .....	5-207
How to connect an iPod .....	5-208
USB port (for charging) .....	5-210

## V

Vanity mirror .....	5-208
Vanity mirror lights	
Bulb capacity .....	9-33
Vehicle care precautions .....	9-39
Vehicle dimensions .....	11-4
Vehicle labeling .....	11-2
Vehicle preparation before driving .....	6-3
Vehicle weights .....	11-5
Vents .....	7-2

**12**

12-6

## W

Warning lights .....	5-187
Washer	
Fluid .....	9-10, 11-9
Rear window washer .....	5-203
Switch .....	5-202
Washing .....	9-41
Waxing .....	9-42
Weights .....	11-5
Wheel	
Specification .....	11-8
Wiper	
Rear window wiper .....	5-203
Switch .....	5-200
Wiper blades .....	9-21
Wiper deicer switch .....	5-204

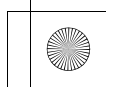
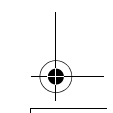
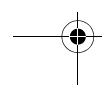
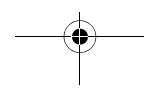
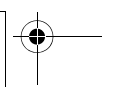
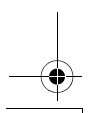
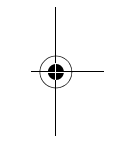
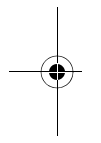
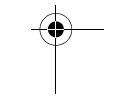
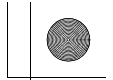
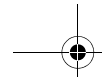
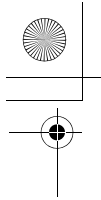

Horizontal dashed lines for text entry





**NOTE**

Name of Owner	Date of Purchase
Address of Owner	Model of Vehicle
Name and Address of Dealer	Vehicle Identification Number

**Maintenance record**

Service Performed	Date	Kilometers Miles	Inspection and Maintenance Item

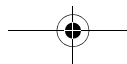

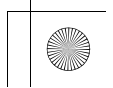
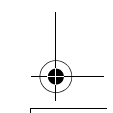
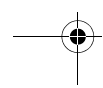
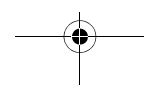
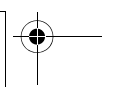
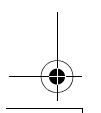
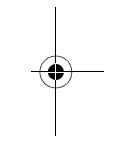
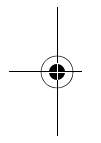
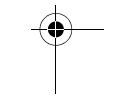
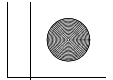
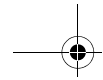
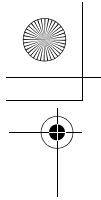

Horizontal dashed lines for text layout