

Introduction

N09200102286

Thank you for buying a MITSUBISHI OUTLANDER SPORT/RVR.

We are confident you will enjoy your vehicle. It has been engineered for optimum performance, durability and comfort. By thoroughly reading this Owner's Manual, you will gain an understanding of the many features that are included in the OUTLANDER SPORT/RVR. The Owner's Manual contains descriptions and illustrations that will assist in the operation and maintenance of your vehicle.

Your Authorized Mitsubishi Motors Dealer will be happy to assist you with any further questions you may have regarding the operation of your vehicle.

Please note that this manual applies to all OUTLANDER SPORT/RVR models and explains all features including options. Some features explained in this manual may not be installed on your vehicle.

Please leave this Owner's Manual in the vehicle at the time of resale. The next owner will appreciate having access to the information contained here.

This manual includes instructions for standard and optional equipment available at the time of printing. Mitsubishi Motors Corporation reserves the right to make changes in design and specifications and to make additions or improvements in its product without assuming any obligation to install these on previously manufactured products.



Throughout this manual the words **WARNING** and **CAUTION** appear. These are reminders to be especially careful. Failure to follow the instructions could result in personal injury or damage to your vehicle.

WARNING

Indicates a strong possibility of severe personal injury or death if instructions are not followed.

CAUTION

Points out hazards or unsafe practices that could cause minor personal injury or damage to your vehicle.

You will see another important symbol:

NOTE

Gives helpful information.

As with other vehicles of this type, failure to operate this vehicle correctly may result in loss of control or an accident. Be sure to read "on-pavement" and "off-road" driving guidelines in the "Driving safety" and "Features and controls" sections.

WARNING

- Engine exhaust, some of its constituents, and certain vehicle components contain or emit chemicals known to the State of California to cause cancer and birth defects and reproductive harm. In addition, certain fluids contained in vehicles and certain products of component wear contain or emit chemicals known to the State of California to cause cancer and birth defects or other reproductive harm.

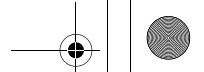

N09348201058

NOTE

Name of Owner	Date of Purchase
Address of Owner	Model of Vehicle
Name and Address of Dealer	Vehicle Identification Number

Maintenance record

Service Performed	Date	Kilometers Miles	Inspection and Maintenance Item

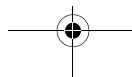
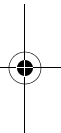
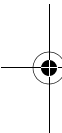

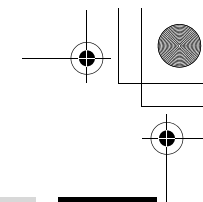
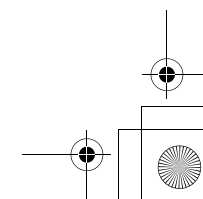
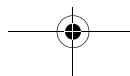
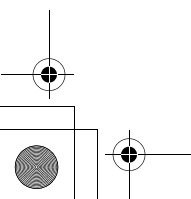
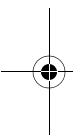

Table of contents

Overview	1
Quick index	2
General information	3
Seat and restraint systems	4
Features and controls	5
Driving safety	6
Comfort controls	7
For emergencies	8
Vehicle care and maintenance	9
Customer assistance/Reporting Safety Defects	10
Specifications	11
Alphabetical index	12



Instruments and controls

1 Instruments and controls

N00100202818

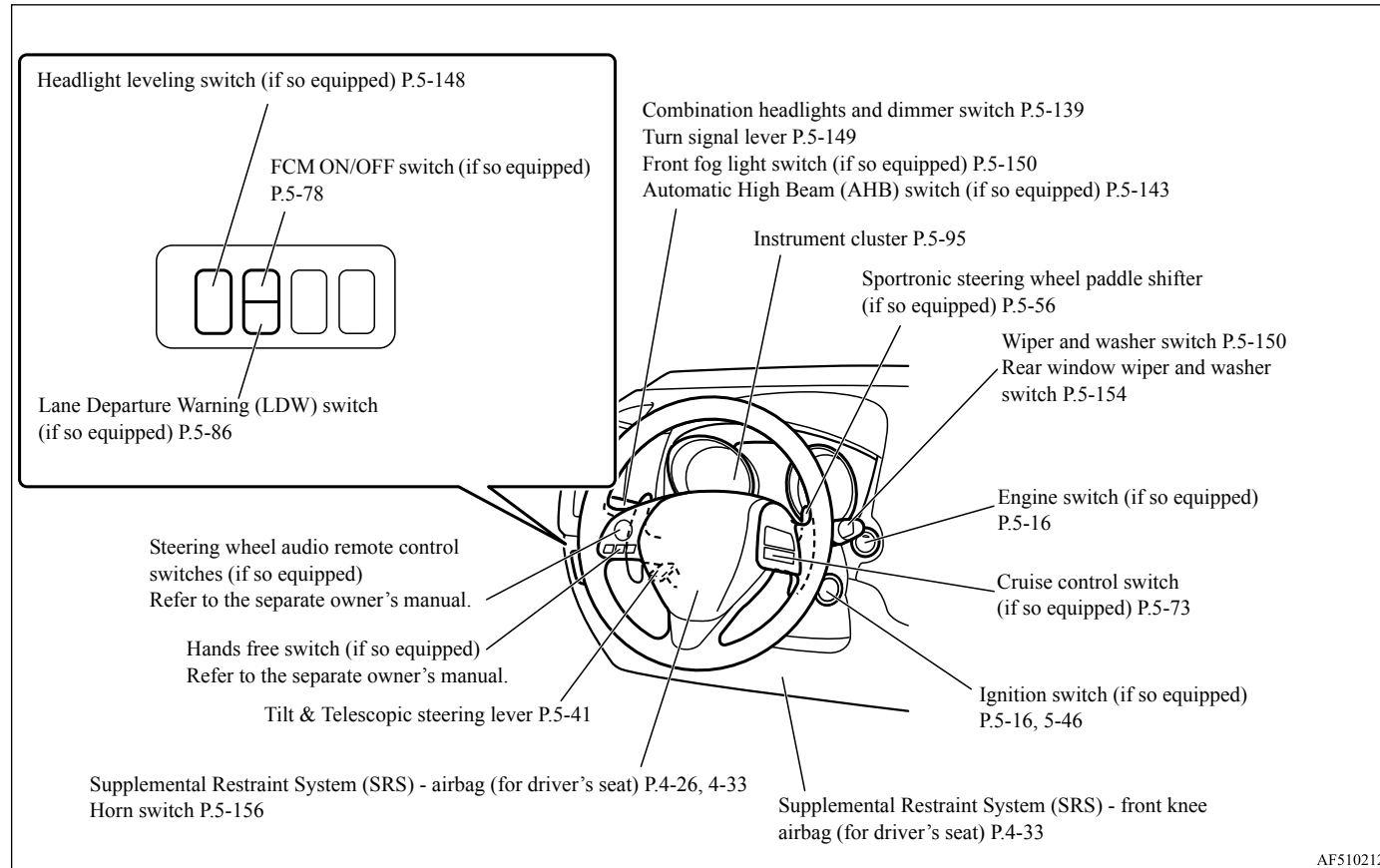

1-1 Overview

Instruments and controls

1

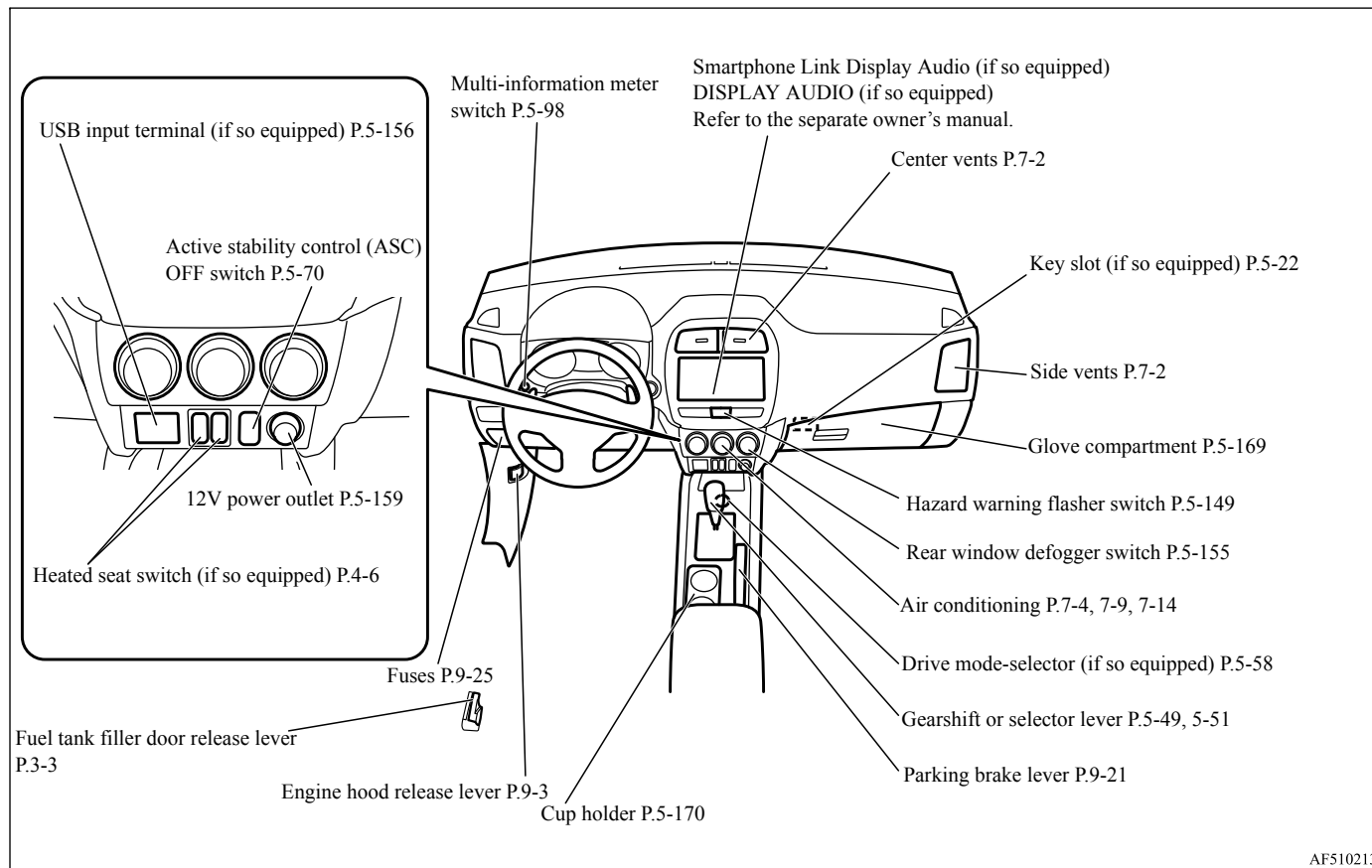

Interior

1 Interior

N00100302503

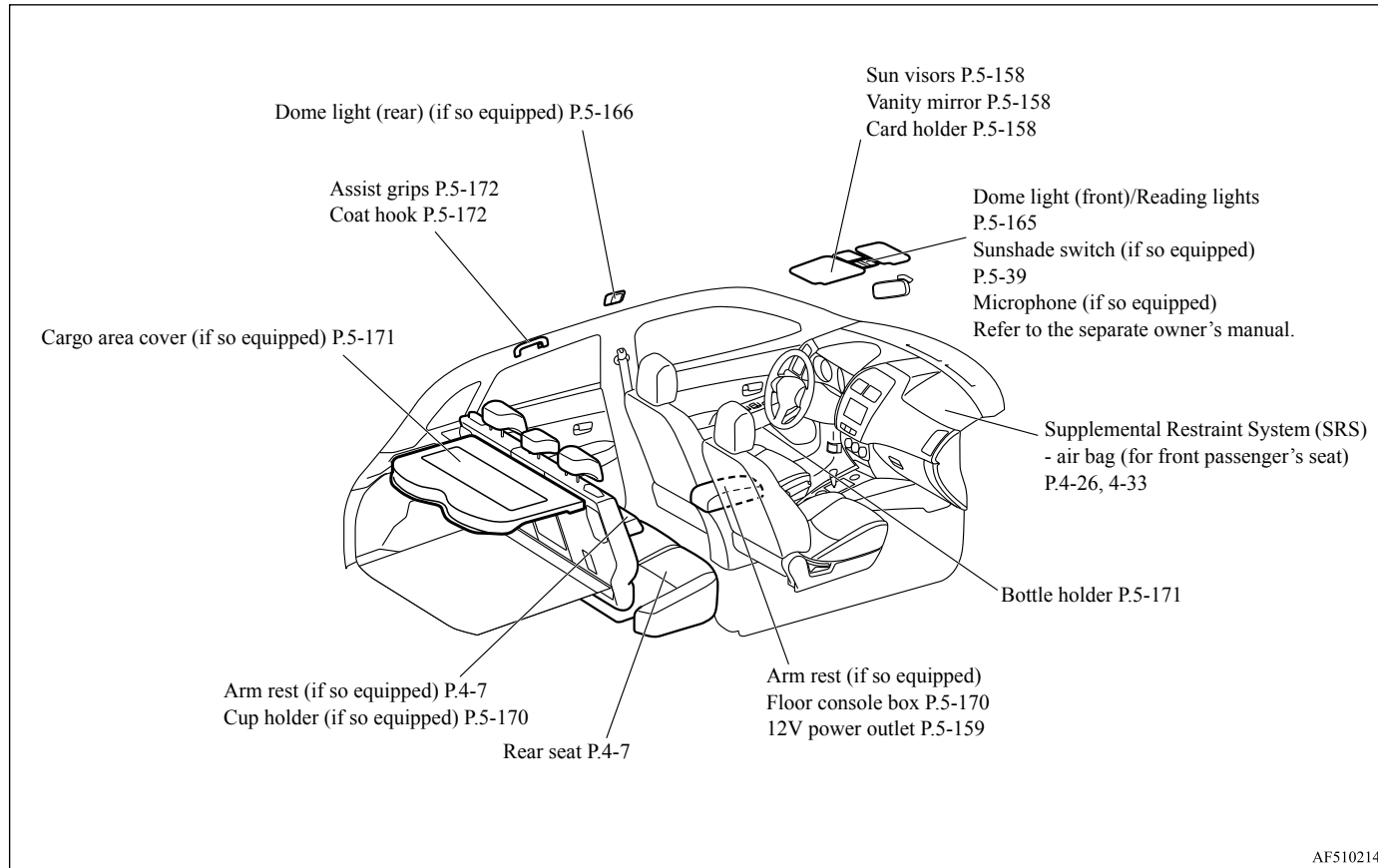

AF5102146

1-3 Overview

Interior

1

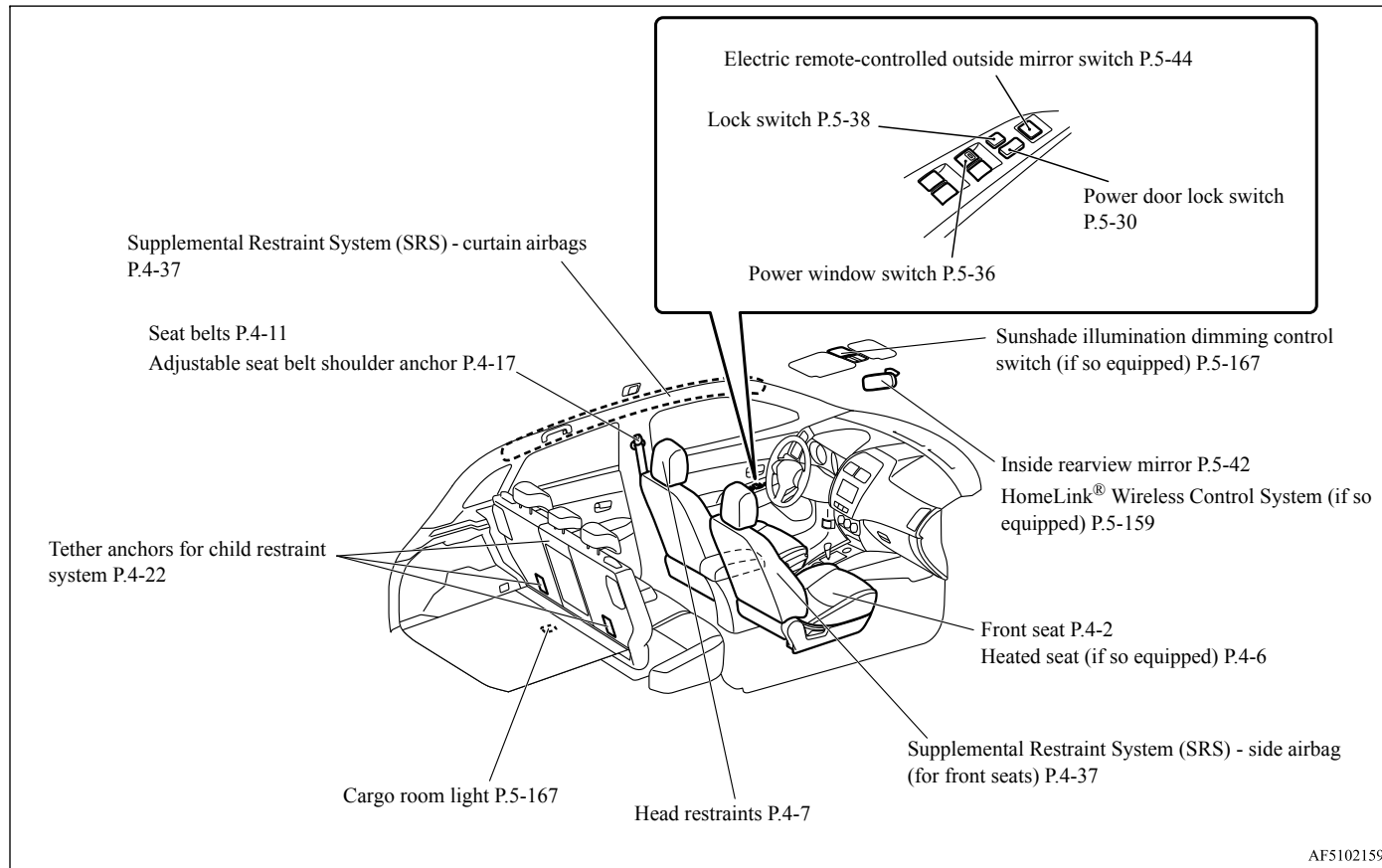

AF5102159

Luggage compartment

1 Luggage compartment

N00100501595

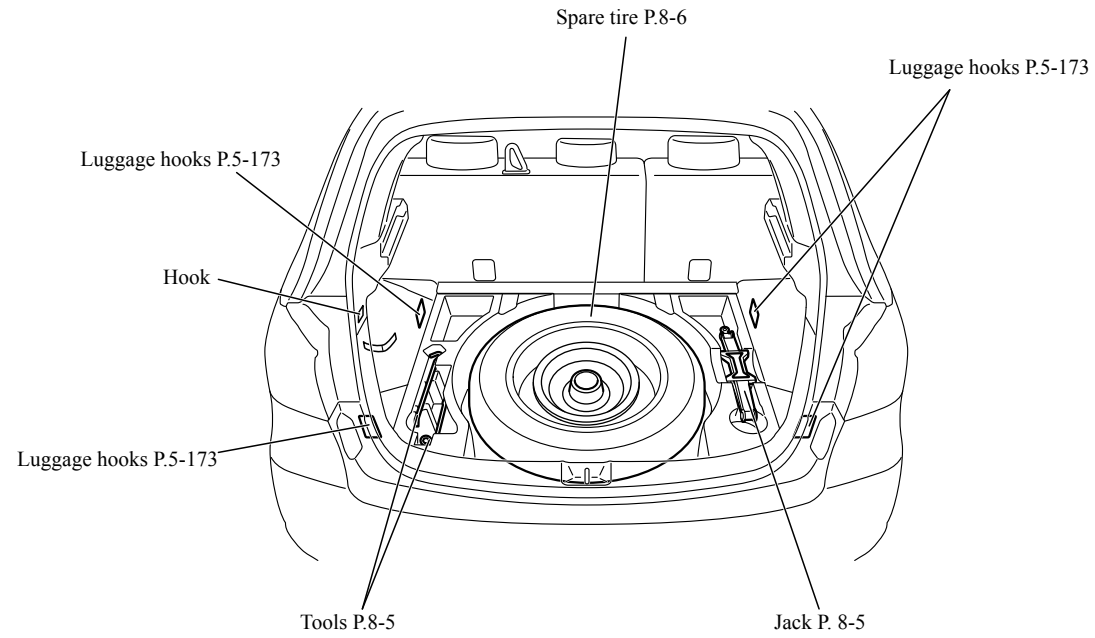

AF5102162

1-5 Overview

Outside

1

N00100602779

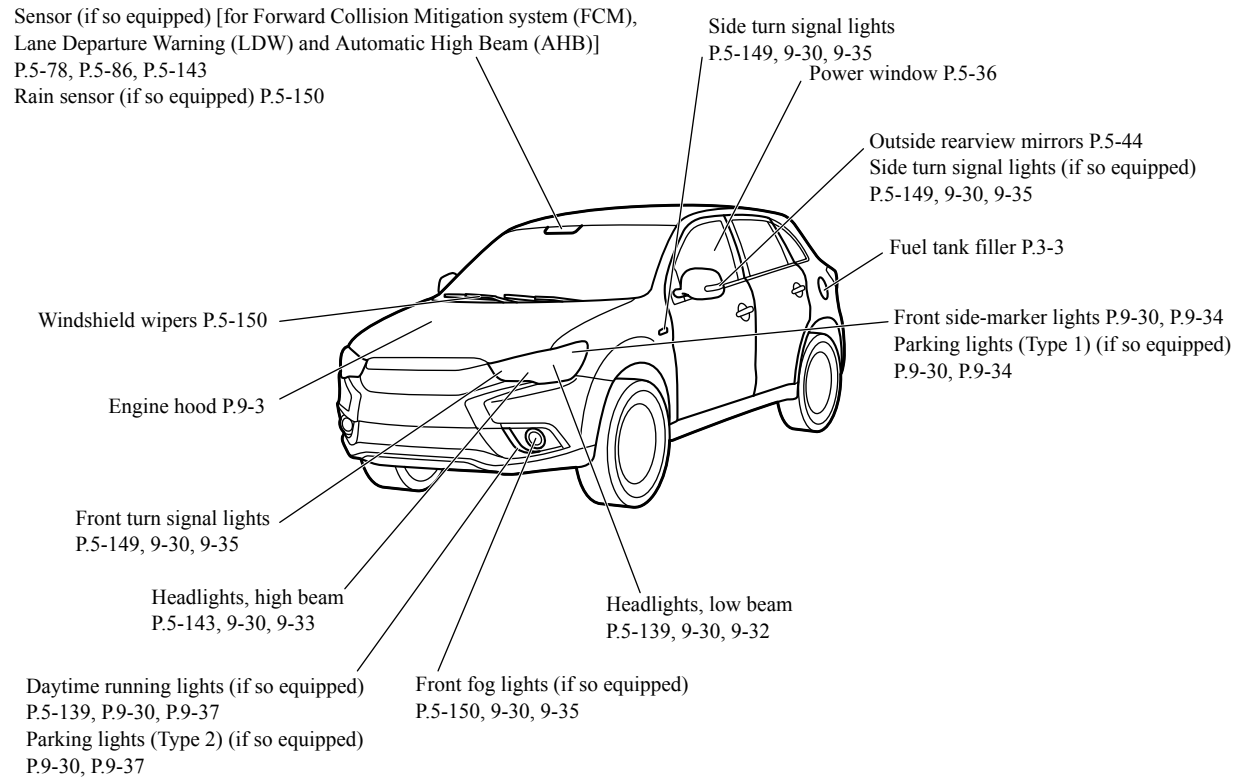

AF5102175

Outside

1

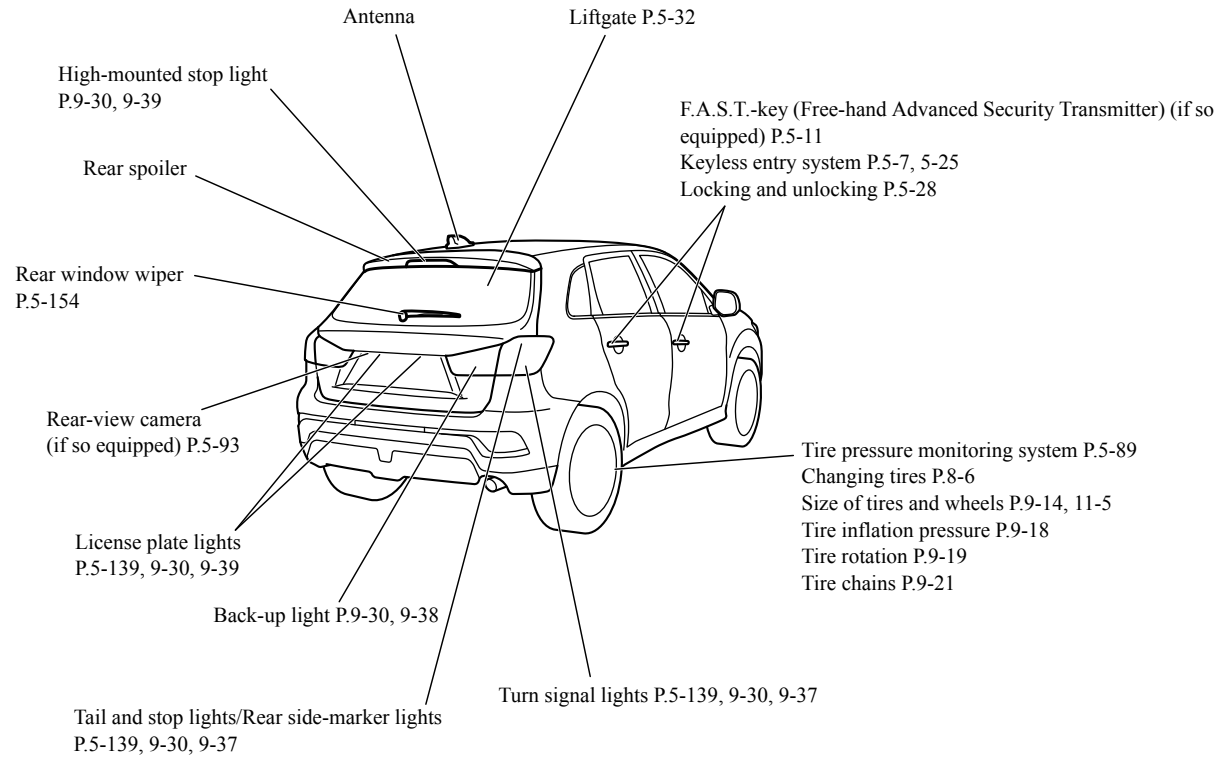

AF5102188

If this warning light comes on or flashes while you're driving...



If this warning light comes on or flashes while you're driving...

N00200702175

2

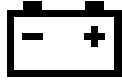

NOTE

- For information regarding warning displays in the multi-information display, refer to “Multi-information display” on page 5-97.
- These warning lights will come on for a few seconds for a bulb check when the ignition switch is first turned to “ON” or the operation mode is put in ON.

Warning lights	Do this	Ref. Page
 Charging system warning light	<ul style="list-style-type: none"> ● Park your vehicle in a safe place and stop the engine. Contact your Mitsubishi Motors dealer or a repair facility of your choice for assistance. 	P. 5-137
BRAKE or  Brake warning light	<ul style="list-style-type: none"> ● If this light comes on while driving, check to see that the parking brake is fully released. ● If this light stays on after releasing the parking brake, immediately stop and check the brake fluid level. ● If the brake fluid level is correct, there may be a system malfunction. Avoid hard braking and high speed, and contact an authorized Mitsubishi Motors dealer or a repair facility of your choice for assistance. 	P. 5-136
SERVICE ENGINE SOON or  Engine malfunction indicator (“SERVICE ENGINE SOON” or “Check engine light”)	<ul style="list-style-type: none"> ● Although your vehicle will usually be drivable and not need towing, have the engine system checked at an authorized Mitsubishi Motors dealer or a repair facility of your choice as soon as possible. If the vehicle is not drivable, contact emergency roadside assistance at 1-888-648-7820 (for vehicles sold in U.S.A.) or 1-888-576-4878 (for vehicles sold in Canada), an authorized Mitsubishi Motors dealer, or local towing company for assistance. 	P. 5-136

If this warning light comes on or flashes while you're driving...

2

Warning lights	Do this	Ref. Page
 <p>Anti-lock braking system warning light</p>	<ul style="list-style-type: none"> ● When this light comes on, the anti-lock braking system is not functioning and only the ordinary braking system is functioning. ● Park your vehicle in a safe place and stop the engine. Test the system as described on page 5-68. ● If the light does not go out after the test, or if it comes on again, we recommend that you have the system checked at an authorized Mitsubishi Motors dealer or a repair facility of your choice as soon as possible. 	<p>P. 5-68</p>
 <p>SRS warning light</p>	<ul style="list-style-type: none"> ● Immediately have the airbag and the pre-tensioner seat belt system checked at an authorized Mitsubishi Motors dealer. 	<p>P. 4-32</p>
 <p>Tire pressure monitoring system warning light</p>	<ul style="list-style-type: none"> ● If the warning light comes on, you should stop and adjust the tires to the proper inflation pressure as soon as possible. (See "Tire inflation pressures" on page 9-18.) Once adjustments have been made, the warning light will go off after a few minutes of driving. ● If the warning light blinks for approximately 1 minute and then remains continuously illuminated, the system is not operating properly. If the system returns to normal, the warning light will go off. If the warning light does not go off, have the vehicle inspected at an authorized Mitsubishi Motors dealer. 	<p>P. 5-89</p>

If this problem occurs...

If this problem occurs...

N00200902021

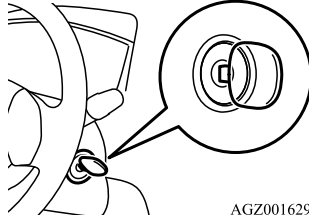
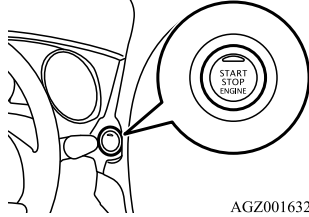

2

Problem	Do this	Ref. Page
<p>Cannot turn the key. (except for vehicles equipped with the F.A.S.T.-key)</p>  <p>AGZ001629</p>	<p>Will not turn from “ACC” to “OFF”. Vehicles with continuously variable transmission (CVT): Check the position of the selector lever. The key cannot be removed unless the selector lever is set to the “P” (PARK) position.</p>	<p>P. 5-47</p>
<p>The engine does not start when the engine switch is pressed. (for vehicles equipped with the F.A.S.T.-key)</p>  <p>AGZ001632</p>	<p>Make sure the F.A.S.T.-key is in the vehicle. Vehicles with manual transaxle: Press and hold the clutch pedal all the way down, and then press the engine switch while depressing the brake pedal. Vehicles with continuously variable transmission (CVT): Make sure the selector lever is in the “P” (PARK) position, and then press the engine switch while depressing the brake pedal.</p>	<p>P. 5-20</p>
<p>The F.A.S.T.-key does not operate. (for vehicles equipped with the F.A.S.T.-key)</p>	<p>Use the emergency key to lock and unlock the door. Insert the F.A.S.T.-key into the key slot inside the glove compartment, and then start the engine or change the operation mode.</p>	<p>P. 5-22</p>



Quick index 2-3

If this problem occurs...

2

Problem	Do this	Ref. Page
<p>Cannot shift the selector lever from the “P” (PARK) position. (for vehicles with continuously variable transmission (CVT))</p>	<p>Shift the selector lever while pressing the brake pedal. Check that the ignition switch or the operation mode is in ON.</p>	<p>P. 5-51</p>
<p>The windows are fogged up.</p> 	<ol style="list-style-type: none"> 1. Set the mode selection dial to the “” or “” position. 2. Turn on the blower. 	<p>P. 7-8, 7-13, 7-18</p>
<p>The engine does not start. The lights do not come on. The lights are dim. The horn does not honk. The horn sound is weak.</p>	<p>Have the battery checked. Recharge or replace as needed.</p>	<p>P. 8-2, P. 9-11</p>

If this problem occurs...

Problem	Do this	Ref. Page
<p>The engine coolant temperature display “ <p>Type 2</p>  </p>	<p>The engine is overheated. Carefully stop the vehicle in a safe place.</p>	<p>P. 8-4</p>
<p>If your vehicle becomes stuck in sand, mud or snow</p>	<ol style="list-style-type: none"> Slowly press down on the accelerator pedal to get your vehicle moving again. For an all-wheel drive vehicle, set the drive mode-selector to the “4WD AUTO” or “4WD LOCK” position and then slowly press down on the accelerator pedal to get your vehicle moving. If there is nothing to stop your tires from slipping, rock your vehicle back and forth to free it. 	<p>P. 8-14</p>

2



⚠ WARNING

- When trying to rock your vehicle out of a stuck position, make sure that there are no people nearby. The rocking motion may cause the vehicle to suddenly lurch forward or backward, possibly injuring bystanders.
- Avoid revving the engine or spinning the wheels. Prolonged efforts to free a stuck vehicle may result in overheating and transaxle failure. If your vehicle is still stuck after several rocking attempts, call for help.

Quick index 2-5

If this problem occurs...

2

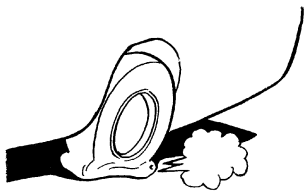
Problem	Do this	Ref. Page
<p>The brakes are not functioning properly after crossing a puddle or stream.</p>	<p>Dry out the brakes by driving slowly while lightly pressing the brake pedal.</p>	<p>P. 5-62, P. 6-5</p>
<p>The continuously variable transmission (CVT) makes no shift change when accelerating. The initial movement of the vehicle is slow when the vehicle starts moving. (for vehicles with CVT)</p>	<p>There may be a problem in the CVT. If the  or  warning lights on the multi-information display will not turn off, or if they come on frequently, please have the vehicle checked at your nearest Mitsubishi Motors dealer.</p>	<p>P. 5-54</p>
<p>A tire is punctured.</p> 	<ol style="list-style-type: none"> 1. Park the vehicle in a safe place where the surface is flat and level. 2. Replace the flat tire with the spare tire. 	<p>P. 8-6</p>

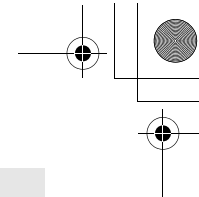

General information

Fuel selection	3-2
Filling the fuel tank	3-3
Modifications to and racing of your vehicle	3-5
Genuine Mitsubishi Motors parts	3-6
California Perchlorate Materials Requirements	3-6

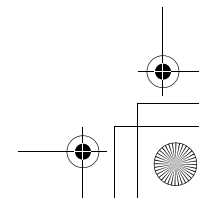
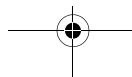
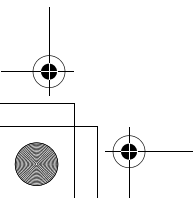
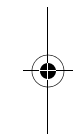
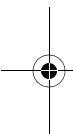

Fuel selection

Fuel selection

N00301001919

3

Your vehicle is designed to use unleaded gasoline only. It is equipped with a fuel tank filler pipe especially designed to accept only a small diameter unleaded gasoline dispensing nozzle.

WARNING

- Gasoline is highly flammable and explosive. You could be burned, seriously injured or killed when handling it. Whenever you refuel your vehicle, stop the engine and keep flames, sparks, and smoking materials away from the vehicle. Always handle fuel in well-ventilated outdoor areas.

CAUTION

- Using leaded gasoline in your vehicle will damage the engine, catalytic converter, and the oxygen sensors. Also, using leaded gasoline is illegal, and will void your warranty coverage of the engine, catalytic converter, and oxygen sensors.

Gasoline detergent additives

In the United States, fuel suppliers are required by law to add detergents to their gas-

3-2 General information

oline to minimize fuel-injector fouling and minimize intake-valve deposits. Detergent gasoline helps keep your engine in tune and your emission-control system working properly.

Octane requirement

Your vehicle is designed to operate on unleaded gasoline having a minimum octane number of 87 [(MON+RON)/2] or 91 RON.

Oxygenated gasoline

Gasoline sold at some service stations contains oxygenates such as ethanol, although the oxygenates may not be identified by those names. Oxygenates are required in some areas of the country. Such fuel can be used in your vehicle.

Ethanol (Gasohol)

A mixture of up to 10% ethanol (grain alcohol) and 90% unleaded gasoline may be used in your vehicle, provided the octane number is at least as high as that recommended for unleaded gasoline.

Methanol

Do not operate your vehicle on gasoline containing methanol (wood alcohol). Using this type of alcohol could adversely affect the vehicle's performance and damage critical parts of the vehicle's fuel system.

Reformulated gasoline

Many areas of the country require the use of cleaner burning fuel referred to as "Reformulated Gasoline".

Reformulated gasoline contains oxygenates and is specially blended to reduce vehicle emissions and improve air quality.

Mitsubishi Motors Corporation strongly supports the use of reformulated gasoline. Properly blended reformulated gasoline has no adverse effect on vehicle performance or the durability of engine and fuel system.

MMT (methylcyclopentadienyl manganese tricarbonyl)

MMT is a manganese-containing metallic additive that is blended into some gasolines to increase the octane number. Mitsubishi Motors Corporation recommends using gasolines without MMT.

Use of gasolines blended with MMT may adversely affect performance, and cause the malfunction indicator on your instrument panel to come on. If this happens, contact an authorized Mitsubishi Motors dealer or a repair facility of your choice for assistance.

Sulfur in gasoline

Your vehicle may have been designed to satisfy California's low-emission regulations based on clean-burning low-sulfur gasoline. Gasoline sold in parts of the country other than California is allowed to have a higher sulfur content. Using such gasoline could adversely affect the vehicle's catalytic converter and cause the engine malfunction indicator ("SERVICE ENGINE SOON" or "Check engine light") to come on. Illumination of this indicator while you are using high-sulfur gasoline does not necessarily mean the vehicle's emission-control system is malfunctioning. Your authorized Mitsubishi Motors dealer may suggest you try using a different, lower-sulfur brand of unleaded gasoline to determine whether the problem is fuel-related.

NOTE

- Poor-quality gasoline can cause problems such as poor starting, stalling during idling, abnormal engine noise, and poor acceleration. If you experience any of these problems, try using a different brand of gasoline. If the engine malfunction indicator ("SERVICE ENGINE SOON" or "Check engine light") flashes, have the vehicle inspected as soon as possible by the nearest authorized Mitsubishi Motors dealer or a repair facility of your choice.
- Repeatedly driving short distances at low speeds can cause deposits to form in the fuel system and engine, resulting in poor starting and poor acceleration. If these problems occur, you are advised to add a detergent additive to the gasoline when you refuel the vehicle. The additive will remove the deposits, thereby returning the engine to a normal condition. Be sure to use a Mitsubishi Motors Genuine cleaning additive. Using an unsuitable additive could make the engine malfunction. For details, please contact the nearest authorized Mitsubishi Motors dealer.

Filling the fuel tank

Filling the fuel tank

N00301101978

WARNING

- **Gasoline is highly flammable and explosive. You could be burned, seriously injured or killed when handling it. When refueling your vehicle, always turn the engine off and keep away from flames, sparks, and smoking materials. Always handle fuel in well-ventilated outdoor areas.**
- **Before removing the fuel tank filler cap, be sure to get rid of your body's static electricity by touching a metal part of the car or fuel pump. Any static electricity on your body could create a spark that ignites fuel vapor.**
- **Perform the whole refueling process (opening the fuel tank filler door, removing the fuel cap, etc.) by yourself; do not let any other person near the fuel tank filler. If you allowed a person to help you and that person was carrying static electricity, fuel vapor could be ignited.**
- **Do not move away from the fuel tank filler until refueling is finished. If you moved away and did something else (for example, sitting on a seat) part-way through the refueling process, you could pick up a fresh charge of static electricity.**
- **Be careful not to inhale fuel vapor. Fuel contains toxic substances.**

3

Filling the fuel tank

3

⚠ WARNING

- Keep the doors and windows closed while refueling the vehicle. If they were open, fuel vapor could get into the cabin.

Fuel tank capacity

All-wheel drive vehicles: 15.8 gal (60 L)
 Front-wheel drive vehicles: 16.6 gal (63 L)

Refueling

1. Before filling with fuel, stop the engine.
2. The fuel tank filler is located on the rear driver side of your vehicle.
 The fuel tank filler door can be opened from inside the vehicle with the fuel tank filler door release lever located at the left side of the driver's seat.

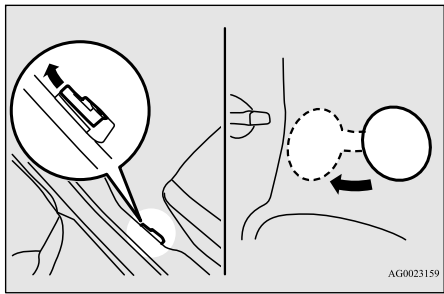

3. Open the fuel tank filler pipe by slowly turning the fuel tank filler cap counter-clockwise.

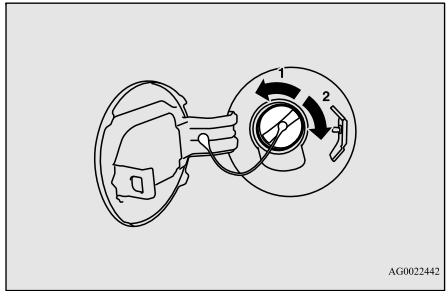

- 1- Remove
- 2- Close

4. While filling with fuel, hang the fuel cap cord on the hook located on the inside of the fuel tank filler door.

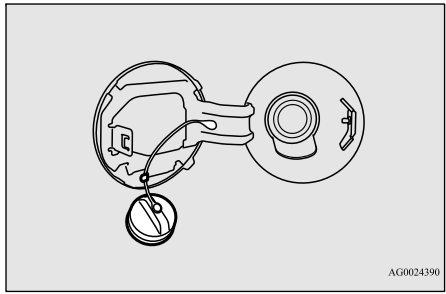

⚠ WARNING

- Since the fuel system may be under pressure, remove the fuel tank filler cap slowly. This relieves any pressure or vacuum that might have built up in the fuel tank. If the cap is venting vapor or if you hear a hissing sound, wait until the sound stops before removing the cap. Otherwise, fuel may spray out, injuring you or others.

5. To fill with fuel correctly depends mainly on correct handling of the fuel filler nozzle. Do not tilt the nozzle. Insert the nozzle in the fuel tank filler port as far as it goes.

⚠ CAUTION

- Your vehicle can only be operated using unleaded gasoline. Serious engine and catalytic converter damage will result if leaded gasoline is filled into these vehicles, and consequently, this must never be attempted.

6. When the nozzle stops automatically, do not try to add more fuel.

⚠ CAUTION

- To avoid fuel spillage and overfilling, do not "top-off" the fuel tank. Spilled fuel could discolor, stain, or crack the vehicle's paintwork. If fuel spills on the paintwork, wipe it off with a soft cloth.

- To close, turn the fuel tank filler pipe cap slowly clockwise until you hear clicking sounds, then gently push the fuel tank filler door closed.

WARNING

- Make sure the fuel tank filler cap is securely closed. If the fuel cap were loose, fuel could leak, resulting in a fire.

CAUTION

- If you need to replace the fuel tank filler cap, use only the cap specified for your model vehicle.

NOTE

- If the fuel tank filler cap is not tight while driving, the engine malfunction indicator (“SERVICE ENGINE SOON” or “Check engine light”) may come on when the onboard diagnostic (OBD) system performs a self check.

Always tighten the fuel tank filler cap until you hear at least 3 clicks.

The indicator will go off after driving several times. If the indicator does not go off, contact your authorized Mitsubishi Motors dealer or a repair facility of your choice as soon as possible.

Modifications to and racing of your vehicle

N00301600149

This vehicle should not be modified with non-Mitsubishi Motors genuine parts. Mitsubishi Motors designs and manufactures high quality vehicles with an emphasis on safety and durability. Modifications using non-Mitsubishi Motors genuine parts may affect the performance, safety and/or durability of your vehicle, and may violate applicable state and/or federal regulations.

DAMAGE OR PERFORMANCE PROBLEMS RESULTING FROM MODIFICATIONS TO OR RACING OF YOUR VEHICLE ARE NOT COVERED UNDER WARRANTY.

Examples of modifications to your vehicle that can cause damage or performance problems include the following:

- Failure to use Mitsubishi Motors genuine parts
- Failure to use required fuel and fluids
- Failure to use proper size tires and wheels
- Modification of the fuel, intake, exhaust, emission, suspension, engine, drive train or electrical wiring systems

Modifications to and racing of your vehicle

- Modification of any onboard computer/control module, including reprogramming, or replacing/adding chips to any onboard computer/control module

Review the Warranty and Maintenance Manual for further details regarding warranty coverage.

Installation of accessories

N00301701222

CAUTION

- Before any electrical or electronic accessories are installed, consult an authorized Mitsubishi Motors dealer.
- Your vehicle is equipped with a diagnosis connector (data link connector) for checking and servicing the electronic control system. Mitsubishi Motors does not recommend connecting a device other than the Scan Tool for inspections and service to this connector because an unexpected problem could result. In addition, malfunctions caused by connecting a device other than the Scan Tool may not be covered under warranty.

- The installation of accessories, optional parts, etc., should only be carried out within the limits prescribed by law, and in accordance with the guidelines and warnings contained within the documents accompanying this vehicle.

General information 3-5

Genuine Mitsubishi Motors parts

3

Only Mitsubishi Motors approved accessories should be fitted to your vehicle.

- Improper installation of electrical parts could cause fire. Refer to the “Modification/alterations to the electrical or fuel systems” section within this owner’s manual.
- Using a cellular phone or radio set inside the vehicle without an external antenna may cause electrical system interference, which could lead to unsafe vehicle operation.
- Tires and wheels which do not meet specifications must not be used.

Refer to the “Specifications” section for information regarding wheel and tire sizes.

WARNING

- **While driving, do not use a cellular phone in a way that hinders safe driving. Anything, including cellular phone usage, that distracts you from the safe operation of your vehicle increases your risk of an accident.**
Refer to and follow all state and local laws in your area regarding cellular phone usage while driving.

Important point!

Due to the large number of accessory and replacement parts provided by different manufacturers in the market, it is not always possible for an authorized Mitsubishi Motors dealer to check whether the attachment or installation of non-Mitsubishi Motors genuine parts affects the driving safety of your Mitsubishi-vehicle.

Modification/alterations to the electrical or fuel systems

N00301800138

Mitsubishi Motors manufactures high quality vehicles with an emphasis on safety. It is important to consult an authorized Mitsubishi Motors dealer before installation of any accessory which may involve modification of the electrical or fuel systems.

CAUTION

- Please consult an authorized Mitsubishi Motors dealer concerning any such accessory fitment or modification.
If the wires interfere with the vehicle body or improper installation methods are used (protective fuses not included, etc.), electronic devices may be adversely affected, resulting in a fire, vehicle damage, or other accident.

Genuine Mitsubishi Motors parts

N00301400219

Mitsubishi Motors Genuine Parts are designed and manufactured to meet high standards of performance, and are recommended for all of your maintenance needs. Also available from your Mitsubishi Motors dealer are a wide variety of accessories to personalize your new vehicle. Each Mitsubishi Motors vehicle has a selection of Mitsubishi Motors authorized accessories to choose from to tailor your new vehicle to your own personal preference. Your Mitsubishi Motors dealer’s Parts Manager has information on various audio systems, protection items, as well as interior and exterior accessories available for your specific model.

California Perchlorate Materials Requirements

N00300100017

Certain components of this vehicle, such as airbag modules, seat belt pretensioners, and button cell batteries, may contain perchlorate materials.
Special handling may apply. For additional information, see www.dtsc.ca.gov/hazardous-waste/perchlorate.

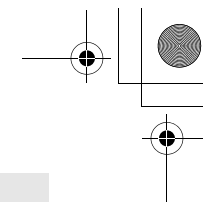

Seat and restraint systems

Seats	4-2
Seats and restraint systems	4-2
Front seats	4-3
Rear seats	4-7
Head restraints	4-7
Extending a luggage compartment	4-9
Seat belts	4-11
Seat belt use during pregnancy	4-17
Seat belt pre-tensioner and force limiter systems	4-17
Child restraint systems	4-19
Maintenance and inspection of seat belts	4-26
Supplemental Restraint System (SRS) - airbag	4-26

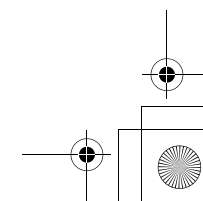
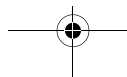
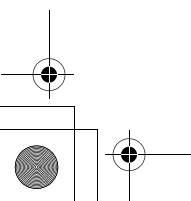
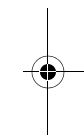
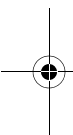

Seats

Seats

N00408401623

4

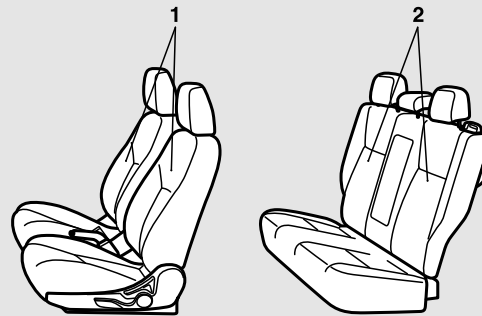

AG1002472

1 - Front seat

- To adjust the seat forward or backward → Page 4-3
- To adjust the seatbacks → Page 4-4
- To adjust the seat height (Driver's seat only) → Page 4-5
- Heated seat (if so equipped) → Page 4-6

2 - Rear seats

- Arm rest (if so equipped) → Page 4-7

Seats and restraint systems

N00401601264

Your vehicle has seat belts and other features that help protect you and your passengers in an accident.

Seat belts are the most important safety device. When worn properly, seat belts can reduce the chance of serious injury or death in various types of crashes. For added protection during a severe frontal collision, your vehicle has a Supplemental Restraint System (SRS) with airbags for the driver and passengers. The seats, head restraints, and door

locks also are safety equipment, which must be used correctly.

Always check the following before you drive:

- That everyone in your vehicle is properly wearing their seat belt.
- That infants and small children are properly secured in appropriate child restraint systems in the rear seat.
- That all doors are fully closed and locked.
- That seatbacks are upright, with head restraints properly adjusted.

Front seats

Safety equipment cannot prevent injury or death in all motor vehicle accidents. You can help reduce the risk of injury or death, however, by following the instructions in this manual.

WARNING

- Do not place objects under the seats. This could prevent the seat from locking securely, and it could lead to an accident. It may also cause damage to the seat or other parts.

Front seats

N00401801468

Position the driver's seat as far back as possible while maintaining a position that still enables you to fully apply the pedals, easily control the steering wheel and safely operate the vehicle.

Manual seat adjustment



Power seat adjustment



AFA110497

WARNING

- Do not attempt to adjust the seat while driving. This can cause loss of vehicle control and result in an accident.
- After adjusting the seat, make sure that it is securely locked into position.
- To reduce the risk to the driver of serious injury or death during deployment of the driver's airbag, always properly wear the seat belt and adjust the driver's seat as far back as possible while maintaining a position that still enables you to fully apply the pedals, easily control the steering wheel, and safely operate the vehicle.
- To reduce the risk to the front passenger of serious injury or death during deployment of the passenger's airbag, always properly wear the seat belt and adjust the front passenger's seat as far back as possible.
- Always place children 12 years old and under in the rear seat and use appropriate child restraint systems.

CAUTION

- Make sure that the seat is adjusted by an adult. If it is adjusted by a child, an unexpected accident might occur.
- Do not place a cushion or the like between your back and the seatback while driving. The effectiveness of the head restraints will be reduced in the event of an accident.

CAUTION

- When sliding the seats, be careful not to catch your hand or leg.
- When sliding or reclining the seat rearward, pay careful attention to the rear seat passengers.

4

To adjust the seat forward or backward

N00401901371

Manual seat adjustment

Pull the seat adjusting lever up and slide the seat forward or backward to the desired position. Release the adjusting lever to lock the seat in place.

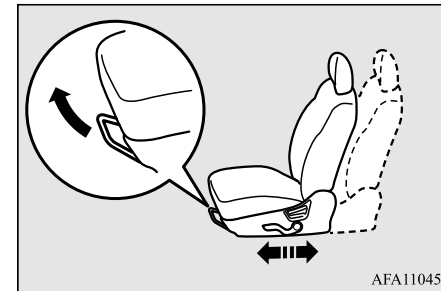

AFA110455

Front seats

⚠ WARNING

- To make sure that the seat is securely locked, try to move it forward or backward without using the adjusting lever.

4

Power seat adjustment

Operate the switch forward or backward to move the seat to the desired position. Release the switch to lock the seat in place.

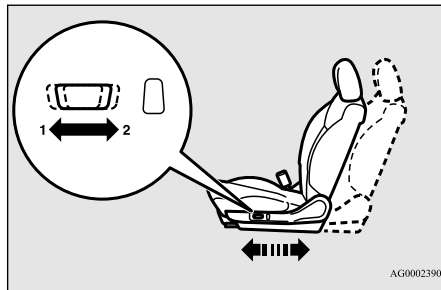

- 1- Forward (toward the front of the vehicle)
- 2- Backward (toward the rear of the vehicle)

NOTE

- To prevent the battery from going dead, operate the power seat with the engine running.

To adjust the seatbacks

N00402001425

Manual seat adjustment

To adjust the seatback, lean forward slightly, gently pull the seatback lock lever up, then lean backward to a comfortable position and release the lever. The seatback will lock in place.

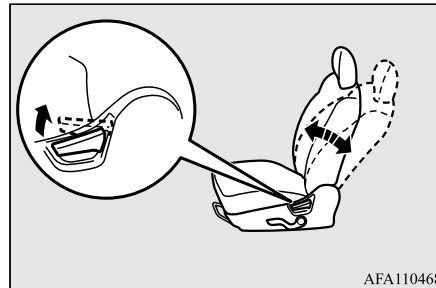

⚠ CAUTION

- The reclining mechanism used in the seatback is spring loaded, and will cause the seatback to return quickly to the vertical position when the lock lever is operated. When pulling the lever, sit close to the seatback or hold the seatback with your hand to control its return motion.

Power seat adjustment

Operate the switch in the direction of the arrows to adjust the seatback.

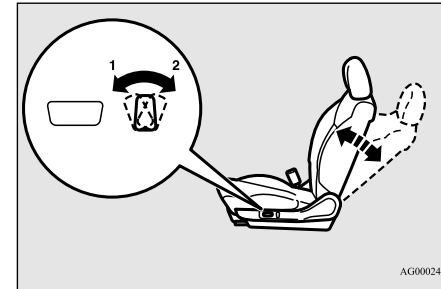

- 1- Move forward
- 2- Move backward

NOTE

- To prevent the battery from going dead, operate the power seat with the engine running.

⚠ WARNING

● To reduce the risk of serious injury or death in the event of an accident or sudden stop, all seatbacks should be kept in the upright position while the vehicle is in motion. Seat belt performance during an accident can be adversely affected if the seatbacks are reclined. The more a seatback is reclined, the more likely seat belt performance will be adversely affected. If the seat belt is not properly positioned against the body during an accident, there is increased risk you will slide under the belt and receive serious injury or death.

To adjust the seat height (Driver's seat only)

N00402101282

Manual seat adjustment

Operate the lever repeatedly to raise or lower the seat.

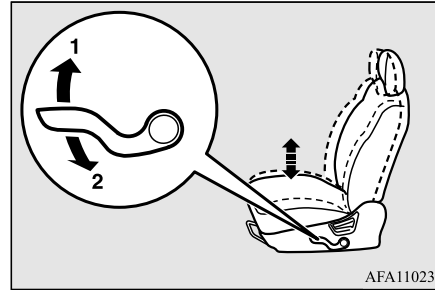

- 1- Raise
- 2- Lower

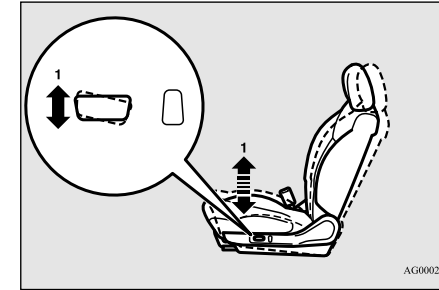

- 1- Raise or lower the front end of the seat

4

Power seat adjustment

Operate the switch in the direction of the arrows to raise or lower the seat.

📖 NOTE

- To prevent the battery from going dead, operate the power seat with the engine running.

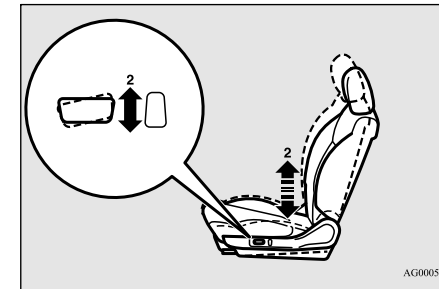

- 2- Raise or lower the back end of the seat

Front seats

4

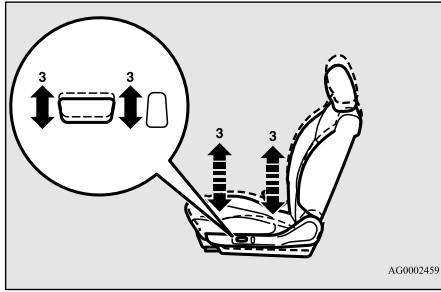

3- Raise or lower the entire seat

Heated seat (if so equipped)

N00435601489

The heated seats can be operated by pushing the switch when the ignition switch or the operation mode is in ON. The indicator light (A) will illuminate while the heater is on.

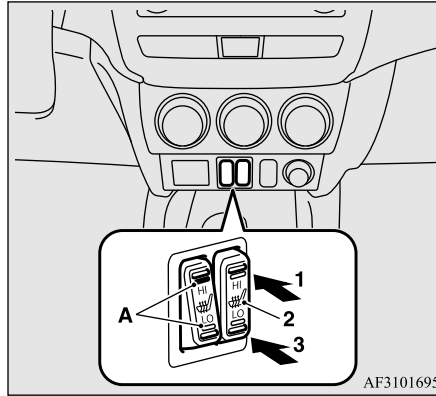

AF3101695

- 1 (HI) - Heater high (for quick heating)
- 2 - Heater off
- 3 (LO) - Heater low (to keep the seat warm)

WARNING

- Persons who are unable to feel temperature change or skin pain due to age, illness, injury, medication, alcohol use, fatigue or other physical conditions or who have sensitive skin may suffer burns when using the heated seat even at low temperatures. To reduce the risk of burns, people with such conditions must use care when using the heated seat.

CAUTION

- Switch off the heated seats when not in use. Operate the heaters at the “HI” position for quick heating. After the seat has become warm, set the heater switch to the “LO” position to keep it warm. Slight variations in the seat temperature may be felt while using the heated seats. This is caused by the operation of the heater’s internal thermostat and does not indicate a malfunction.
- Do not place heavy objects on the seat or stick pins, needles, or other pointed objects into the seat.
- Do not place a blanket, cushion, or other insulating material on the seat while using the heater; doing so can cause the heater element to overheat.
- When cleaning the seat, do not use benzine, kerosene, gasoline, alcohol, or other organic solvents; doing so can cause damage not only to the surface of the seat, but also to the heater.

Rear seats

CAUTION

- If water or any other liquid is spilled on the seat, allow it to dry thoroughly before attempting to use the heater. Turn the heater off immediately if it appears to be malfunctioning during use.

Rear seats

N00402500191

Arm rest (if so equipped)

N00403000308

Tilt the arm rest down for use as shown. The arm rest includes a cup holder. (Refer to “Cup holder: For the rear seat” on page 5-170.)

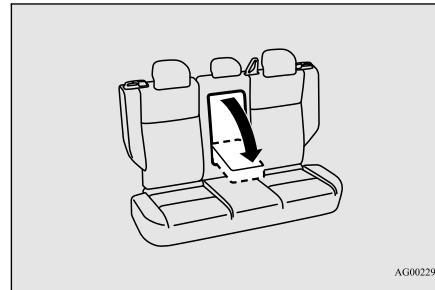

NOTE

- Never sit on the arm rest. Doing so could damage the arm rest.

Head restraints

N00404300542

Padded head restraints for the seats can reduce the risk of a whiplash injury if your vehicle is hit from the rear.

The head restraints are equipped in the illustrated position.

To maximize the effectiveness of your head restraint, adjust the front seatback to the upright position, the rear seatback to the normal seating position, and the head restraint to the proper position. Sit back against the seatback with your head close to the head restraint.

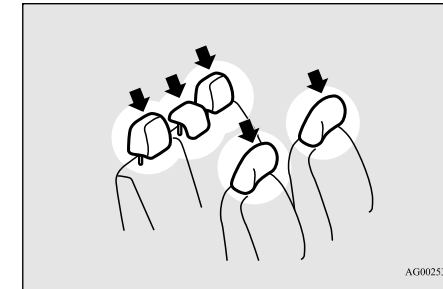

4

Head restraints

4

⚠ WARNING

- **Driving without the head restraints in place can cause you and your passengers serious injury or death in an accident. To reduce the risk of injury in an accident, always make sure the head restraints are installed and properly positioned when the seat is occupied.**
- **In order to minimize the risk of a neck injury due to a rear impact, the front seatback must be adjusted to the upright position, the rear seatback to the normal seating position, and the head restraint to the proper position before vehicle operation. The driver should never adjust the seat while the vehicle is in motion.**
- **Never place a cushion or similar device on the seatback. This can adversely affect head restraint performance by increasing the distance between your head and the restraint.**

Adjustment of the head restraint height

To reduce the risk of injury in an accident, adjust the head restraint height so that the center of the restraint is at your eye level when seated. Any person too tall for the restraint to reach their eye level when seated should raise the restraint to the highest locked position.

4-8 Seat and restraint systems

- To raise the restraint, pull it straight up.
- To lower the restraint, push down on it while pressing the lock knob (A) in the direction shown by the arrow.
- After adjusting the height, push down on the restraint to make sure it is locked in position.

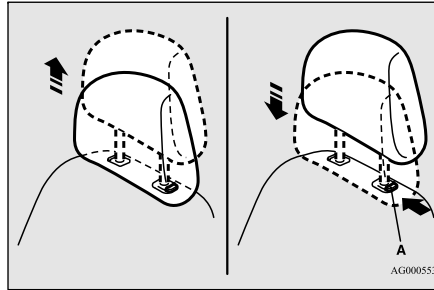

To remove

Press the lock knob (A) in the direction shown by the arrows. Then pull the head restraint up and out of the seatback.

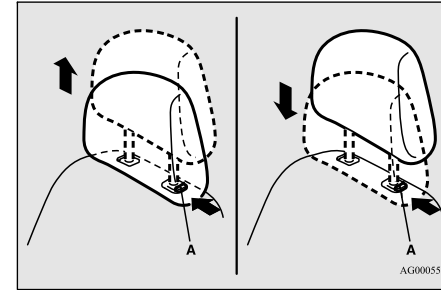

⚠ WARNING

- **To help minimize the risk of neck injury in the event of an accident, the head restraints must be properly installed and positioned to proper height before vehicle operation.**

To install

First check that the head restraint is facing in the right direction as shown in the previous illustration, and then insert it into the seatback. Push the head restraint down while pressing the lock knob (A) until the restraint locks into place.

CAUTION

- Check that the lock knob (A) is extended out as shown in the illustration. Then pull the head restraint up to make sure that it is locked in place and will not come out of the seatback.

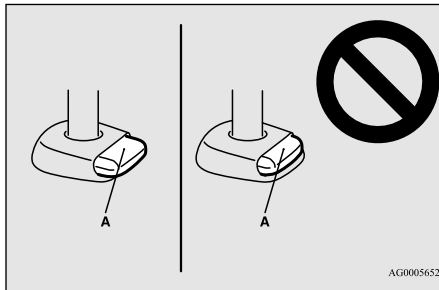

CAUTION

- The shape and size of the head restraint differs according to the seat. Always use the correct head restraint provided for the seat and do not install the head restraint in the wrong direction.

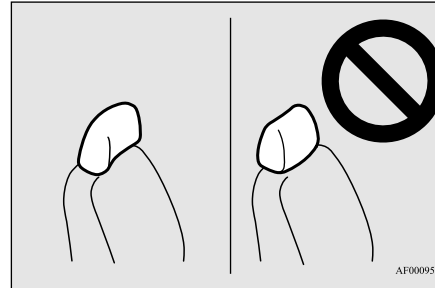

Extending a luggage compartment

N00405500105

WARNING

- Never adjust the seats to extend a luggage compartment while the vehicle is in motion or on a slope. The seats could move suddenly and cause serious injury or an accident.
- After returning a seatback to its normal position, make sure that the seatback is firmly secured. If the seatback is not secured, it could move and cause a serious accident.
- Do not allow anyone to ride in the luggage compartment while the vehicle is in motion. People who are not properly seated and restrained can be seriously injured or killed in an accident.

Extending a luggage compartment

WARNING

- The luggage compartment in the rear of the vehicle should never be used as a play area by children. All children should be properly restrained in a restraint device that offers the maximum protection for their size and age. Refer to “Child restraint systems” on page 4-19.
- The front passenger seat is equipped with weight sensors. Depending on the weight detected, the front passenger airbag is disabled or enabled. When folding the rear seats forward for increased cargo capacity, the front passenger seat and seatback must be adjusted to assure they are not contacting the rear seat. In the event the front seat or seatback is allowed to contact the folded rear seat, proper operation of the front passenger airbag system may be affected.

4

CAUTION

- In the luggage compartment, do not load the luggage higher than the top of the seats and make sure that the luggage is firmly secured. Restricted rear vision or unsecured objects entering the passenger compartment from the luggage compartment during sudden braking can cause serious injury or an accident.
- Seatbacks should always be folded and put back into normal position by an adult. Seat adjustments by a child could lead to an unexpected accident.

Extending a luggage compartment

⚠ CAUTION

- When adjusting the seats, be careful not to catch your hand or leg. Personal injury could result.

4

📖 NOTE

- When the seatback of a front seat is reclined, return it to the upright position before driving.

Folding the rear seatbacks forward

N00417801069

The passenger and luggage compartments can be joined by folding the seatback forward. This is useful for carrying long objects. The seatbacks can be folded with the rear seat release button.

📖 NOTE

- You can separately fold the right and left side of the seatback.

To fold the seatbacks

⚠ CAUTION

- Before folding the driver's side rear seatback, detach the center seat belt from the detachable anchor and retract the center seat belt all the way to the rear trim to prevent damage to the seat belt caused by an object in the luggage compartment. For details, refer to page 4-14.

Push the rear seat release button (A) to fold the seatback forward.

The rear outboard seat belt can be separated from the seat belt guide (B) to help prevent damage to the seat belt while the seatback is folded.

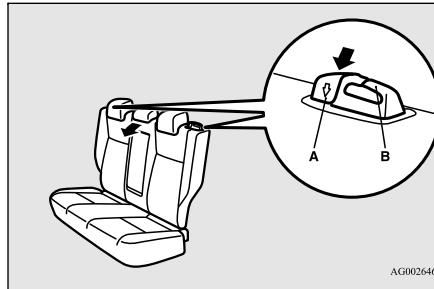

To return the seatbacks

1. If the outboard seat belt has been separated from the seat belt guide (B), insert it back into the seat belt guide.
2. Tilt the seatback up until it is locked properly in position.

⚠ WARNING

- After returning the seatbacks to their upright positions, make sure that the rear seat belts are in front of the seatbacks, and not caught behind the seatbacks.

📖 NOTE

- If the seat belt locks up and cannot be pulled out, pull it once with force and let it retract all the way. Then, pull the belt out slowly once again.

3. Make sure the seatback is locked securely in place and the seat belt is passed through the seat belt guide (B).

⚠ WARNING

- If the red part (C) on the back of the rear seat release button can be seen, the seatback is not locked firmly in place. Push and pull lightly on the seatback to lock it firmly in place.

Seat belts

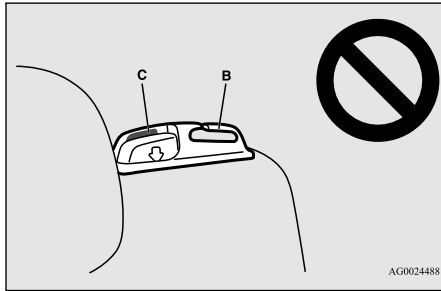

5. After making sure that the seat belt is not twisted, insert the small latch plate (E) into the detachable anchor (F) aligning the marks (G) on the plate and buckle until a “click” is heard. Make sure the detachable anchor is securely latched and seat belt is not twisted. For details, refer to page 4-14.

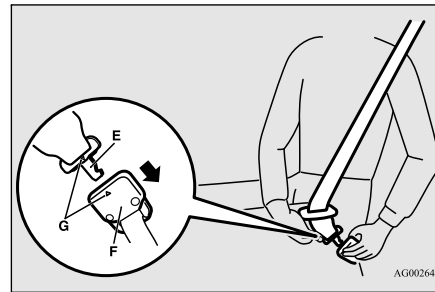

⚠ WARNING

- Using the rear center seat belt with the detachable anchor unlatched increases the risk of serious injury or death in an accident. Make sure the detachable anchor is properly latched.

4. If the center seat belt is stored in the rear trim, pull the seat belt out and pass it through the seat belt guide (D) near the center of the rear seat backs.

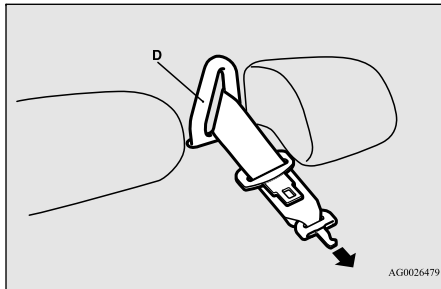

Seat belts

N00406001537

Seat belts are installed in your vehicle to help reduce the risk of injury to the driver and passenger in the event of an accident. Always use the provided seat belts. Carefully review the following information for proper seat belt usage.

4

⚠ WARNING

- To help reduce the risk of injury or death in an accident, seat belts and child restraint systems must always be used. Refer to “Child restraint systems” on page 4-19 for additional information.
- Never use one seat belt for more than one person.
- Never carry more people in your vehicle than there are seat belts.
- Always adjust the seat belt for a snug fit.
- Always place the shoulder belt over your shoulder and across your chest. Never put it behind you or under your arm.
- Always wear the lap belt as low as possible across your hips, not around your waist.

Seat belts

4

WARNING

- Never insert any foreign object, such as a piece of plastic, paper clip, button or coin, into the seat belt buckle.

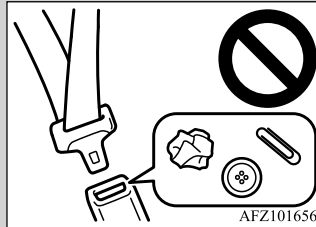

- Never modify or alter the seat belts in your vehicle.
- To reduce the risk to the driver of serious injury or death during deployment of the driver's airbag, always properly wear the seat belt and adjust the driver's seat as far back as possible while maintaining a position that still enables you to fully apply the pedals, easily control the steering wheel, and safely operate the vehicle.
- To reduce the risk to a front seat passenger of serious injury or death from a deploying airbag, make sure the passenger always wears the seat belt properly, remains seated all the way back and upright in their seat, and moves the seat as far back as possible. Refer to "Supplemental Restraint System (SRS) - airbag" on page 4-26 for additional information.

WARNING

- Never hold an infant or child in your arms or on your lap when riding in this vehicle even when you are wearing your seat belt. Never place any part of the seat belt you are wearing around an infant or child. Failure to follow these simple instructions creates a risk of serious injury or death to your child in the event of an accident or sudden stop.
- Children 12 years old and under should always ride in the rear seat and be properly restrained. This reduces their risk of serious injury or death in an accident, especially due to a deploying front passenger airbag. Refer to "Child restraint systems" on page 4-19 for additional information.
- Any child who is too small to properly wear a seat belt must be properly restrained in an appropriate child restraint system.
- Infants **MUST** be placed in a rear-facing child safety seat and positioned in the rear seat.
- In the event of an accident, all seat belt assemblies, including retractors and attachment hardware, should be inspected by an authorized Mitsubishi Motors dealer to determine whether replacement is necessary.

Seat belt instructions

N00406201500

All seats are equipped with a seat belt which uses one combined lap-and-shoulder belt with an emergency locking retractor.

This system is designed to provide both comfort and safety. It permits full extension and automatic retraction of the belts during normal vehicle operation. A sensing device inside the belt retractor is designed to lock the retractor in the event of a sudden change in the vehicle's motion.

NOTE

- For instructions on installing a child restraint system using a seat belt, refer to "Installing a child restraint system using the seat belt" on page 4-23.

Seat belts

- Occupants should always sit back in their seats with their backs against the upright seatback. To reduce the risk of serious injury or death during deployment of the airbag, adjust the driver's seat as far back as possible while maintaining a position that still enables you to fully apply the pedals, easily control the steering wheel, and safely operate the vehicle. The front passenger seat should also be moved as far back as possible. Refer to "Supplemental Restraint System (SRS) - airbag" on page 4-26. Also refer to "To adjust the seat forward or backward" on page 4-3.

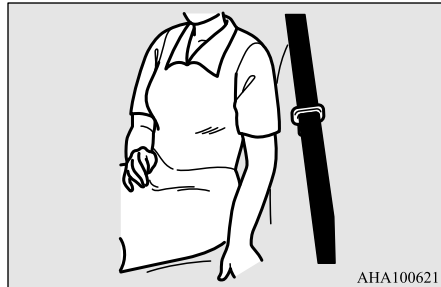

WARNING

- To reduce the risk of serious injury or death in the event of an accident or sudden stop, all seatbacks should be kept in the upright position while the vehicle is in motion.
Seat belt performance during an accident can be adversely affected if the seatbacks are reclined. The more a seatback is reclined, the more likely seat belt performance will be adversely affected. If the seat belt is not properly positioned against the body during an accident, there is increased risk you will slide under the belt and receive serious injury or death.

- Before using the rear center seat belt, make sure that the detachable anchor is securely latched and the seat belt is not twisted. For details, refer to page 4-14.
- Grasp the latch plate and slide it up the webbing so that it easily pulls across your body.



- Pull the seat belt out slowly while holding the latch plate. Push the latch plate into the buckle until you hear a "click". Pull up on the belt to be sure the latch plate is locked securely in the buckle.



4

NOTE

- If the seat belt locks up and cannot be pulled out, pull it once with force and let it retract all the way. Then, pull the belt out slowly once again.

- The lap part of the belt must always be worn low and snug across the hips. Pull up on the shoulder portion of the belt to take up any slack in the lap belt.

Seat belts

4

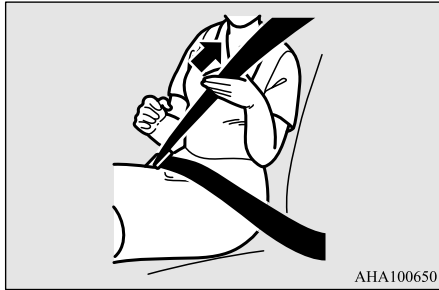

NOTE

- With the exception of the seat belt for the driver, the seat belts in all other seating positions are equipped with an Automatic Locking Retractor (ALR) function. If you pull the seat belt fully out of the retractor, the retractor will switch to its ALR child restraint installation function (see page 4-23). When the ALR function has been activated, the seat belt will only retract. If this happens, let the belt fully retract, then pull the seat belt back out, repeating steps 1 through 5.

WARNING

- Be sure the lap belt portion fits snugly and is worn as low as possible across the hips, not around the waist. Failure to follow this instruction will increase the risk of serious injury or death in the event of an accident.

WARNING

- Be sure the seat belt webbing is not twisted when worn. Twisted webbing may adversely affect seat belt performance.

- To release the belt, press the button on the buckle and allow the belt to retract. If the belt does not retract smoothly, pull it out and check for kinks or twists in the webbing. Then make sure it remains untwisted as it retracts.

NOTE

- If the seat belt (A) or ring (B) becomes dirty, the belt may not retract smoothly. If the seat belt and ring are dirty, clean them with a mild soap or detergent solution.

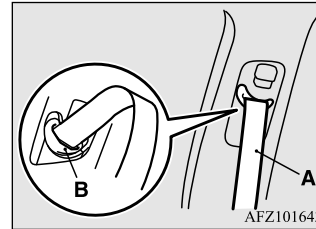

Detachable rear center seat belt

N00409700017

The rear center seat belt can be detached to help avoid damage caused by an object in the

luggage compartment while the driver's side rear seat back is folded down.

WARNING

- Never detach the rear center seat belt except when the driver's side rear seat back is folded down. Using the rear center seat belt with the detachable anchor unlatched increases the risk of serious injury or death in an accident. Make sure the detachable anchor is properly latched before the center seat belt is used.

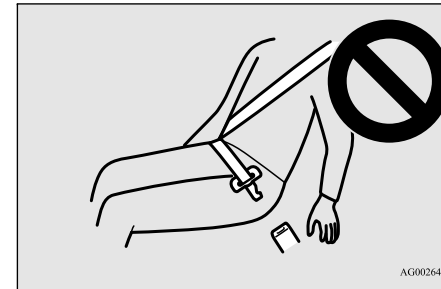

To attach

- Pull the seat belt out slowly and pass it through the seat belt guide (A).

Seat belts

4

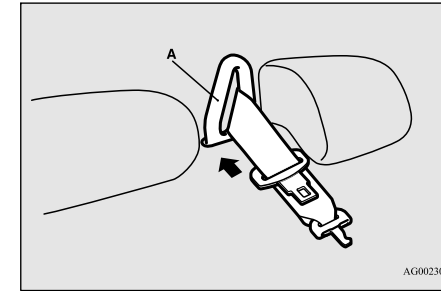
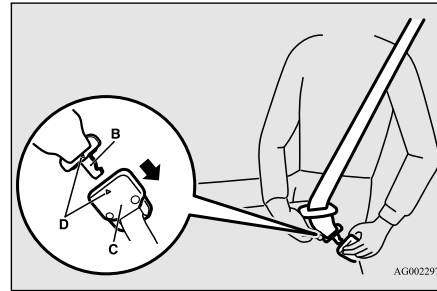
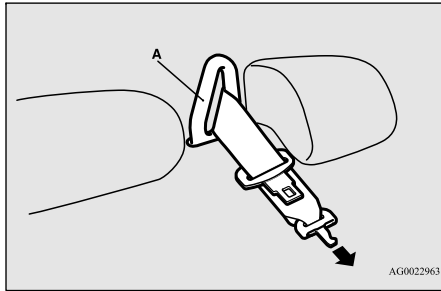

NOTE

- If the seat belt locks up and cannot be pulled out, pull it once with force and let it retract all the way. Then, pull the belt out slowly once again.

To detach

1. Insert the latch plate (E) of the center seat belt into the slit (G) on the detachable anchor (C) and release the center seat belt from the detachable anchor.

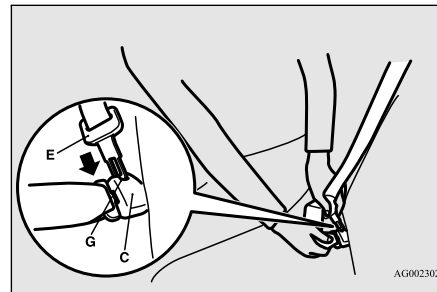

3. After the seat belt is retracted completely, insert the latch plate (E) into the upper slit (H) and the small latch plate (B) into the lower slit (I).

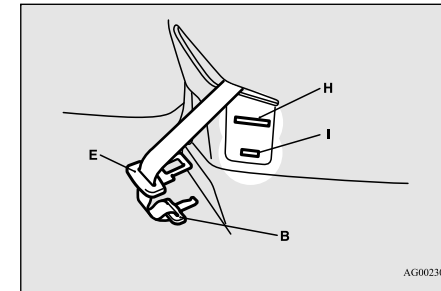

2. After making sure that the seat belt is not twisted, insert the small latch plate (B) into the detachable anchor (C) aligning the marks (D) on the plate and buckle until a “click” is heard.

2. Pass the seat belt through the seat belt guide (A) and retract it completely toward the rear trim.

Seat belts

Driver's seat belt reminder/warning light and display

N00418400342

4

Warning light



Warning display type 1



Warning display type 2



A tone and warning light are used to remind the driver to fasten the seat belt.

If the ignition switch is turned to the "ON" position or the operation mode is put in ON without the driver's seat belt being fastened, a warning light will come on and a tone will sound for approximately 6 seconds to remind you to fasten your seat belt.

If you then drive with the seat belt unfastened for longer than a minute from when the ignition switch or the engine switch is operated, the warning light will come on and blink repeatedly and the tone will sound intermittently.

The warning light and the tone will stop after approximately 90 seconds.

If you then repeatedly stop and start your vehicle with the seat belt unfastened, the warning light/display and tone will remind you to fasten your seat belt every time the vehicle starts moving. You will also be reminded to fasten your seat belt in this way when you remove your seat belt while driving. The warning light and the tone go off when the seat belt is fastened.

WARNING

- In order to reduce the risk of serious injury or death in an accident, always fasten your own seat belt. Do not allow anyone to ride in your vehicle unless he or she is also seated and fastening a seat belt. Children should additionally be restrained in a secure child restraint system.

NOTE

- At the same time, "FASTEN SEAT BELT" will be displayed on the information screen in the multi-information display.

Front passenger seat belt warning light

N00418301289

The front passenger seat belt warning light is located in the instrument panel.

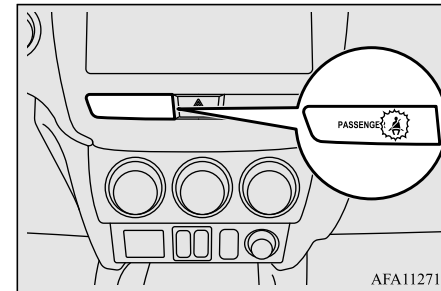

AFA112710

When the ignition switch is turned to the "ON" position or the operation mode is put in ON, this indicator normally comes on and goes off a few seconds later.

The light comes on when a person sits on the front passenger seat but does not fasten the seat belt. It goes off when the seat belt is subsequently fastened.

WARNING

- Do not install any accessory or sticker that makes the light difficult to see.

Adjustable seat belt shoulder anchor (front seats)

N00406300344

To move the anchor (A), press the lock knob (B) and slide the anchor to the desired position.

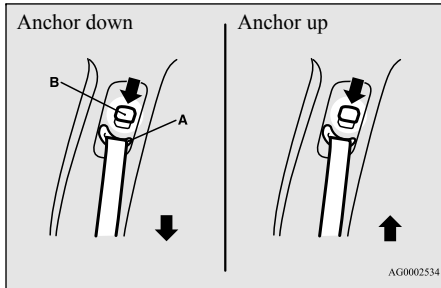

⚠ WARNING

- Always adjust the shoulder belt anchor so that the shoulder belt is positioned across the center of your shoulder without touching your neck. The shoulder belt should not be able to fall off your shoulder. Failure to follow this instruction can adversely affect seat belt performance and increase the risk of serious injury or death in the event of an accident.
- Adjust the shoulder belt anchor only when the vehicle is not in motion.

⚠ WARNING

- Make sure the anchor is securely locked in position after adjusting it.

Seat belt extender

N00406701228

When your seat belt, even fully extended, is not long enough, a seat belt extender must be obtained. The extender may be used for either of the front seats.

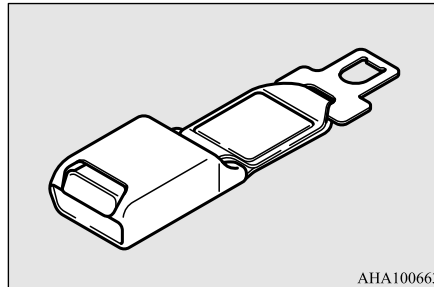

AHA100663

⚠ WARNING

- The extender should only be used if the existing belt is not long enough. Anyone who can use the standard seat belt should not use an extender. Unnecessary use of an extender can adversely affect seat belt performance in an accident.
- When not required, the extender must be removed and stowed.

Seat belt use during pregnancy

Seat belt use during pregnancy

N00406800134

Seat belts work for everyone, including pregnant women. Like all occupants, pregnant women are more likely to be seriously injured or killed in an accident if they do not wear seat belts.

4

⚠ WARNING

- To reduce the risk of serious injury or death to pregnant women and unborn children in an accident, pregnant women should always wear a seat belt. The lap portion of the seat belt should be worn snug and low across the hips and below the rounding. Consult your doctor if you have any additional questions or concerns.

Seat belt pre-tensioner and force limiter systems

N00417700641

The driver's and front passenger's seats each have a seat belt equipped with a pre-tensioner system.

Seat belt pre-tensioner and force limiter systems

Pre-tensioner system

4

The driver and front passenger seat belts are equipped with a seat belt pre-tensioner system. In a moderate-to-severe frontal or side collision or when a rollover or overturning of the vehicle is detected, the pre-tensioner system operates simultaneously with the deployment of the front airbags, side airbags or curtain airbags.

The seat belt pre-tensioners are located within the seat belt retractors (A). When activated, the pre-tensioners quickly draw back seat belt webbing and increase seat belt performance.

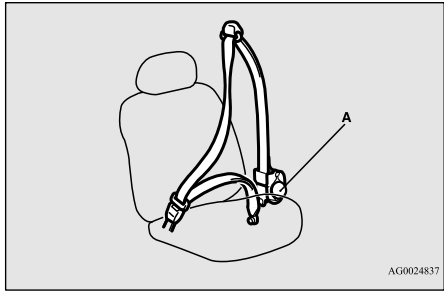

The seat belt pre-tensioner system includes the following components:

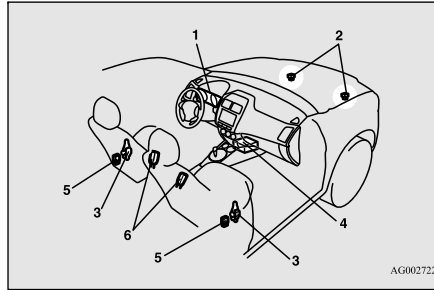

- 1- SRS warning light
- 2- Front impact sensors
- 3- Seat belt pre-tensioner
- 4- Airbag control unit
- 5- Side impact sensors
- 6- Seat belt buckle switches

The airbag control unit monitors the readiness of the electronic parts of the system whenever the ignition switch or the operation mode is under the following conditions. These include all of the items listed above and all related wiring.

[Except for vehicles equipped with the F.A.S.T.-key]

The ignition switch is in the "ON" or "START" position.

[Vehicles equipped with the F.A.S.T.-key]

The operation mode is in ON.

The seat belt pre-tensioners will operate under the same conditions as the airbag control unit.

When the seat belt pre-tensioners activate, some smoke is released and a loud noise will be heard. The smoke is not harmful, but care should be taken not to intentionally inhale it, as it may cause some temporary irritation to people with respiratory problems.

Even in the event of a severe impact, the pre-tensioners will not operate if the seat belts are not fastened. The seat belt pre-tensioners may not activate in certain collisions, even though the vehicle may appear to be severely damaged. Such non-activation does not mean that something is wrong with the seat belt pre-tensioner system, but rather that the collision forces were not severe enough to activate the system.

WARNING

- The seat belt pre-tensioner system is designed to work only once. After the seat belt pre-tensioners have been activated, they will not work again. They must promptly be replaced and the entire seat belt pre-tensioner system inspected by an authorized Mitsubishi Motors dealer.

SRS warning

N00408700081

This warning light tells you if there is a problem involving the SRS airbags and the seat belt pre-tensioner system. Refer to “SRS warning light/display” on page 4-32.

Force limiter system

N00408901149

In the event of an accident, the seat belt force limiter system will help reduce the force applied to the driver and front seat passenger.

Child restraint systems

N00407101724

When transporting infants or small children in your vehicle, an appropriate child restraint system must always be used. This is required by law in the U.S. and Canada.

Child restraint systems specifically designed for infants and small children are offered by several manufacturers. Choose only a child restraint system with a label certifying that it complies with Federal Motor Vehicle Safety Standard 213 (FMVSS 213) or Motor Vehicle Restraint Systems and Booster Seats Safety Regulations (RSSR). Look for the manufacturer’s statement of compliance on the box and child restraint system itself.

The child restraint system should be appropriate for your child’s weight and height, and should properly fit your vehicle’s seat.

For detailed information, refer to the instruction manual accompanying the child restraint system.

Guidelines for child restraint system selection

All children should be properly restrained in a restraint device that offers the maximum protection for their size and age.

Be sure to check local, state, or provincial requirements for child size and age that may vary from the recommendations listed below.

- Children less than 1 year old and who weigh 22 pounds (10 kg) or less **MUST** ride in a rear-facing child safety seat that **MUST ONLY** be used in the rear seat.
- Children older than 1 year of age and who weigh less than 40 pounds (18 kg) or who are less than 40 inches (100 cm) tall **MUST** be in a forward-facing restraint that **MUST ONLY** be used in the rear seat.

Child restraint systems

- Children who weigh more than 40 pounds (18 kg) or who are more than 40 inches (100 cm) tall, regardless of age, should use a suitable child seat or a booster seat in the rear seat until the vehicle’s lap-and-shoulder belt fits them properly.

4

⚠ WARNING

- **All children must be seated in the rear seat, and properly restrained. Accident statistics show that children of all sizes and ages are safer when properly restrained in the rear seat, rather than in the front seat.**
- **Any child who is too large to use a child restraint system should ride in the rear seat and wear the lap-and-shoulder belt properly. The shoulder belt must be positioned over the shoulder and across the chest, not across their neck, and with the lap belt positioned low on the child’s hips, not across their stomach. If necessary, a booster seat should be used to help achieve a proper seat belt fit. Follow the booster seat manufacturer’s instructions. Only use a booster seat that is certified as complying with Federal Motor Vehicle Safety Standards or Motor Vehicle Restraint Systems and Booster Seats Safety Regulations.**

Child restraint systems

4

⚠ WARNING

- Never hold an infant or child in your arms or on your lap when riding in this vehicle, even when you are wearing your seat belt. Never place any part of the seat belt you are wearing around an infant or child. Failure to follow these simple instructions creates a risk of serious injury or death to your child in the event of an accident or sudden stop.



⚠ WARNING

- Your vehicle is also equipped with a front passenger airbag. Never put REAR-FACING CHILD RESTRAINT SYSTEMS or INFANT RESTRAINT SYSTEMS in the front passenger seat. This places the infant too close to the passenger airbag. During deployment of that airbag, the infant can be seriously injured or killed. Rear-facing child restraint systems or infant restraint systems must only be used in the rear seat.

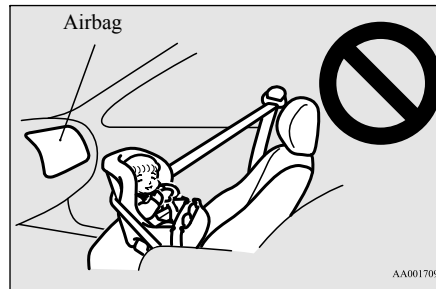

⚠ WARNING

- FRONT-FACING CHILD RESTRAINT SYSTEMS should be used in the rear seat whenever possible. If one must be used in the front passenger seat, move the seat to the most rearward position and make sure the child stays in the child restraint system, properly restrained. Failure to follow these instructions could result in serious injury or death to the child.



⚠ WARNING

- It is important to use an approved rear-facing infant restraint until the infant is one year old (unless the infant outgrows the seat sooner). This allows the infant's neck and spine to develop enough to support the weight of their head in the event of an accident.

⚠ WARNING

- When installing a child restraint system, follow the instructions provided by the manufacturer and follow the directions in this manual. Failure to do so can result in serious injury or death to your child in an accident or sudden stop.
- After installation, push and pull the child restraint system back and forth, and side to side, to see that it is firmly secured. If the child restraint system is not installed securely, it may cause injury to the child or other occupants in the event of an accident or sudden stop.
- When not in use, keep your child restraint system secured with the seat belt, or remove it from the vehicle, in order to prevent it from being thrown around inside the vehicle during an accident.

📖 NOTE

- Before purchasing a child restraint system, try installing it in the rear seat to make sure there is a good fit. Because of the location of the seat belt buckles and the shape of the seat cushion, it may be difficult to securely install some manufacturer's child restraint systems. If the child restraint system can be pulled forward or to either side easily on the seat cushion after the seat belt has been tightened, choose another manufacturer's child restraint system. Depending on the seating position in the vehicle and the child restraint system that you have, the child restraint system can be attached using one of the following 2 methods:
 - Attach to the lower anchorage in the rear seat **ONLY** if the child restraint system is compatible with the LATCH system (See page 4-21).
 - Attach to the seat belt (See page 4-23).

Installing a child restraint system using the LATCH (Lower Anchors and Tethers for children) system

N00418800128

4**Lower anchor locations**

The outboard seating positions in the rear seat of your vehicle are equipped with lower anchors for attaching child restraint systems compatible with the LATCH system.

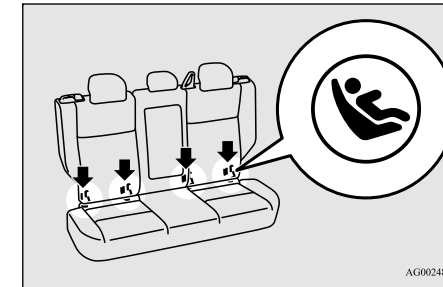
**📖 NOTE**

- The symbols on the seatback show the location of the lower anchor points.

Child restraint systems

Tether anchor locations

N00418901214

Your vehicle has 3 attachment points on the backside of the rear seats. These are for securing a child restraint system tether strap to each of the 3 rear seating positions in your vehicle.

4

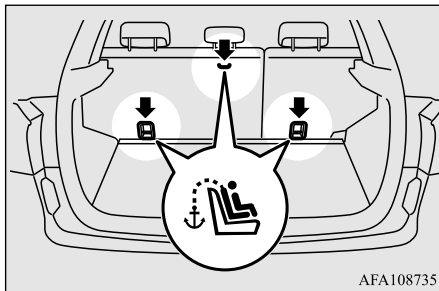

Examples of child restraint systems compatible with the LATCH system

N00419001209

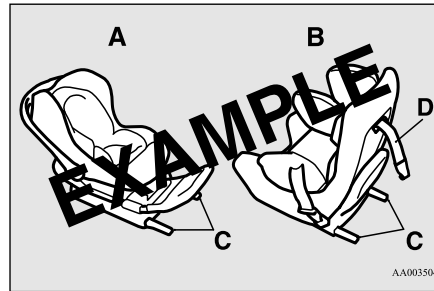

- A- Rear-facing child restraint system
 - B- Front-facing child restraint system
 - C- Child restraint system lower anchor connectors
 - D- Tether strap
- (These are only examples.)

Using the LATCH system

N00419101327

1. In order to securely fasten the tether strap, remove the head restraint from the location where you wish to install the child restraint system.
2. Open a small gap between the seat cushion (A) and the seatback (B) with your hand to locate the lower anchors (C).

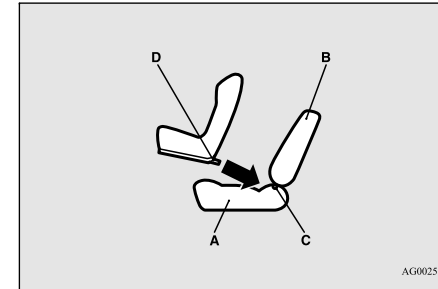

- A- Vehicle seat cushion
- B- Vehicle seatback
- C- Lower anchor
- D- Connector

3. Push the anchor connectors (D) on the child restraint system into the lower anchors (C) in accordance with the instructions provided by the child restraint system's manufacturer.

Remember, the lower anchors provided with your vehicle are designed to secure suitable child restraint systems compatible with the LATCH system in the outboard positions of the rear seats only. The anchor connectors are NOT designed to secure a suitable child restraint system in the center position of the rear seat.

Child restraint systems

NOTE

- In order to secure a child restraint system compatible with the LATCH system, use the lower anchor points in the outboard positions of the rear seat. It is not necessary to use the vehicle's seat belt. The vehicle's seat belt, however, **MUST** be used to secure a child restraint system in the center position of the rear seat.

WARNING

- If there is any foreign material in or around the lower anchors, remove it before installing the child restraint system. Also, make sure the seat belt is away from, not looped through or otherwise interfering with, the child restraint system. If foreign matter is not removed and/or the seat belt interferes with the child restraint system, the child restraint system will not be secured properly, could detach and move forward in the event of sudden braking or an accident, and could result in injury to the child or other vehicle occupants.
- When the vehicle is moving, do not adjust the seat where the child restraint system is installed.

5. Latch the tether strap hook (E) of the child restraint system to the tether anchor bar (F) and tighten the tether strap so it is securely fastened.

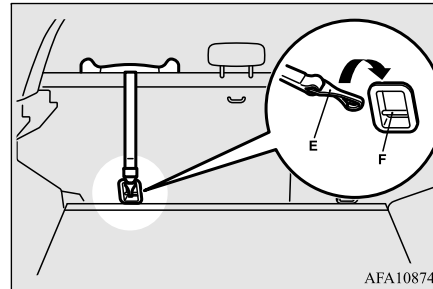

6. Push and pull the child restraint system in all directions to be sure it is firmly secured.

WARNING

- Child restraint system tether anchors are designed only to withstand loads from correctly fitted child restraint systems. Under no circumstances are they to be used for adult seat belts, or harnesses, or for attaching other items or equipment to the vehicle.

Installing a child restraint system using the seat belt (with emergency/automatic locking mechanism)

N00407301579

4

With the exception of the driver's seat, the seat belt in all other seating positions can be converted from normal Emergency Locking Retractor (ELR) mode to Automatic Locking Retractor (ALR) mode. This means that when you pull the seat belt fully out of the retractor, the retractor will switch to its ALR child restraint installation function. Always use the ALR child restraint installation function when you install a child restraint system using the seat belt.

Children 12 years old and under should always be restrained in the rear seat whenever possible, although the front passenger seat belt can also be converted to ALR mode.

4. Remove the cargo area cover from the vehicle. (Refer to "Cargo area cover" on page 5-171.)

Child restraint systems

4

⚠ WARNING

- When you install a child restraint system using the seat belt, always make sure the retractor has been switched to the ALR child restraint installation function. The ALR function will keep the child restraint system tightly secured to the seat. Failure to convert the retractor to the ALR function may allow the child restraint system to move forward during sudden braking or an accident, resulting in serious injury or death to the child or other occupants.
- When you install a child restraint system using the 3-point type seat belt with 2 buckles in the rear center seating position, always make sure both latch plates are secured. Do not use the seat belt with only one of the latch plates attached. This could result in a serious injury or death in the event of an accident or sudden stop.

Installation

1. Place the child restraint system on the seat where you wish to install it.
To help assure proper fitting of the child restraint system, always remove the head restraint.

2. Route the seat belt through the child restraint system's according to the instructions provided by the child restraint system's manufacturer. Then insert the seat belt latch plate into the buckle. Make sure you hear a "click" when you insert the latch plate into the buckle.

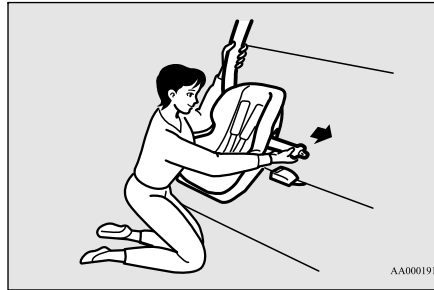

3. To activate the ALR child restraint installation function, slowly pull the shoulder part of the belt all the way out of the retractor until it stops. Then let the belt feed back into the retractor.

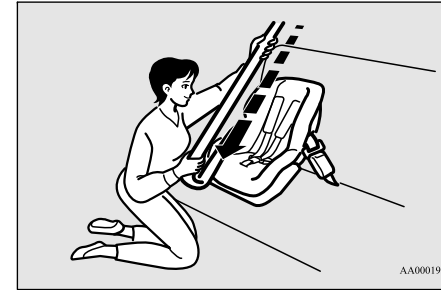

4. After the belt has retracted, tug on it.
If the belt is in the ALR function, you will not be able to pull it out. If the webbing can be pulled out from retractor, the ALR function has not been activated and you will need to repeat steps 3 and 4.
5. After confirming that the belt is locked, grab the shoulder part of the belt near the buckle and pull up to remove any slack from the lap part of the belt, allowing the slack to feed into the retractor. Remember, if the lap belt portion is not tight, the child restraint system will not be secure. It may help to put your weight on the child restraint system and/or push on its seat-back while pulling up on the belt (See illustration).

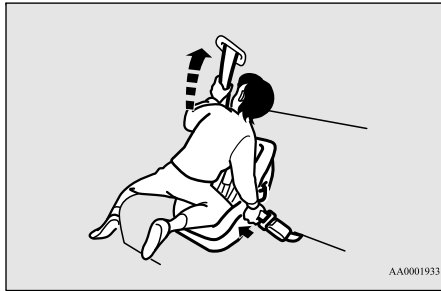

If your child restraint system requires the use of a tether strap, fasten the tether strap in accordance with the following procedures.

6. Remove the cargo area cover from the vehicle. (Refer to “Cargo area cover” on page 5-171.)
7. Latch the tether strap hook (A) of the child restraint system to the tether anchor bar (B) and tighten the tether strap so it is securely fastened.

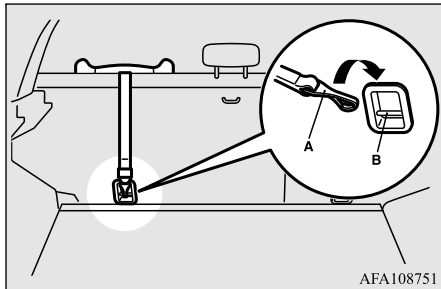

WARNING

● Child restraint system tether anchors are designed only to withstand loads from correctly fitted child restraint systems. Under no circumstances are they to be used for adult seat belts, or harnesses, or for attaching other items or equipment to the vehicle.

8. Before putting your child in the restraint, push and pull the restraint in all directions to be sure it is firmly secure. Do this before each use. If the child restraint system is not firmly secure, repeat steps 1 through 7.
9. To remove a child restraint system from the vehicle and deactivate the ALR mode, remove the child from the restraint. Unlatch the buckle. Then remove the belt from the restraint and let the belt fully retract.
10. Reinstall the head restraint.
Refer to “Head restraints” on page 4-7.

Children who have outgrown child restraint systems

N00407601673

Children who have outgrown a child restraint system should be seated in the rear seat and wear the seat belt. If the shoulder belt crosses their face or neck, and/or the lap belt crosses

Child restraint systems

their stomach, a commercially available booster seat must be used to raise the child so that the shoulder belt crosses their shoulder and the lap belt remains positioned low across their hips. The booster seat should fit the vehicle seat and have a label certifying compliance with Federal Motor Vehicle Safety Standards or Motor Vehicle Restraint Systems and Booster Seats Safety Regulations.

4

WARNING

- Any child who is too small to properly wear a seat belt must be properly restrained in an appropriate child restraint system, to reduce their risk of serious injury or death in an accident.
- A child should never be left unattended in, or unsupervised around, your vehicle. When you leave the vehicle, always take the child out as well.
- Children can die from heat stroke if left or trapped inside the vehicle, especially on hot days.
- Keep your vehicle locked when not in use. Keep your vehicle keys away from children.

Maintenance and inspection of seat belts

Maintenance and inspection of seat belts

N00407001374

4

Regularly check your seat belt buckles and their release mechanisms for positive engagement and release of the latch plate. Check the retractors for automatic locking when in the Automatic Locking Retractor function.

The entire seat belt assembly should be replaced if the webbing shows any obvious cuts, tears, increase in thickness in any section of the webbing from broken fibers, or severe fading from sunlight. All of these conditions indicate a weakening of the belt, which may adversely affect seat belt performance in an accident.

WARNING

● Do not attempt to repair or replace any part of the seat belt assemblies. This work should be done by an authorized Mitsubishi Motors dealer. Failure to have an authorized Mitsubishi Motors dealer perform the work could reduce the effectiveness of the belts and could result in a serious injury or death in an accident.

WARNING

● Never use an organic solvent to clean the seat belt webbing. Do not attempt to bleach or re-dye the seat belt webbing. These may weaken the seat belt webbing, increasing risk of injury or death in an accident.

Clean seat belt webbing only with mild soap or detergent solution and rinse it with lukewarm water, and dry the seat belt webbing completely before retracting it.

Supplemental Restraint System (SRS) - airbag

N00407701762

This vehicle is equipped with a Supplemental Restraint System (SRS), which includes airbags for the driver and passengers.

The SRS front airbags are designed to supplement the primary protection of the driver and front passenger seat belt systems by providing those occupants with protection against head and chest injuries in certain moderate to severe frontal collisions. The SRS front airbags, together with sensors at the front of the vehicle and sensors attached to the front seats, form an advanced airbag system.

The SRS driver's knee airbag is designed to supplement the primary protection of the

driver's seat belt system. It can reduce the forward movement of the driver's lower legs and provide increased overall body protection in certain moderate to severe frontal collisions.

The SRS side airbags and the curtain airbags are also designed to supplement the seat belts. The SRS side airbags provide the driver and front passenger with protection against chest injuries by deploying the bag on the side impacted in moderate to severe side impact collisions. The SRS curtain airbags provide the driver and the passengers on the front seat and the rear outboard seats with protection against head injuries by deploying the curtain airbag on the side impacted in moderate to severe side impact collisions and by deploying both curtain airbags when a rollover is detected. The curtain airbags are also designed to help reduce the risk of complete and partial ejection from the vehicle through side windows in both side impact and rollover type accidents.

The SRS airbags are NOT a substitute for use of the seat belts. For maximum protection in all types of accidents, seat belts must ALWAYS be worn by everyone who drives or rides in this vehicle (with infants and small children in an appropriate child restraint system in the rear seat, and older children buckled in the rear seat). Refer to "Child restraint

Supplemental Restraint System (SRS) - airbag

systems” on page 4-19.

⚠ WARNING

- **IT IS VERY IMPORTANT TO ALWAYS WEAR YOUR SEAT BELT PROPERLY EVEN WITH AN AIRBAG.**

- Seat belts help keep the driver and passengers properly positioned. This reduces the risk of injury in all collisions, and reduces the risk of serious injuries or death when the airbags inflate. During sudden braking just before a collision, an unrestrained or improperly restrained driver or passengers can move forward into direct contact with, or within close proximity to, the airbag when it begins to inflate.

The beginning stage of airbag inflation is the most forceful and can cause serious injuries or death if the occupant comes in contact with the airbag at this time.

- Seat belts reduce the risk of injury in rear impact collisions, and in lower-speed frontal collisions because the airbags are not designed to inflate in those situations.

- Seat belts reduce the risk of being thrown from your vehicle in a collision or rollover.

- **IT IS VERY IMPORTANT TO BE PROPERLY SEATED.**

⚠ WARNING

- A driver or front passenger sitting too close to the steering wheel or instrument panel during airbag deployment can be seriously injured or killed.
- Airbags inflate very quickly and with great force. If the driver and front passenger are not properly seated and restrained, the airbag may not provide the proper protection, and can cause serious injuries or death when it inflates.
- To reduce the risk to the driver of serious injury or death due to a deploying driver's airbag, always properly wear your seat belt and adjust the driver's seat as far back as possible, maintaining a position that still allows the driver to have good control of the steering wheel, brake, accelerator, and other vehicle controls.
- To reduce the risk to the front passenger of serious injury or death from a deploying passenger's airbag, make sure the passenger always wears the seat belt properly, remains seated upright and all the way back in the seat, and positions the seat as far back as possible.
- Seat all infants and children in the rear seat, properly restrained in an appropriate child restraint system.

⚠ WARNING

- Airbags inflate very quickly and with great force. Do not sit on the edge of the seat or sit with your lower legs too close to the instrument panel, or lean your head or chest close to the steering wheel or the instrument panel.
- Do not put your feet or legs on or against the instrument panel.

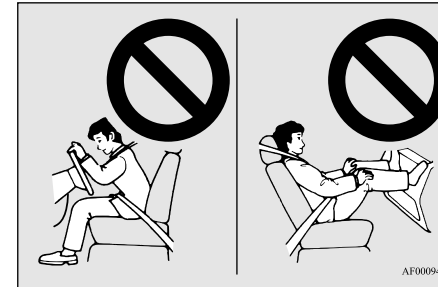
**⚠ WARNING**

- Infants and small children should never ride unrestrained, or lean against the instrument panel. They should never ride held in your arms or on your lap. They can be seriously injured or killed in an accident, especially when the airbags inflate. Seat all infants and children in the rear seat, properly restrained in an appropriate child restraint system. Refer to “Child restraint systems” on page 4-19.

Supplemental Restraint System (SRS) - airbag

4

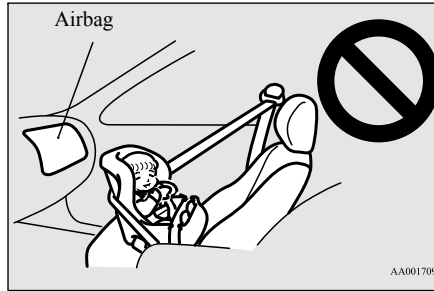
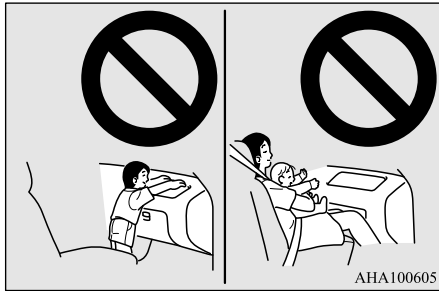

⚠ WARNING

- **NEVER** put **REAR-FACING CHILD RESTRAINT SYSTEMS** or **INFANT RESTRAINT SYSTEMS** in the front passenger seat. This places the infant too close to the passenger airbag. During deployment of that airbag, the infant can be seriously injured or killed. Rear-facing child restraint systems or infant restraint systems must only be used in the rear seat.

⚠ WARNING

- **FRONT-FACING CHILD RESTRAINT SYSTEMS** should be used in the rear seat whenever possible. If they must be used in the front passenger seat, move the seat to the most rearward position and make sure the child stays in the child restraint system, properly restrained. Failure to follow these instructions could result in serious injury or death to the child.

⚠ WARNING

- Older children should be seated in the rear seat with their seat belt properly worn, and with an appropriate booster seat if needed. Refer to “Children who have outgrown child restraint systems” on page 4-25.

How the Supplemental Restraint System works

N00407800450

The SRS includes the following components:

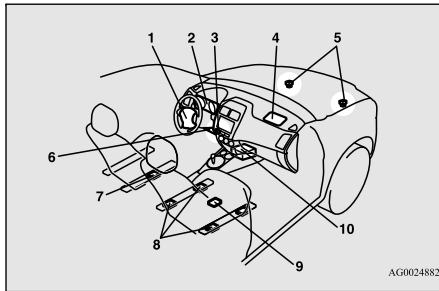

AG0024882

- 1- Airbag module (Driver)
- 2- SRS warning light
- 3- Passenger's airbag off indicator
- 4- Airbag module (Passenger)
- 5- Front impact sensors
- 6- Airbag module (Driver's knee)
- 7- Driver's seat position sensor
- 8- Passenger's seat weight sensors
- 9- Weight control unit
- 10- Airbag control unit

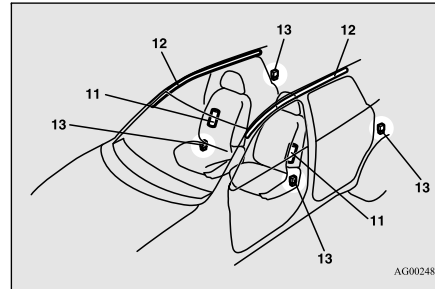

AG0024895

- 11- Side airbag modules
- 12- Curtain airbag modules
- 13- Side impact sensors

The airbag control unit monitors the readiness of the electronic parts of the system whenever the ignition switch or the operation mode is under the following conditions. These include all of the items listed above and all related wiring.

[Except for vehicles equipped with the F.A.S.T.-key]

The ignition switch is in the "ON" or "START" position.

[Vehicles equipped with the F.A.S.T.-key]

The operation mode is in ON.

The airbags will operate under the same conditions as the airbag control unit.

Supplemental Restraint System (SRS) - airbag

When the impact sensors detect a sufficient front or side impact to deploy the airbag(s), the appropriate airbag(s) will be deployed.

When the airbag control unit detects rollover of the vehicle, curtain airbags will be deployed.

4

When airbags deploy, some smoke is released accompanied by a loud noise. The smoke is not harmful, but do not intentionally inhale the smoke as it may cause temporary irritation to people with respiratory problems.

An inflated airbag will deflate quickly, so you may not even notice that the airbag was inflated.

Airbag inflation does not prevent the driver from seeing or being able to steer the vehicle, and does not prevent people from leaving the vehicle.

CAUTION

- Airbags inflate very quickly and with great force. In certain situations, contact with an inflating airbag may cause small cuts, abrasions, and bruises.

Event Data Recording

N00418600243

This vehicle is equipped with an event data recorder (EDR).

Seat and restraint systems 4-29



Supplemental Restraint System (SRS) - airbag

4

The main purpose of an EDR is to record, in certain crash or near crash-like situations, such as an airbag deployment or hitting a road obstacle, data that will assist in understanding how a vehicle's systems performed.

The EDR is designed to record data related to vehicle dynamics and safety systems for a short period of time, typically 30 seconds or less.

The EDR in this vehicle is designed to record such data as:

- How various systems in your vehicle were operating;
- Whether or not the driver and passenger safety belts were buckled/fastened;
- How far (if at all) the driver was depressing the accelerator and/or brake pedal; and,
- How fast the vehicle was traveling.

These data can help provide a better understanding of the circumstances in which crashes and injuries occur.

NOTE

- EDR data are recorded by your vehicle only if a non-trivial crash situation occurs; no data are recorded by the EDR under normal driving conditions and no personal data (e.g., name, gender, age, and crash location) are recorded. However, other parties, such as law enforcement, could combine the EDR data with the type of personally identifying data routinely acquired during a crash investigation.

To read data recorded by an EDR, special equipment is required, and access to the vehicle or the EDR is needed. In addition to the vehicle manufacturer, other parties, such as law enforcement, that have the special equipment, can read the information if they have access to the vehicle or the EDR.

Driver's seat position sensor

N00417900177

The driver's seat position sensor is attached to the seat rail and provides the airbag control unit with information on the seat's fore-aft position. The airbag control unit controls deployment of the driver's front airbag in accordance with the information it receives from this sensor.

If there is a problem involving the driver's seat position sensor, the SRS warning light in the instrument panel will come on. Refer to

"SRS warning light/display" on page 4-32.

WARNING

- **If the SRS warning light or warning display comes on, have the vehicle inspected by an authorized Mitsubishi Motors dealer as soon as possible.**
- **Please observe the following instructions to ensure that the driver's seat position sensor can operate correctly.**
 - **Adjust the seat to the correct position, and sit well back against the seatback. Refer to "Front seats" on page 4-3.**
 - **Do not recline the seatback more than necessary when driving.**
 - **Do not place metallic objects or luggage under the front seat.**
- **If the vehicle is involved in a severe impact, have the SRS sensors inspected by an authorized Mitsubishi Motors dealer as soon as possible.**

Passenger's seat weight sensors

N00418000322

The passenger's seat weight sensors are attached to the seat rails and provide the airbag control unit with information regarding the weight on the front passenger seat. The airbag control unit controls deployment of the passenger's front airbag in accordance with the information it receives from this sensor.

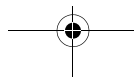

Supplemental Restraint System (SRS) - airbag

The passenger's front airbag will not deploy in an impact when the weight on the seat is sensed to be less than approximately 66 pounds (30 kg). In this case, the passenger airbag off indicator will come on. Refer to "Passenger's airbag off indicator" on page 4-31.

If there is a problem involving the passenger seat weight sensors, the SRS warning light in the instrument panel will come on. Refer to "SRS warning light/display" on page 4-32.

WARNING

- If any of the following conditions occur, you should have your vehicle inspected by an authorized Mitsubishi Motors dealer as soon as possible:
 - The SRS warning light does not initially come on when the ignition switch or the operation mode is under the following conditions.
 - [Except for vehicles equipped with the F.A.S.T.-key]
The ignition switch is in the "ON" or "START" position.
 - [Vehicles equipped with the F.A.S.T.-key]
The operation mode is in ON.
 - The SRS warning light does not go out after several seconds.
 - The SRS warning light comes on while you are driving.

WARNING

- To ensure that the passenger's seat weight sensors can correctly sense the weight being applied to the seat, observe the following instructions. Failure to follow these instructions can adversely affect the performance of the passenger's airbag system.
 - Adjust the seat to the correct position, and sit well back against the seatback. Refer to "Front seats" on page 4-3.
 - Do not recline the seatback more than necessary.
 - Never have more than one person (adult or child) sitting on the seat.
 - Do not place anything between the seat and the floor console.
 - Do not hang anything on the front passenger's seatback.
 - Do not remove the head restraints.
 - When attaching a child restraint system, secure it firmly.
 - Do not place luggage or other objects on the seat.
 - Do not use a seat cover or a cushion.
 - Do not remove the seats and seat belts.
 - Do not modify or replace the seat and seat belt.
 - Do not place luggage or other objects under the seat.
 - Do not place the floor mat on the seat rails.

WARNING

- Do not expose the sensors to liquids or vapors.
- Do not subject the sensors to shock.
- Do not allow rear-seat occupants to push the front passenger seat with their feet or force the front passenger seat upward.
- Do not allow rear-seat occupants to grasp the front passenger's seatback or put their arms around it.
- When attaching a child restraint system in the rear seat, make sure it does not interfere with the front seat.
- If the vehicle is involved in a severe impact, have the SRS sensors inspected by an authorized Mitsubishi Motors dealer as soon as possible.

4**Passenger's airbag off indicator**

N00418101388

The passenger airbag off indicator is located in the instrument panel.

Supplemental Restraint System (SRS) - airbag

4

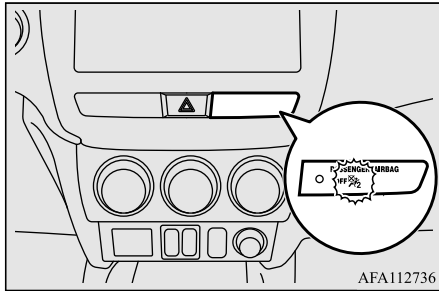

The indicator normally comes on when the ignition switch is turned to the “ON” position or the operation mode is put in ON, and goes out a few seconds later. In the following situations, the indicator will stay on to show that the passenger front airbag is not operational.

- The passenger’s seat weight sensors sense a weight of less than approximately 66 pounds (30 kg) on the front passenger seat.
- The front passenger’s seat is not occupied.

When the weight applied to the front passenger seat is sensed to be approximately 66 pounds (30 kg) or greater, the indicator goes out to show that the passenger’s front airbag is operational.

WARNING

- If any of the following conditions occur, you should have the airbag system in your vehicle inspected by an authorized Mitsubishi Motors dealer as soon as possible:
 - The passenger’s airbag off indicator comes on when an adult is sitting on the front passenger seat.
 - The passenger’s airbag off indicator does not come on when the front passenger seat is not occupied.
 - The passenger’s airbag off indicator does not come on when the ignition switch is turned to the “ON” position or the operation mode is put in ON.
 - The passenger’s airbag off indicator comes on and goes out repeatedly.
- Do not attach any accessory to your vehicle that makes the passenger’s airbag off indicator difficult or impossible to see. You must be able to see the passenger’s airbag off indicator and verify the status of the passenger’s airbag system.

SRS warning light/display

N00408301592

Warning light



Warning display type 1



Warning display type 2



The system checks itself every time the ignition switch is turned to the “ON” position or the operation mode is put in ON. The SRS warning light will come on for several seconds and then go out. This is normal and means the system is working properly.

If there is a problem involving one or more of the SRS components, the warning light will come on and stay on. At the same time, the warning display will appear on the information screen in the multi information display.

The SRS warning light/display is shared by the SRS airbag and the seat belt pre-tensioner system.

Supplemental Restraint System (SRS) - airbag

⚠ WARNING

● If any of the following conditions occur, there may be a problem with the SRS airbags and/or seat belt pre-tensioners, and they may not function properly in a collision or may suddenly activate without a collision:

- Even when the ignition switch or the operation mode is in ON, the SRS warning light does not come on or it remains on.
- The SRS warning light and/or the warning display comes on while driving.

The SRS airbags and seat belt pre-tensioners are designed to help reduce the risk of serious injury or death in certain collisions. If either of the above conditions occurs, immediately have your vehicle checked by an authorized Mitsubishi Motors dealer.

ger's airbag does not deploy when the front passenger seat is not occupied or when the weight sensor in the front passenger seat senses a weight on the seat of less than approximately 66 pounds (30 kg).

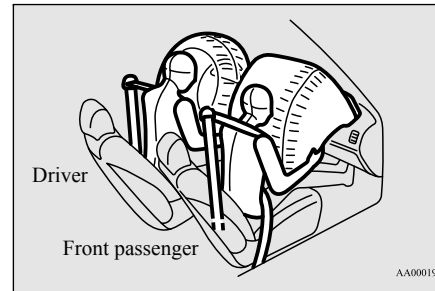

4

Driver's and passenger's front airbag system

N00407900291

The driver's airbag is located under the padded cover in the middle of the steering wheel. The front passenger's airbag is contained in the instrument panel above the glove compartment. The driver's airbag and the front passenger's airbag are designed to deploy at the same time. However, the front passen-

Driver's knee airbag system

N00404500010

The driver's knee airbag is located under the steering wheel. The driver's knee airbag is designed to deploy at the same time as the driver's front airbag.

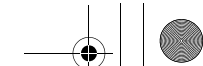

Supplemental Restraint System (SRS) - airbag

Deployment of front airbags

N00408000592

The front airbags and driver's knee airbag ARE DESIGNED TO DEPLOY when ...

4

Head-on collision with a solid wall at speeds of approx. 15 mph (25 km/h) or higher

Moderate to severe frontal impact within the shaded area between the arrows

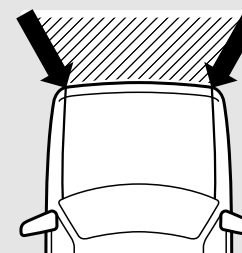
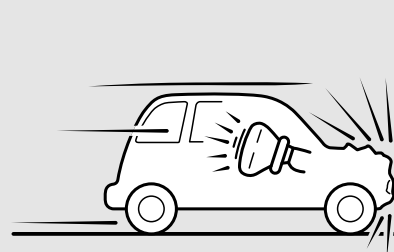

AA1000050

The front airbags and driver's knee airbag are designed to deploy when the vehicle suffers a moderate to severe frontal impact. Typical situations are shown in the illustration above.

The front airbags and driver's knee airbag are designed to deploy only in certain moderate to severe frontal collisions within the shaded area between the arrows in the illustration to the right.

The front airbags and driver's knee airbag will deploy if the impact to the vehicle's main

structure is above a specific threshold level. The threshold level is approximately 15 mph (25 km/h) for a frontal collision straight into a solid flat wall that does not bend or deform. If the impact to the vehicle's main structure is below this threshold level, the front airbags and driver's knee airbag may not deploy. This threshold level may also be higher if the vehicle hits something that absorbs the impact, either by bending or moving (for example, another stationary vehicle, a pole or a guard rail).

The beginning stage of airbag inflation is the most forceful and can cause serious injury or death if you are close to the deploying airbag. Accordingly, it is important that you always wear the available seat belt.



Supplemental Restraint System (SRS) - airbag

The front airbags and driver's knee airbag MAY NOT DEPLOY when ...

In certain types of front collisions, the front airbags and driver's knee airbag may not deploy, even if the deformation of the body seems to be large, because the vehicle's body structure is designed to absorb the impact and deform in order to help protect the occupants. Some typical situations where the front airbags and driver's knee airbag may not deploy are shown in the illustrations.

Because the front airbags and driver's knee airbag do not protect the occupant in all types of frontal collisions, be sure to always wear your seat belts properly.

Collision with a utility pole, tree or other narrow object

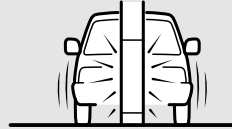

Collision where the vehicle slides under the rear body of a truck

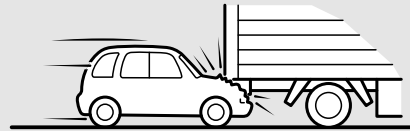

Oblique frontal impact

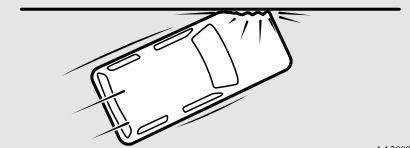

AA2000233

The front airbags and driver's knee airbag ARE NOT DESIGNED TO DEPLOY when ...

The front airbags and driver's knee airbag are not designed to deploy in situations where

they cannot provide protection to the occupants. Typical situations are shown in the illustration.

Because the front airbags and driver's knee airbag do not protect the occupants in all types of collisions, be sure to always wear the seat belts properly.

4

Rear end collision to your vehicle



Side collision to your vehicle

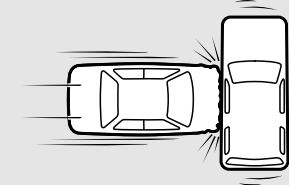

Vehicle rolls onto its side or roof



AA2000220

Supplemental Restraint System (SRS) - airbag

The front airbags and driver's knee airbag MAY DEPLOY when ...

4

The front airbags and driver's knee airbag may deploy if the underside of the vehicle suffers a moderate to severe impact (under-carriage impact). Typical situations are shown in the illustration.

Because the front airbags and driver's knee airbag may deploy in certain types of unexpected impacts, as shown in the illustrations, and these unexpected impacts can move you out of position, it is important to always wear the seat belts properly. When worn properly, seat belts can help maintain your distance from the airbags when they begin to inflate. The beginning stage of airbag inflation is the most forceful and can cause serious injury or death if you are close to the deploying airbag.

Collision with an elevated median/island or curb



Vehicle travels over a deep hole/pothole

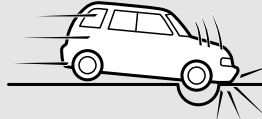

Vehicle drives down a steep slope and hits the ground

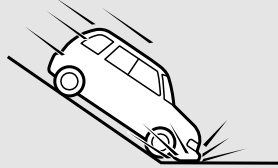

AA2000073

WARNING

- Do not attach anything to the steering wheel's padded cover, such as trim material, badges, etc. These could strike and injure an occupant if the airbag inflates.
- Do not set anything on, or attach anything to, the instrument panel above the glove compartment. Such items could strike and injure an occupant if the airbag inflates.

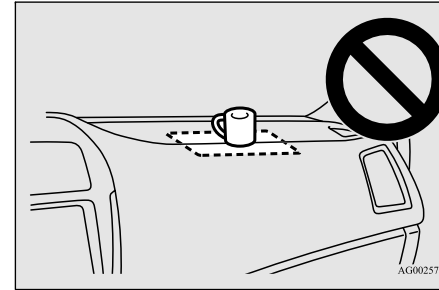

AG0025717

WARNING

- Do not attach accessories to, or put them in front of, the windshield. They could restrict the airbag inflation, or strike and injure an occupant, when the airbag inflates.
- Do not attach additional keys or accessories (hard, pointed or heavy objects) to the ignition key. Such objects could prevent the driver's knee airbag from inflating normally or could be propelled to cause serious injury if the airbag inflates.
- Do not attach accessories to the lower portion of the driver's side instrument panel. Such objects could prevent the driver's knee airbag from inflating normally or could be propelled to cause serious injury if the airbag inflates.

Supplemental Restraint System (SRS) - airbag

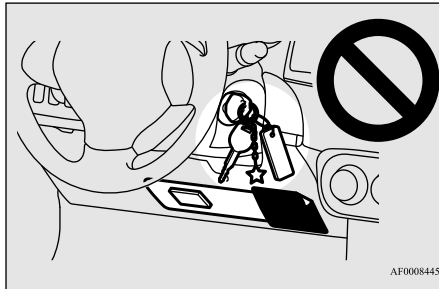

AF0008445

WARNING

- Do not attempt to remove, install, disassemble or repair the SRS airbags.
- Do not place objects, such as packages or pets, between the airbags and the driver or the front passenger. Such objects can adversely affect airbag performance, or cause serious injury or death when the airbag deploys.
- Immediately after airbag inflation, some parts of the airbag system will be hot. Do not touch them. You could otherwise be burned.
- The airbag system is designed to work only once. After the airbags deploy, they will not work again. They must promptly be replaced and the entire airbag system must be inspected by an authorized Mitsubishi Motors dealer.

Side airbag system

N00408100391

The side airbags (A) are contained in the driver and front passenger seatbacks. The side airbag is designed to inflate only on the side of the vehicle that is impacted, even with no passenger in the front seat.

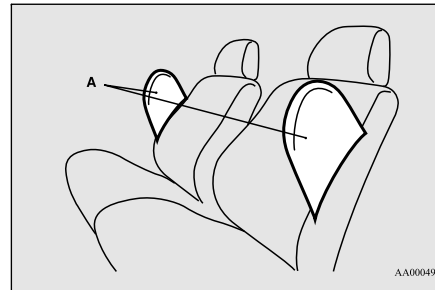

AA0004921

A label is attached to the seatbacks in vehicles equipped with side airbags.

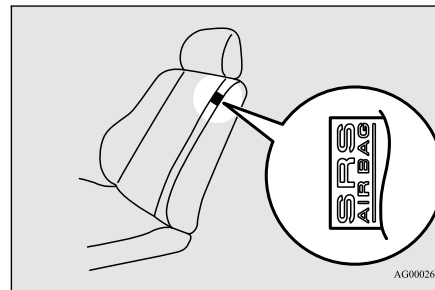

AG0002677

Curtain airbag system

N00419201328

Your vehicle is equipped with a curtain airbag in the front pillar, the rear pillar and the side sections of the roof.

The curtain airbag is designed to inflate only on the side of the vehicle that is impacted, even with no passenger in the seat.

Also, when the airbag control unit detects rollover of the vehicle, the curtain airbags will deploy.

4

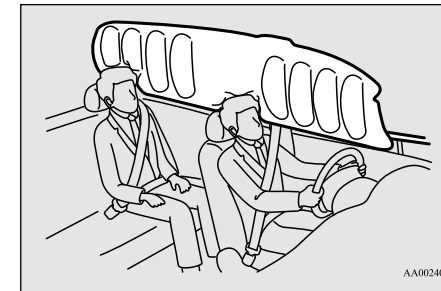

AA0024028

Supplemental Restraint System (SRS) - airbag

4

⚠ WARNING

- Side airbags and curtain airbags can cause serious injury or death to anyone too close to the airbag when it deploys. To reduce the risk of injury from a deploying side airbag or curtain airbag, driver and front passenger must be properly restrained and seated well back, upright, and in the middle of the seat. Do not lean against the door.



⚠ WARNING

- In order to reduce the risk of injury from a deploying side airbag, do not allow any rear seat passengers to hold onto the back of either front seat. Special care should be taken with children.

⚠ WARNING

- Do not place any objects around the area where the side airbags deploy. Such objects can interfere with proper side airbag deployment, and cause injury during deployment of the side airbag.
- Do not place stickers, labels or additional trim on the back of either front seat. They can interfere with proper side airbag deployment.
- Do not attach a microphone (A) or any other object around the part where the curtain airbag (B) deploys, such as on the windshield, side door glass or front and rear pillars and roof side rail. When the curtain airbag inflates, the microphone or other object may be hurled with great force or the curtain airbag may not inflate correctly, resulting in death or serious injury.

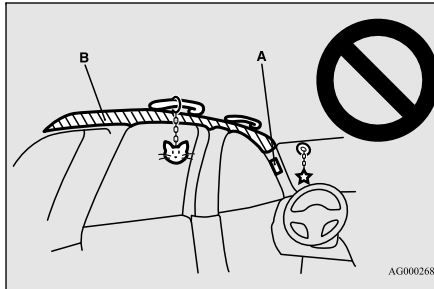

⚠ WARNING

- Do not put a hanger or any heavy or pointed object on the coat hook. If the curtain airbag was activated, any such item could be propelled away with great force and could prevent the curtain airbag from inflating correctly. Hang clothes directly on the coat hook (without using a hanger). Make sure there are no heavy or sharp objects in the pockets of clothes that you hang on the coat hook.
- Do not install seat covers or re-cover seats that have side airbags. Covers can interfere with proper side airbag deployment and adversely affect side airbag performance.
- Never install a rear-facing child restraint system in the front passenger seat. Rear-facing child restraint systems **MUST ONLY** be used in the rear seat.
- Front-facing child restraint systems should also be used **ONLY** in the rear seat. If a front-facing child restraint system must be used in the front passenger seat, move the seat as far back as possible, and make sure that the child stays in the child restraint system, properly restrained and away from the door.

Supplemental Restraint System (SRS) - airbag

⚠ WARNING

- Do not allow a child to lean against or sit close to the passenger door, even if the child is seated in a child restraint system. The child's head should also not lean against or be close to the section of the seatback where the side airbag and curtain airbag are located. It is dangerous if the side airbag or curtain airbag deploys. Failure to follow all of these instructions could lead to serious injury or death to the child.
- Work done on or in the vicinity of the side airbag or curtain airbag components should be done only by an authorized Mitsubishi Motors dealer. There is a risk of a serious injury or death. Improper work methods can cause accidental side airbag or curtain airbag deployment, or render a side airbag or curtain airbag inoperable. Either of these situations could result in serious injury or death.

Deployment of side airbag and curtain airbag

N00408200493

The side airbag and curtain airbag ARE DESIGNED TO DEPLOY when...

The side airbag and curtain airbag are designed to deploy when the vehicle suffers a moderate to severe side impact to the middle of the passenger compartment. The typical situation is shown in the illustration.

Moderate to severe impact to the middle of the vehicle body's side structure

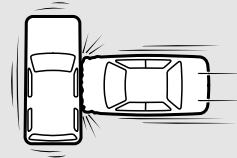

When the vehicle detects rollover of the vehicle (Curtain airbag only)

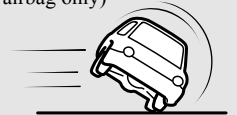

AG3000892

The seat belts in your vehicle are your primary means of protection in an accident. The SRS (Supplemental Restraint System) side airbags and curtain airbags are designed to provide additional protection. Therefore, for your safety and the safety of all occupants, be sure to always wear your seat belts properly.

4**The side airbag and curtain airbag MAY NOT DEPLOY when...**

In certain types of side collisions, the side airbag and curtain airbag may not deploy, even if the deformation of the body seems to be large, because the vehicle's body structure is designed to absorb the impact and to deform in order to help protect the occupants. There are also cases where the side airbag and curtain airbag may not deploy at the same time, depending on the location of the impact. Some typical situations where the side airbags and curtain airbags may not deploy are shown in the illustrations.

Because the side airbags and curtain airbags do not protect the occupant in all types of side collisions, be sure to always wear the seat belts properly.

Supplemental Restraint System (SRS) - airbag

4

Side impact in an area away from the passenger compartment

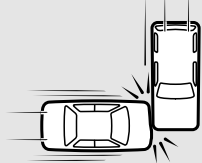

Motorcycle or other similar small vehicle collision with the side of vehicle



Collision with a utility pole, tree or other narrow object

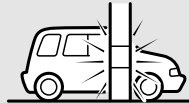

AA2000246

Oblique side impact



Vehicle rolls onto its side or roof (Side airbag only)



AA3000461

**The side airbag and curtain airbag
ARE NOT DESIGNED TO
DEPLOY when...**

The side airbag and curtain airbag are not designed to deploy in situations where they cannot provide protection to the occupants. Typical situations are shown in the illustration.

Because the side airbags and curtain airbags do not protect the occupant in all types of collisions, be sure to always wear your seat belts properly.

Head-on collision



Rear end collision to your vehicle



Pitch end over end

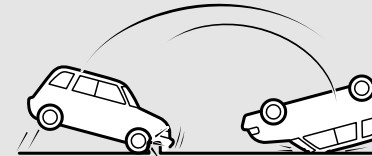

AG2000299

Supplemental Restraint System (SRS) - airbag

SRS servicing

N00408500698

WARNING

- Any maintenance performed on or near the components of the SRS should be performed only by an authorized Mitsubishi Motors dealer. Do not permit anyone else to do any service, inspection, maintenance or repair on any SRS components or wiring. Similarly, no part of the SRS should ever be handled, removed or disposed by anyone except an authorized Mitsubishi Motors dealer.

Improper work methods on the SRS components or wiring could result in an accidental airbag deployment or could make the SRS inoperable. Either of these situations could result in serious injury or death.

- Do not modify your steering wheel or any other SRS component or related vehicle part. For example, replacement of the steering wheel, or modifications to the front bumper or body structure can adversely affect SRS performance and may lead to injury.
- If your vehicle has received any damage, you should have the SRS inspected by an authorized Mitsubishi Motors dealer to make sure it is in proper working order.

WARNING

- Do not modify your front seats, center pillar or center console. Such modifications can adversely affect SRS performance and may lead to injury. Also, if you discover any tear or open seam in the seat fabric near the side airbag, have the seat inspected by an authorized Mitsubishi Motors dealer.
- If you have found any scratch, crack or damage to the portion of the front and rear pillars and roof side rail, you should have the SRS inspected by an authorized Mitsubishi Motors dealer.

NOTE

- When you transfer ownership of the vehicle to another person, we urge you to alert the new owner that it is equipped with the SRS and refer that owner to the applicable sections in this owner's manual.
- If you decide to junk or scrap your vehicle, we urge you to first take it to an authorized Mitsubishi Motors dealer so that the SRS can be made safe for disposal.
- If any of the following parts needs to be modified for use by a handicapped person, the advanced airbag system will be greatly affected. Please consult an authorized Mitsubishi Motors dealer.
 - Driver's seat
 - Front passenger seat
 - Front seat belt

NOTE

- Steering wheel
- Instrument panel

[For vehicles sold in U.S.A.]

To contact Mitsubishi Motors North America, Inc. call 1-888-648-7820 or write to:
Mitsubishi Motors North America, Inc.
Customer Relations Department
P.O. Box 6400
Cypress, CA 90630-0064

[For vehicles sold in Canada]

To contact Mitsubishi Motor Sales of Canada, Inc. call 1-888-576-4878 or write to:
Mitsubishi Motor Sales of Canada, Inc.
Customer Relations Department
P.O. Box 41009
4141 Dixie Road
Mississauga, ON L4W 5C9

[For vehicles sold in Puerto Rico]

To contact Mitsubishi Motor Sales of Caribbean, Inc. call 1-787-251-8715 or write to:
Mitsubishi Motor Sales of Caribbean, Inc.
Customer Service Department
P.O. Box 192216
SAN JUAN PR 00919-2216

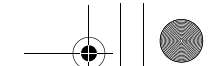

Supplemental Restraint System (SRS) - airbag

4

[For vehicles sold in Guam]

To contact Triple J Enterprises Inc.
call (671) 649-3673 or write to:

Triple J Enterprises, Inc.
P.O. Box 6066
TAMUNING
GUAM 96931

[For vehicles sold in Saipan]

To contact Triple J Motors
call (670) 234-7133 or write to:

Triple J Motors
P.O. Box 500487
SAIPAN, MP96950-0487

[For vehicles sold in American Samoa]

To contact Pacific Marketing Inc.
call 684 (699) 9140 or write to:

Pacific Marketing, Inc.
P.O. Box 698
PAGO PAGO,
AMERICAN SAMOA AS, 96799

Warning label

N00408600354

Occupant restraint warning labels for the SRS are located in the vehicle as shown in the illustration.

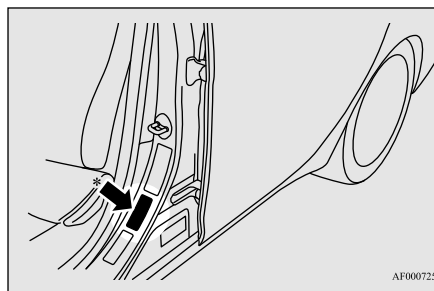
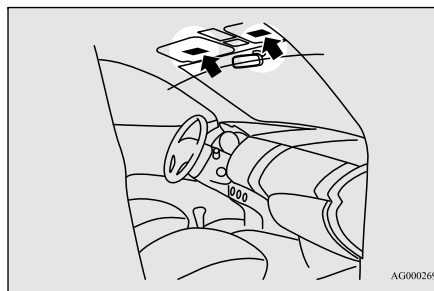

* - Located in the passenger's side as well.



Features and controls

Break-in recommendations	5-3	Brake assist system	5-67
Keys	5-3	Anti-lock braking system	5-67
Electronic immobilizer (Anti-theft starting system)	5-4	Electric power steering system (EPS)	5-69
Keyless entry system (if so equipped).....	5-7	Active stability control (ASC)	5-70
Free-hand Advanced Security Transmitter (F.A.S.T.-key) (if so equipped)	5-11	Cruise control (if so equipped)	5-73
Door locks	5-28	Forward Collision Mitigation system (FCM) (if so equipped)	5-78
Power door locks	5-30	Lane Departure Warning (LDW) (if so equipped)	5-86
Child safety locks for rear door	5-31	Tire pressure monitoring system	5-89
Liftgate	5-32	Rear-view camera	5-93
Inside liftgate release	5-33	Instrument cluster	5-95
Theft-alarm system	5-34	Multi-information display	5-97
Power window control	5-36	Indicator light, warning light, and information screen display list	5-118
Sunshade (if so equipped).....	5-39	Indicators	5-135
Parking brake	5-40	Warning lights	5-136
Steering wheel height and reach adjustment	5-41	Information screen display	5-137
Inside rearview mirror	5-42	Combination headlights and dimmer switch	5-139
Outside rearview mirrors	5-44	Headlight leveling switch (if so equipped).....	5-148
Ignition switch	5-46	Turn signal lever	5-149
Starting the engine	5-47	Hazard warning flasher switch	5-149
Manual transaxle (if so equipped)	5-49	Front fog light switch (if so equipped).....	5-150
Continuously variable transmission (CVT) (if so equipped).....	5-51	Wiper and washer switch	5-150
Electronically controlled 4WD system (if so equipped).....	5-58	Electric rear window defogger switch	5-155
4-wheel drive operation	5-60	Horn switch	5-156
Inspection and maintenance following rough road operation	5-63	Link System (if so equipped)	5-156
Cautions on the handling of 4-wheel drive vehicles	5-63	USB input terminal (if so equipped)	5-156
Service brake	5-64	Sun visors	5-158
Hill start assist	5-65	12 V power outlets	5-159

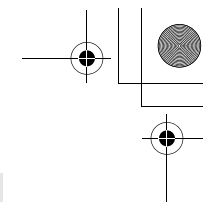

Features and controls

5

HomeLink® Wireless Control System (if so equipped).....	5-159
Interior lights	5-165
Storage spaces	5-168
Cup holders	5-170
Bottle holder	5-171
Cargo area cover (if so equipped)	5-171
Assist grips	5-172
Coat hook	5-172
Luggage hooks	5-173

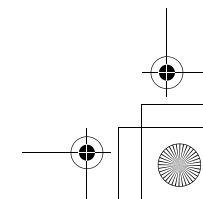
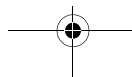
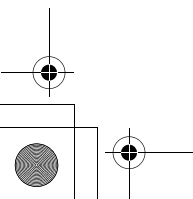
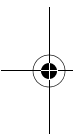

Break-in recommendations

N00508700330

Advanced automobile manufacturing techniques permit you to operate your new vehicle without requiring a long break-in period of low-speed driving.

However, you can add to the future performance and economy of your vehicle by observing the following precautions during the first 300 miles (500 km).

Drive your vehicle at moderate speeds during the break-in period.

- Avoid revving the engine.
- Avoid rough driving such as sudden starts, sudden acceleration, prolonged high-speed driving and sudden braking. These would have a detrimental effect on the engine and also cause increased fuel and oil consumption, which could result in malfunction of the engine components. Be particularly careful to avoid full acceleration while in low shift position (low gears).
- Do not overload the vehicle. Stay within the seating capacity. (Refer to “Cargo load precautions” on page 6-10.)
- Do not use this vehicle for trailer towing.

Keys

N00508801660

Type 1

Two keys are provided. The keys fit all locks. Keep one in a safe place as a spare key.

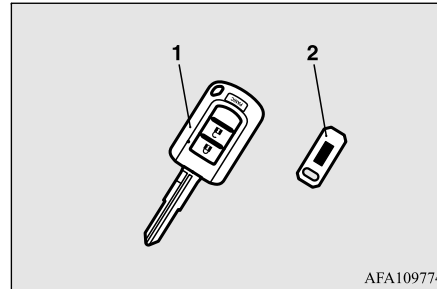

AFA109774

- 1- Key for the electronic immobilizer and keyless entry system
- 2- Key number plate

Type 2

Two F.A.S.T.-keys and two emergency keys are provided.

Keep one F.A.S.T.-key and one emergency key in a safe place together as a set of spare keys.

Break-in recommendations

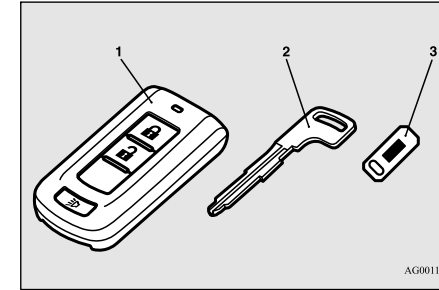

AG0011471

- 1- F.A.S.T.-key
(with electronic immobilizer and keyless entry system function)
- 2- Emergency key
- 3- Key number plate

5

NOTE

- The key is a precision electronic device with a built-in signal transmitter. Please observe the following in order to prevent damage.
 - Do not leave where it may be exposed to heat caused by direct sunlight, such as on top of the dashboard.
 - Do not take the remote control transmitter apart.
 - Do not excessively bend the key or subject it to strong impacts.
 - Keep the remote control transmitter dry.
 - Keep away from magnetic objects such as key rings.

Electronic immobilizer (Anti-theft starting system)

NOTE

- Keep away from devices that produce magnetism, such as audio systems, computers and televisions.
 - Keep away from devices that emit strong electromagnetic waves, such as cellular phones, wireless devices and high frequency equipment (including medical devices).
 - Do not clean with ultrasonic cleaners.
 - Do not leave the key where it may be exposed to high temperature or high humidity.
 - If you lose your key, to prevent the theft of the vehicle immediately contact an authorized Mitsubishi Motors dealer.
- If you notify an authorized Mitsubishi Motors dealer of the key number, they can make a new key. The key number is stamped on the key number plate. Keep the key number plate in a safe place separate from the key itself.
- No keys other than those registered in advance can be used to start the engine. Refer to “Electronic immobilizer (Anti-theft starting system)” on page 5-4. Refer to “Free-hand Advanced Security Transmitter (F.A.S.T.-key): “Electronic immobilizer (Anti-theft starting system)” on page 5-23.

NOTE

- When the theft-alarm is in the system operational status, the alarm operates if a door or liftgate is opened after using the key, the door lock knob or the power door lock switch to unlock the vehicle.
- The system does not enter the preparation status if the keyless entry system or the F.A.S.T.-key was not used to lock the vehicle.

Electronic immobilizer (Anti-theft starting system)

N00509101918

CAUTION

- Do not make any alterations or additions to the immobilizer system. Alterations or additions could cause failure of the immobilizer.

[For vehicles equipped with the Free-hand Advanced Security Transmitter (F.A.S.T.-key)]

For information on operations for vehicles equipped with the Free-hand Advanced Security Transmitter (F.A.S.T.-key), refer to “Free-hand Advanced Security Transmitter (F.A.S.T.-key): Electronic immobilizer (Anti-theft starting system)” on page 5-23.

[Except for vehicles equipped with the Free-hand Advanced Security Transmitter (F.A.S.T.-key)]

The electronic immobilizer is designed to significantly reduce the possibility of vehicle theft. The purpose of the system is to immobilize the vehicle if an invalid start is attempted. A valid start attempt can only be achieved (subject to certain conditions) using a key “registered” to the immobilizer system. All of the keys provided with your new vehicle have been programmed to the vehicle’s electronics.

NOTE

- In the following cases, the vehicle may not be able to recognize the registered ID code from the key. This means the engine will not start even when the key is turned to the “START” position.
- When the key contacts a key ring or other metallic or magnetic object



Electronic immobilizer (Anti-theft starting system)

NOTE

- When the key grip contacts metal of another key



- When the key contacts or is close to other immobilizer keys (including keys of other vehicles)



In cases like the above, move the offending object(s) away from the key and turn the key back to the “ACC” or “OFF” position. Then try to start the engine again. If the engine does not start, contact an authorized Mitsubishi Motors dealer.

- The key may not operate properly when it is near an object or facility that emits strong electromagnetic waves.

NOTE

- Electronic immobilizer is not compatible with commercially available remote starting systems. Use of commercially available remote starting systems may result in vehicle starting problems and a loss of security protection.
- A system failure is suspected when the ignition switch is turned to the “START” position, and the engine does not start. In such a case, contact an authorized Mitsubishi Motors dealer.

Replacement keys

Only keys that have been programmed to the vehicle’s electronics can be used to start the vehicle.

If you lose the key, you can order a key from your authorized Mitsubishi Motors dealer by referring to the key number.

To prevent vehicle theft, the ID code for the vehicle keys must be changed.

Take your vehicle and all remaining keys to your authorized Mitsubishi Motors dealer to have your ID code changed.

Additional keys

To add a key, you must already have 2 registered keys. You need to register the ID code to the vehicle.

Registering the ID code can be done by yourself (except for vehicles sold in Canada), or by your authorized Mitsubishi Motors dealer.

5

For you to register the ID code yourself, follow the “Customer key programming” procedure below.

If you choose to have your authorized Mitsubishi Motors dealer register the ID code, take your vehicle and all remaining keys to your authorized Mitsubishi Motors dealer.

NOTE

- You are provided with 2 keys, but you may register up to 8 keys.

Customer key programming (Except for vehicles sold in Canada)

N00562201181

You can program new keys to the system if you have two valid (already registered) keys and blank immobilizer key (specially cut for

Electronic immobilizer (Anti-theft starting system)

your vehicle at your Mitsubishi Motors dealer) by doing the following:

5

1. Insert the first valid key into the ignition switch and turn the key to the “ON” position for 5 seconds.
2. Turn the key to the “OFF” position and remove the first key.
3. Within 30 seconds of removing the first key, insert the second valid key into the ignition and turn it to the “ON” position. About 10 seconds later, the immobilizer display will start to blink.
4. When the immobilizer display starts blinking, turn the second valid key to the “OFF” position and remove it. Within 30 seconds after doing so, insert a blank immobilizer key into the ignition switch and turn it to the “ON” position. Perform this operation no more than 30 seconds after the immobilizer display starts blinking. When registration of the ID code is complete, the immobilizer display will come on for 30 seconds then go off. If an error occurs, the blinking immobilizer display will go off during the procedure.



5. If you wish to register another key, perform the process again from step 1.

5-6 Features and controls

NOTE

- Perform the operation when the interrupt display screen is not showing. The interrupt display screen may prevent you from seeing the immobilizer display.
- It is not possible to register a key if:
 - the immobilizer display goes off during the procedure
 - the immobilizer display does not come on within 30 seconds after step 4.
- The procedure will be terminated automatically if:
 - a period of 30 seconds or longer elapses from the moment when the first key is turned to the “OFF” position to the moment when the second key is turned to the “ON” position
 - a period of 30 seconds or longer elapses from the moment when the second key is turned to the “OFF” position to the moment when the blank immobilizer key is turned to the “ON” position
- To use the new remote control transmitters, it is necessary to register the key with both the electronic immobilizer and keyless entry system. Also refer to “Keyless entry system: Customer remote control transmitter programming” on page 5-9.

General information

N00562301111

Your electronic immobilizer operates on a radio frequency subject to Federal Communications Commission (FCC) Rules (For vehicles sold in U.S.A.) and Industry Canada Rules (For vehicles sold in Canada). This device complies with part 15 of FCC Rules and Industry Canada licence-exempt RSS standard(s).

Operation is subject to the following two conditions.

- This device may not cause harmful interference.
- This device must accept any interference received, including interference that may cause undesired operation.

CAUTION

- Changes or modifications not expressly approved by the manufacturer for compliance could void the user’s authority to operate the equipment.

Keyless entry system (if so equipped)

N00509001988

Press the remote control transmitter buttons to lock or unlock the doors and the liftgate. It can also help you signal for attention by setting off the panic alarm.

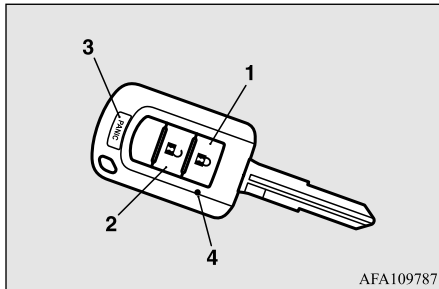

AFA109787

- 1- LOCK (🔒) button
- 2- UNLOCK (🔓) button
- 3- PANIC button
- 4- Indicator light

To lock

Press the LOCK button (1) to lock all the doors and the liftgate. The turn signal lights will also blink once.

NOTE

- If you press the LOCK button (1) twice the horn will sound once.

To unlock

Press the UNLOCK button (2) to unlock the driver's door only.

Within about 2 seconds, press the UNLOCK button one more time to unlock all the doors and liftgate.

The dome light will turn on for 30 seconds. The turn signal lights will also blink twice.

The front side-marker and parking lights will also turn on for about 30 seconds. Refer to "Welcome light" on page 5-147.

NOTE

- The door and liftgate unlock function can be set so that all doors and liftgate unlock when the UNLOCK button (2) is pressed once. Refer to "Setting the door and liftgate unlock function" on page 5-8.

Answerback function

The horn and turn signal lights of the keyless entry system answerback function can be

Keyless entry system (if so equipped)

changed as required. This is done with the key removed from the ignition switch.

NOTE

- The answerback function will not operate if any of the doors are open.

5

Horn deactivation/reactivation

The answerback function can be set in the following three ways.

Each time the answerback function is set, a chime will sound to tell you the condition of the answerback function.

- | | |
|--------------|--|
| One chime: | The horn will not sound. |
| Two chimes: | The horn will sound. |
| Four chimes: | The horn will sound if the LOCK button is pressed twice within 1 second. |

1. Remove the key from the ignition switch.
2. Open the driver's door and turn the combination headlights and dimmer switch to the "OFF" position.
3. Press and hold the LOCK button (1) for 4 to 10 seconds and then press and hold the UNLOCK button (2) during this time.

Keyless entry system (if so equipped)

4. Within 10 seconds of pressing the UNLOCK button in step 3, release the UNLOCK button first, and then release the LOCK button.

Turn signal lights deactivation/reactivation

5

The answerback function can be turned ON or OFF separately.

1. Remove the key from the ignition switch.
2. Open the driver's door and turn the combination headlights and dimmer switch to the "OFF" position.
3. Press and hold the UNLOCK button (2) for 4 to 10 seconds and then press and hold the LOCK button (1) during this time.
4. Within 10 seconds of pressing the LOCK button in step 3, release the UNLOCK button first, and then release the LOCK button.

Number of chimes	To lock	To unlock
One chime	One flash	Two flashes
Two chimes	One flash	No flash
Three chimes	No flash	Two flashes
Four chimes	Two flashes	One flash

Number of chimes	To lock	To unlock
Five chimes	No flash	One flash
Six chimes	Two flashes	No flash
Seven chimes	No flash	No flash

Setting the door and liftgate unlock function

N00543601128

The door and liftgate unlock function can be set to the following two conditions. Each time the door and liftgate unlock function is set, a chime will sound to tell you the condition of the door and liftgate unlock function.

Number of chimes	Condition
One chime	All doors and the liftgate unlock
Two chimes	Driver's door unlock only

1. Remove the key from the ignition switch.
2. Open the driver's door and turn the combination headlights and dimmer switch to the "OFF" position.

3. Press and hold the LOCK button (1) for 4 to 10 seconds and then press and hold the UNLOCK button (2) during this time.
4. Within 10 seconds of pressing the UNLOCK button in step 3, release the LOCK button first, and then release the UNLOCK button.

Using the panic alarm

N00543701073

If you are near your vehicle and feel threatened, you may activate the alarm to call attention as follows:

1. Press the PANIC button (3) for more than 1 second.
2. The headlights will blink on and off and the horn will sound intermittently for about 3 minutes.
3. To turn off the alarm, press any button on the remote control transmitter.

Replacement remote control transmitters

N00543800051

Only remote control transmitters programmed with the vehicle's electronics can lock or unlock all doors and the liftgate.

If you lose the remote control transmitter, you can order a remote control transmitter from

your authorized Mitsubishi Motors dealer by referring to the key number.

To prevent vehicle theft, the ID code for the remote control transmitter must be changed.

Take your vehicle and all remote control transmitters to your authorized Mitsubishi Motors dealer to have your ID code changed.

Additional remote control transmitters

N00543900049

To add a remote control transmitter, you must already have 1 registered remote control transmitter.

Registering the ID code can be done by yourself or by your authorized Mitsubishi Motors dealer. For you to register the ID code yourself, follow the “Customer remote control transmitter programming” procedure below.

If you choose to have your authorized Mitsubishi Motors dealer register the ID code, take your vehicle and any remaining keys to your authorized Mitsubishi Motors dealer.

NOTE

- You are provided with 2 remote control transmitters, but you may register up to 8 remote control transmitters.

Customer remote control transmitter programming (Except for vehicles sold in Canada)

N00544001187

You can program new remote control transmitters to the system if you have one valid (already registered) remote control transmitter by doing the following:

1. Have available all (current and new) remote control transmitters you wish to register.
2. With a valid (already registered) remote control transmitter, press and hold the UNLOCK button (2) for 4 to 10 seconds. Then press and hold the LOCK button (1) during this time.
3. Within 10 seconds of pressing the LOCK button, release the LOCK button first, and then release the UNLOCK button. At this time, ID codes for all remote control transmitters except for the transmitter used in steps 2 and 3 are erased and the answerback function (door is locked and unlocked) informs you that the registration mode has been activated.
4. Within 60 seconds after step 3, complete the following ID code registration operation using the next remote control transmitter you wish to register within 4 seconds.

Keyless entry system (if so equipped)

i) Press and hold both the LOCK and UNLOCK buttons for 2 seconds.

ii) Release both the LOCK and UNLOCK buttons simultaneously for 1 second.

iii) Press the UNLOCK button. The answerback function informs you that the ID code registration of the transmitter is completed.

5. To register the ID codes of additional remote control transmitters, repeat step 4 within 60 seconds after step 4.
6. If no ID code of a remote control transmitter is registered within 60 seconds after step 4, the registration mode is canceled and the normal mode returns.

NOTE

- For verification purposes, try to lock and unlock the doors with the re-coded remote control transmitters after the registration is completed.
- The indicator light (4) comes on each time a button is pressed.
- The keyless entry system does not work if the key is in the ignition switch.
- The remote control transmitter can be used from about 40 feet (12 m) away. However, this distance may change if your vehicle is near a TV transmitting tower, a power station, or a radio station.

Keyless entry system (if so equipped)

5

NOTE

- If the UNLOCK button (2) is pressed when all doors and the liftgate are locked and no doors or the liftgate are opened within about 30 seconds, the doors and the liftgate will automatically re-lock.
- If the following conditions are observed after pressing the LOCK (1) or UNLOCK (2) button on the remote control transmitter, the battery in the remote control transmitter may need to be replaced.
 - The doors and the liftgate cannot be locked or unlocked.
 - The panic alarm cannot be operated.
 - The indicator light (4) is dim or does not come on.
- If you lose your remote control transmitter, please contact an authorized Mitsubishi Motors dealer for a replacement.
- If you wish to obtain an additional remote control transmitter, please contact an authorized Mitsubishi Motors dealer. A maximum of 8 remote control transmitters can be programmed for your vehicle.
- To use the new remote control transmitters, it is necessary to register the key with both the electronic immobilizer and keyless entry system. Also refer to “Electronic immobilizer (Anti-theft starting system): Customer key programming” on page 5-5.

General information

N00546101137

Your keyless entry system operates on a radio frequency subject to Federal Communications Commission (FCC) Rules (For vehicles sold in U.S.A.) and Industry Canada Rules (For vehicles sold in Canada). This device complies with part 15 of FCC Rules and Industry Canada licence-exempt RSS standard(s). Operation is subject to the following two conditions.

- This device may not cause harmful interference.
- This device must accept any interference received, including interference that may cause undesired operation.

CAUTION

- Changes or modifications not expressly approved by the manufacturer for compliance could void the user's authority to operate the equipment.

Procedure for replacing the remote control transmitter battery

N00544101162

1. Before replacing the battery, remove static electricity from your body by touching a metal grounded object.
2. Remove the screw (A) from the remote control transmitter.

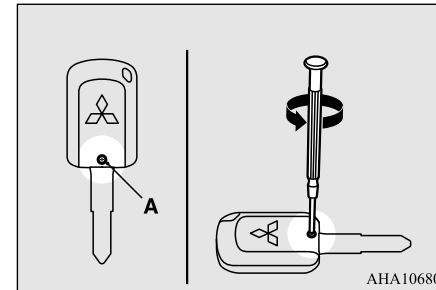

AHA106809

3. With the Mitsubishi mark facing you, insert the cloth-covered tip of a flat blade screwdriver into the notch in the remote control transmitter case and use it to open the case.

Free-hand Advanced Security Transmitter (F.A.S.T.-key) (if so equipped)

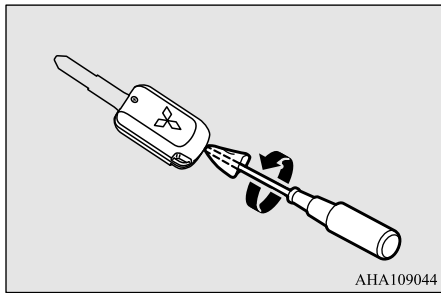

NOTE

- Be sure to perform the procedure with the Mitsubishi mark facing you. If the Mitsubishi mark is not facing you when you open the remote control transmitter case, the buttons may come out.
- The Federal Communications Commission (FCC) ID number, the Industry Canada (IC) number and the model number (radio certification) are indicated in the illustrated position.

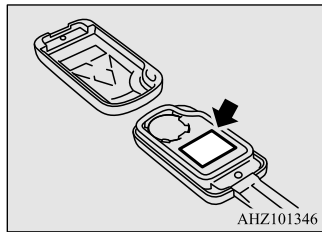

4. Remove the old battery.

5. Install a new battery with the + side (B) up.

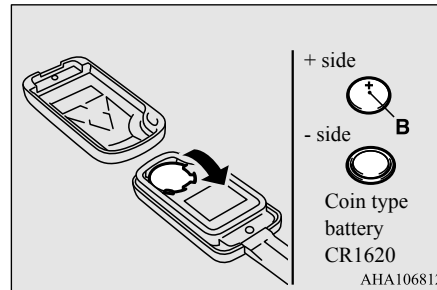

6. Close the remote control transmitter case firmly.
7. Attach the screw (A) removed in step 2.
8. Check the keyless entry system to see that it works.

NOTE

- You may purchase a replacement battery at an electric appliance store.
- An authorized Mitsubishi Motors dealer can replace the battery for you if you prefer.

CAUTION

- When the remote control transmitter case is opened, be careful to keep water, dust, etc. out. Also, do not touch the internal components.

Free-hand Advanced Security Transmitter (F.A.S.T.-key) (if so equipped)

N00503100111

5

The Free-hand Advanced Security Transmitter (F.A.S.T.-key) enables the doors and the liftgate to be locked and unlocked, the engine to be started and the operation mode to be changed simply by carrying it.

The F.A.S.T.-key can also be used as the remote control transmitter of the keyless entry system.

Refer to “Free-hand Advanced Security Transmitter (F.A.S.T.-key): Keyless entry system” on page 5-25.

The F.A.S.T.-key must be carried by the driver. The F.A.S.T.-key is required for vehicle operations such as locking and unlocking the doors and the liftgate, starting the engine, and changing the operation mode. When leaving the vehicle, make sure you are carrying the F.A.S.T.-key and then lock the vehicle.

Free-hand Advanced Security Transmitter (F.A.S.T.-key) (if so equipped)

5

⚠ WARNING

● Individuals who use implantable pacemakers or implantable cardiovascular-defibrillators should keep away from the external and internal transmitters. The electromagnetic waves used in the F.A.S.T.-key may affect the operation of implantable pacemakers and implantable cardiovascular-defibrillators.

⚠ WARNING

● Individuals using other electro-medical apparatus besides implantable pacemakers and implantable cardiovascular-defibrillators should check with the manufacturer of the apparatus to confirm the effect of the electromagnetic waves used by the F.A.S.T.-key. The electromagnetic waves may affect the operations of the electro-medical apparatus.

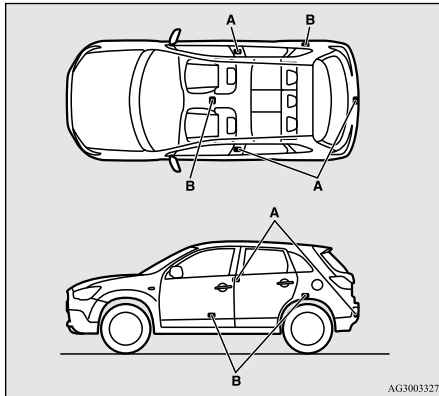

A- External transmitter
B- Internal transmitter

The operations possible with the F.A.S.T.-key can be modified as stated below. (Keyless entry operations are possible.) For details, contact an authorized Mitsubishi Motors dealer.

- Enabling only the locking and unlocking of the doors and the liftgate
- Enabling only the starting of the engine
- Deactivating the F.A.S.T.-key

📖 NOTE

- The F.A.S.T.-key uses weak electromagnetic waves. In cases such as the following, operation may be improper or unstable.
 - The vehicle is near a facility that emits strong electromagnetic waves, such as a TV transmitting tower, a power station, a radio station or an airport

📖 NOTE

- The key is carried together with other communication devices such as cellular phones or radios, or electrical appliances such as computers
 - The F.A.S.T.-key touches or is covered by a metal object
 - A keyless entry system is being used nearby
 - The battery of the F.A.S.T.-key is run down
 - The vehicle is in a location with strong electromagnetic waves or noise
- Use the emergency key in such circumstances.
- Refer to “To operate without using the F.A.S.T.-key” on page 5-22.
- The F.A.S.T.-key is constantly performing reception operations in its communication with the vehicle. This means that the battery is always running down, regardless of how often the F.A.S.T.-key is used. The battery life is about 1 to 3 years, depending on the usage conditions.
 - Since the F.A.S.T.-key is constantly performing reception operations, the reception of strong electromagnetic waves can accelerate the running down of the battery. Do not place near to electrical appliances such as televisions or computers.

Free-hand Advanced Security Transmitter (F.A.S.T.-key) (if so equipped)

Operating range of the F.A.S.T.-key

N00503201207

When a person enters the operating range of the F.A.S.T.-key while carrying the F.A.S.T.-key and presses the driver's or front passenger's door lock/unlock switch, the liftgate LOCK switch or the liftgate OPEN switch, verification of the ID code is performed.

The doors and the liftgate can only be locked and unlocked, the engine can only be started and the operation mode can only be changed when the ID codes of the vehicle and F.A.S.T.-key match.

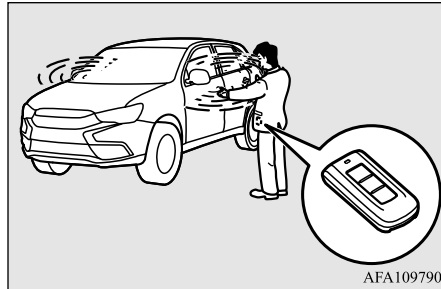

AFA109790

NOTE

- When the battery of the F.A.S.T.-key has run down or there are strong electromagnetic waves or noise in the area, the operating range could decrease or operations could become unstable.

Operating range for locking and unlocking the doors and the liftgate

The operating range is within about 2.3 feet (70 cm) of the driver's and front passenger's door lock/unlock switches, the liftgate LOCK switch and the liftgate OPEN switch.

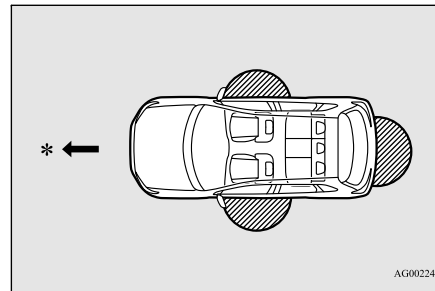

AG0022468

*: Front of the vehicle

: Operating range

NOTE

- Only the doors and the liftgate that detect the F.A.S.T.-key can be locked and unlocked.
- The system may not operate if the F.A.S.T.-key is too close to the windshield, door windows or liftgate.
- Even if the F.A.S.T.-key is within about 2.3 feet (70 cm) of the driver's or front passenger's door lock/unlock switch, the liftgate LOCK switch or the liftgate OPEN switch, the system may not operate if the key is close to the ground or in a high position.
- If the F.A.S.T.-key is within the operating range, even a person not carrying the F.A.S.T.-key can lock and unlock the doors or the liftgate by pressing the driver's or front passenger's door lock/unlock switch, the liftgate LOCK switch or the liftgate OPEN switch.

5

Operating range for starting the engine and changing the operation mode

N00503300067

The operating range is the interior of the vehicle.

Free-hand Advanced Security Transmitter (F.A.S.T.-key) (if so equipped)

5

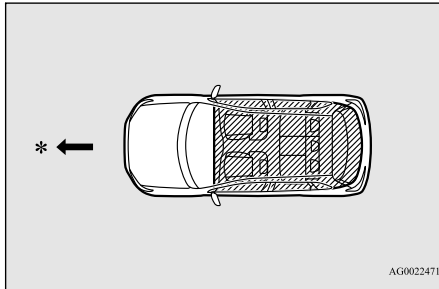

*: Front of the vehicle

: Operating range

NOTE

- Even if the F.A.S.T.-key is within the operating range, it may not be possible to start the engine and change the operation mode if the key is in a storage space such as the glove compartment, on top of the instrument panel, or in the door pocket or luggage compartment.
- Even if the F.A.S.T.-key is inside the vehicle, it may not be possible to start the engine and change the operation mode if the key is too close to a door or door window.

To operate using the F.A.S.T.-key

N00503401355

To lock

While carrying the F.A.S.T.-key, press the driver's or front passenger's door lock/unlock switch (A), or the liftgate LOCK switch (B) within the operating range to lock all the doors and the liftgate. The turn signal lights will blink once and the buzzer will sound once.

Also refer to "Doors locks", "Power door locks" and "Liftgate" on pages 5-28, 5-30 and 5-32 respectively.

Driver's and front passenger's door lock/unlock switches

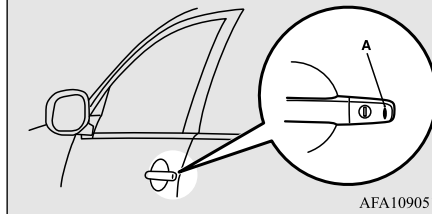

Liftgate switches

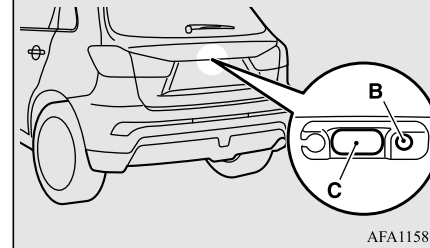

NOTE

- On vehicles equipped with the mirror retractor switch, the outside rearview mirrors will automatically retract when all doors and liftgate are locked using the driver's or front passenger's door lock/unlock switch (A) or the liftgate LOCK switch (B).
- In cases such as the following, the F.A.S.T.-key does not operate.
 - There is a F.A.S.T.-key in the passenger compartment
 - A door or the liftgate is open or ajar
 - The operation mode is not in OFF.
- The liftgate OPEN switch (C) can be used to confirm that the vehicle is locked properly. Press the liftgate OPEN switch within about 3 seconds of locking.
- If the liftgate OPEN switch is pressed 3 seconds or more after the vehicle is locked, the doors and the liftgate are unlocked.

Free-hand Advanced Security Transmitter (F.A.S.T.-key) (if so equipped)

NOTE

- The time within which locking confirmation is possible can be adjusted. See an authorized Mitsubishi Motors dealer for details.

To unlock

While carrying the F.A.S.T.-key within the operating range, you can unlock the doors and the liftgate by using the F.A.S.T.-key. The dome light will turn on for 30 seconds. The turn signal lights will blink twice and the buzzer will sound twice.

Also refer to “Door locks”, “Power door locks” and “Liftgate” on pages 5-28, 5-30 and 5-32 respectively.

Press the driver’s door lock/unlock switch (A) to unlock only the driver’s door. Within about 2 seconds, press the driver’s door lock/unlock switch one more time to unlock all the doors and the liftgate.

Driver’s door lock/unlock switch

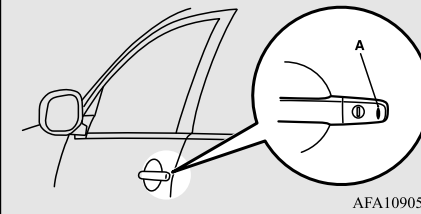

Front passenger’s door lock/unlock switch

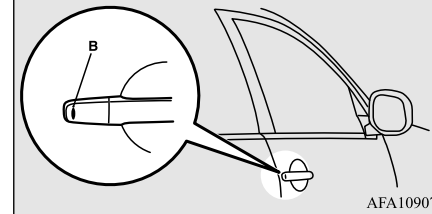

5

NOTE

- On vehicles equipped with the mirror retractor switch, the outside rearview mirrors will automatically extend when the driver’s door is unlocked using the driver’s lock/unlock switch (A), front passenger’s door lock/unlock switch (B) or the liftgate OPEN switch (C).
- Settings can be changed so that all doors and the liftgate are unlocked automatically by pressing the driver’s door lock/unlock switch once. Refer to “Setting the door and liftgate unlock function” on page 5-26.

Press the front passenger’s door lock/unlock switch (B) or the liftgate OPEN switch (C) to unlock all the doors and the liftgate.

Liftgate OPEN switch

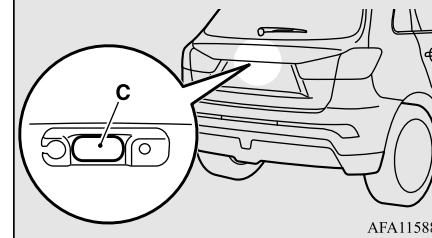

NOTE

- If the doors and the liftgate are unlocked using the driver’s or front passenger’s door lock/unlock switch when all doors and the liftgate are locked and no doors or the liftgate are opened within about 30 seconds, the doors and the liftgate will automatically re-lock.

Free-hand Advanced Security Transmitter (F.A.S.T.-key) (if so equipped)

NOTE

- The amount of time after unlocking until the vehicle relocks automatically can be adjusted. See an authorized Mitsubishi Motors dealer for details.
- The doors and the liftgate cannot be unlocked by using the liftgate OPEN switch for about 3 seconds after locking.
- The time within which locking confirmation is possible can be adjusted. See an authorized Mitsubishi Motors dealer for details.
- In cases such as the following, the F.A.S.T.-key does not operate.
 - A door or the liftgate is open or ajar
 - The operation mode is not in OFF.
- Functions settings can be modified as stated below.
See an authorized Mitsubishi Motors dealer for details.
 - Activating the operation confirmation function (blinking of the turn signal lights) only during locking, or only during unlocking.
 - Deactivating the operation confirmation function (blinking of the turn signal lights) and buzzer.
 - Modifying the number of blinks in the operation confirmation function (blinking of the turn signal lights).
 - Making the buzzer sound when the F.A.S.T.-key is removed from the passenger compartment when all the doors and the liftgate are closed.

5**Operation of the outside rear-view mirrors (Vehicles equipped with the mirror retractor switch)**

N00585700030

To retract

Within 30 seconds of locking the doors and liftgate using the LOCK switch, press the LOCK switch twice rapidly to retract the outside rearview mirrors.

To extend

Within 30 seconds of unlocking the doors and liftgate using the UNLOCK switch, press the UNLOCK switch twice rapidly to return the outside rearview mirrors to their extended positions.

The outside rearview mirrors are not initially set to work as described above. If you want them to work as described above, you need to set them so that they do not retract/extend when the doors and liftgate are locked/unlocked using the F.A.S.T.-key or the keyless entry system of the F.A.S.T.-key.

For details, please consult an authorized Mitsubishi Motors dealer.

NOTE

- On vehicles equipped with the mirror retractor switch, the outside rearview mirrors will automatically retract or extend when all the doors and liftgate are locked or unlocked using the remote control transmitter buttons or the F.A.S.T.-key.
Refer to “Features and controls: Outside rearview mirrors” on page 5-44.

Engine switch

N00513500075

To prevent vehicle theft, no F.A.S.T.-keys other than those registered in advance can be used to start the engine. (Electronic immobilizer function)

While carrying the F.A.S.T.-key, the engine switch can be used to start the engine.

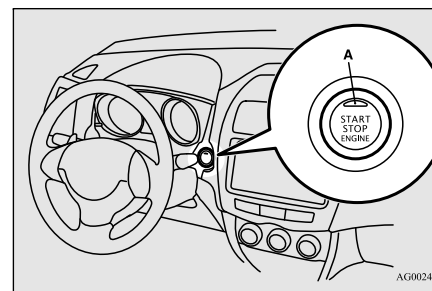

Free-hand Advanced Security Transmitter (F.A.S.T.-key) (if so equipped)

CAUTION

- The indicator light (A) will flash orange when there is a problem or malfunction in Free-hand Advanced Security Transmitter. Never drive if the indicator light on the engine switch is flashing orange. Immediately contact your authorized Mitsubishi Motors dealer.
- If the engine switch operation is not smooth and feels like it is sticking, do not operate the switch. Immediately contact an authorized Mitsubishi Motors dealer.

NOTE

- When operating the engine switch, press the switch all the way in. If the switch is not fully pressed, the engine may not start or the operation mode may not change. If the engine switch is pressed correctly, there is no need to hold the engine switch down.

Operation mode of the engine switch and its function

OFF

The indicator light on the engine switch turns off.
On vehicles equipped with continuously variable transmission (CVT), the operation mode

cannot be put in OFF when the selector lever is in any position other than the “P” (PARK) position.

ACC

Allows operation of electrical accessories. The indicator light on the engine switch illuminates orange.

ON

All electrical accessories can be used. The indicator light on the engine switch illuminates green. The indicator light turns off when the engine is running.

NOTE

- Your vehicle is equipped with an electronic immobilizer. To start the engine, the ID code which the F.A.S.T.-key sends must match the one registered to the immobilizer computer. (Refer to “Electronic immobilizer (Anti-theft starting system)” on page 5-23)

Changing the operation mode

N0056800025

If you press the engine switch without pressing the brake pedal {continuously variable transmission (CVT)} or the clutch pedal

(manual transaxle) while the vehicle is stationary, you can change the operation mode in the order of OFF, ACC, ON, OFF.

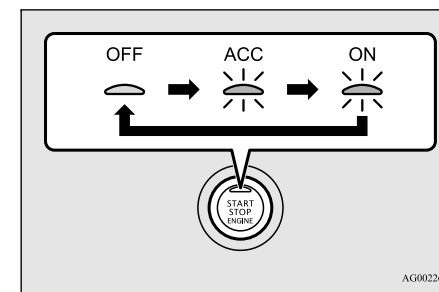

CAUTION

- When the engine is not running, put the operation mode in OFF. Leaving the operation mode in ON or ACC for a long time when the engine is not running may cause the battery to be discharged, making it impossible to start the engine.
- When the battery is disconnected, the current operation mode is memorized. After reconnecting the battery, the memorized mode is selected automatically. Before disconnecting the battery for repair or replacement, make sure to put the operation mode in OFF. Be careful if you are not sure which operation mode the vehicle is in when the battery is run down.

Free-hand Advanced Security Transmitter (F.A.S.T.-key) (if so equipped)

CAUTION

- The operation mode cannot be changed from OFF to ACC or ON if the F.A.S.T.-key is not detected to be in the vehicle. Refer to “Operating range for starting the engine and changing the operation mode” on page 5-13.

5 ACC power auto-cutout function

N00568101036

After approximately 30 minutes has elapsed with the operation mode in ACC, the function automatically cuts out the power for the audio system and other electric devices that can be operated with that mode.

When the engine switch is pressed while the operation mode is in ACC, the power is supplied again to those devices.

NOTE

- It is possible to modify functions as follows:
 - The time until the power cuts out can be changed to approximately 60 minutes.
 - The ACC power auto-cutout function can be deactivated.
- For details, we recommend you to consult an authorized Mitsubishi Motors dealer.



Warning activation

N00503500173

With the F.A.S.T.-key, warnings are given through buzzers and displays on the information screen in the multi-information display in order to prevent mistaken operations or vehicle theft.



When a warning operates, be sure to check the vehicle and the F.A.S.T.-key. A warning is also displayed if there is a problem in the F.A.S.T.-key.

If the following warning displays, contact an authorized Mitsubishi Motors dealer.



	There is a problem in the F.A.S.T.-key
	Put the operation mode in OFF and then start the engine again. If the warning is not cancelled, there is a fault in the electronic immobilizer (Anti-theft starting system). Please contact an authorized Mitsubishi Motors dealer.

If the following warnings display, the display goes off if the correct action is taken.

- The ID codes of the F.A.S.T.-key and the vehicle cannot be verified

	Someone may be carrying a F.A.S.T.-key with a different ID code, or the F.A.S.T.-key may not be within the operating range
	Refer to “F.A.S.T.-key take-out monitoring system” on page 5-19.
	The battery of the F.A.S.T.-key is run down

- A door or the liftgate cannot be locked even when the driver’s or front passenger’s door lock/unlock switch, or the liftgate LOCK switch is pressed.

	Refer to “Key lock-in prevention system” on page 5-19.
	Refer to “Door ajar prevention system” on page 5-19.
	Refer to “Operation mode OFF reminder system” on page 5-19.

Free-hand Advanced Security Transmitter (F.A.S.T.-key) (if so equipped)

F.A.S.T.-key take-out monitoring system

N00559801183



When the operation mode in any mode other than OFF, if the door(s) are opened, the F.A.S.T.-key is removed from the passenger compartment, and then the door(s) are closed, the warning display is displayed and the buzzer sounds 4 times as a warning since it's impossible to verify the ID codes of the F.A.S.T.-key and vehicle.

NOTE

- The F.A.S.T.-key take-out monitoring system does not function if the F.A.S.T.-key is removed through a window without opening a door.
This setting can be changed.
See an authorized Mitsubishi Motors dealer for details.

NOTE

- The warning may display even if the F.A.S.T.-key is in the operating range for starting the engine and changing the operation mode. The surrounding environment or electromagnetic waves may make it impossible to verify the ID codes of the F.A.S.T.-key and vehicle.

Key lock-in prevention system

N00559900116



When the operation mode is in OFF, the F.A.S.T.-key is left in the passenger compartment, all the doors and the liftgate are closed, and someone tries to lock the vehicle by pressing the driver's or front passenger's door lock/unlock switch, or the liftgate LOCK switch, the warning display is displayed and the buzzer sounds for about 3 seconds as a warning, and the doors and the liftgate cannot be locked.

Door ajar prevention system

N00560000117



5

When the operation mode is in OFF, and someone tries to lock the vehicle by pressing the driver's or front passenger's door lock/unlock switch, or the liftgate LOCK switch while one of the doors or the liftgate is not fully closed, the warning display is displayed and the buzzer sounds for about 3 seconds as a warning, and the doors and the liftgate cannot be locked.

Operation mode OFF reminder system

N00560100118



When the operation mode is in any mode other than OFF, all the doors and the liftgate are closed, and someone tries to lock the vehicle by pressing the driver's or front passenger's door lock/unlock switch, or the lift-

Free-hand Advanced Security Transmitter (F.A.S.T.-key) (if so equipped)

gate LOCK switch, the warning display is displayed and the buzzer sounds for about 3 seconds as a warning, and the doors and the liftgate cannot be locked.

Starting and stopping the engine

5

N00514601360

Tips for starting

- The operation mode can be in any mode to start the engine.
- The starter motor will be turning for up to approximately 15 seconds if the engine switch is released at once. Pressing the engine switch again while the starter motor is still turning will stop the starter motor. The starter motor will be turning for up to approximately 30 seconds while the engine switch is pressed. If the engine does not start, wait for a while and then attempt to start the engine again. Trying repeatedly with the starter motor still turning will damage the starter mechanism.
- If the engine will not start because the battery is weak or discharged, refer to “Jump-starting the engine” on page 8-2 for instructions.
- A longer warm up period will only consume extra fuel.

5-20 Features and controls

The engine is warmed up enough for driving when the bar graph of engine coolant temperature display starts to move. Refer to “Interrupt display screen (With ignition switch or operation mode in ON)” on page 5-106.

WARNING

- **Never run the engine in a closed or poorly ventilated area any longer than is needed to move your vehicle out of the area. Carbon monoxide gas, which is odorless and extremely poisonous, could build up and cause serious injury or death.**

CAUTION

- Do not push-start the vehicle.
- Do not run the engine at high rpms or drive at high speeds until the engine has had a chance to warm up.

Starting the engine

Your vehicle is equipped with an electronically controlled fuel injection system. This is a system that automatically controls fuel injection. There is usually no need to depress the accelerator pedal when starting the engine.

To prevent battery drain, wait a few seconds between attempts to restart the engine.

1. Make sure all occupants are properly seated with seat belts fastened.
2. Make sure the parking brake is applied.
3. Press and hold the brake pedal down firmly with your right foot.

NOTE

- After the engine has not started for a while, the brake pedal effort needed to start the engine may become greater. If this occurs, depress the brake pedal more firmly than usual.

4. Press and hold the clutch pedal all the way down (manual transaxle).
5. On vehicles equipped with manual transaxle, place the gearshift lever in the “N” (Neutral) position. On vehicles equipped with continuously variable transmission (CVT), make sure the selector lever is in the “P” (PARK) position.

Free-hand Advanced Security Transmitter (F.A.S.T.-key) (if so equipped)

NOTE

- On vehicles equipped with continuously variable transmission (CVT), the engine can only be started when the selector lever is in the “P” (PARK) or “N” (NEUTRAL) position. For safety reasons, the engine should be started when the selector lever is in the “P” (PARK) position in which the driving wheels lock.

6. Press the engine switch.
7. Confirm that all warning lights and warning displays are functioning properly.

NOTE

- Minor noises may be heard on engine start-up. These will disappear as the engine warms up.

When the engine is hard to start

After several attempts, you may experience that the engine still does not start.

1. Make sure that all electric devices, such as lights, air conditioning blower and rear window defogger, are turned off.

2. While depressing the brake pedal {continuously variable transmission (CVT)} or the clutch pedal (manual transaxle), press the accelerator pedal halfway and hold it there, then crank the engine. Release the accelerator pedal, immediately after the engine starts.
3. If the engine still will not start, the engine could be flooded with too much gasoline. While depressing the brake pedal (CVT) or the clutch pedal (manual transaxle), push the accelerator pedal all the way down and hold it there, then press the engine switch to crank the engine. If the engine does not start after 5 to 6 seconds, push the engine switch to stop cranking the engine, and release the accelerator pedal. Put the operation mode in OFF. Wait a few seconds, and then press the engine switch to crank the engine again while depressing the brake pedal (CVT) or the clutch pedal (manual transaxle), but do not push the accelerator pedal. If the engine fails to start, repeat these procedures. If the engine still will not start, contact your local Mitsubishi Motors dealer or a repair facility of your choice for assistance.

Startability of continuously variable transmission (CVT) vehicles with an ambient temperature of -22 °F (-30 °C) or lower

When the ambient temperature is -22 °F (-30 °C) or lower, it may not be possible to start from a standstill even with the selector lever in the “D” (DRIVE) or “R” (REVERSE) position.

This phenomenon occurs because the transaxle has not warmed up sufficiently; it does not indicate a problem. If this occurs, place the selector lever in the “P” (PARK) position and let the engine idle for at least 10 minutes. The transaxle will warm up, and you will be able to start normally.

Do not leave the vehicle during warm-up operation.

Stopping the engine

N00568200014

WARNING

- Do not operate the engine switch while driving except in an emergency. If the engine is stopped while driving, the brake servomechanism will cease to function and braking efficiency will deteriorate. Also, the power steering system will not function and it will require greater manual effort to operate the steering. This could result in a serious accident.

Free-hand Advanced Security Transmitter (F.A.S.T.-key) (if so equipped)

5

NOTE

- If you have to bring the engine to an emergency stop while driving, press and hold the engine switch for 3 seconds or more, or press it quickly 3 times or more. The engine will stop and the operation mode will go to ACC.
- On vehicles equipped with continuously variable transmission (CVT), do not stop the engine with the selector lever in any position other than the “P” (PARK) position. If the engine is stopped with the selector lever in any position other than the “P” (PARK) position, the operation mode will go to ACC rather than OFF.
Put the operation mode in OFF after placing the selector lever in the “P” (PARK) position.

1. Stop the vehicle.
2. Fully engage the parking brake while depressing the brake pedal.
3. On vehicles with a manual transaxle, press the engine switch to stop the engine, and then move the gearshift lever to the 1st (on a uphill) or “R” (Reverse) (on a downhill) position.
On vehicles equipped with continuously variable transmission (CVT), move the selector lever to the “P” (PARK) position, and then press the engine switch to stop the engine.

If the F.A.S.T.-key is not operating properly

N00568301067

Insert the F.A.S.T.-key into the key slot in the glove box. Starting the engine and changing the operation mode should be now possible. Remove the F.A.S.T.-key from the key slot after starting the engine or changing the operation mode.

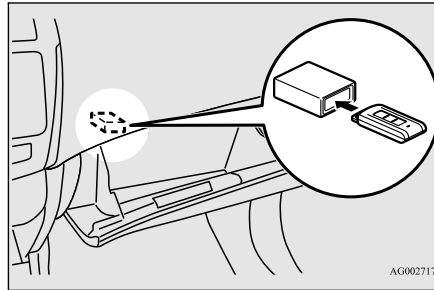
**NOTE**

- Do not insert into the key slot anything other than the F.A.S.T.-key. This could cause damage or a malfunction.
- Remove the object or additional key from the F.A.S.T.-key before inserting the key into the key slot. The vehicle may not be able to receive the registered ID code from the registered key. Therefore, the engine may not start and the operation mode may not change.

NOTE

- The F.A.S.T.-key is fixed in the key slot when inserted in the illustrated direction. Simply pull out the key to remove it from the key slot.

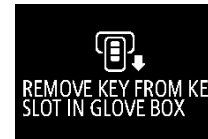
F.A.S.T.-key reminder

If the operation mode is in OFF and the driver's door is opened with the F.A.S.T.-key in the key slot, a warning is issued with the warning display and the buzzer buzzing for approximately 3 seconds to remind you to remove the key.

To operate without using the F.A.S.T.-key

N00514800017

Emergency key

N00515200106

The emergency key is built into the F.A.S.T.-key.

When the F.A.S.T.-key cannot be used, such as when the battery of the F.A.S.T.-key or the

Free-hand Advanced Security Transmitter (F.A.S.T.-key) (if so equipped)

vehicle has run down, the emergency key can be used to lock and unlock the driver's door.

To use the emergency key (A), unlock the lock knob (B) and remove it from the F.A.S.T.-key (C).

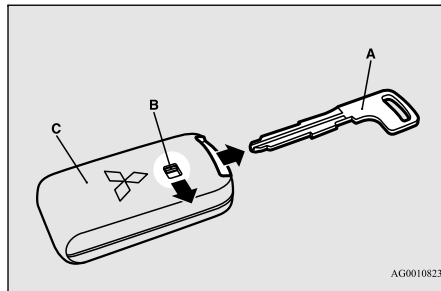

NOTE

- Only use the emergency key in an emergency. When the battery of the F.A.S.T.-key has run down, replace the battery as soon as possible and use it as a F.A.S.T.-key again.
- After using the emergency key, be sure to reinsert it into the F.A.S.T.-key.

Locking and unlocking the driver's door

Turn the emergency key toward the front of the vehicle to lock the door. After checking that the door is locked, turn the emergency key back to the center and remove it.

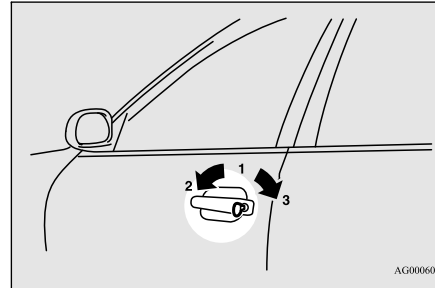

- 1- Insert or remove the emergency key
- 2- Lock
- 3- Unlock

Electronic immobilizer (Anti-theft starting system)

N00529601153

The electronic immobilizer is designed to significantly reduce the possibility of vehicle theft. The purpose of the system is to immobilize the vehicle if an invalid start is attempted. A valid start attempt can only be achieved (subject to certain conditions) using a F.A.S.T.-Key "registered" to the immobilizer system.

All of the keys provided with your new vehicle have been programmed to the vehicle's electronics.

NOTE

- If the engine does not start, contact an authorized Mitsubishi Motors dealer.

Replacement F.A.S.T.-keys

N0056100042

5

Only the F.A.S.T.-keys that have been programmed to the vehicle's electronics can be used to start the vehicle.

If you lose the F.A.S.T.-key, you can order a F.A.S.T.-key from your authorized Mitsubishi Motors dealer by referring to the key number. To prevent vehicle theft, take your vehicle and the remaining F.A.S.T.-keys to an authorized Mitsubishi Motors dealer to have the ID codes reprogrammed.

Additional F.A.S.T.-keys

N00561100014

To add a F.A.S.T.-key, you must already have 2 registered F.A.S.T.-keys. You need to register the ID code to the vehicle.

Registering the ID code can be done by your authorized Mitsubishi Motors dealer. Or it can be done by yourself (except for vehicles sold in Canada).

For you to register the ID code yourself, follow the "Customer F.A.S.T.-key programming" procedure below.

Free-hand Advanced Security Transmitter (F.A.S.T.-key) (if so equipped)

If you choose to have your authorized Mitsubishi Motors dealer register the ID code, take your vehicle and all remaining F.A.S.T.-keys to your authorized Mitsubishi Motors dealer.

5

NOTE

- You are provided with 2 F.A.S.T.-keys, but you may register up to 4 F.A.S.T.-keys. You can obtain blank F.A.S.T.-keys specially cut for your vehicle from your Mitsubishi Motors dealer.

Customer F.A.S.T.-key programming (Except for vehicles sold in Canada)

N00561201184

You can program new F.A.S.T.-keys to the system if you have two valid (already registered) F.A.S.T.-keys and blank (not registered) F.A.S.T.-key.

For F.A.S.T.-key programming, follow the procedures below.

1. Open the driver's door.

NOTE

- Keep the driver's door open until F.A.S.T.-key programming is finished. Do not open or close other doors.

2. While carrying the first valid F.A.S.T.-key, put the operation mode in ON. (Perform the following procedure within 30 seconds.)
3. Insert the new F.A.S.T.-key into the key slot.

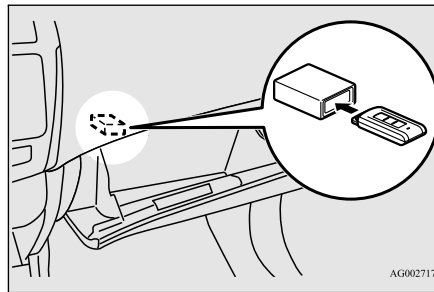

4. With the first valid F.A.S.T.-key, press and hold the UNLOCK button for 4 to 10 seconds and then press and hold the LOCK button during this time.
5. Within 10 seconds of pressing the LOCK button in step 4, release the LOCK button first, and then release the UNLOCK button. (Perform the following procedure within 30 seconds.)
6. With the second valid F.A.S.T.-key, press and hold the UNLOCK button for 4 to 10 seconds and then press and hold the LOCK button during this time.

7. Within 10 seconds of pressing the LOCK button in step 6, release the LOCK button first, and then release the UNLOCK button. The immobilizer display on the information screen in the multi-information display will blink.



When registration of ID code is complete, the buzzer will sound 3 times and the immobilizer display will come on for 30 seconds.

If an error occurs, F.A.S.T.-key programming will be terminated and the buzzer will sound for 3 seconds.

NOTE

- F.A.S.T.-key programming will be terminated if the operation mode is put in OFF before the immobilizer display starts blinking.

8. If you wish to register another F.A.S.T.-key, repeat the process from step 1 after the operation mode is put in OFF.

Free-hand Advanced Security Transmitter (F.A.S.T.-key) (if so equipped)

NOTE

- The immobilizer display will go off immediately if the operation mode is put in OFF.
- Perform the operation when the interrupt display screen is not showing. The interrupt display screen may prevent you from seeing the immobilizer display.
- It is not possible to register a F.A.S.T.-key if the immobilizer display goes off during the procedure.



Keyless entry system

N00515501252

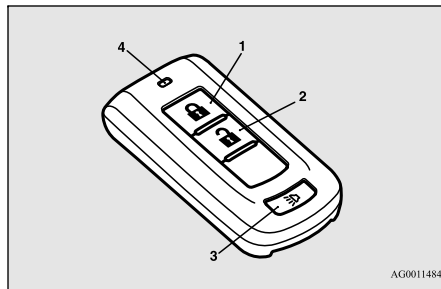
Press the remote control transmitter buttons to lock or unlock the doors and the liftgate. It can also help you signal for attention by setting off the panic alarm.



AG0011484

- 1- LOCK  button
- 2- UNLOCK  button

- 3- PANIC button
- 4- Operation indicator light

NOTE

- On vehicles equipped with the mirror retractor switch, the outside rearview mirrors will automatically retract or extend when the doors and the liftgate are locked or unlocked using the remote control transmitter buttons. Refer to “Features and controls: Outside rearview mirrors” on page 5-44.

To lock

Press the LOCK button (1) to lock all the doors and the liftgate. The turn signal lights will also blink once.

NOTE

- On vehicles equipped with the mirror retractor switch, the outside rearview mirrors will automatically retract when the LOCK button (1) is pressed.
- If you press the LOCK button (1) twice, the horn will sound once.

To unlock

Press the UNLOCK button (2) to unlock the driver’s door only.

To unlock all doors and the liftgate, press the UNLOCK button two times within a 2 second time period.

The dome light will turn on for 30 seconds. The turn signal lights will also blink twice. The front side-marker and parking lights will also turn on for about 30 seconds. Refer to “Welcome light” on page 5-147.

5

NOTE

- On vehicles equipped with the mirror retractor switch, the outside rearview mirrors will automatically extend when the UNLOCK button (2) is pressed.
- The door and liftgate unlock function can be set so that all doors and the liftgate unlock when the UNLOCK button (2) is pressed once. Refer to “Setting the door and liftgate unlock function” on page 5-26.

Answerback function

The horn and turn signal lights of the keyless entry system answerback function can be changed as required.

Horn deactivation/reactivation

The answerback function can be set in the following three ways.

Free-hand Advanced Security Transmitter (F.A.S.T.-key) (if so equipped)

- One chime: The horn will not sound.
- Two chimes: The horn will sound.
- Four chimes: The horn will sound if the LOCK button is pressed twice within 1 second.

5

1. Put the operation mode in OFF.
2. Open the driver's door and turn the combination headlights and dimmer switch to the "OFF" position.
3. Press and hold the LOCK button (1) for 4 to 10 seconds and then press and hold the UNLOCK button (2) during this time.
4. Within 10 seconds of pressing the UNLOCK button in step 3, release the UNLOCK button first, and then release the LOCK button.

Turn signal light deactivation/reactivation

The answerback function from the turn signal lights can be turned ON or OFF separately.

1. Put the operation mode in OFF.
2. Open the driver's door and turn the combination headlights and dimmer switch to the "OFF" position.

3. Press and hold the UNLOCK button (2) for 4 to 10 seconds and then press and hold the LOCK button (1) during this time.
4. Within 10 seconds of pressing the LOCK button in step 3, release the UNLOCK button first, and then release the LOCK button.

Number of chimes	To lock	To unlock
One chime	One flash	Two flashes
Two chimes	One flash	No flash
Three chimes	No flash	Two flashes
Four chimes	Two flashes	One flash
Five chimes	No flash	One flash
Six chimes	Two flashes	No flash
Seven chimes	No flash	No flash

Buzzer deactivation/reactivation

The buzzer answerback function can be turned ON or OFF as required.

Setting the door and liftgate unlock function

N00544601109

The door and liftgate unlock function can be set to the following two conditions. Each time the door and liftgate unlock function is set, a chime will sound to tell you the condition of the door and liftgate unlock function.

Number of chimes	Condition
One chime	All doors and the liftgate unlock
Two chimes	Driver's door unlock only

1. Put the operation mode in OFF.
2. Open the driver's door and turn the combination headlights and dimmer switch to the "OFF" position.
3. Press and hold the LOCK button (1) for 4 to 10 seconds and then press and hold the UNLOCK button (2) during this time.
4. Within 10 seconds of pressing the UNLOCK button in step 3, release the LOCK button first, and then release the UNLOCK button.

Free-hand Advanced Security Transmitter (F.A.S.T.-key) (if so equipped)

Using the panic alarm

N00544701083

If you are near your vehicle and feel threatened, you can activate the alarm to call attention as follows:

1. Press the PANIC button (3) for more than 1 second.
2. The headlights will blink on and off and the horn will sound intermittently for about 3 minutes.
3. To turn off the alarm, press any button on the remote control transmitter.

NOTE

- The indicator light (4) comes on each time a button is pressed.
- The F.A.S.T.-key can be used from about 40 feet (12 m) away. However, this distance may change if your vehicle is near a TV transmitting tower, a power station, or a radio station.
- If the UNLOCK button (2) is pressed when all doors and the liftgate are locked and no doors or the liftgate are opened within about 30 seconds, the doors and the liftgate will automatically re-lock.
- If the following conditions are observed after pressing the LOCK (1) or UNLOCK (2) button on the remote control transmitter, the battery in the F.A.S.T.-key may need to be replaced.

NOTE

- The doors and the liftgate cannot be locked or unlocked.
- The panic alarm cannot be operated.
- The indicator light (4) is dim or does not come on.
- If you lose your F.A.S.T.-key, please contact an authorized Mitsubishi Motors dealer for a replacement.
- If you wish to obtain an additional F.A.S.T.-key, please contact an authorized Mitsubishi Motors dealer. A maximum of four F.A.S.T.-key can be programmed for your vehicle.
- To use the new remote control transmitters, it is necessary to register the key with the electronic immobilizer and keyless entry system. Refer to "Electronic immobilizer (Anti-theft starting system): Customer F.A.S.T.-key programming" on page 5-24.

General information

N00562001088

Your F.A.S.T.-key operates on a radio frequency subject to Federal Communications Commission (FCC) Rules (For vehicles sold in U.S.A.) and Industry Canada Rules (For vehicles sold in Canada). This device complies with part 15 of FCC Rules and Industry Canada licence-exempt RSS standard(s). Operation is subject to the following two conditions.

- This device may not cause harmful interference.
- This device must accept any interference received, including interference that may cause undesired operation.

CAUTION

- Changes or modifications not expressly approved by the manufacturer for compliance could void the user's authority to operate the equipment.

5**Procedure for replacing the remote control transmitter battery**

N00562100066

1. Before replacing the battery, remove static electricity from your body by touching a metal grounded object.
2. With the Mitsubishi mark facing you, insert the cloth-covered tip of a flat blade screwdriver into the notch in the case and use it to open the case.

Door locks

5

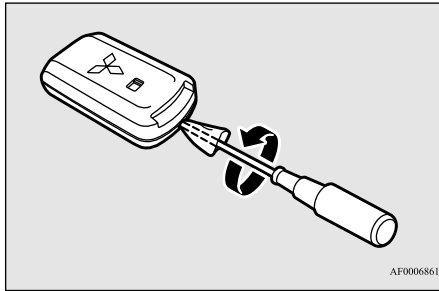

NOTE

- Be sure to perform the procedure with the Mitsubishi mark facing you. If the Mitsubishi mark is not facing you when you open the case, the transmitter may come out.

3. Remove the old battery.
4. Install a new battery with the + side (A) up.

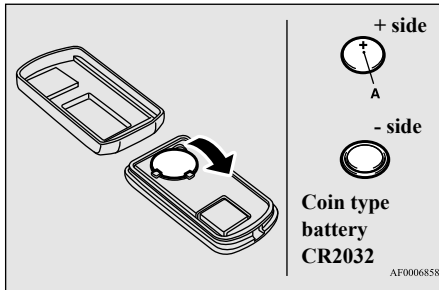

5. Close the case firmly.
6. Check the keyless entry system to see that it works.

NOTE

- You may purchase a replacement battery at an electric appliance store.
- An authorized Mitsubishi Motors dealer can replace the battery for you if you prefer.

CAUTION

- When the remote control transmitter case is opened, be careful to keep water, dust, etc. out. Also, do not touch the internal components.

Door locks

N00509200488

WARNING

- Make sure all doors are tightly closed and locked while driving.
- Locked doors, in combination with the use of seat belts, can help reduce the risk of ejection in an accident.
- Locked doors can help keep passengers, especially small children, from opening doors and falling out of moving vehicles.
- Locked doors can help prevent outsiders from gaining access to your vehicle when you slow or come to a stop.

WARNING

- Lock your vehicle whenever you leave it. Children who get into unlocked vehicles may not be able to get out. Children trapped inside vehicles can quickly be overcome by heat and suffer serious injury or death due to heat stroke.
- Never leave a child alone in the vehicle. In addition to the risk of heat stroke, children can activate switches and controls, resulting in an injury or fatal accident.
- When closing a door, make sure that the door is fully closed and the door-ajar warning display goes out on the information screen on the multi-information display. If the door is ajar it could open while driving and cause an accident.

To lock and unlock with the key (driver's door)

Turn the key toward the front of the vehicle to lock the door. After checking that the door is locked, turn the key back to the center and remove it.

Door locks

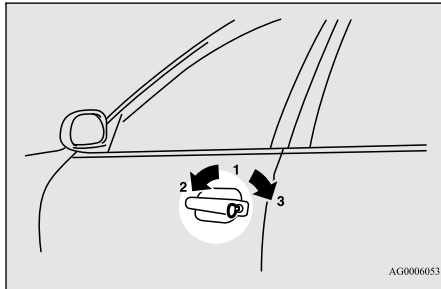

- 1- Insert or remove the key
- 2- Lock
- 3- Unlock

NOTE

- When locking or unlocking with the key, only the driver's door will be locked or unlocked.
To lock or unlock all doors and the liftgate, use the power door lock switches, the keyless entry system or the F.A.S.T.-key operation.
Refer to "Power door locks" on page 5-30, "Keyless entry system" on pages 5-7 and 5-25, and "To operate using the F.A.S.T.-key" on page 5-14.
- In vehicles equipped with the F.A.S.T.-key, the driver's door can be locked and unlocked using the emergency key.
Refer to "Emergency key" on page 5-22.

To lock or unlock the door from the inside

Move the lock knob to the lock position to lock the door.
All doors should be kept locked while driving.

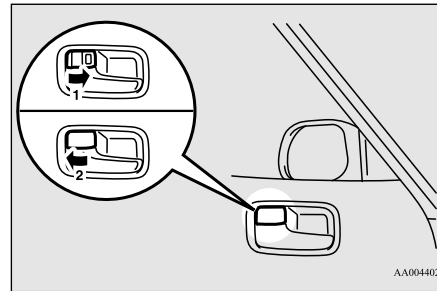

- 1- Lock
- 2- Unlock

The driver's door can be unlocked without using the lock knob by pulling on the inside door handle.

To lock the door without using the key

1. Move the inside lock knob to the locked position.

2. Be sure the keys are not inside the vehicle. Close the door.

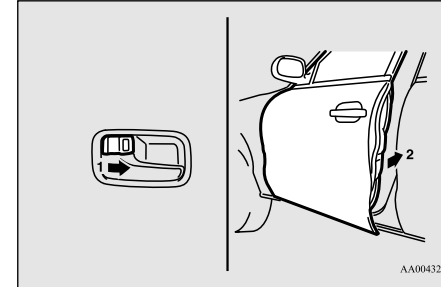

5

Key reminder system (except for vehicles equipped with the F.A.S.T.-key)

N00549600224

Type 1



Type 2

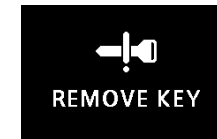

Power door locks

If the ignition switch is turned off and the driver's door is opened with the key in the ignition switch, the key reminder buzzer will sound intermittently to remind you to remove the key.

The warning display will be displayed on the information screen in the multi-information display.

5

Lock out protection

N0051730042

If the key is in the ignition switch or the operation mode is in any mode other than OFF when you push the lock knob forward with the driver's door or passenger's door open, the lock knob will automatically return to the unlocked position.

Operation mode ON reminder system (vehicles equipped with the F.A.S.T.-key)

N00503800105



If the driver's door is opened while the engine is stopped and the operation mode is in any position other than OFF, the operation mode

ON buzzer will sound intermittently to remind you to put the operation mode in OFF. The warning display will be displayed on the information screen in the multi-information display.

Power door locks

N00509300551

NOTE

- When locking or unlocking with the key on the driver's door, only the driver's door will lock or unlock.
- Repeated continuous operation between lock and unlock could activate the power door locking system's built-in protection circuit, and prevent the system from operating. If this occurs, wait about 1 minute before operating the power door lock switch.

To lock and unlock the doors and liftgate

Using the power door lock switch

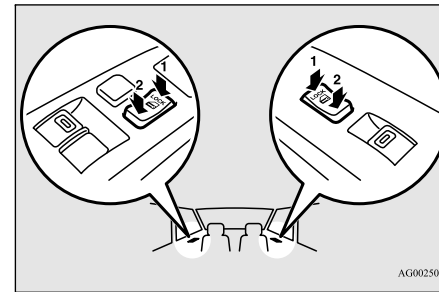

- 1- Lock
- 2- Unlock

All of the doors and the liftgate can be locked or unlocked by pressing the power door lock switch on the driver's or the front passenger door.

To unlock the doors and liftgate

N00563401223

You can select the functions to unlock the doors and liftgate either using the ignition switch or the engine switch, or using the selector lever position {continuously variable transmission (CVT)}.

These functions are not activated when the vehicle is shipped from the factory. To activate or deactivate these functions, please contact your authorized Mitsubishi Motors dealer.

Using the ignition switch or the engine switch

All doors and the liftgate will unlock when the ignition switch is turned to the “OFF” position or the operation mode is put in OFF.

Using the selector lever position {continuously variable transmission (CVT)}

All doors and the liftgate will unlock when the selector lever is moved to the “P” (PARK) position with the ignition switch or the operation mode in ON.

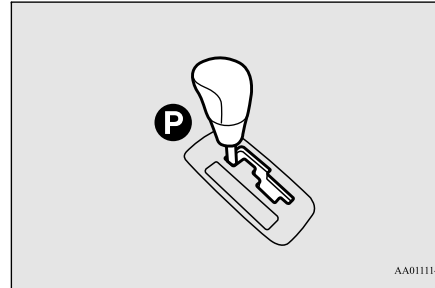

AA0111142

Child safety locks for rear door

N00509400262

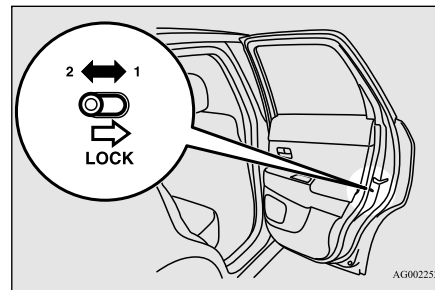

AG0022527

- 1- To lock
- 2- To release

Child safety locks for rear door

Child safety locks help prevent rear passengers, especially children, from opening the rear door using the inside door handle.

A lock lever for the child safety lock is provided on each rear door.

When the lever is in the lock position (1), the rear door cannot be opened using the inside door handle.

To open the rear door when the child safety lock lever is in the lock position, pull the outside door handle.

When the lever is in the release position (2), the child safety lock is released and the rear door can be opened using the inside door handle.

5

! WARNING

- Always keep the doors tightly closed and locked when driving. An unlocked door may be accidentally opened by a passenger, especially by a child who could fall out. Also, if the doors are not locked, there is a greater risk of someone being thrown from the vehicle in an accident.

Liftgate

Liftgate

N00510101338

⚠ WARNING

- The luggage compartment was not designed for people to ride in it. Do not let passengers ride in or let children play in the luggage compartment. Riding or playing in the luggage compartment could result in a serious accident or injury.
- Before driving, be sure that the liftgate is securely closed. It is dangerous to drive with the liftgate open since carbon monoxide (CO) gas contained in engine exhaust gases can enter the passenger compartment.
CO is an invisible, odorless gas that can cause unconsciousness and even death. In addition, if the liftgate opens while driving, luggage could fall onto the road and cause an accident.
- When opening and closing the liftgate, make sure that there are no people nearby and that there is sufficient space behind and above the vehicle. In addition, be careful not to hit your head or pinch your hands, neck, etc.
- If snow or ice has accumulated on the liftgate, remove it before opening the liftgate. Otherwise the liftgate may abruptly close due to the weight of the snow or ice.
- When opening the liftgate, always fully open it. A partially opened liftgate can unexpectedly close due to its own weight.

5

⚠ WARNING

- When the vehicle is parked on a slope, the effort required to open or close the liftgate may be greater or less than expected. The liftgate may also open or close more quickly.

⚠ CAUTION

- Do not stand behind the exhaust pipe when loading and unloading luggage. Heat from the exhaust could lead to burns.
- To avoid damage to the liftgate, make sure the area above and behind the liftgate is clear before opening it.

📖 NOTE

- Locking and unlocking the doors by using power door locks (driver and front passenger side), keyless entry system or the F.A.S.T.-key operation (vehicles equipped with the F.A.S.T.-key) also locks and unlocks the liftgate.

To open

After unlocking, press the liftgate OPEN switch (A) and raise the liftgate.

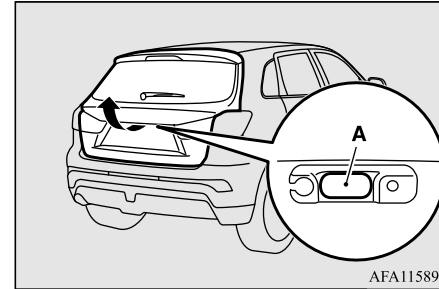

📖 NOTE

- The liftgate cannot be opened if it is not raised immediately after pressing the liftgate OPEN switch. If this happens, press the liftgate OPEN switch again and raise the liftgate.
- The liftgate cannot be opened when the battery is discharged or disconnected. The liftgate must then be opened using the inside liftgate release.
- When the battery is reconnected, all doors and the liftgate will be locked. Unlock them before trying to open the liftgate.

NOTE

- On vehicles equipped with the mirror retractor switch, the outside rearview mirrors will automatically extend when the liftgate and all doors are unlocked using the liftgate OPEN switch (A).

To close

Pull the liftgate grip (A) downward as illustrated and release it before the liftgate closes completely. Gently slam the liftgate from the outside so that it is completely closed.

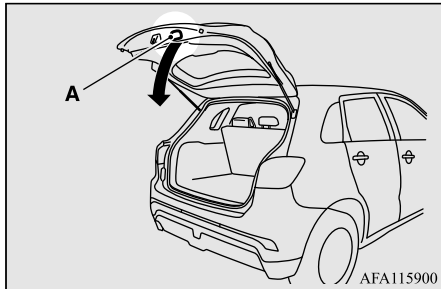

CAUTION

- To avoid injuring your hand or arm, do not attempt to close the liftgate without releasing the liftgate grip (A).

NOTE

- Gas struts (B) are installed in the locations illustrated in order to support the liftgate.

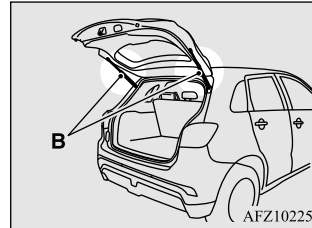

Please observe the following in order to prevent damage or faulty operation:

- Do not touch, push or pull the gas struts when closing the liftgate.
- Do not attach any plastic material, tape, etc., to the gas struts.
- Do not tie string, etc., around the gas struts.
- Do not hang objects on the gas struts.

Inside liftgate release

N00523101097

The inside liftgate release is designed to provide a way to open the liftgate if the battery is dead or disconnected.

The liftgate release lever (see illustration) is mounted on the liftgate.

Inside liftgate release

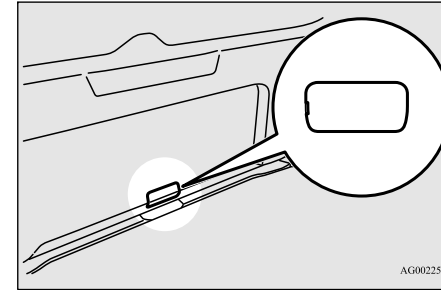

5

You and your family should familiarize yourselves with the location and operation of the liftgate release lever.

To open

1. Open the lid (A) inside of the liftgate.

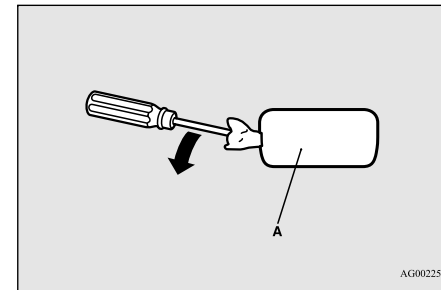

2. Move the lever (B) to open the liftgate.

Theft-alarm system

5

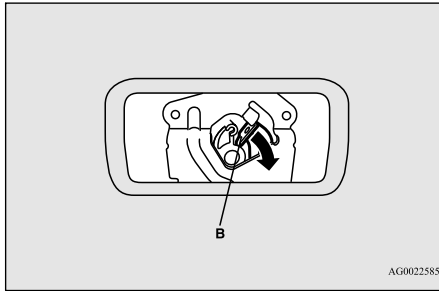

3. Push out on the liftgate to open it.

WARNING

- Always keep the release lever lid on the liftgate closed when driving so that your luggage cannot accidentally bump the lever and open the liftgate.

Theft-alarm system

N00510201313

The theft-alarm system is designed to provide protection from unauthorized entry into the vehicle. This system is operated in three stages: the first is the “armed” stage, the second is the “alarm” stage, and third is the “disarmed” stage. If triggered, the system provides both audible and visual alarm signals.

CAUTION

- Do not modify or add parts to the theft-alarm system. Doing so could cause the theft-alarm to malfunction.

Armed stage

Park the vehicle and stop the engine. Arm the system as described below.

1. Except for vehicles equipped with the F.A.S.T.-key, remove the key from the ignition switch.
For vehicles equipped with the F.A.S.T.-key, put the operation mode in OFF.
2. Make sure that the engine hood is closed.
3. Lock all doors and the liftgate by using the keyless entry system or the F.A.S.T.-key operation.

Arm the system and leave

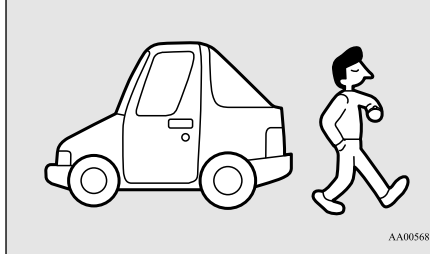

At this time, the theft-alarm indicator (A) on the audio panel flashes for confirmation.

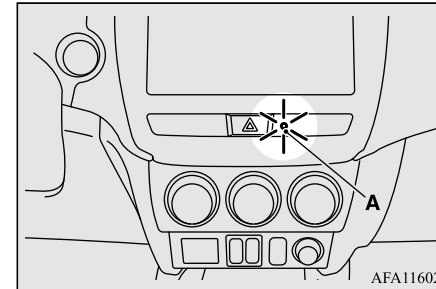

4. The system has entered the armed stage after about 20 seconds, when the theft-alarm indicator (A) flashing becomes slower.
The theft-alarm indicator (A) continues to flash while the system is in the armed stage.

NOTE

- If the engine hood is open, the theft-alarm indicator (A) illuminates and the system cannot enter the armed stage.
The system enters the armed stage about 20 seconds after the engine hood is closed.
- The system will be disarmed if, while the theft-alarm indicator (A) is illuminated, all doors and the liftgate are unlocked by using the keyless entry system or the F.A.S.T.-key operation.

Theft-alarm system

NOTE

- The system will be disarmed if, while the theft-alarm indicator is illuminated, the following operation is performed.
 - Except for vehicles equipped with the F.A.S.T.-key, if the ignition switch is turned to the “ON” position.
 - For vehicles equipped with the F.A.S.T.-key, if the operation mode is put in ON.
- The system will not be armed if a door, the liftgate or the engine hood is not completely closed. If this happens, rearm the system as described above.
- The theft-alarm system can be activated when people are riding inside the vehicle or when the windows are open. To prevent accidental activation of the alarm, do not set the system to the system armed mode while people are riding in the vehicle.

Alarm stage

The alarm will be activated if any of the following occur while the vehicle is parked and the system is armed.

- One of the doors and the liftgate is opened without using the keyless entry system or the F.A.S.T.-key operation.
- The engine hood is opened.

Type of alarm

When the alarm is activated:

1. The headlights blink on and off for 3 minutes.
After 3 minutes the headlights automatically shut off.
2. The horn will sound intermittently for 3 minutes.

Horn sounds!
Headlights blink on and off!

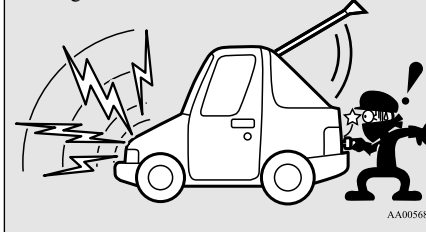

NOTE

- The alarm will continue to operate for 3 minutes. At the end of that period, the alarm will automatically shut off to save battery power. The system will then be rearmed until the proper disarming step is taken.
- The alarm will resume if unauthorized actions are taken again, even if the alarm has stopped.

NOTE

- While the alarm is operating, a warning is displayed on the information screen in the multi-information display.

Type 1



5

Type 2



Alarm deactivation

The alarm can be deactivated in the following ways.

- By using the keyless entry system or the F.A.S.T.-key operation to lock or unlock the doors and the liftgate.
- Except for vehicles equipped with the F.A.S.T.-key, by turning the ignition switch to the “ON” position.
- For vehicles equipped with the F.A.S.T.-key, by putting the operation mode in ON.

Power window control

Disarmed stage

The system will be disarmed if the following operation is performed.

5

- Except for vehicles equipped with the F.A.S.T.-key, if the ignition switch is turned to the “ON” position.
- For vehicles equipped with the F.A.S.T.-key, if the operation mode is put in ON.
- All doors and the liftgate are unlocked by using the keyless entry system or the F.A.S.T.-key operation.

Disarm...by the keyless entry system or the F.A.S.T.-key operation

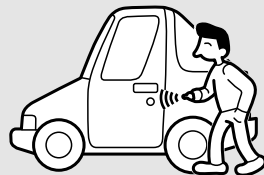

AA0070940

NOTE

- If the UNLOCK button on the remote control transmitter, or the driver's or front passenger's door lock/unlock switch is pressed when all doors and the liftgate are closed and no door is opened within approximately 30 seconds, re-arming will automatically occur.

NOTE

- The amount of time after unlocking until the vehicle relocks automatically can be adjusted. See an authorized Mitsubishi Motors dealer for details.
- Once the system has been disarmed, it cannot be rearmed except by repeating the arming procedure.

Testing the theft-alarm system

Use the following procedure to test the system:

1. Lower the driver's window.
2. Arm the system as explained in “Armed stage”.
3. Make sure that the theft-alarm indicator comes on and flashes for approximately 20 seconds.
4. Wait a few seconds and then unlock the driver's side door by using the inside door lock knob and open the door.
5. Make sure that the horn sounds intermittently and the headlights blink when a door is opened.
6. Disarm the system by unlocking all doors and the liftgate by using the keyless entry system or the F.A.S.T.-key operation.

Power window control

N00510800370

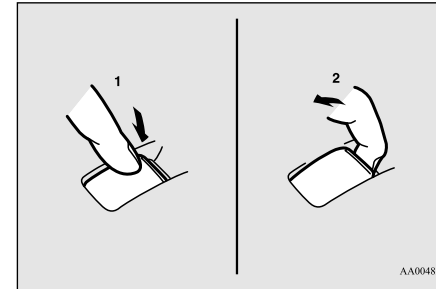

AA0048266

- 1- Open (down)
- 2- Close (up)

NOTE

- Never try to operate the main switch and sub-switch in different directions at the same time. This will freeze the window in position.
- Operating the power windows repeatedly with the engine stopped will run down the battery. Use the window switches only while the engine is running.

WARNING

- Before operating the power windows, make sure that nothing can be trapped (head, hands, fingers, etc.) in the window.

WARNING

- Never leave the vehicle without carrying the key.
- Never leave children or unreliable adults unattended inside the vehicle.

Main switch

N00548700097

The main switch located on the driver's door can be used to operate all the windows. A window can be opened or closed by operating the corresponding switch. Press the switch down to open the window, and pull up the switch to close it. If the driver's door window switch is fully pressed down/pulled up, the driver's door window automatically opens/closes completely. If you want to stop the window movement, operate the switch lightly in the reverse direction.

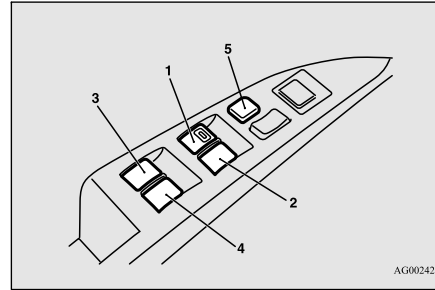

- 1- Driver's door window switch
- 2- Front passenger door window switch
- 3- Left rear door window switch
- 4- Right rear door window switch
- 5- Lock switch

Power window control

Sub switch

N00548800098

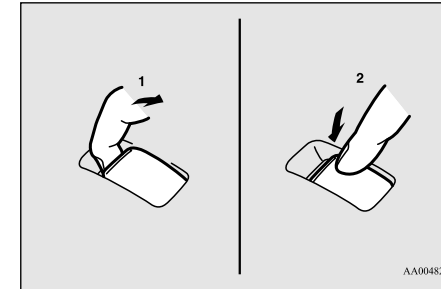

- 1- Close
- 2- Open

5

Each sub-switch can be used for its own passenger door window, unless the driver's window lock switch is activated.

NOTE

- The rear door windows open only half-way.

Power window timer function

N00548900132

The power windows can be run up or down when the ignition switch or the operation mode is in ON.

The door windows can be opened or closed for a 30-second period after the engine is

Power window control

stopped. However, once the driver's door or the front passenger's door is opened, the power windows cannot be operated.

Lock switch

N00549000130

5

When this switch is in the lock mode, the passenger door switches cannot be used to open or close the door windows, and the main switch will open or close only the driver's door window. To unlock the switch, press it again.

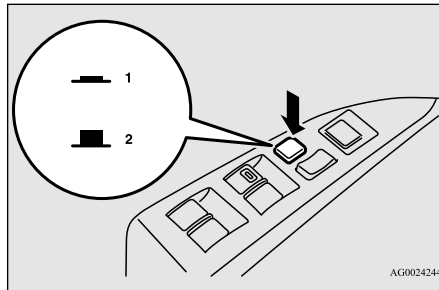

AG00024244

- 1- Lock
- 2- Unlock

WARNING

- Before driving with a child in the vehicle, be sure to lock the window switch to make it inoperative. Children tampering with the switch could easily trap their hands or heads in the window.

Safety mechanism (Driver's door window only)

N00528801132

If a hand or head is trapped, for safety the door window is automatically lowered a little. After the door window is lowered, pull up the switch again to close the door window.

WARNING

- If the battery terminals are disconnected or the fuse for power window is replaced, the safety mechanism will be cancelled. If a hand or head got trapped, a serious injury could result.

CAUTION

- The safety mechanism is deactivated just before the door window closes. This allows the door window to close completely. Therefore be especially careful that fingers are not trapped in the door window opening.

CAUTION

- The safety mechanism is deactivated while the switch is pulled up. Therefore be especially careful that fingers are not trapped in the door window opening.
- Do not deliberately trap your hands or head in order to activate the safety mechanism. Your hand or head could be trapped and personal injury could result.

NOTE

- The safety mechanism can be activated if the driving conditions or other circumstances cause the door window to be subjected to a physical shock similar to that caused by trapped hand or head.
- If the battery terminals are disconnected or the fuse for the power window is replaced, the safety mechanism will be cancelled and the door window will not automatically open/close completely. If the window is open, repeatedly raise the driver's door window switch until the window has been fully closed. Following this, release the switch, raise the switch once again and hold it in this condition for at least 1 second, then release it. You should now be able to operate the driver's door window in the normal fashion.

What to do if you hear wind buffeting when driving

N00551400043

Wind buffeting can be described as the perception of pressure on the ears or a booming or rumbling sound. Your vehicle may exhibit wind buffeting when driving with one or both rear door windows down or partially opened. This is a normal occurrence that can be minimized. If the buffeting occurs with the rear door windows open, open the front door windows as well as the rear door windows to minimize the condition.

Sunshade (if so equipped)

N00511001712

WARNING

- Before operating the sunshade, make sure that nothing can be trapped (head, hands, fingers, etc.).
- Never leave the vehicle without carrying the key.
- Never leave a child (or other person who is incapable of safely operating the sunshade switch) alone in the vehicle.

WARNING

- Do not bring your head, hand, finger, etc. near the opening edge of the sunshade receptacle while the vehicle is in motion. It may cause injury to your head, hand, finger, etc. in the event of a sudden braking.

CAUTION

- Do not place heavy luggage on the panoramic glass roof. Doing so could damage the glass roof.
- Do not hang heavy luggage from, allow a person to hang onto, or apply any other strong force to the opening of the sunshade receptacle or the parts between the ceiling and the sunshade opening on either side. Doing so could damage the sunshade.

NOTE

- Release the switch when the sunshade has reached a completely open or completely closed position.
- If the sunshade does not operate when the sunshade switch is operated, release the switch and check whether something is trapped by the sunshade. If nothing is trapped, have the sunshade checked at an authorized Mitsubishi Motors dealer.

Sunshade (if so equipped)

NOTE

- Operating the sunshade repeatedly with the engine turned off will run down the battery. Operate the sunshade only while the engine is running.
- Close the sunshade when parking the vehicle for a long time. Parking in the hot sun with the sunshade open will make the vehicle inside extremely hot.

5

The sunshade can be opened and closed with the ignition switch or the operation mode in ON.

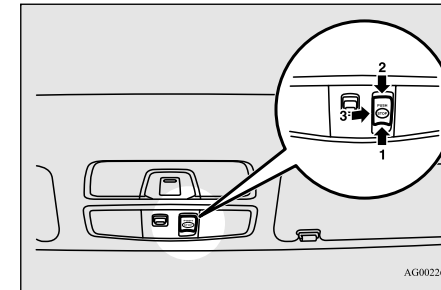

To open

Press the switch (1), the sunshade opens. Press and hold the switch (1), the sunshade automatically opens. Release the switch once the sunshade starts moving automatically.



Parking brake

To stop the moving sunshade, press the switch (1), (2) or (3).

To close

Press the switch (2), the sunshade closes. Press and hold the switch (2), the sunshade automatically closes. Release the switch once the sunshade starts moving automatically.

5

To stop the moving sunshade, press the switch (1), (2) or (3).

Safety mechanism

If a hand or head is trapped in the closing sunshade opening, the safety mechanism will cause the sunshade to re-open automatically. The opened sunshade will become operational again after a few seconds.

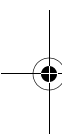

 **NOTE**

- The safety mechanism can be activated if the driving conditions or other circumstances cause the sunshade to be subjected to a physical shock similar to that caused by a trapped hand or head.

CAUTION

- Do not deliberately trap your hands or head in order to activate the safety mechanism. Personal injury and malfunction of the sunshade could result.

Parking brake

N00511400373

To park the vehicle, first bring it to a complete stop, fully engage the parking brake, and then move the gearshift lever to 1st (on a uphill) or “R” (Reverse) (on a downhill) position for vehicles equipped with a manual transaxle, set the selector lever to “P” (PARK) position for vehicles equipped with a continuously variable transmission (CVT).

To apply

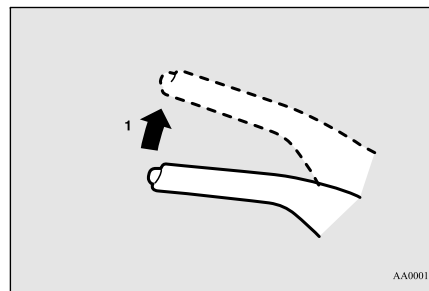

1- Pull the lever up without pushing the button at the end of hand grip.

When the parking brake is set and the ignition switch are in the “ON” position, the brake warning light in the instrument cluster will come on.

Before driving, be sure to release the parking brake.

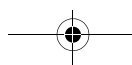
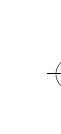

To deactivate

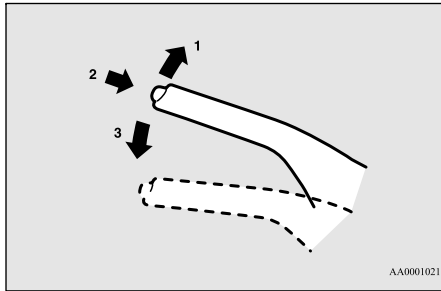

- 1- Pull the lever up slightly.
- 2- Press and hold the button at the end of the hand grip.
- 3- Push the lever downward.

When parking on a hill, set the parking brake, and turn the front wheels toward the curb on a downhill, or away from the curb on an uphill.

CAUTION

- Before driving, be sure that the parking brake is fully released and brake warning light is off.
- If you drive without the parking brake fully released, the warning display will appear on the information screen in the multi-information display.
- If a vehicle is driven without releasing the parking brake, the brakes will be overheated, resulting in ineffective braking and possible brake failure.

Warning light



Warning display type 1



Warning display type 2



Steering wheel height and reach adjustment

Steering wheel height and reach adjustment

N00511500228

To adjust the steering wheel to the desired position, move the lever upward or downward while moving the steering wheel to the desired level.

5

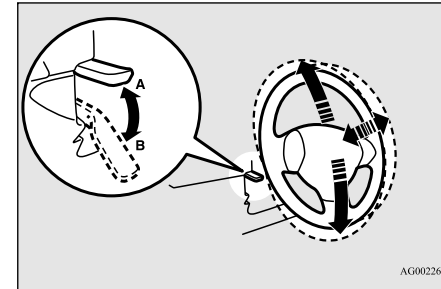

- A- Wheel lock
- B- Release

WARNING

- After adjusting, make sure the lever is secured in the locked (A) position.
- Do not attempt to adjust the steering wheel while driving. This can be dangerous.

Inside rearview mirror

⚠ WARNING

- When releasing the lever (moving it to the position (B)), be sure to hold the steering wheel firmly. Otherwise, the steering wheel may slip down too suddenly.

5

Inside rearview mirror

N00511601369

Adjust the inside rearview mirror only after making any seat adjustments so as to have a clear view to the rear of the vehicle.

⚠ WARNING

- Do not attempt to adjust the inside rearview mirror while driving. This can be dangerous. Be sure to adjust the mirror before driving.

Type 1

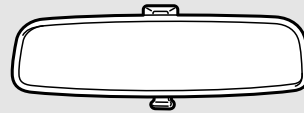

Type 2

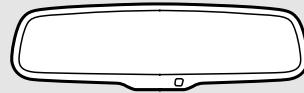

Type 3

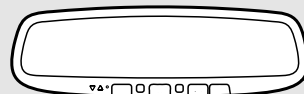

AJ4100525

Adjust the inside mirror to maximize the view through the rear window.

To adjust the vertical mirror position

It is possible to move the mirror up and down to adjust its position.

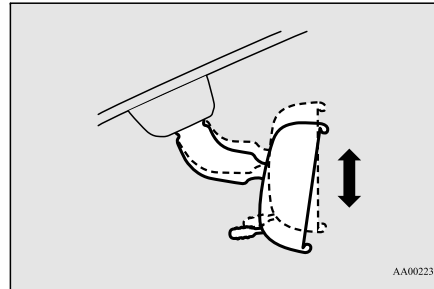

To adjust the mirror position

It is possible to move the mirror up/down and left/right to adjust its position.

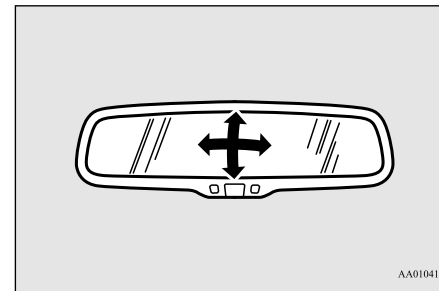

Inside rearview mirror

To reduce the glare

Type 1

The day/night knob (A) at the bottom of the mirror can be used to adjust the mirror to reduce the glare from the headlights of vehicles behind you during night driving.

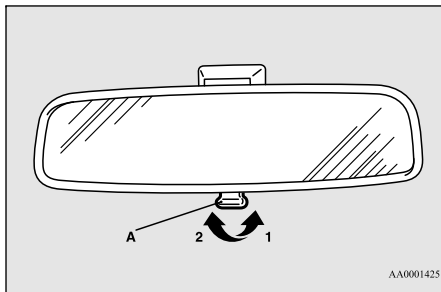

- 1- Daytime position
- 2- Night position

Type 2

When the headlights of the vehicles behind you are very bright, the reflection factor of the rearview mirror is automatically changed to reduce the glare.

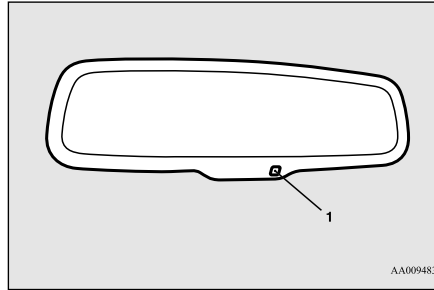

Normally, use the automatic mode. When the ignition switch is turned to the "ON" position or the operation mode is put in ON, the reflection factor of the mirror is automatically changed.

NOTE

- Do not hang items on, or spray glass cleaner on the sensor (1), as reduced sensitivity could result.

Type 3

When the headlights of the vehicles behind you are very bright, the reflection factor of the rearview mirror is automatically changed to reduce the glare.

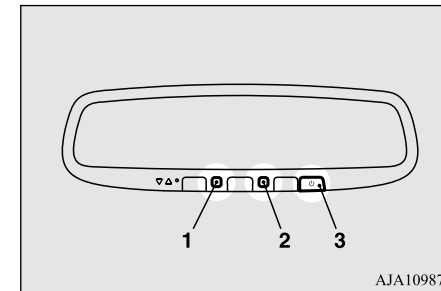

5

Normally, use the automatic mode. When the ignition switch is turned to the "ON" position or the operation mode is put in ON, the green indicator (1) illuminates and the reflection factor of the mirror is automatically changed.

NOTE

- Do not hang items on, or spray glass cleaner on the sensors (2), as reduced sensitivity could result.

Outside rearview mirrors

5

NOTE

- If you want to stop automatic mode, press the switch (3) and the indicator will go off. To return to automatic mode, press the switch again or perform the following operation.
[Except for vehicles equipped with the Free-hand Advanced Security Transmitter (F.A.S.T.-key)]
Turn the ignition switch to the "ON" position after turning to "OFF" or "ACC" position.
[For vehicles equipped with the Free-hand Advanced Security Transmitter (F.A.S.T.-key)]
Put the operation mode in ON after putting the operation mode in OFF.

Outside rearview mirrors

N00512200206

Adjust the outside rearview mirrors only after making any seat adjustments so as to have a clear view to the rear of the vehicle.

WARNING

- Do not attempt to adjust the outside rearview mirrors while driving. This can be dangerous.
Be sure to adjust the mirrors before driving.

WARNING

- Your passenger's side mirror is convex. The objects you see in the mirror will look smaller and farther away than they appear in a regular flat mirror. Do not use this mirror to estimate the distance of vehicles following you when changing lanes.

To adjust the mirror position

N00549101170

The outside rearview mirrors can be adjusted when the ignition switch or the operation mode is in ON or ACC.

Move the lever (A) to the same side as the mirror you wish to adjust.

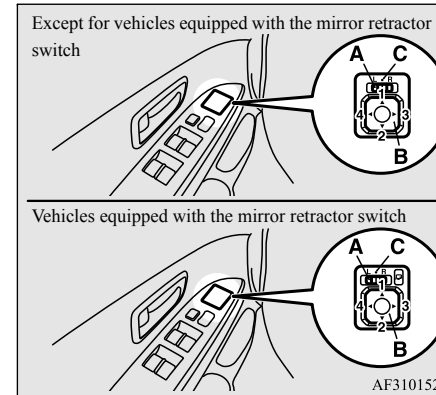

- L- Left outside mirror adjustment
- R- Right outside mirror adjustment

Press the switch (B) to adjust the mirror position.

- 1-Up
- 2-Down
- 3-Right
- 4-Left

Outside rearview mirrors

NOTE

- After adjusting, return the lever to the “•” (OFF) position (C).

Retracting and extending the mirrors

N00549201155

The outside mirror can be retracted towards the side window to prevent damage when parking in tight locations.

Except for vehicles equipped with the mirror retractor switch

Push the mirror towards the back of the vehicle with your hand to retract it. When extending the mirror, pull it out towards the front of the vehicle until it clicks to lock in place.

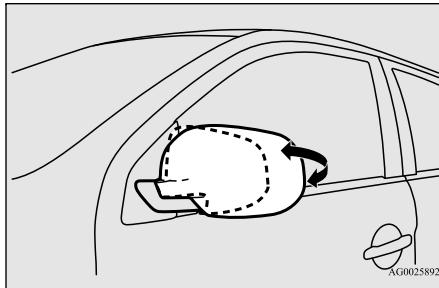

For vehicles equipped with the mirror retractor switch

Retracting and extending the mirrors using the mirror retractor switch

With the operation mode in ON or ACC, push the mirror retractor switch to retract the mirrors. Push it again to extend the mirrors to their original positions.

After placing the operation mode in OFF, it is possible to retract and extend the mirrors using the mirror retractor switch for about 30 seconds.

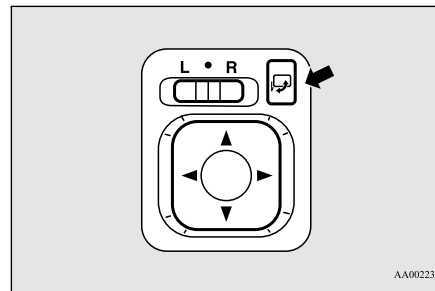

CAUTION

- It is possible to retract and extend the mirrors by hand. After retracting a mirror using the mirror retractor switch, however, you should extend it by using the switch again, not by hand. If you extended the mirror by hand after retracting it using the switch, it would not properly lock in position. As a result, it could move because of the wind or vibration while you are driving, taking away your rearward visibility.

5

NOTE

- Be careful not to get your hands trapped while a mirror is moving.
- If you move a mirror by hand or it moves after hitting a person or object, you may not be able to return it to its original position using the mirror retractor switch. If this happens, push the mirror retractor switch to place the mirror in its retracted position and then push the switch again to return the mirror to its original position.
- When freezing has occurred and mirrors fail to operate as intended, please refrain from repeated pushing of the retractor switch as this action can result in burn-out of the mirror motor circuits.

Ignition switch

Retracting and extending the mirrors without using the mirror retractor switch (automatic extension function)

5

On vehicles equipped with the F.A.S.T.-key, the mirrors automatically retract or extend when the doors are locked or unlocked using the remote control transmitter buttons or the F.A.S.T.-key. Refer to “Keyless entry system” on page 5-25 or “To operate using the F.A.S.T.-key” on page 5-14.

NOTE

- Functions can be modified as stated below. Please consult an authorized Mitsubishi Motors dealer.
- Automatically extend when the operation mode is put in ON with the driver’s door closed, and automatically retract when the operation mode is put in OFF with the driver’s door opened.
- Automatically extend when the vehicle speed reaches approximately 19 mph (30 km/h).
- Deactivate the automatic extension function.

Door mirror heater

N00549300191

When the rear window defogger switch is pressed with the engine running, the outside rearview mirrors are defogged or defrosted. Current will flow through the heater element inside the mirrors, thus clearing away frost or condensation. The indicator light (A) will illuminate while the defogger is on. The heater will be turned off automatically in about 20 minutes.

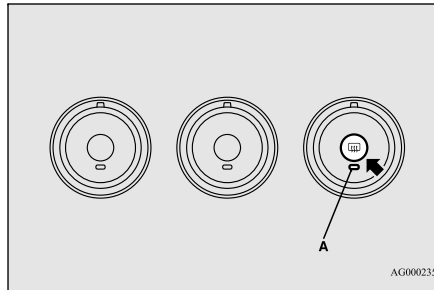

AG0002358

Ignition switch

N00512400673

[For vehicles equipped with the Free-hand Advanced Security Transmitter (F.A.S.T.-key)]

For information on operations for vehicles equipped with the Free-hand Advanced Security Transmitter (F.A.S.T.-key), refer to “Free-hand Advanced Security Transmitter (F.A.S.T.-key): Engine switch” on page 5-16.

[Except for vehicles equipped with the Free-hand Advanced Security Transmitter (F.A.S.T.-key)]

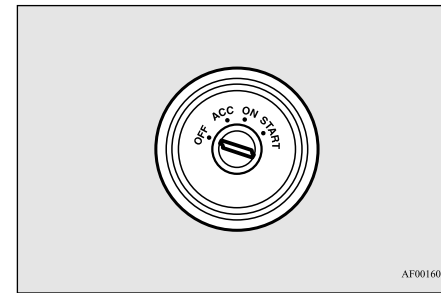

AF0016079

OFF

The engine is off. The key can be inserted and removed only when the switch is in this position.

ACC

Allows operation of electrical accessories with the engine off.

ON

The engine runs and all accessories can be used.

START

Engages the starter. Release the key when the engine starts. It will automatically back to the "ON" position.

NOTE

- Your vehicle is equipped with an electronic immobilizer. To start the engine, the ID code which the transponder inside the key sends must match the one registered to the immobilizer computer. (Refer to "Electronic immobilizer" on page 5-23.)

ACC power auto-cutout function

N00539601114

After about 30 minutes has elapsed with the ignition switch in the "ACC" position, the function automatically cuts out the power for the audio system and other electric devices that can be operated with that position. When the ignition switch is turned from the "ACC" position, the power is supplied again to those devices.

NOTE

- It is possible to modify functions as follows:
 - The time until the power cuts out can be changed to about 60 minutes.
 - The ACC power auto-cutout function can be deactivated.

For details, we recommend you to consult an authorized Mitsubishi Motors dealer.

To remove the key

N00550900197

1. Set the selector lever to the "P" (PARK) position {continuously variable transmission (CVT)}.
2. Turn the key to the "OFF" position and remove it.

Starting the engine

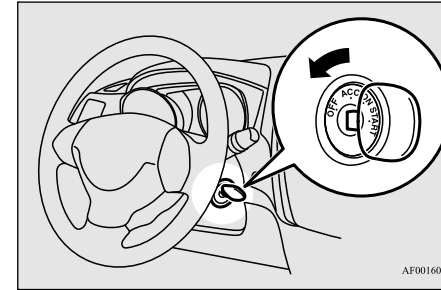

5

CAUTION

- If the engine is stopped while driving, the brake servomechanism will cease to function and braking efficiency will deteriorate. Also, the power steering system will not function and it will require greater manual effort to operate the steering.
- Do not leave the key in the "ON" position for a long time when the engine is not running, doing so will cause the battery to be discharged.
- Do not turn the key to the "START" position when the engine is running, doing so could damage the starter motor.

Starting the engine

N00512601887

[For vehicles equipped with the Free-hand Advanced Security Transmitter (F.A.S.T.-key)]

Starting the engine

For information on operation for vehicles equipped with the Free-hand Advanced Security Transmitter (F.A.S.T.-key), refer to “Free-hand Advanced Security Transmitter (F.A.S.T.-key): Starting and stopping the engine” on page 5-20.

5

[Except for vehicles equipped with the Free-hand Advanced Security Transmitter (F.A.S.T.-key)]

Tips for starting

- Do not operate the starter motor continuously for longer than 15 seconds as this could run the battery down or damage the starter motor. If the engine does not start, turn the ignition switch back to the “OFF” position, wait a few seconds, and then try again. Trying repeatedly with the engine or starter motor still turning will damage the starter mechanism.
- If the engine will not start because the battery is weak or discharged, refer to “Jump-starting the engine” (on page 8-2) for instructions.

- A longer warm up period will only consume extra fuel. The engine is warmed up enough for driving when the bar graph of engine coolant temperature display starts to move. Refer to “Interrupt display screen (With ignition switch or operation mode in ON)” on page 5-106.

WARNING

- **Never run the engine in a closed or poorly ventilated area any longer than is needed to move your vehicle out of the area. Carbon monoxide gas, which is odorless and extremely poisonous, could build up and cause serious injury or death.**

CAUTION

- Do not push-start the vehicle.
- Do not run the engine at high rpms or drive at high speeds until the engine has had a chance to warm up.
- Release the ignition switch as soon as the engine starts. Otherwise, the starter motor will be damaged.

Starting the engine

This model is equipped with an electronically controlled fuel injection system. This is a system that automatically controls fuel injection.

There is usually no need to depress the accelerator pedal when starting the engine.

The starter should not be run for more than 15 seconds at a time.

To prevent battery drain, wait a few seconds between attempts to restart the engine.

1. Make sure all occupants are properly seated with seat belts fastened.
2. Insert the ignition key.
3. Make sure the parking brake is applied.
4. Press and hold the brake pedal down firmly with your right foot.
5. Press and hold the clutch pedal all the way down (manual transaxle).
6. On vehicles equipped with manual transaxle, place the gearshift lever in the “N” (Neutral) position.
On vehicles equipped with continuously variable transmission (CVT), make sure the selector lever is in the “P” (PARK) position.

NOTE

- On vehicles equipped with CVT, the starter will not operate unless the selector lever is in the “P” (PARK) or “N” (NEUTRAL) position.
For safety reasons, start the engine in the “P” (PARK) position so that the wheels are locked.

7. Turn the ignition switch to the “ON” position and make certain that all warning lights are functioning properly before starting the engine.
8. Turn the ignition switch to the “START” position without pressing the accelerator pedal. Release the key when the engine starts.

NOTE

- Minor noises may be heard on engine start-up. These will disappear as the engine warms up.

When the engine is hard to start

After several attempts, you may experience that the engine still does not start.

1. Make sure that all electric devices, such as lights, air conditioning blower and rear window defogger, are turned off.
2. While depressing the brake pedal {continuously variable transmission (CVT)} or the clutch pedal (manual transaxle), press the accelerator pedal halfway and hold it there, then crank the engine. Release the accelerator pedal, immediately after the engine starts.

3. If the engine still will not start, the engine could be flooded with too much gasoline. While depressing the brake pedal (CVT) or the clutch pedal (manual transaxle), push the accelerator pedal all the way down and hold it there, then crank the engine for 5 to 6 seconds. Return the ignition switch to the “OFF” position and release the accelerator pedal. Wait a few seconds, and then crank the engine again for 5 to 6 seconds while depressing the brake pedal (CVT) or the clutch pedal (manual transaxle), but do not push the accelerator pedal. Release the ignition switch if the engine starts. If the engine fails to start, repeat these procedures. If the engine still will not start, contact your local Mitsubishi Motors dealer or a repair facility of your choice for assistance.

Startability of automatic transaxle vehicle and CVT vehicle with ambient temperature of -22 °F (-30 °C) or lower

When the ambient temperature is -22 °F (-30 °C) or lower, it may not be possible to start from a standstill even with the selector lever in the “D” (DRIVE) or “R” (REVERSE) position.

Manual transaxle (if so equipped)

This occurs because the transaxle has not warmed up sufficiently; it does not indicate a problem. If this occurs, place the selector lever in the “P” (PARK) position and let the engine idle for at least 10 minutes. The transaxle will warm up, and you will be able to start normally. Do not leave the vehicle during warm-up operation.

5

Manual transaxle (if so equipped)

N00512701208

The shift pattern below is shown on the gear-shift lever. Press the clutch pedal all the way down while shifting gears.

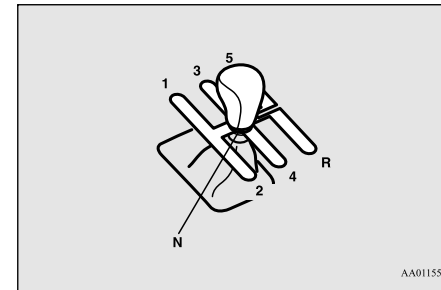

AA0115573

Manual transaxle (if so equipped)

NOTE

- During cold weather, shifting may be difficult until the transaxle lubricant has warmed up. This is normal and not harmful to the transaxle.

5 To start

Press the clutch pedal all the way down and shift into 1st or “R” (Reverse) position. Then gradually release the clutch pedal while depressing the accelerator pedal.

CAUTION



- Do not move the gearshift lever into reverse while the vehicle is moving forward; doing so will damage the transaxle.
- Do not rest your foot on the clutch pedal because this will cause premature clutch wear or damage.
- Do not coast in the “N” (Neutral) position (illegal in many states).
- Do not use the gearshift lever as a handrest, because this can result in premature wear of the transaxle shift forks.

NOTE

- If it is hard to shift into 1st, depress the clutch pedal a second time; the shift will then be easier.

5-50 Features and controls

NOTE

- To shift into reverse from 5th gear, move the gearshift lever to the “N” (Neutral) position, and then shift it into reverse.
- The gearshift indicator shows recommended gearshift points for fuel-efficient driving. It shows a “ SHIFT” when an upshift is recommended, and it shows a “ SHIFT” when a downshift is recommended.

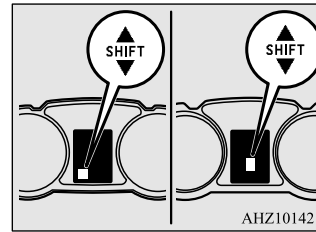

Proper shift points

N00537400052

Always use care to change the gear with the vehicle speed matched to the engine speed. Proper shifting will improve fuel economy and prolong engine life.

CAUTION

- Avoid downshifting that may cause the tachometer pointer to enter the red zone. This puts the engine at risk of being damaged.

Upshifting

N00512901154

For the best fuel economy and performance in using your manual transaxle, upshift as listed below.

At low altitude locations, upshift as listed below.

Shift point	Upshift speeds
1st gear to 2nd gear	15 mph (24 km/h)
2nd gear to 3rd gear	25 mph (40 km/h)
3rd gear to 4th gear	40 mph (64 km/h)
4th gear to 5th gear	45 mph (72 km/h)

At high altitude locations, upshift as listed below.

Shift point	Upshift speeds
1st gear to 2nd gear	15 mph (24 km/h)
2nd gear to 3rd gear	25 mph (40 km/h)
3rd gear to 4th gear	40 mph (64 km/h)
4th gear to 5th gear	45 mph (72 km/h)

Continuously variable transmission (CVT) (if so equipped)

Downshifting

N00513000096

It is recommended that you downshift to a lower gear when needed to maintain the desired speed, according to the table.

Avoid downshifting at too high a speed. The engine may suffer damage.

To maintain a safe speed and prolong brake life, shift down to 2nd or 1st when descending a steep hill.

Downshifting is also important to avoid “lugging” the engine at too low a speed, such as when turning a corner or when driving up a steep hill.

Recommended downshifting speed

Downshifting speed	Shift point
Under 20 mph (32 km/h)	Shift down from current gear to 2nd gear.
20 to 30 mph (32 to 48 km/h)	Shift down from current gear to 3rd gear.

Driving precautions

N00513101254

- Do not use the gearshift lever as a hand rest. This can result in premature wear of the transaxle shift forks.

Maximum possible driving speed

Shift points	Maximum possible driving speed
1st gear	28 mph (45 km/h)
2nd gear	59 mph (95 km/h)
3rd gear	86 mph (140 km/h)
4th gear	111 mph (180 km/h)

- The table above shows the maximum recommended driving speed in each gear. Do not drive near or at these speeds for prolonged periods of time.

Continuously variable transmission (CVT) (if so equipped)

N00560201086

The CVT will automatically and continuously change its gear ratio depending on road and driving conditions. This helps achieve smooth driving and excellent fuel efficiency.

If your vehicle is equipped with the sportronic steering wheel paddle shifter, you can manually shift the transmission up and down. Refer to “Sports mode” on page 5-56.

DRIVING UPHILL

The transmission prevents unnecessary upshifts even when the accelerator pedal is released and ensures smooth driving.

5**DRIVING DOWNHILL**

According to the conditions, the transmission will automatically shift to a lower gear ratio to achieve stronger engine braking. This may help reduce your need to use the service brake.

Selector lever operation

N00560301117

As an additional safety precaution, models equipped with a continuously variable transmission have a shift-lock device that holds the selector lever in the “P” (PARK) position. To move the selector lever from the “P” (PARK) position to another position, follow the steps below.

- Press and hold the brake pedal down.

Continuously variable transmission (CVT) (if so equipped)

2. Move the selector lever to the desired position.

NOTE

- The selector lever cannot be moved from “P” (PARK) to another position if the ignition switch is set to the “OFF” or “ACC” position, or if the key has been removed, or the operation mode is put in OFF or ACC, or if the brake pedal is not pressed and held down.

5

The CVT selects an optimum ratio automatically when the selector lever is in the “D” (DRIVE) position, depending on the speed of the vehicle and the position of the accelerator pedal.

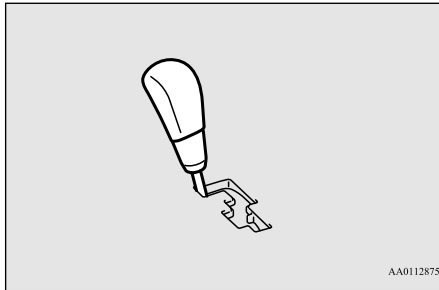

Except for vehicles equipped with sportronic steering wheel paddle shifter

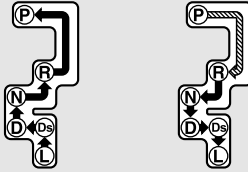

For vehicles equipped with sportronic steering wheel paddle shifter

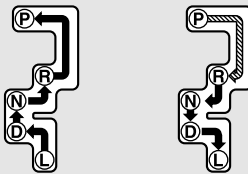

AJM100706

	Set the selector lever in the gate to operate while the brake pedal is depressed.
	Set the selector lever in the gate to operate.

WARNING

- Always press the brake pedal when shifting the selector lever into a selector position from the “N” (NEUTRAL) position. When beginning to drive, do not shift the selector lever from the “N” (NEUTRAL) position while pressing the accelerator pedal. This will cause the vehicle to “jump” forward or backward.

NOTE

- To prevent mistakes in operating the lever, make sure you stop briefly at each position. After operating, check the position in the multi-information display.
- If the brake pedal is not depressed and held, the shift-lock device activates to prevent the selector lever from being moved from the “P” (PARK) position.
- For a shift indicated by in the illustration, depress the brake pedal before moving the selector lever. If you attempt to move the selector lever before depressing the brake pedal, the selector lever may be immovable.

Continuously variable transmission (CVT) (if so equipped)

When the selector lever cannot be shifted from the “P” (PARK) position

N00563301088

When the selector lever cannot be shifted from the “P” (PARK) position to another position while the brake pedal is pressed and held down with the ignition switch or the operation mode in ON, the battery may be flat or the shift-lock mechanism may be malfunctioning.

Immediately have your vehicle checked by an authorized Mitsubishi Motors dealer or a repair facility of your choice.

If you need to move the vehicle, shift the selector lever as follows.

1. Make sure the parking brake is fully applied.
2. Stop the engine if it is running.
3. Insert a screwdriver with a cloth over its tip into the notch (A) of the cover. Pry gently as shown to remove the cover.

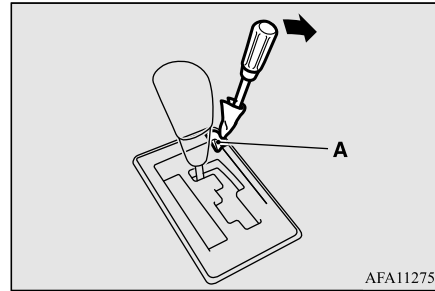

AFA112752

4. Depress the brake pedal with the right foot.
5. Insert a screwdriver in the shift-lock release hole (B). Shift the selector lever to the “N” (NEUTRAL) position while pressing the screwdriver down.

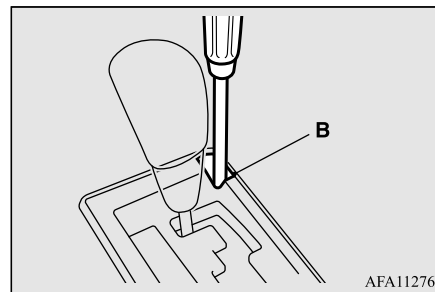

AFA112765

Selector lever position display

N00560401091

When the ignition switch is turned to the “ON” position or the operation mode is put in ON, the position of the selector lever is indicated in the multi-information display.

5

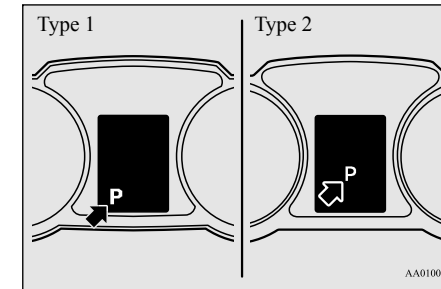

AA0100461

When the selector lever position display blinks

N00582900057

⚠ WARNING

- To avoid unintended vehicle movement, keep brake pedal applied with your right foot and do not depress the accelerator pedal, while the selector lever position display is blinking.

Continuously variable transmission (CVT) (if so equipped)

If the ambient temperature is low, the selector lever position display on the multi-information display may blink when the selector lever is placed in the “D” (DRIVE), “Ds” (DOWNSHIFT & SPORTY DRIVING), “L” (LOW) or “R” (REVERSE) position immediately after the engine has been started. This indicates that the transmission requires warming up. While the display is blinking, the vehicle will not move, because the transmission keeps disengaging until the warm up is completed even if the selector lever is placed in the “D”, “Ds”, “L” or “R” position.

5

When the selector lever position display is blinking, perform the following procedure:

1. Depress the brake pedal with your right foot and place the selector lever in the “N” (NEUTRAL) position for several seconds.
2. Keep depressing the brake pedal and then place the selector lever in the “D” (DRIVE), “Ds” (DOWNSHIFT & SPORTY DRIVING), “L” (LOW) or “R” (REVERSE) position. If the selector lever position display stops blinking, the warm up is completed and the transmission will function normally.
3. If the display is still blinking, repeat steps 1 and 2 above.

NOTE

- While the selector lever position display is blinking, a buzzer will sound intermittently.

Warning display

N0056050119

Type 1

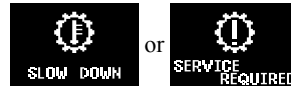

Type 2



When the warning display or the warning display appears on the information screen in the multi-information display while you are driving, there could be a malfunction in the CVT.

CAUTION

- If a malfunction occurs in the CVT while driving, the warning display or the warning display will appear on the information screen in the multi-information display. In this case, follow these procedures:
 - [When warning display is showing] The continuously variable transmission (CVT) fluid is overheating. The engine control may activate to lower the CVT fluid temperature, causing the engine revolutions and vehicle speed to decrease. In this case, take one of the following procedures.
 - Slow down your vehicle.
 - Stop your vehicle in a safe place, put the selector lever in the “P” (PARK) position, and open the engine hood with the engine running to allow the engine to cool down.

Continuously variable transmission (CVT) (if so equipped)

CAUTION

After a while, confirm that the  warning display is no longer showing. It is safe to continue driving if the display is no longer showing. If the warning display remains or flashes frequently, have your vehicle inspected by an authorized Mitsubishi Motors dealer or a repair facility of your choice.

[When  warning display is showing]

It may be that there is something unusual happening in the CVT, causing a safety device to activate. Immediately have your vehicle inspected by an authorized Mitsubishi Motors dealer or a repair facility of your choice.

Selector lever positions

N00560601123

“P” PARK

This position locks the transmission to prevent the vehicle from moving. The engine can be started from the “P” (PARK) position.

“R” REVERSE

Move the lever to this position only after the vehicle has come to a complete stop.

CAUTION

- Never shift into the “P” (PARK) or “R” (REVERSE) position while the vehicle is in motion. If the lever is shifted into the “P” (PARK) or “R” (REVERSE) position while the vehicle is in motion, the transmission may be damaged.

“N” NEUTRAL

At this position, the transmission is disengaged. It is the same as the neutral position on a manual transaxle and should be used when the vehicle is not moving for an extended length of time during driving, such as in a traffic jam.

WARNING

- Never move the selector lever to the “N” (NEUTRAL) position while driving since you could accidentally slip it into the “P” (PARK) or “R” (REVERSE) position, damaging the transmission.
- To prevent the vehicle from rolling when stopped on a slope, the engine should be started in the “P” (PARK) position, not in “N” (NEUTRAL) position.

WARNING

- To prevent rolling, always keep your foot on the brake pedal when the vehicle is in “N” (NEUTRAL) position, or when shifting into or out of “N” (NEUTRAL) position.

“D” DRIVE

This position is used for most city and highway driving. The transmission will automatically and continuously change its gear ratio depending on road and driving conditions.

CAUTION

- To prevent transmission damage, never shift into the “D” (DRIVE) position from the “R” (REVERSE) position while the vehicle is in motion.

“Ds” DOWNSHIFT & SPORTY-DRIVING (except for vehiclesequipped with sportronic steeringwheel paddle shifter)

Use when engine braking is needed, or for high-power sport drive.

5

Continuously variable transmission (CVT) (if so equipped)

“L” LOW

This position is for driving up very steep hills and for engine braking at low speeds when driving down steep hills.

5

WARNING

- This position can be used for maximum engine braking. Be very careful not to shift into “L” (LOW) suddenly. Sudden engine braking may cause the tires to skid. Select this position according to the road conditions and vehicle speed.

Sports mode (for vehicles equipped with sportronic steering wheel paddle shifter)

N00560701111

While the vehicle is stopped or being driven with the selector lever in the “D” (DRIVE), sports mode can be selected by pulling one of the sportronic steering wheel paddle shifter towards you.

In sports mode, rapid shifting is possible simply by operating the sportronic steering wheel paddle shifter.

Unlike the manual transaxle, sports mode allows shifting with the accelerator pedal depressed.

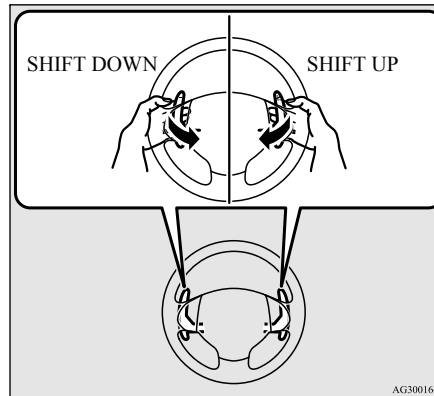

+ (SHIFT UP)

Transmission shifts up once by each operation.

- (SHIFT DOWN)

Transmission shifts down once by each operation.

To return to “D” (DRIVE) operation, pull the sportronic steering wheel paddle shifter on the + (SHIFT UP) side for longer than 2 seconds.

When returning to “D” (DRIVE) operation, the selector lever position display will change to the “D” (DRIVE) position.

CAUTION

- In sports mode, the driver must execute upward shifts in accordance with prevailing road conditions, taking care to keep the engine speed below the red zone.
- Repeated continuous operation of the sportronic steering wheel paddle shifter will continuously switch shift position.
- Shift ranges may not change when the lateral paddle shifters are operated at the same time.

NOTE

- The upward shift may be made automatically in sports mode when the engine revolutions rises and approach the tachometer’s red zone (the red-colored part of the tachometer dial).
- Shift ranges can only be selected in a forward direction from 1st to 6th. To reverse or park the vehicle, move the selector lever to the “R” or “P” position.

Continuously variable transmission (CVT) (if so equipped)

NOTE

- To maintain good running performance, the transmission may refuse to perform an upshift when the sportronic steering wheel paddle shifter on the “+ (SHIFT UP)” side is pulled at certain vehicle speeds. Also, to prevent over-revving of the engine, the transmission may refuse to perform a downshift when the sportronic steering wheel paddle shifter on the “- (SHIFT DOWN)” side is pulled at certain vehicle speeds. When this happens, a buzzer sounds to indicate that a downshift is not going to take place.
- In sports mode, downward shifts are made automatically when the vehicle slows down. When the vehicle stops, 1st position is automatically selected. Also, the vehicle will automatically return to “D” (DRIVE) operation if the vehicle is stopped.
- When the selector lever is in the “L” (LOW) position, the sports mode is not selected even if you operate the sportronic steering wheel paddle shifter.

Sports mode display

N00560901070

In sports mode, the currently selected shift range is displayed on the information screen in the multi-information display.

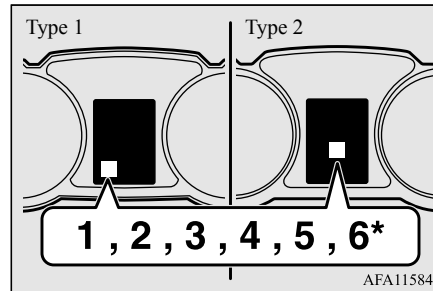

*: if so equipped

Operation of the CVT

N00560801112

CAUTION

- Before selecting a position with the engine running and the vehicle stationary, firmly depress the brake pedal to prevent the vehicle from creeping. The vehicle will begin to move as soon as the CVT is engaged, especially when the engine speed or idle speed is high, or with the air conditioning operating. Do not release the brake pedal until you are ready to drive away.
- Depress the brake pedal with the right foot at all times. Using the left foot could cause driver movement delay in case of an emergency.

CAUTION

- To prevent sudden acceleration, never run the engine at high rpms when shifting from the “P” (PARK) or “N” (NEUTRAL).
- Operating the accelerator pedal while the other foot is resting on the brake pedal will affect braking efficiency and may cause premature wear of brake pads.
- Use the selector lever in the correct shift position in accordance with driving conditions. Never coast downhill backward in the driving shift position {“D” (DRIVE), “Ds” (DOWN SHIFT & SPORTY DRIVING), “L” (LOW) position or sports mode} or coast forward in the “R” (REVERSE) position. Engine stopping and increased brake pedal and steering effort could lead to an accident.
- Do not rev the engine with the brake pedal pressed when the vehicle is stationary. This can damage the CVT. Also, when you depress the accelerator pedal while holding down the brake pedal with the selector lever in the “D” (DRIVE) position, the engine revolutions may not rise as high as when performing the same operation with the selector lever in the “N” (NEUTRAL) position.

Passing acceleration

To gain extra acceleration in “D” (DRIVE) position (when passing another vehicle) push

Electronically controlled 4WD system (if so equipped)

the accelerator to the floor. The CVT will automatically downshift.

NOTE

- In sports mode, downshifts do not take place when the accelerator is depressed all the way to the floor.

5

Waiting

For short waiting periods, such as at traffic lights, the vehicle can be left in selector lever position and held stationary with the service brake.

For longer waiting periods with the engine running, place the selector lever in the “N” (NEUTRAL) position and apply the parking brake, while holding the vehicle stationary with the service brake.

Prior to moving off after having stopped the vehicle, make sure that the selector lever is in “D” (DRIVE) position or Sports mode position.

CAUTION

- To avoid transmission overheating, never try to keep your vehicle stationary on a hill by using the accelerator pedal. Always apply the parking brake and/or service brake.

CAUTION

- Do not rev the engine unnecessarily while the vehicle is stationary. Unexpected acceleration may occur if the selector lever is in a position other than “P” (PARK) or “N” (NEUTRAL).



Parking

To park the vehicle, first bring it to a complete stop, fully engage the parking brake, and then move the selector lever to the “P” (PARK) position.

When the CVT makes no speed change

If the CVT does not shift while driving, or your vehicle does not pick up enough speed when starting on an uphill slope, it may be that there is something unusual happening in the transmission, causing a safety device to activate. Immediately have your vehicle checked at an authorized Mitsubishi Motors dealer or a repair facility of your choice.

NOTE

- When the  warning display and “SLOW DOWN” or the  warning display and “SERVICE REQUIRED” appear on the information screen in the multi-information display, there could be a malfunction in the CVT. Refer to “Continuously variable transmission (CVT): Warning display” on page 5-54.

Electronically controlled 4WD system (if so equipped)

N00517201181

The electronically controlled 4WD system is an all-wheel drive system that allows one of three drive modes to be selected with a switch, in accordance with the driving conditions.

The following drive modes are available.

Drive mode	Function
2WD	This mode is for economical driving on normal dry roads and freeways. Driving in front-wheel drive.

Electronically controlled 4WD system (if so equipped)

Drive mode	Function
4WD AUTO	The default mode. This mode is for automatically controlling the distribution of driving torque to all four wheels according to the driving conditions.
4WD LOCK	This mode is for driving in slippery conditions such as on snow-covered roads or sand. The large amount of driving torque that is applied to the rear tires enables getting out of slippery areas and powerful driving is possible across all ranges.

4-wheel drive operation requires special driving skills. Carefully read the “4-wheel drive operation” section on page 5-60 and take care to drive safely.

Drive mode-selector

The drive mode can be changed by pressing the drive mode-selector while the ignition switch or the operation mode is in ON.

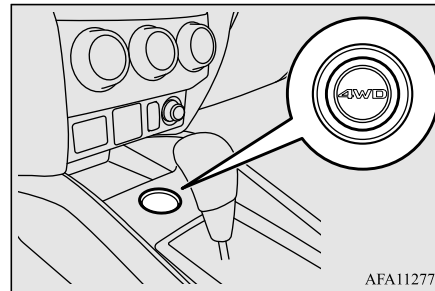

By pressing the drive mode-selector, the drive mode can be changed in order of “2WD”, “4WD AUTO” and “4WD LOCK”.

The drive mode is displayed as an interrupt display on the information screen in the multi-information display when the drive mode is changed.

After a few seconds, the information screen will then return to its prior display.

Drive mode	Display	
	Type 1	Type 2
2WD		
4WD AUTO		
4WD LOCK		

5

CAUTION

- Do not operate the drive mode-selector with the front wheels spinning on a snowy road or in similar conditions. The vehicle could lunge in an unexpected direction.
- Driving on dry, paved roads in “4WD LOCK” mode causes increased fuel consumption, noise, and premature tire wear.
- Do not drive with the tires spinning in “2WD” mode. Doing so could generate heat in the drive-system components.

NOTE

- The drive mode can be switched while driving or stopped.

4-wheel drive operation

Drive mode indicator

Type 1

4WD LOCK

5

Type 2

**4WD
LOCK**

Normally the indicator illuminates when the ignition switch is turned to the “ON” position or the operation mode is put in ON, and then the drive mode is displayed a few seconds after the engine is started.

Drive Mode	Drive mode indicator	
	“4WD” indicator	“LOCK” indicator
2WD	OFF	OFF
4WD AUTO	ON	OFF
4WD LOCK	ON	ON

CAUTION

- If the selected drive mode indicator is blinking, the vehicle switches automatically to front-wheel drive in order to protect the drive-system components, and drive mode selection is no longer possible with the drive mode-selector.
The warning display is also displayed in the information screen in the multi-information display.
Reduce speed, and if the indicator goes out after driving a while, resume driving as before.

Type 1

SLOW DOWN

Type 2

**4WD SYSTEM
OVERHEATING
SLOW DOWN**

CAUTION

- The warning display on the information screen in the multi-information display, a problem has occurred with the electronically controlled 4WD system and the safety device has activated. Immediately have your vehicle inspected by an authorized Mitsubishi Motors dealer or a repair facility of your choice.

Type 1

**SERVICE
REQUIRED**

Type 2

**4WD SYSTEM
SERVICE
REQUIRED**

CAUTION

- Always use tires of the same size, type, and brand that have no wear differences. Using tires that differ in size, type, brand, or wear amount may activate the protection of the drive-system components, causing the drive mode in “4WD AUTO” mode to lock or the “4WD” and “LOCK” indicators to blink alternately.

4-wheel drive operation

N00530601195

Your vehicle has been designed primarily for use on pavement.

But its unique 4-wheel drive system allows you to occasionally travel on unpaved roads, to campgrounds, picnic sites, and similar locations.

Not only does this ensure better handling on dry, paved roads but also permits better traction when driving on slippery, wet or snow-covered roads and when moving out of mud.

4-wheel drive operation

But it is not suitable for heavy off road use or towing in rough conditions.

It is particularly important to note that 4-wheel drive may not give sufficient hill climbing ability and engine braking on steep slopes. You should try to avoid driving on steep slopes.

Also, you must exercise caution when driving on sand and mud and when driving through water because sufficient traction may not be available in certain circumstances.

Please avoid driving the vehicle through areas where the tires may get stuck in deep sand or mud.

WARNING

- **Do not over-rely on the 4-wheel drive vehicles. Even 4-wheel drive vehicles have limits to the system and ability to maintain control and traction. Reckless driving may lead to accidents. Always drive carefully, taking account of the road conditions.**
- **Improperly operating this vehicle on or off-pavement can cause an accident or rollover in which you and your passengers could be seriously injured or killed.**
 - Follow all instructions and guidelines in the owner's manual.
 - Keep your speed low and do not drive faster than conditions.

NOTE

- Driving on rough roads can be hard on a vehicle. Before you leave the pavement, be sure all scheduled maintenance and service has been done, and that you have inspected your vehicle. Pay special attention to the condition of the tires, and check the tire pressures.
- Mitsubishi Motors is not responsible to the operator for any damage or injury caused or liability incurred by improper and negligent operation of a vehicle. All techniques of vehicle operation depend on the skill and experience of the operator and other participating parties. Any deviation from the recommended operating instructions above is at their own risk.
- Note that the stopping distance required of the 4-wheel drive vehicle differs very little from that of the front-wheel drive vehicle. When driving on a snow-covered road or a slippery, muddy surface, make sure that you keep a sufficient distance between your vehicle and the one ahead of you.
- The driving posture should be more upright; adjust the seat to a good position for easy steering and pedal operation. Be sure to wear the seat belt.
- After driving on rough roads, check each part of the vehicle and wash it thoroughly with water. Refer to the "Inspection and maintenance following rough road operation" section and "Vehicle care and Maintenance" sections.

CAUTION

- Setting the drive mode-selector to "4WD LOCK" position to drive on dry paved road will increase fuel consumption, with possible noise generation.

Turning sharp corners**5**

When turning a sharp corner in "4WD LOCK" position at low speed, a slight difference in steering may be experienced similar to feeling as if the brakes were applied. This is called tight corner braking and results from each of the four tires being at a different distance from the corner. The phenomenon is typical of 4-wheel drive vehicles. If this occurs, either straighten out the steering wheel or change to another mode.

On snowy or icy roads

Set the drive mode-selector to "4WD AUTO" or "4WD LOCK" in accordance with the road conditions, and then gradually depress the accelerator pedal for a smooth start.

NOTE

- The use of snow tires is recommended.

4-wheel drive operation

NOTE

- Maintain a safe distance between vehicles, avoid sudden braking, and use engine braking (downshifting).

5

CAUTION

- Avoid sudden braking, sudden acceleration and sharp turning. Skidding occurs and control of the vehicle could be lost.

Driving on sandy or muddy roads



Set the drive mode-selector to “4WD LOCK” and then gradually depress the accelerator pedal for a smooth start. Keep the pressure on the accelerator pedal as constant as possible, and drive at low speed.

CAUTION

- Do not force the vehicle or drive recklessly on sandy surfaces. In comparison with normal road surfaces, the engine and other drive-system components are put under excessive strain when driving on such a surface. This could lead to accidents.
- If any of the following conditions occur while the vehicle is being driven, immediately park your vehicle in a safe place and follow these procedures:

5-62 Features and controls

CAUTION

- If the engine coolant temperature display  flashes on the information screen in the multi-information display or the engine power drops suddenly. Refer to “Engine overheating” on page 8-4.
- If the  warning display and “SLOW DOWN” or the  warning display and “SERVICE REQUIRED” appear on the information screen in the multi-information display. Refer to “Warning display” on page 5-54.

WARNING

- **When attempting to rock your vehicle out of a stuck position, be sure that the area around the vehicle is clear of people and physical objects. The rocking motion may cause the vehicle to suddenly launch forward/backward, causing injury or damage to nearby people or objects.**

NOTE

- Avoid sudden braking, sudden acceleration and sharp turning; such operations could result in the vehicle becoming stuck.

NOTE

- If the vehicle becomes stuck in sandy or muddy roads, it can often be moved with a rocking motion. Move the gearshift lever alternately between the 1st and “R” (Reverse) positions (M/T), the “D” (DRIVE) and “R” (REVERSE) positions (CVT), while pressing lightly on the accelerator pedal.
- Driving on rough road can cause rust on the vehicle; wash the vehicle thoroughly as soon as possible after such use.

Climbing/descending sharp grades

Your vehicle may not provide sufficient hill climbing ability and engine braking on steep slope. Avoid driving on steep slopes even though the vehicle is an 4-wheel drive vehicle.

Driving through water

N00537800098

If the electrical circuits become wet, further operation of the vehicle will be impossible; therefore, avoid driving through water unless absolutely necessary. If driving through water is unavoidable, use the following procedure:

Check the depth of the water and the terrain before attempting to drive through it. Drive

Inspection and maintenance following rough road operation

slowly to avoid creating excessive water splashing.

CAUTION

- Never drive through water that is deep enough to cover wheel hubs, axles or exhaust pipe. Do not change the gearshift lever position (M/T) or the selector lever position (CVT) while driving through water. Frequent driving through water can adversely affect the life span of the vehicle; consult an authorized Mitsubishi Motors dealer or a repair facility of your choice and take the necessary measures to prepare, inspect, and repair the vehicle.
- After driving through water, apply the brakes to be sure they are functioning properly. If the brakes are wet and not functioning properly, dry them out by driving slowly while lightly depressing the brake pedal. Inspect each part of the vehicle carefully.

Inspection and maintenance following rough road operation

N00530700098

After operating the vehicle in rough road conditions, be sure to perform the following inspection and maintenance procedures:

- Check that the vehicle has not been damaged by rocks, gravel, etc.
- Carefully wash the vehicle with water. Drive the vehicle slowly while lightly depressing the brake pedal in order to dry out the brakes. If the brakes still do not function properly, contact an authorized Mitsubishi Motors dealer or a repair facility of your choice as soon as possible to have the brakes checked.
- Remove the insects, dried grass, etc. clogging the radiator core.
- After driving through water, check the engine, transaxle and differential oil. If the oil or grease is milky or cloudy because of water contamination, it must be replaced with new oil.
- Check the inside of the vehicle. If water entry is found, dry the carpet etc.
- Inspect the headlights. If water is in the headlight housing, have it drained at an authorized Mitsubishi Motors dealer or a repair facility of your choice.
- Have an authorized Mitsubishi Motors dealer replace grease in the wheel bearings.

Cautions on the handling of 4-wheel drive vehicles

N00530800187

Tires and wheels

5

Since the driving torque can be applied to the four wheels, the driving performance of the vehicle when operating in 4-wheel drive is greatly affected by the condition of the tires.

Pay close attention to the tires.

- Install only the specified tires on all wheels. Refer to “Tires and wheels” on page 11-5.
- Be sure all four tires and wheels are the same size and type. When it is necessary to replace any of the tires or wheels, replace all four.
- All tires should be rotated before the wear difference between the front and rear tires is recognizable.

Good vehicle performance cannot be expected if there is a difference in wear between tires. Refer to “Tire rotation” on page 9-19.

- Check the tire inflation pressure regularly.

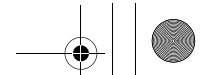

Service brake

5

CAUTION

- Always use tires of the same size, type, and brand that have no wear differences. Using tires of different size, type, brands or degree of wear, will increase the differential oil temperature and result in possible damage to the driving system. Further, the drive train will be subject to excessive loading, possibly leading to oil leakage, component seizure, or other serious failures.

CAUTION

- Do not tow 4-wheel drive vehicles with the front or rear wheels on the ground (Type A or Type B) as illustrated. This could result in damage to the drivetrain, or unstable towing. If you tow 4-wheel drive vehicles, use Type C or Type D equipment.
- Even in "2WD" mode, the vehicle cannot be towed with the front or the rear wheels on the ground.

When driving down a long or steep hill, use engine braking by downshifting.

WARNING

- Do not leave any objects near the brake pedal or let a floor mat slide under it; doing so could prevent the full pedal stroke that would be necessary in an emergency. Make sure that the pedal can be operated freely at all times. Make sure the floor mat is securely held in place.

Towing

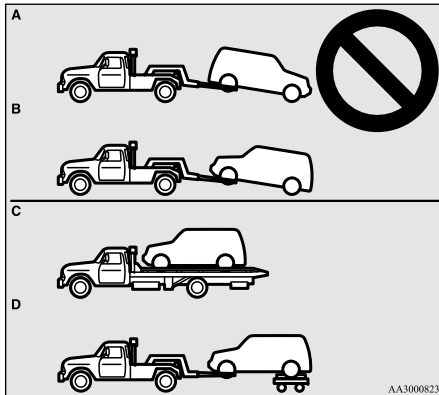

Jacking up a 4-wheel drive vehicle

WARNING

- Do not crank the engine while jacking up the vehicle. The tire on the ground may turn and the vehicle may roll off the jack.

Service brake

N00517500275

Brake pedal

Overuse of the brake can cause weakening, resulting in poor brake response and premature wear of the brake pads.

CAUTION

- It is important not to drive the vehicle with your foot resting on the brake pedal when braking is not required. This practice can result in very high brake temperatures, premature lining wear, and possible damage to the brakes.

Power brakes

N00517600436

Your vehicle is equipped with power brakes for more braking force with less brake pedal effort.

Your brakes are designed to operate at full capacity, even if the power assist is not being used.

If the power assist is not being used, the effort needed to press the brake pedal is greater.

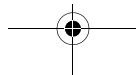

Hill start assist

If you should lose the power assist for some reason, the brakes will still work.

If the power brake unit or either of the two brake hydraulic systems stops working properly, the rest of the brake system will still work, but the vehicle will not slow down as quickly.

You will know this has happened if you find you need to press the brake down farther, or harder when slowing down or stopping, or if the brake warning light and the warning display in the multi-information display come on. Have the brake system repaired at an authorized Mitsubishi Motors dealer or a repair facility of your choice immediately.

WARNING

- **Never coast downhill with the engine OFF. Keep the engine running whenever your vehicle is in motion. If you turn off the engine while driving, the power brake booster will stop working and your brakes will not work as well.**
- **If the power assist is lost or if either brake hydraulic system stops working properly, take your vehicle to an authorized Mitsubishi Motors dealer or a repair facility of your choice immediately.**

Brake pad wear alarm

N00550700124

The disc brakes have an alarm that makes a metallic squeal when the brake pads have worn down enough to need service.

If you hear this sound, have the brake pads replaced at an authorized Mitsubishi Motors dealer or a repair facility of your choice.

WARNING

- **Driving with worn brake pads will make it harder to stop, and can cause an accident.**

Hill start assist

N00562600074

The hill start assist makes it easy to start off on a steep uphill slope by preventing the vehicle from moving backwards. It keeps the braking force for about 2 second when you move your foot from the brake pedal to the accelerator pedal.

CAUTION

- Do not overly rely on the hill start assist to prevent backwards movement of the vehicle. Under certain circumstances, even when hill start assist is activated, the vehicle may move backwards if the brake pedal is not sufficiently depressed, if the vehicle is heavily loaded, or if the road is very steep or slippery.
- The hill start assist is not designed to keep the vehicle stopped in place on uphill slopes for more than 2 seconds.
- When facing uphill, do not rely on using the hill start assist to maintain a stopped position as an alternative to depressing the brake pedal. Doing so could cause an accident.
- Do not perform the following operation while the hill start assist is operating. [Except for vehicles equipped with the F.A.S.T.-key]
Turn the ignition switch to the "OFF" or "ACC" position.
[Vehicles equipped with the F.A.S.T.-key]
Put the operation mode in OFF or ACC. The hill start assist could stop operating, which could result in an accident.

5**To operate**

N00562700059

1. Stop the vehicle completely using the brake pedal.

Hill start assist

2. On vehicles equipped with manual trans-axle, place the gearshift lever into the 1st positon.

On vehicles equipped with a continuously variable transmission (CVT), place the selector lever into the “D” position.

5

NOTE

- When reversing on an uphill slope, place the gearshift lever or the selector lever into the “R” position.

3. Release the brake pedal and the hill start assist will maintain the braking force applied while stopping for approximately 2 seconds.

4. Depress the accelerator pedal and the hill start assist gradually will decrease the braking force as the vehicle starts moving.

NOTE

- The hill start assist is activated when all of the following conditions are met.
 - The engine is running.
(The hill start assist will not be activated while the engine is starting or immediately after the engine is started.)

NOTE

- On vehicles equipped with manual trans-axle, the gearshift lever is in the following position.
[When starting an uphill slope forwards.]
The gearshift lever is in any position other than “R”.
(The hill start assist will operate, even if the gearshift lever is in the “N” position.)
[When starting an uphill slope backwards.]
The gearshift lever is in the “R” position.
(The hill start assist will not operate when the gearshift lever is in the “N” position.)
- On vehicles equipped with CVT, the selector lever is in any position other than “P” or “N”.
- The vehicle is completely stationary, with the brake pedal depressed.
- The parking brake is released.
- The hill start assist will not operate if the accelerator pedal is depressed before the brake pedal is released.
- The hill start assist also operates when reversing on an uphill slope.

Warning display

N00562800050

If an abnormal condition occurs in the system, the following display/indicator will turn on.

 - ASC indicator

Warning display type 1



Warning display type 2



NOTE

- The combination of items shown on the display varies depending on the vehicle model.

CAUTION

- If the warning is displayed, the hill start assist will not operate. Start off carefully.
- Park your vehicle in a safe place and stop the engine.
Restart the engine and check whether the indicator/display goes out, in which case the hill start assist is again working normally.
If they remain displayed or reappear frequently, it is not necessary to stop the vehicle immediately, but the vehicle should be inspected by an authorized Mitsubishi Motors dealer or a repair facility of your choice as soon as possible.

Brake assist system

Brake assist system

N00567301103

The brake assist system is a device assisting drivers who cannot depress the brake pedal firmly such as in emergency stop situations and provides greater braking force.

If the brake pedal is depressed suddenly, the brakes will be applied with more force than usual.

CAUTION

- The brake assist system is not a device designed to exercise braking force greater than its capacity. Make sure to always keep a sufficient distance between vehicles in front of you without relying too much on the brake assist system.

NOTE

- Once the brake assist system is operational, it maintains great braking force even if the brake pedal is lightly released. To stop its operation, completely remove your foot from the brake pedal.

NOTE

- When the brake assist system is in use while driving, you may feel as if the depressed brake pedal is soft, the pedal moves in small motions in conjunction with the operation noise, or the vehicle body and the steering wheel vibrate. This occurs when the brake assist system is operating normally and does not indicate faulty operation. Continue to depress the brake pedal.
- You may hear an operation noise when the brake pedal is suddenly or fully depressed while stationary. This does not indicate a malfunction and the brake assist system is operating normally.
- When the anti-lock brake system warning light/display or only ASC warning display illuminate, the brake assist system is not functioning.

Anti-lock braking system

N00517900240

The anti-lock braking system helps prevent the wheels from locking up when braking. This helps maintain vehicle drivability and steering wheel handling.

Driving hints

- When using the anti-lock brakes (sudden braking), steering is slightly different from normal driving conditions. Use the steering wheel carefully.
- Always keep a safe distance from the vehicle in front of you. Even if your vehicle is equipped with the anti-lock braking system, leave a greater braking distance when:
 - Driving on gravel or snow-covered roads.
 - Driving on uneven road surfaces.
- Operation of anti-lock braking system is not restricted situations where brakes are applied suddenly. This system may also prevent the wheels from locking when you drive over manholes, steel roadwork plates, road markings, or any uneven road surface.
- When the anti-lock braking system is in use, you may feel the brake pedal vibrating and hear a unique sound. It may also feel as if the pedal resists being pressed. **In this situation, simply hold the brake pedal down firmly. Do not pump the brake, which will result in reduced braking performance.**

5

Anti-lock braking system

5

⚠ CAUTION

- The anti-lock braking system cannot prevent accidents. It is your responsibility to take safety precautions and to drive carefully.
- To prevent failure of the anti-lock braking system, be sure all 4 wheels and tires are the same size and the same type.

📖 NOTE

- A whining sound is emitted from the engine compartment when driving immediately after starting the engine. These are the normal sounds the anti-lock braking system makes when performing a self-check. It does not indicate a malfunction.
- The anti-lock braking system can be used after the vehicle has reached a speed over approximately 6 mph (10 km/h). It stops working when the vehicle slows below 3 mph (5 km/h).

Anti-lock braking system warning light/display

N00531600645

Warning light



Warning display type 1



Warning display type 2



If there is a malfunction in the system, the anti-lock braking system warning light will come on and the warning display will appear on the information screen in the multi-information display.

Under normal conditions, the ABS warning light only comes on when the ignition switch is turned to the "ON" position or the operation mode is put in ON and goes off a few seconds later.

⚠ CAUTION

- Any of the following indicates that the anti-lock braking system is not functioning and only the standard brake system is working. (The standard brake system is functioning normally.) If this happens, take your vehicle to an authorized Mitsubishi Motors dealer or a repair facility of your choice.

⚠ CAUTION

- When the ignition switch is turned to the "ON" position or the operation mode is put in ON, the warning light does not come on or it remains on and does not go off.
- The warning light comes on while driving
- The warning display appears while driving

If the warning light/display illuminate while driving

N00531701643

If only the anti-lock braking system warning light/display illuminate

- Avoid hard braking and high-speed driving. Stop the vehicle in a safe place.

Test the system by restarting the engine and driving at a speed of about 12 mph (20 km/h) or higher.

If the warning light/display then remains off during driving, there is no abnormal condition.

However, if the warning light/display do not disappear, or if they come on again when the vehicle is driven, have the vehicle checked by an authorized Mitsubishi Motors dealer or repair facility of your choice as soon as possible.

If the anti-lock braking system warning light/display and brake warning light/display illuminate at the same time

Warning light



Warning display type 1



Warning display type 2

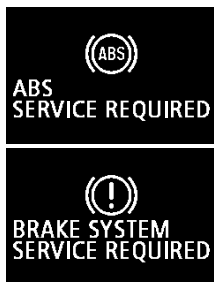

The anti-lock braking system and brake force distribution function may not work, so hard braking could make the vehicle unstable. Avoid hard braking and high-speed driving. Stop the vehicle in a safe place and contact an authorized Mitsubishi Motors dealer or repair facility of your choice.

NOTE

- The anti-lock braking system warning light and brake warning light illuminate at the same time and the warning displays appear alternately on the information screen in the multi-information display.

After driving on icy roads

N00529200077

After driving on snow or icy roads, remove any snow and ice which may have be left around the wheels. On vehicles that have an anti-lock braking system, be careful not to damage the wheel speed sensors (A) or the cables located at each wheel.

Electric power steering system (EPS)

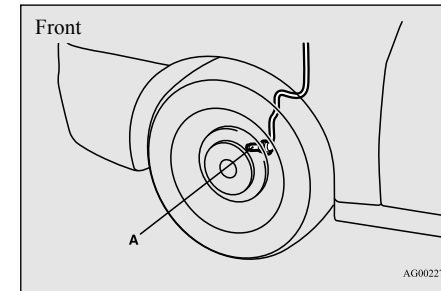

AG0022790

5

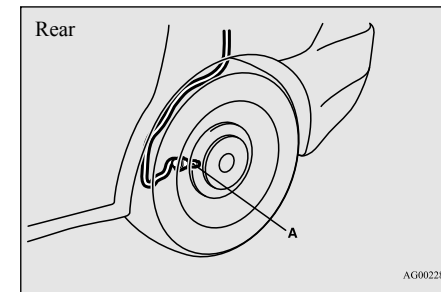

AG0022804

Electric power steering system (EPS)

N00568400061

The power steering system operates while the engine is running. It helps reduce the effort needed to turn the steering wheel. The power steering system has mechanical steering capability in case the power assist is

Features and controls 5-69

Active stability control (ASC)

lost. If the power assist is lost for some reason, you will still be able to steer your vehicle, but you will notice it takes much more effort to steer. If this happens, have your vehicle inspected at an authorized Mitsubishi Motors dealer or a repair facility of your choice.

5

WARNING

- Do not stop the engine while the vehicle is moving. Stopping the engine would make the steering wheel extremely hard to turn, possibly resulting in an accident.

NOTE

- During repeated full-lock turning of the steering wheel (for example, while you are manoeuvring the vehicle into a parking space), a protection function may be activated to prevent overheating of the power steering system. This function will make the steering wheel gradually harder to turn. In this event, limit your turning of the steering wheel for a while. When the system has cooled down, the steering effort will return to normal.
- If you turn the steering wheel while the vehicle is stationary with the headlights on, the headlights may become dim. This behavior is not abnormal. The headlights will return to their original brightness after a short while.

Electric power steering system warning display

Type 1



Type 2



If there is a malfunction in the system, the warning display will appear on the information screen in the multi-information display.

CAUTION

- If the warning display appears while the engine is running, have the vehicle inspected by an authorized Mitsubishi Motors dealer or a repair facility of your choice as soon as possible. It may become harder to turn the steering wheel.

Active stability control (ASC)

N00559100134

The Active stability control (ASC) takes overall control of the anti-lock braking system, traction control function and skid control function to help maintain the vehicle's control and traction. Please read this section in conjunction with the page on the anti-lock braking system, traction control function and skid control function.

Anti-lock braking system → P.5-67

Traction control function → P.5-71

Skid control function → P.5-71

CAUTION

- Do not over-rely on the ASC. Even the ASC cannot prevent the natural laws of physics from acting on the vehicle. This system, like any other system, has limits and cannot help you to maintain traction and control of the vehicle in all circumstances. Reckless driving can lead to accidents. It is the driver's responsibility to drive carefully, This means taking into account the traffic, road and environmental conditions.
- Be sure to use the same specified type and size of tire on all four wheels. Otherwise, the ASC may not work properly.

Active stability control (ASC)

CAUTION

- Do not install any aftermarket limited slip differential (LSD) on your vehicle. The ASC may stop functioning properly.

NOTE

- An operation noise may be emitted from the engine compartment in the following situations. The sound is associated with checking the operations of the ASC. At this time, you may feel a shock from the brake pedal if you depress it. These do not indicate a malfunction.
 - When the ignition switch is turned to the "ON" position or the operation mode is put in ON.
 - When the vehicle is driven for a while after the engine is turned on.
- When the ASC is activated, you may feel a vibration in the vehicle body or hear a whining sound from the engine compartment. This indicates that the system is operating normally. It does not indicate a malfunction.
- When the anti-lock braking system warning light is illuminated, the ASC is not active.

Traction control function

N00559200076

On slippery surfaces, the traction control function prevents the drive wheels from spinning excessive, thus helping the vehicle to

start moving from a stopped condition. It also provides sufficient driving force and steering performance as the vehicle turns while pressing the acceleration pedal.

CAUTION

- When driving a vehicle on a snowy or icy road, be sure to install snow tires and drive the vehicle at moderate speeds.

Skid control function

N00559300051

The skid control function is designed to help the driver maintain control of the vehicle on slippery roads or during rapid steering maneuvers. It works by controlling the engine output and the brake on each wheel.



NOTE

- The skid control function operates at speeds of about 9 mph (15 km/h) or higher.

ASC OFF switch

N00559401323

The ASC is automatically activated when the ignition switch is turned to the "ON" position or the operation mode is put in ON. You can deactivate the system by pressing down the "ASC OFF" switch for 3 seconds or longer.

When the ASC is deactivated, the  display/indicator will turn on. To reactivate the ASC, momentarily press the "ASC OFF" switch; the  display/indicator is turned off.

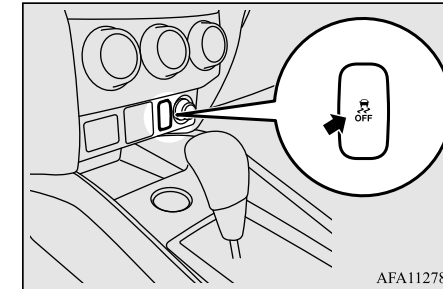

5

CAUTION

- For safety reasons, the "ASC OFF" switch should be operated when your vehicle is stopped.
- Be sure to keep the ASC on while driving in normal circumstances.

NOTE

- Using the "ASC OFF" switch turns off both the stability control function and the traction control function.

Active stability control (ASC)



5

NOTE

- When moving out of mud, sand or fresh snow, pressing the accelerator pedal may not allow the engine speed to increase. In such situations, temporarily turning off ASC with the “ASC OFF” switch will make it easier to move out your vehicle.
- If you continue to press the “ASC OFF” switch after the ASC is turned off, the “mistaken operation protection function” will activate and the ASC will turn back on.

ASC operation display or ASC OFF display



N00546500075

-  - ASC operation display/ASC indicator
The display/indicator will blink when the ASC is operating.
-  - ASC OFF display/ASC OFF indicator
This display/indicator will turn on when the ASC is turned off with the “ASC OFF” switch.

NOTE

- The combination of items shown on the display varies depending on the vehicle model.

CAUTION

- When  display/indicator blinks, ASC is operating, which means that the road is slippery or that your vehicle’s wheels are beginning to slip. If this happens, drive slower with less accelerator input.
- If the temperature in the braking system continues to increase due to continuous brake control on a slippery road surface, the  display/indicator will blink. To prevent the brake system from overheating, the brake control of the traction control function will be temporarily suspended. The engine control of the traction control function and normal brake operation will not be affected. Park your vehicle in a safe place. When the temperature in the braking system has come down, the  display/indicator will be turned off and the traction control function will start operating again.

NOTE

- The  display/indicator may turn on when you start the engine. This means that the battery voltage momentarily dropped when the engine was started. It does not indicate a malfunction, provided that the display goes out immediately.



NOTE

- When a compact spare tire has been put on your vehicle, the gripping ability of the tire will be lower, making it more likely that the  display/indicator will blink.

ASC warning display

N00546600076

If an abnormal condition occurs in the system, the following display/indicator will turn on.

-  - ASC indicator
-  - ASC OFF display/ASC OFF indicator

Warning display type 1



Warning display type 2



Cruise control (if so equipped)

NOTE

- The combination of items shown on the display varies depending on the vehicle model.

CAUTION

- The system may be malfunctioning. Park your vehicle in a safe place and stop the engine. Restart the engine and check whether the display/indicator goes out. If they go out, there is no abnormal condition. If they do not go out or appear frequently, it is not necessary to stop the vehicle immediately, but you should have your vehicle inspected by an authorized Mitsubishi Motors dealer or a repair facility of your choice as soon as possible.

Towing

N00546300031

CAUTION

- When towing the vehicle with only the front wheels or only the rear wheels raised off the ground, do not place the ignition switch in the “ON” position or do not put the operation mode in ON. Placing the ignition switch in the “ON” position or putting the operation mode in ON could cause the ASC to operate, resulting in an accident. Note that the correct towing method depends on the transmission type and the vehicle’s drive configuration. For details, refer to “Towing” on page 8-12.

Cruise control (if so equipped)

N00518301600

Cruise control is an automatic speed control system that keeps a set speed. It can be activated at speeds from about 25 mph (40 km/h). Cruise control does not work at speeds below about 25 mph (40 km/h).

CAUTION

- When you do not wish to drive at a set speed, turn off the cruise control for safety.

CAUTION

- Do not use cruise control when driving conditions will not allow you to stay at the same speed, such as in heavy traffic or on roads that are winding, icy, snow-covered, wet, slippery, on a steep downhill slope.
- On vehicles equipped with manual transaxle, do not move the gearshift lever to the “N” (Neutral) position while driving at a set speed without depressing the clutch pedal. The engine will run too fast and might be damaged.

5

NOTE

- Cruise control may not be able to keep your speed on uphill or downhill.
- Your speed may decrease on a steep uphill. You may use the accelerator pedal if you want to stay at your set speed.
- Your speed may increase to more than the set speed on a steep downhill. You have to use the brake to control your speed. As a result, the set speed driving is deactivated.

Cruise control (if so equipped)

Cruise control switches

5

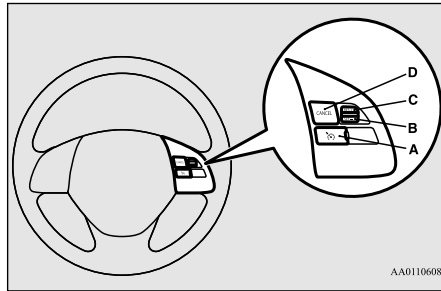

- A- CRUISE CONTROL ON/OFF switch**
Used to turn on and off the cruise control.
- B- SET - switch**
Used to reduce the set speed and to set the desired speed.
- C- RES + switch**
Used to increase the set speed and to return to the original set speed.
- D- CANCEL switch**
Used to deactivate the set speed driving.

NOTE

- When operating the cruise control switches, press the cruise control switches correctly. The set speed driving may be deactivated automatically if two or more switches of the cruise control are pressed at the same time.

To activate

N00518401409

1. With the ignition switch in “ON” position or the operation mode is in ON, press the CRUISE CONTROL ON/OFF switch (A) to turn on the cruise control. The “CRUISE” indicator light in the meter cluster will come on.

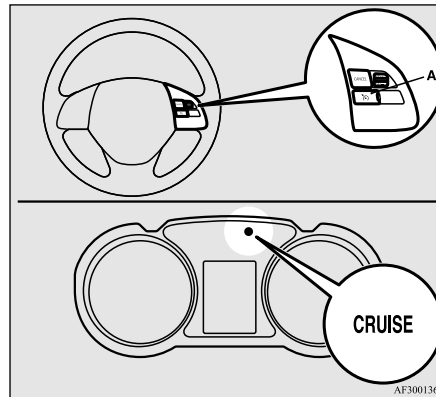

NOTE

- If the cruise control is on when the following operation is performed, cruise control will be on automatically the next time you start the engine. The “CRUISE” indicator light will also be on.
[Except for vehicles equipped with the F.A.S.T.-key]
Turn the ignition switch to the “OFF” or “ACC” position.
[Vehicles equipped with the F.A.S.T.-key]
Put the operation mode in OFF or ACC.
 - If the battery voltage is insufficient, the memory data for the cruise control may be erased.
As a result, the “CRUISE” indicator light may not come on when you restart the engine.
If this happens, press the CRUISE CONTROL ON/OFF switch once again to turn on the cruise control.
2. Accelerate or decelerate to your desired speed, then push down and release the SET - switch (B) when the “CRUISE” indicator light is illuminated. The vehicle will then maintain the desired speed.

Cruise control (if so equipped)

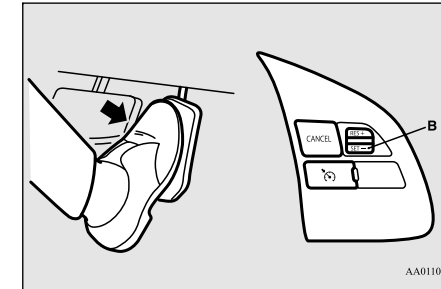
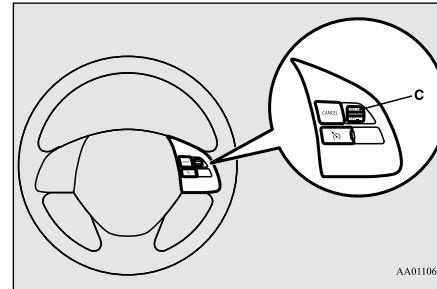
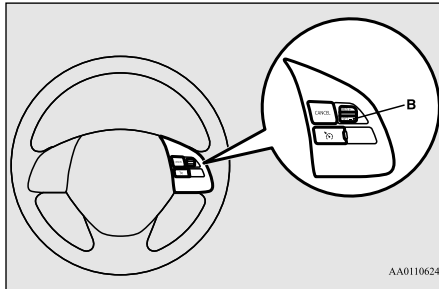

5

NOTE

- When you release the SET - switch, the vehicle speed will be set.

To increase the set speed

N00518501367

There are 2 ways to increase the set speed.

RES + switch

Push up and hold the RES + switch (C) while driving at the set speed, and your speed will then gradually increase.

When you reach your desired speed, release the switch. Your new cruising speed is now set.

To increase your speed in small amounts, push up the RES + switch for less than about 1 second and release it.

Each time you push up the RES + switch, your vehicle will go about 1 mph (1.6 km/h) faster.

Accelerator pedal

While driving at the set speed, use the accelerator pedal to reach your desired speed and then push down the SET - switch (B) and release the switch momentarily to set a new desired cruising speed.

To decrease the set speed

N00518601296

There are 2 ways to decrease the set speed.

SET - switch

Push down and hold the SET - switch (B) while driving at the set speed, and your speed will slow down gradually.

When you reach your desired speed, release the switch. Your new cruising speed is now set.

Cruise control (if so equipped)

5

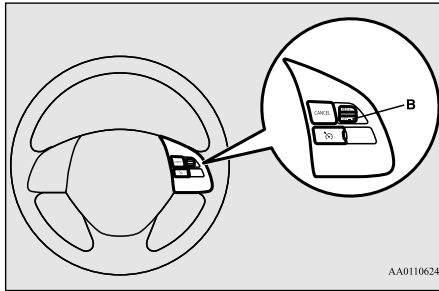

To slow down your speed in small amounts, push down the SET - switch for less than about 1 second and release it.

Each time you push down the SET - switch, your vehicle will slow down by about 1 mph (1.6 km/h).

Brake pedal

While driving at the set speed, use the brake pedal, which disengages the cruise control, then push down the SET - switch (B) and release the switch momentarily to set a new desired cruising speed.

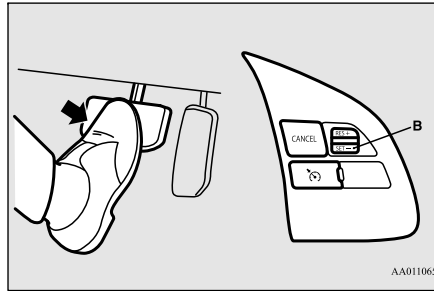

To temporarily increase or decrease the speed

N00541701079

To temporarily increase the speed

Depress the accelerator pedal as you would normally. When you release the pedal, you will return to your set speed.

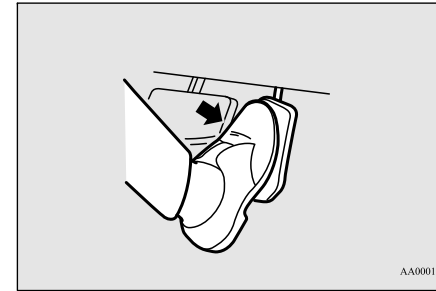

To temporarily decrease the speed

Depress the brake pedal to decrease the speed. To return to the previously set speed, push up the RES + switch (C). Refer to “To resume the set speed” on page 5-77.

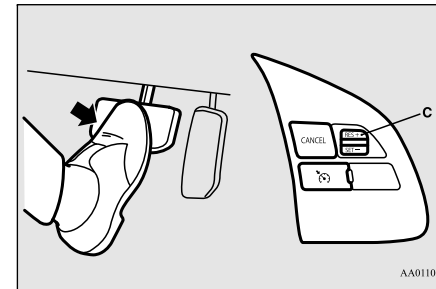

Cruise control (if so equipped)

To deactivate

N00518801591

The set speed driving can be deactivated as follows:

- Press the CRUISE CONTROL ON/OFF switch (A). (Cruise control will be turned off.)
- Press the CANCEL switch (D).
- Depress the brake pedal.

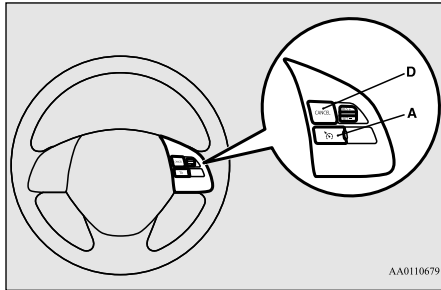

The set speed driving is deactivated automatically in any of the following ways.

- When you depress the clutch pedal (on vehicles equipped with manual transaxle).
- When your speed slows to about 10 mph (15 km/h) or more below the set speed because of a hill, etc.
- When your speed slows to about 25 mph (40 km/h) or less.

- When the active stability control (ASC) starts operating.
Refer to “Active stability control (ASC)” on page 5-70.

WARNING

- **On vehicles equipped with continuously variable transmission (CVT), although the set speed driving will be deactivated when shifting to the “N” (NEUTRAL) position, never move the selector lever to the “N” (NEUTRAL) position while driving. You would have no engine braking and could cause a serious accident.**

Also, the set speed driving may be deactivated as follows:

- When the engine speed rises and approaches the tachometer’s red zone (the red-colored part of the tachometer dial).

CAUTION

- When the set speed driving is deactivated automatically in any situation other than those listed above, there may be a system malfunction.
Press the CRUISE CONTROL ON/OFF switch to turn off the cruise control and have your vehicle inspected by an authorized Mitsubishi Motors dealer or a repair facility of your choice.

To resume the set speed

N00518901329

If the set speed driving is deactivated by any condition described in “To deactivate” on page 5-77, you can resume the previously set speed by pushing up the RES + switch (C) while driving at a speed of about 25 mph (40 km/h) or higher.

5

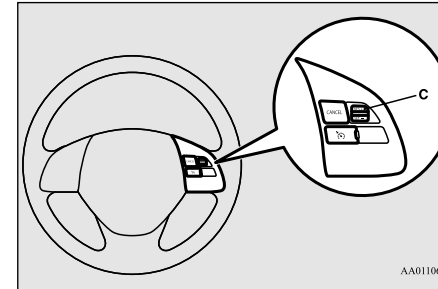

Under either of the following conditions, however, using the switch does not allow you to resume the previously set speed. In these situations, repeat the speed setting procedure:

- The CRUISE CONTROL ON/OFF switch is pressed.
- [Except for vehicles equipped with the F.A.S.T.-key]
Turn the ignition switch to the “OFF” or “ACC” position.
[Vehicles equipped with the F.A.S.T.-key]

Forward Collision Mitigation system (FCM) (if so equipped)

- Put the operation mode in OFF or ACC.
- “CRUISE” indicator light is turned OFF.

Forward Collision Mitigation system (FCM) (if so equipped)

5

N00577300082

The Forward Collision Mitigation system (FCM) is designed to help reduce the risk of a collision with a vehicle or a pedestrian straight ahead of your vehicle. The FCM uses a sensor (A) to determine the distance and relative speed to a vehicle and a pedestrian in front. The FCM is not designed as an automatic driving system or as a collision avoidance system.

When your vehicle is approaching a vehicle or a pedestrian straight-ahead in your path and the FCM judges that there is the risk of a collision, the system will give audible and visual warnings.

When the FCM judges that a collision with the vehicle or the pedestrian straight-ahead is imminent, the system will automatically apply moderate braking to warn you to apply the brakes immediately.

When the FCM judges that a collision with the vehicle or the pedestrian straight-ahead is highly unavoidable, the system will apply emergency braking to reduce the severity of

the collision and, if possible, to avoid the collision.

Stop lights are illuminated during automatic braking.

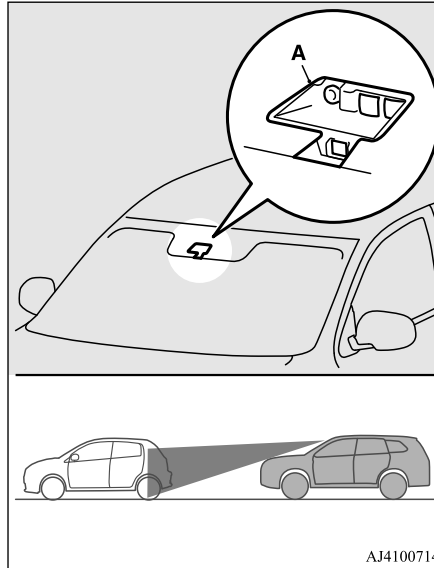

WARNING

- Before using the FCM, read this entire section to fully understand the limitations of this system. Failure to follow instructions could result in an accident.

WARNING

- The FCM is designed to help avoid certain frontal collisions or reduce the crash speed in such collisions. It is not a substitute for your safe and careful driving. Under certain circumstances, the system may not operate or may not detect correctly a vehicle or a pedestrian in front. When your vehicle is approaching a vehicle or a pedestrian too closely, take all necessary actions to avoid a collision, such as braking and steering, regardless of whether the FCM is activated or not. Never rely on the FCM to prevent a collision.
- Never attempt to test the operation of the FCM. Doing so could cause an accident, resulting in serious injury or death.

Forward Collision Mitigation system (FCM) (if so equipped)

Forward collision warning function

N00577400067

If the system judges that there is a risk of your vehicle colliding with a vehicle or the pedestrian in front, this function warns you of the potential hazard with visual and audible alarms.

When this function is triggered, a buzzer sounds and, at the same time, the  indicator flashes.

The FCM will also prepare to provide quick brake response and greater brake force when you apply the brakes.

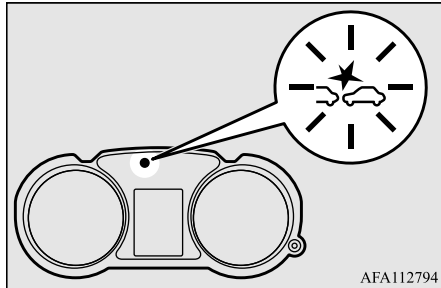

AFA112794

The forward collision warning function operates at the following vehicle speeds:

- Against a vehicle: Approximately 10 mph (15 km/h) to 87 mph (140 km/h).
- Against a pedestrian: Approximately 5 mph (7 km/h) to 40 mph (65 km/h).

FCM braking function

N00577700099

When the FCM judges that a collision with the vehicle or the pedestrian straight-ahead is imminent, the FCM will automatically apply moderate braking to warn the driver to apply the brakes immediately.

If the FCM judges that the collision is highly unavoidable, it will automatically apply emergency braking to reduce the severity of the collision and, if possible, to avoid the collision.

When the FCM applies emergency braking, a warning message is displayed in the information screen of the multi-information display.



The FCM braking function operates at the following vehicle speeds:

- Against a vehicle: Approximately 3 mph (5 km/h) to 50 mph (80 km/h)
- Against a pedestrian: Approximately 3 mph (5 km/h) to 40 mph (65 km/h)

WARNING

- If the ASC is turned off, the FCM braking function will not operate. Refer to “Active stability control” on page 5-70.
- If the brake pedal is not depressed within 2 seconds after your vehicle has been stopped by the FCM, a warning buzzer will sound and the brakes activated by the FCM will automatically be released. Apply the brakes as necessary to keep your vehicle stationary.
- The FCM will not activate and will not provide either warning or braking in certain situations. Some of these include:
 - On vehicles equipped with continuously variable transmission (CVT), when the selector lever is in the “P” (PARK) or “R” (REVERSE) position.
 - On vehicles equipped with manual trans-axle (M/T), when the gearshift lever is in the “R” (REVERSE) position.
 - When an object other than a vehicle or a pedestrian is in front.
 - When the FCM has detected a problem in the system.
 - When a vehicle or a pedestrian suddenly cuts in front of your vehicle.
- The FCM may or may not detect a motorcycle, bicycle or wall depending on the situation. The FCM is not designed to detect these objects.

Forward Collision Mitigation system (FCM) (if so equipped)

5

⚠ WARNING

- The forward collision warning function and/or the FCM braking function may not activate in certain situations. Some of these include:
 - When a vehicle suddenly appears just in front of your vehicle.
 - When a vehicle cuts into your path at a close distance.
 - When a vehicle ahead is not completely in your path.
 - When your vehicle changed lanes, and your vehicle approached immediately behind the vehicle ahead.
 - When a vehicle ahead is towing a trailer.
 - When a vehicle ahead is a truck loaded with freight that protrudes rearward from the cargo bed.
 - When the height of a vehicle ahead is extremely low or its road clearance is extremely high.
 - When a vehicle ahead is extremely dirty.
 - When a vehicle ahead is covered with snow.
 - When a vehicle ahead has a large glass surface.
 - When a vehicle ahead does not have reflectors (light reflector) or the position of the reflector is low.
 - When a vehicle ahead is a car carrier or a similar shaped vehicle.
 - When accelerating and decelerating quickly.

⚠ WARNING

- When driving on a slippery road covered by rain water, snow, ice, etc.
- When driving on a road with alternating up and down steep slopes.
- When driving on a curve.
- When driving on a bumpy or rough road.
- When driving in dark areas, such as in a tunnel or at night.
- When the system recognizes driver's steering, accelerating, braking or gear shifting actions as evasive actions to avoid collision.
- When the rear of your vehicle is weighed down with the weight of passengers and luggage.
- Up to several seconds after starting driving.
- In adverse weather conditions, such as rain, snow, fog or sand-storm.
- When the windshield of the sensor portion is covered with dirt, water droplets, snow and ice, etc.
- When a vehicle ahead or an oncoming vehicle is splashing water, snow or dirt.
- When using a windshield washer.
- If windshield wipers are not Mitsubishi Motors Genuine parts or equivalent.
- When the sensor becomes extremely hot or cold.
- If the battery becomes weak or runs down.

⚠ WARNING

- When the sensor is affected by strong light, such as direct sunlight or the headlights of an oncoming vehicle.
- The FCM may not detect a pedestrian in certain situations. Some of these include:
 - If the pedestrian is shorter than approximately 3.2 feet (1 m) or taller than approximately 6.5 feet (2 m).
 - If the pedestrian is wearing loose-fitting clothes.
 - If part of a pedestrian's body is hidden, such as when holding an umbrella, large bag, etc.
 - If a pedestrian bends forward, sits or lies on the road.
 - When a pedestrian is pushing/pulling something, such as a stroller, bicycle or wheelchair.
 - When pedestrians gather in a group.
 - When a pedestrian clothing appears to be nearly the same color or brightness as its surroundings.
 - When a pedestrian is very close to an object, such as a vehicle.
 - When a pedestrian is in a dark area, such as at night or in a tunnel.
 - When a pedestrian is walking fast or running.
 - When a pedestrian suddenly rushes in front of the vehicle.
 - When the position of a pedestrian is close to the edge of the vehicle.

Forward Collision Mitigation system (FCM) (if so equipped)

WARNING

- When the system recognizes driver's steering or accelerating actions as evasive actions to avoid a collision, FCM control and alarm functions may be canceled.
- In certain situations, though there is little or no risk of a collision, the FCM may activate. Examples include:
 - When overtaking a vehicle.
 - When driving on a curve.
 - When there is a road side object (B) that reflects the radar sensor signal, such as a road sign.

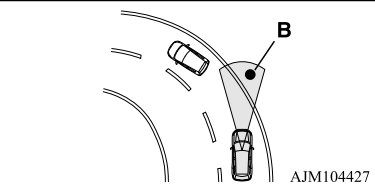

AJM104427

- When approaching a gate, a railroad crossing, an underpass, a narrow bridge, manhole lid or a speed bump.
- When driving under an overpass or pedestrian bridge.
- When driving in a narrow tunnel.
- When driving in a parking structure.
- When approaching a slope where the incline changes significantly.
- When trying to stop your vehicle very close to a vehicle or an object in front.

WARNING

- When passing a vehicle, a pedestrian or an object closely.

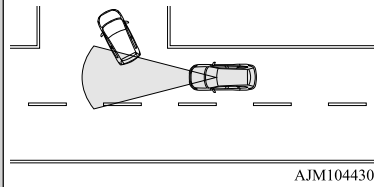

AJM104430

- When a vehicle in the next lane becomes positioned directly in front of your vehicle due to winding road conditions.

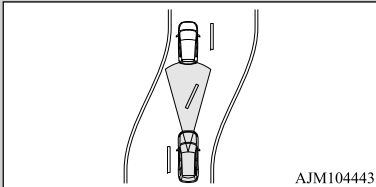

AJM104443

- When passing through an area that objects may contact the vehicle, such as thick grass, tree branches, or a banner.
- When there are patterns on the road that may be mistaken for a vehicle or a pedestrian.
- When a vehicle cuts into your path in the detecting range of the sensor.
- When an oncoming vehicle is positioned straight ahead of your vehicle on a curved road.

WARNING

- When the FCM detects a long object carried on your vehicle, such as skis or a roof carrier.
- When driving through fog, steam, smoke or dust.
- The FCM should be tuned off if any of the following situations occur:
 - When using an automatic car wash.
 - When the tires are not properly inflated.
 - When the emergency spare tire is used.
 - When your vehicle is towed or your vehicle tows another vehicle.
 - When your vehicle is carried on a truck.
 - When your vehicle is on a chassis dynamometer or free rollers.
 - If the windshield on or surrounding the sensor is cracked or scratched.

NOTE

- When depressing the brake pedal while automatic braking is applied, the brake pedal will feel firm. This is normal. Depress the brake pedal harder to apply greater braking force.
- During the automatic braking, operating sounds may be heard. This is normal.

Forward Collision Mitigation system (FCM) (if so equipped)

FCM ON/OFF switch

N00577800087

This switch is used to turn on or off the FCM, and also to select the distance which will trigger the forward collision warning function.

5

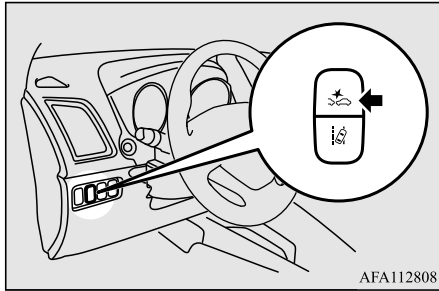

To turn on/off the FCM

Every time the operation mode is put in "ON", the FCM the ignition switch is turned to the "ON" position or the operation mode is put in ON, will automatically be turned on. To turn off the FCM, press and hold the FCM ON/OFF switch. The following message appears on the information screen of the multi-information display and the  indicator will come on in the instrument cluster.

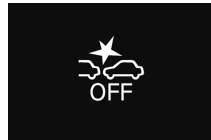

To turn on the FCM again, press the FCM ON/OFF switch. The  indicator on the instrument cluster will go off, and a current distance mode for the forward collision warning will be shown in the information screen of the multi-information display.

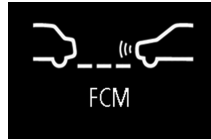

To change forward collision warning distance

The distance to the vehicle ahead which triggers the forward collision warnings can be selected from three levels (far, middle or near).

To change the distance mode, push the FCM ON/OFF switch. Every time the switch is pushed, the distance mode will be switched. The selected distance mode is shown on the information screen of the multi-information display.

Distance mode: Far

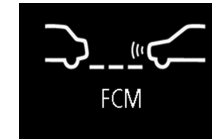

Distance mode: Middle

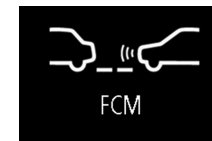

Forward Collision Mitigation system (FCM) (if so equipped)

Distance mode: Near



NOTE

- Actual distance which triggers the forward collision warnings will vary depending on your vehicle speed and the front vehicle speed. The distance will become longer when the vehicle speeds are higher.
- The distance which will trigger the FCM braking function cannot be adjusted.

System problem warning

N00593300051

If there is a malfunction in the system, a warning will appear on the information screen of the multi-information display depending on the situation.

Windshield is dirty

When the FCM system determines that its performance has been degraded, the FCM will become inoperative. This can occur when:

- Foreign objects, such as dirt, snow, ice, mist or dew condensation adhere to the windshield of the sensor portion.
- In adverse weather conditions, such as rain, snow, sand storms, etc.
- A front vehicle or an oncoming vehicle is splashing water, snow or dirt.

The following message will appear on the information screen of the multi-information display and the indicator will come on in the instrument cluster.



When the sensor performance returns, the FCM functions will resume operation. If the message continues showing, there is a possibility that the sensor has a malfunction. Contact an authorized Mitsubishi Motors dealer for inspection of the sensor.

NOTE

- The “CAMERA BLOCKED” message may temporarily appear on the information screen when the sensor cannot detect a vehicle, a pedestrian or an object within range. This is not a malfunction. When a vehicle or an object comes within range, the FCM function will resume and the message will go off.

NOTE

- The “CAMERA BLOCKED” message may appear on the information screen when driving on a nonbusy road with a few vehicles and obstacles in front.

When the system cannot operate temporarily

5

If the system becomes temporarily unavailable for some reason, the following message will appear on the information screen of the multi-information display, the indicator will come on in the instrument cluster, and the FCM will automatically be turned off.



If the message continues showing, there is a possibility that the FCM has a malfunction. Contact an authorized Mitsubishi Motors dealer for inspection of the system.

Forward Collision Mitigation system (FCM) (if so equipped)

Sensor is too hot or cold

If the system becomes temporarily unavailable due to the high or low temperature of the sensor, the following message will appear on the information screen of the multi-information display, the  indicator will come on in the instrument cluster, and the FCM will automatically be turned off.

5



After the temperature of the sensor has been in range, the system will automatically return to operation.

If the message continues showing, there is a possibility that the FCM has a malfunction. Contact an authorized Mitsubishi Motors dealer for inspection of the sensor.

FCM deactivation due to fault

If the FCM detects a malfunction in the system, either of the following messages will appear on the information screen of the multi-information display, the  indicator will come on in the instrument cluster, and the FCM will automatically be turned off.



If the message remains even after the ignition switch is turned to the "OFF" position and then turned back to "ON" position or the operation mode is put in OFF, and then turned back to "ON", please contact your authorized Mitsubishi Motors dealer.

NOTE

- If the sensor or its surrounding area becomes extremely hot (after prolonged exposure to direct sunlight, for example), the "FCM SERVICE REQUIRED" message may appear. After the temperature of the sensor or its surrounding area has been in range, if the message remains even after restarting the engine, please contact an authorized Mitsubishi Motors dealer.

Forward Collision Mitigation system (FCM) (if so equipped)

Handling of the sensor

N00593400065

The sensor (A) is located inside the windshield as shown in the illustration.

The sensor is shared in the following systems:

- Forward Collision Mitigation system (FCM)
- Lane Departure Warning (LDW)
- Automatic High Beam (AHB)

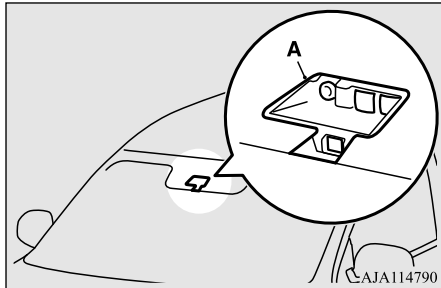

AJA114790

CAUTION

- To maintain proper performance of the FCM, LDW and AHB;
 - Always keep the windshield clean. If the inside of the windshield where the sensor is installed becomes dirty or fogged, contact an authorized Mitsubishi Motors dealer.

CAUTION

- Do not apply an impact or load on the sensor or its surrounding area.
- Do not put anything including a sticker or film on the windshield in front of or surrounding the area of the sensor.

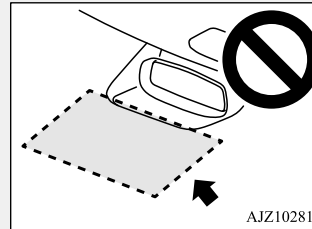

AJZ102815

- Do not attempt to detach or disassemble the sensor.
- If the windshield is misted, remove the mist from the windshield by using the defogger switch.
- Maintain the wiper blades in good condition. Refer to "Wiper blades" on page 9-44. When replacing the wiper blades, use only Mitsubishi Motors Genuine parts or equivalent.
- Do not dirty or damage the sensor.
- Do not spray glass cleaner on the sensor. Also, do not spill liquid, such as a beverage, on the sensor.
- Do not install an electronic device, such as an antenna, or a device that emits strong electric waves, near the sensor.

CAUTION

- Always use tires of the same size, same type and same brand, and which have no significant wear differences.
- Do not modify the vehicle's suspensions.
- If the windshield in front of the sensor or in the surrounding area of the sensor is cracked or scratched, the sensor may not detect an object properly. This could cause a serious accident. Turn off the FCM and have your vehicle inspected as soon as possible at an authorized Mitsubishi Motors dealer. If you need to replace the windshield, contact an authorized Mitsubishi Motors dealer.
- The sensor emits infrared rays when the operation mode is in ON. Do not look into the sensor by using optical goods such as a magnifying glass. The infrared ray might injure your eyes.

5

Laser radar specifications

Laser classification

Max average power	45 mW
Pulse duration	33 ns
Wavelength	905 nm
Divergent angle (horizon x vertical)	28° x 12°

Lane Departure Warning (LDW) (if so equipped)

Laser classification label

5

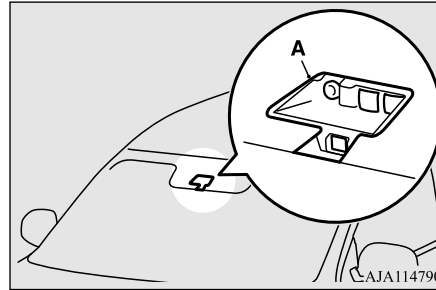

To turn on/off the LDW

N0057800060

NOTE

- The LDW is turned on when the vehicle is shipped from the factory.
- The currently selected LDW setting (on or off) is stored even when the ignition switch is turned to the "OFF" position or the operation mode is put in OFF.

Lane Departure Warning (LDW) (if so equipped)

N0057790075

The Lane Departure Warning (LDW) is a driving aid system to help prevent unintentional lane departure. The LDW is designed to read lane markers by using a sensor (A) under certain conditions. The LDW will give you both visual and audible warnings when your vehicle is leaving or has left the lane. For details about handling the sensor, refer to "Handling of the sensor" on page 5-85.

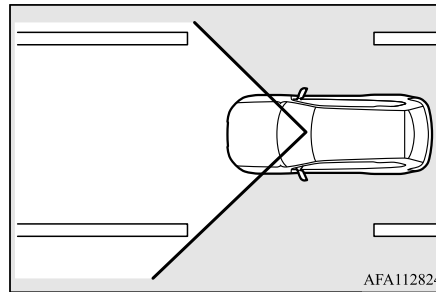

WARNING

- **Never rely solely on the LDW. The LDW is not a collision avoidance system and is not a substitute for your safe and careful driving.**
- **Before using the LDW, read this entire section to understand the limitations of this system. Failure to follow instructions could result in an accident.**

To turn on the LDW, press the LDW switch. The  indicator will appear on the information screen of the multi-information display.

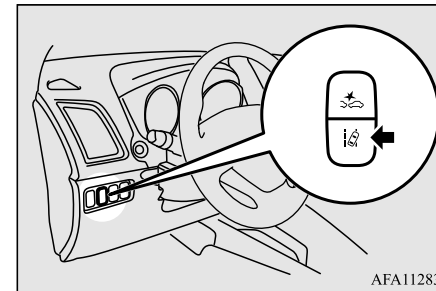

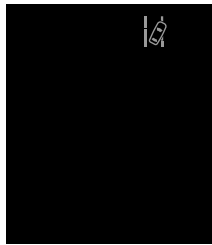

Lane Departure Warning (LDW) (if so equipped)



To turn off the LDW, press the LDW switch. The  indicator on the information screen of the multi-information display will then go out. To return the LDW to “ON”, press the LDW switch again.

Operation of the LDW

N00581100052



The LDW, when turned ON, is capable of recognizing the lane in which your vehicle is travelling and issuing an audible warning when your vehicle begins to leave that travel lane. When operating, the  indicator on the information screen in the multi-information display will be changed to green. However, the LDW will not operate in the following situations even if the  indicator appears:

- The vehicle speed is less than 38 mph (60 km/h).
- The turn signal lever is being operated or has been operated in the past 7 seconds.

- The hazard warning light is being operated or has been operated in the past 7 seconds.

Lane departure warning

N00581200079

While the  indicator on the information screen in the multi-information display is lit in green, if your vehicle is leaving or has left the lane, a buzzer will sound intermittently, and the  indicator will be flashing in yellow.

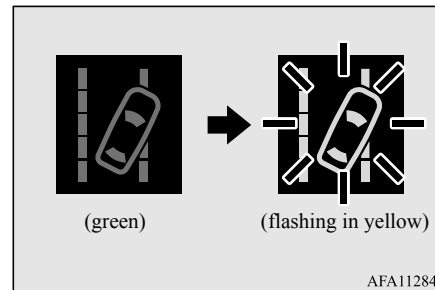

AFA112840

NOTE

- The warning will not continue for more than 3 seconds, even if your vehicle continues leaving the lane.

NOTE

- If the lane markers are only on one side of the road, the LDW will operate only for the appropriate side where the lane marker is drawn.

WARNING

5

- The LDW will not function when no lane marker exists, such as at an intersection or near a toll booth.
- The LDW may not operate correctly in the following situations and the LDW may not give warnings or may give false warnings:
 - When lane markers are not clearly visible due to rain, snow, fog, dark area, etc.
 - When the road surface is shiny.
 - When old lane markers remain on the road surface.
 - When the lane markers are double lines or the shape of the lane markers are complicated.
 - When driving in an extremely narrow lane.
 - When the distance between your vehicle and a vehicle in front is short.
 - When driving into the sun light.
 - When driving on curves.
 - When driving on bumpy roads.
 - When driving in construction zones.
 - When passing through a place where the brightness suddenly changes, such as at the entrance to or exit of a tunnel.

Lane Departure Warning (LDW) (if so equipped)

5

WARNING

- When the headlights of an oncoming vehicle are very bright.
- When the rear of your vehicle is weighed down with the weight of passengers and luggage.
- When the headlights of your vehicle are not clean or are not properly aimed.
- When the front windshield is not clean.
- When the front windshield wipers do not clean the windshield properly.

CAUTION

- To maintain proper function of the LDW:
 - Always keep the windshield and the headlights clean.
 - Do not put anything, such as a sticker, on the front windshield in front of the sensor.
 - Avoid applying a shock or load to the sensor.
 - Do not attempt to detach or disassemble the sensor.
 - Use only Mitsubishi Motors Genuine parts when replacing the windshield wipers.

NOTE

- When driving conditions are not suitable to use the LDW, turn off the LDW.

System problem warning

N00578100061

If a problem occurs with the system, a visual warning specific to the type of the problem is given together with an audible alarm.

Sensor is too hot or cold

The alarm shown below is displayed if the system becomes temporarily unavailable due to the high or low temperature of the sensor. After temperature of the sensor has been in range, the system will automatically return to operation.

If the alarm continues showing, there is a possibility that the LDW has a malfunction. Contact an authorized Mitsubishi Motors dealer for inspection of the system.



Windshield is dirty

The alarm shown below is displayed if the system becomes temporarily unavailable due to the dirty windshield of the sensor portion. After having cleaned the windshield, the system will automatically return to operation. If the alarm continues showing, there is a possibility that the LDW has a malfunction. Contact an authorized Mitsubishi Motors dealer for inspection of the sensor.



LDW deactivation due to fault

If the LDW is deactivated due to a malfunction in the system, the either alarm shown below is displayed. Contact your authorized Mitsubishi Motors dealer for inspection of the system.



LDW SERVICE REQUIRED



CAMERA SERVICE REQUIRED

NOTE

- If the sensor or its surrounding area becomes extremely hot (after prolonged exposure to direct sunlight, for example), the “LDW SERVICE REQUIRED” message may appear. If the message remains even after the temperature of the sensor or its surrounding area has been in range, please contact an authorized Mitsubishi Motors dealer.

Tire pressure monitoring system

N00530201625

The tire pressure monitoring system uses tire inflation pressure sensors (A) on the wheels to monitor the tire inflation pressures. The system only indicates when a tire is significantly under-inflated.

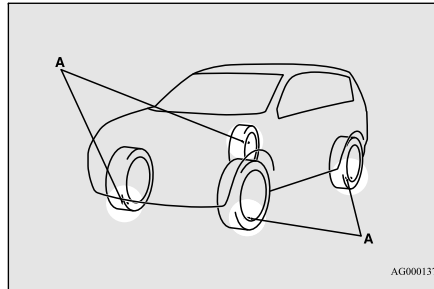

WARNING

- **The compact spare wheel does not have a tire inflation pressure sensor. When the spare tire is used, the tire pressure monitoring system will not work properly. See an authorized Mitsubishi Motors dealer as soon as possible to replace or repair the original tire.**

Tire pressure monitoring system

NOTE

- The tire pressure monitoring system is not a substitute for regularly checking tire inflation pressures. Be sure to check the tire inflation pressures as described in “Tires” on page 9-14.
- The tire inflation pressure sensor (B) is installed in the illustrated location.
 - On vehicles with Type 1 sensor which has the metallic air valve (C), replace grommet and washer (D) with a new one when the tire is replaced.
 - On vehicles with Type 2 sensor which has the rubber air valve (E), replace rubber air valve (E) with a new one when the tire is replaced.

5

5

Tire pressure monitoring system

NOTE

For details, please contact your authorized Mitsubishi Motors dealer.

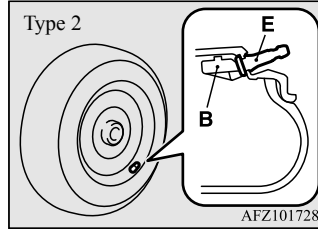
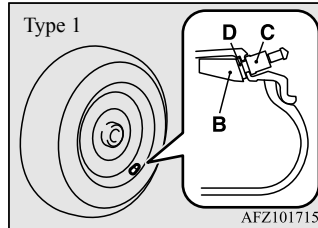

The tire pressure monitoring system warning light / display

N00532700281



When the ignition switch is turned to the “ON” position or the operation mode is put in ON, the tire pressure monitoring system

warning light normally illuminates and goes off a few seconds later.

If one or more of the vehicle tires (except for the spare tire) is significantly under-inflated, the warning light will remain illuminated while the ignition switch or the operation mode is in ON.

Refer to “If the warning light / display illuminates while driving” on page 5-91 and take the necessary measures.

NOTE

- In addition, the warning display is displayed on the information screen in the multi-information display.

Type 1



Type 2



CAUTION

- If the tire pressure monitoring system warning light does not illuminate when the ignition switch is turned to the “ON” position or the operation mode is put in ON, it means that the tire pressure monitoring system is not working properly. Have the system inspected by an authorized Mitsubishi Motors dealer.

In such situations, a malfunctioning of the system may be preventing the monitoring of the tire pressure. Avoid sudden braking, sharp turning and high-speed driving.

- If a malfunction is detected in the tire pressure monitoring system, the tire pressure monitoring system warning light will blink for approximately 1 minute and then remain continuously illuminated. The warning light will issue further warnings each time the engine is restarted as long as the malfunction exists.

Check to see whether the warning light goes off after few minutes driving.

If it then goes off during driving, there is no problem.

However, if the warning light does not go off, or if it blinks again when the engine is restarted, have the vehicle inspected by an authorized Mitsubishi Motors dealer.

In such situations, a malfunctioning of the system may be preventing the monitoring of the tire pressure. For safety reasons, when the warning light appears while driving, avoid sudden braking, sharp turning and high-speed driving.

NOTE

- In addition, the warning display is displayed on the information screen in the multi-information display.

Type 1



Type 2



Each tire, including the spare (if provided), should be checked monthly when cold and inflated to the inflation pressure recommended by the vehicle manufacturer on the vehicle placard or tire inflation pressure label. (If your vehicle has tires of a different size than the size indicated on the vehicle placard or tire inflation pressure label, you should determine the proper tire inflation pressure for those tires.)

As an added safety feature, your vehicle has been equipped with a tire pressure monitoring system (TPMS) that illuminates a low tire

pressure telltale when one or more of your tires is significantly under-inflated.

Accordingly, when the low tire pressure telltale illuminates, you should stop and check your tires as soon as possible, and inflate them to the proper pressure. Driving on a significantly under-inflated tire causes the tire to overheat and can lead to tire failure.

Under-inflation also reduces fuel efficiency and tire tread life, and may affect the vehicle's handling and stopping ability. Please note that the TPMS is not a substitute for proper tire maintenance, and it is the driver's responsibility to maintain correct tire pressure, even if under-inflation has not reached the level to trigger illumination of the TPMS low tire pressure telltale.

Your vehicle has also been equipped with a TPMS malfunction indicator to indicate when the system is not operating properly. The TPMS malfunction indicator is combined with the low tire pressure telltale.

When the system detects a malfunction, the telltale will flash for approximately one minute and then remain continuously illuminated. This sequence will continue upon subsequent vehicle start-ups as long as the malfunction exists.

When the malfunction indicator is illuminated, the system may not be able to detect or signal low tire pressure as intended.

Tire pressure monitoring system

TPMS malfunctions may occur for a variety of reasons, including the installation of replacement or alternate tires or wheels on the vehicle that prevent the TPMS from functioning properly. Always check the TPMS malfunction telltale after replacing one or more tires or wheels on your vehicle to ensure that the replacement or alternate tires and wheels allow the TPMS to continue to function properly.

5**If the warning light/display illuminates while driving**

N00532801524

1. If the tire pressure monitoring system warning light illuminates, avoiding hard braking, sharp steering maneuvers and high speeds. You should stop and adjust the tires to the proper inflation pressure as soon as possible. Adjust the spare tire at the same time. Refer to "Tires" on page 9-14.

NOTE

- In addition, the warning display is displayed on the information screen in the multi-information display.
- When inspecting or adjusting the tire pressure, do not apply excessive force to the valve stem to avoid breakage.

Tire pressure monitoring system

5

NOTE

- After inspecting or adjusting the tire pressure, always reinstall the valve cap on the valve stem. Without the valve cap, dirt or moisture could get into the valve, resulting in damage to the tire inflation pressure sensor.
- Do not use metal valve caps, which may cause a metal reaction, resulting in corrosion and damage of the tire inflation pressure sensors.
- Once adjustments have been made, the warning light will go off after a few minutes of driving.

2. If the tire pressure monitoring system warning light remains illuminated after you have been driving for about 20 minutes after you adjust the tire inflation pressure, one or more of the tires may have a puncture. Inspect the tire and if it has a puncture, have it repaired by an authorized Mitsubishi Motors dealer as soon as possible.

WARNING

- **If the warning light/display illuminates while you are driving, avoid hard braking, sharp steering maneuvers and high speeds. Driving with an under-inflated tire adversely affects vehicle performance and can result in an accident.**

5-92 Features and controls

CAUTION

- If a tire has a puncture, replace that tire with the spare tire. Driving on a punctured tire could lead to an accident.
- The warning light/display may not illuminate immediately in the event of a tire blowout or rapid leak.

NOTE

- To avoid the risk of damage to the tire inflation pressure sensors, have any punctured tire repaired by an authorized Mitsubishi Motors dealer. If the tire repair is not done by an authorized Mitsubishi Motors dealer, it is not covered by your warranty.
- Do not use an aerosol puncture-repair spray on any tire. Such a spray could damage the tire inflation pressure sensors. Have any puncture repaired by an authorized Mitsubishi Motors dealer.

The tire pressure monitoring system may not work normally in the following circumstances:

- A wireless facility or device using the same frequency is near the vehicle.
- Snow or ice is stuck inside the fenders and/or on the wheels.
- The tire inflation pressure sensor's battery is dead.

- Wheels other than Mitsubishi genuine wheels are being used.
- Wheels that are not fitted with tire inflation pressure sensors are being used.
- Wheels whose ID codes are not memorized by the vehicle are used.
- Compact spare tire is fitted on a road wheel.
- A window tint that affects the radio wave signals is installed.

NOTE

- Tire inflation pressures vary with the ambient temperature. If the vehicle is subjected to large variations in ambient temperature, the tire inflation pressures may be under-inflated (causing the warning light/display to come on) when the ambient temperature is relatively low. If the warning light/display comes on, adjust the tire inflation pressure.

Whenever the tires and wheels are replaced with new ones

N00532901192

If new wheels with new tire inflation pressure sensors are installed, their ID codes must be programmed into the tire pressure monitoring system. Have the tire and wheel replacement performed by an authorized Mitsubishi Motors dealer to avoid the risk of damaging the tire inflation pressure sensors. If the

Rear-view camera

wheel replacement is not done by an authorized Mitsubishi Motors dealer, it is not covered by your warranty.

CAUTION

- The use of non-genuine wheels will prevent the proper fit of the tire inflation pressure sensors, resulting air leakage or damage of the sensors.

General information

N00533001246

Your tire pressure monitoring system operates on a radio frequency subject to Federal Communications Commission (FCC) Rules (For vehicles sold in U.S.A.) and Industry Canada Rules (For vehicles sold in Canada). This device complies with part 15 of FCC Rules and Industry Canada licence-exempt RSS standard(s).

Operation is subject to the following two conditions.

- This device may not cause harmful interference.
- This device must accept any interference received, including interference that may cause undesired operation.

CAUTION

- Changes or modifications not expressly approved by the manufacturer for compliance could void the user's authority to operate the equipment.

Rear-view camera

N00546201343

When the gearshift lever or the selector lever is in the "R" position with the ignition switch or the operation mode is in ON, the rear-view image will be displayed on the screen of the Smartphone Link Display Audio or the DISPLAY AUDIO in the center panel.

When the gearshift lever or the selector lever is shifted out of the "R" position, the rear-view image will go off.

WARNING

- **Never rely solely on the rear-view camera to clear the area behind your vehicle. Always check visually behind and all around your vehicle for persons, animals, obstructions or other vehicles. Failure to do so can result in vehicle damage, serious injury or death.**
- **The rear-view camera is an aid system for backing up, but it is not a substitute for your visual confirmation.**

WARNING

- **The view on the screen is limited, and objects outside the view, such as under the bumper or around either corner of the bumper end, cannot be seen on the screen.**

Location of rear-view camera

5

The rear-view camera (A) is in the liftgate, at the left side of the liftgate handle.

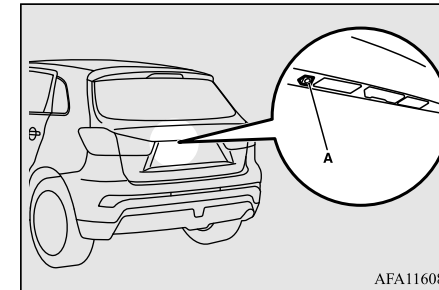

CAUTION

- If the camera lens gets dirty, a clear image cannot be obtained. As necessary, rinse the lens with clean water and gently wipe with a clean, soft cloth.
- To avoid damaging the camera;
 - Do not rub the cover excessively or polish it by using an abrasive compound.
 - Do not disassemble the camera.

Rear-view camera

CAUTION

- Do not splash hot water directly on the lens.
- Do not spray the camera and its surroundings with high-pressure water.
- Make sure that the liftgate is securely closed when backing up.

5 Reference lines on the screen

Reference lines and upper surface of the rear bumper (A) are displayed on the screen.

- Red line (B) indicates approximately 20 inches (50 cm) behind the rear bumper.
- Two Green lines (C) indicate approximately 8 inches (20 cm) outside of the vehicle body.
- Short transverse lines (1 to 3) indicate distance from the rear bumper.

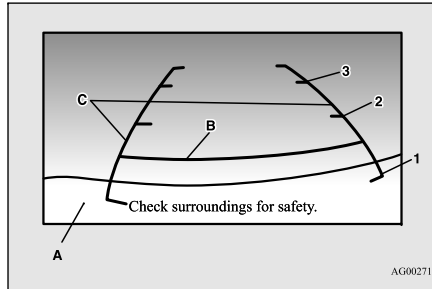

- 1: Approximately at the rear edge of the rear bumper
- 2: Approximately 39 inches (100 cm)
- 3: Approximately 79 inches (200 cm)

CAUTION

- The rear-view camera uses a wide-angle lens. As a result, images and distances shown on the screen are not exact.
- Actual distance may be different from distance indicated by the lines on the screen, depending on the loading condition of the vehicle and road surface condition. The reference lines for distance and vehicle width are based on a level, flat road surface. In the following cases, objects shown on the screen will appear to be farther off than they actually are.
 - When the rear of the vehicle is weighed down with the weight of passengers and luggage in the vehicle. (Case 1)

CAUTION

- When there is an upward slope at the back. (Case 2)

Case 1

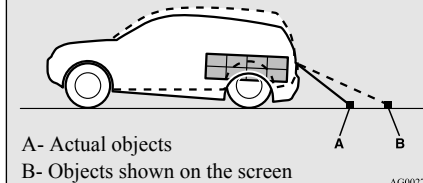

Case 2

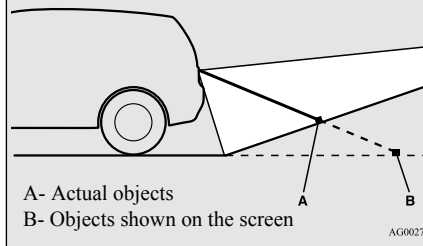

Instrument cluster

CAUTION

- The reference lines for distance and vehicle width are intended to indicate the distance to a flat object such as a level, flat road surface. They may not indicate correct distance depending on the shape of an obstacle. For example, when there is an object behind the vehicle that has upper sections projecting in the direction of the vehicle, the reference lines on the screen will indicate that point A is the farthest point and point B is the closest point to the vehicle. In reality, point A and B are actually the same distance from the vehicle, and point C is farther off than point A and B.

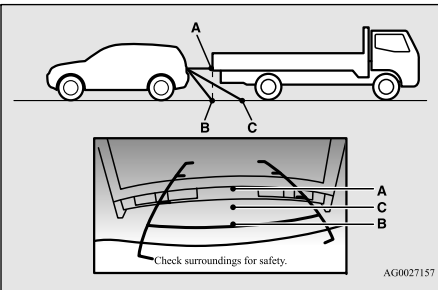

NOTE

- Mirror image is displayed on the screen.
- Monitor brightness is adjusted automatically by sensors.

NOTE

- On vehicles equipped with Smartphone Link Display Audio, it is possible to change the display language of the screen. For details, please refer to the separated owner's manual.
- Under certain circumstances, it may become difficult to see an image on the screen, even when the system is functioning correctly.
 - In a dark area, such as at night.
 - When water drops or condensation are on the lens.
 - When sun light or headlights shine directly into the lens.

Instrument cluster

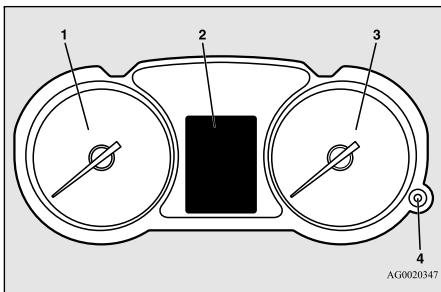

- 1- Tachometer → P.5-96
- 2- Multi-information display → P.5-97
Information screen display list → P.5-120

- 3- Speedometer → P.5-95
- 4- Rheostat meter illumination button → P.5-96

Speedometer

N00519100259

The speedometer shows the vehicle speed in miles per hour (mph) or kilometers per hour (km/h).

5

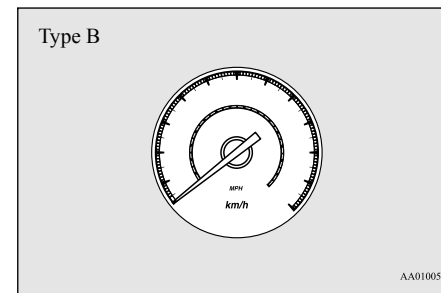
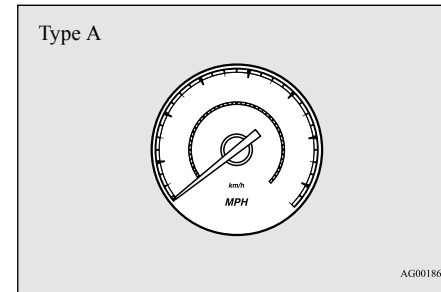

Features and controls 5-95

Instrument cluster

Tachometer

N00519200289

The tachometer shows engine revolutions per minute. This allows the driver to determine the most efficient selector position and engine speed combinations.

5 This gauge also assists in evaluating engine performance.

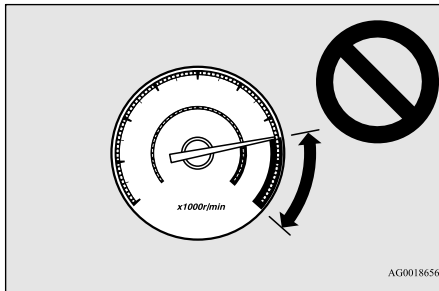

CAUTION

- The red zone indicates an engine speed beyond the range of safe operation. Select the correct shift position (manual transaxle) or selector position (CVT) to control the engine speed so that the tachometer indicator does not enter the red zone.

Rheostat meter illumination button

N00554901251

Each time you press this button, there is a sound and the brightness of the instruments changes.

NOTE

- You can adjust to 8 different levels respectively for when the front side-marker and parking lights are illuminated and when they are not.
- If the vehicle is equipped with the automatic light control, when the light switch is in a position other than the "OFF" position, the meter illumination switches automatically to the adjusted brightness, depending on the brightness outside the vehicle.
- The brightness level of the instruments is stored when the ignition switch is turned to the "OFF" position or the operation mode is put in OFF.
- If you press and hold the button for longer than about 1 second when the front side-marker lights are illuminated, the brightness level changes to the maximum level. Pressing and holding the button for longer than about 1 second again returns the brightness level to the previous level.

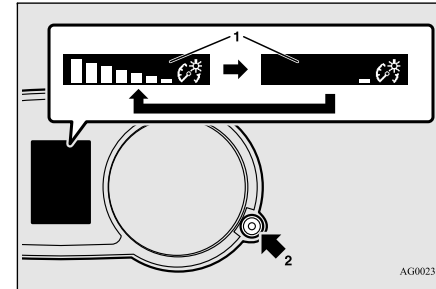

- 1- Brightness display
- 2- Rheostat illumination button

Multi-information display

Multi-information display

N00555001406

The multi-information display displays warnings, the odometer, trip odometer, service reminder, engine coolant temperature, fuel remaining, outside temperature, selector lever position, all-wheel drive operation status, average and momentary fuel consumption, driving range, average speed, instrument brightness, etc.

It is also possible to change elements such as the language and units used on the multi-information display.

5

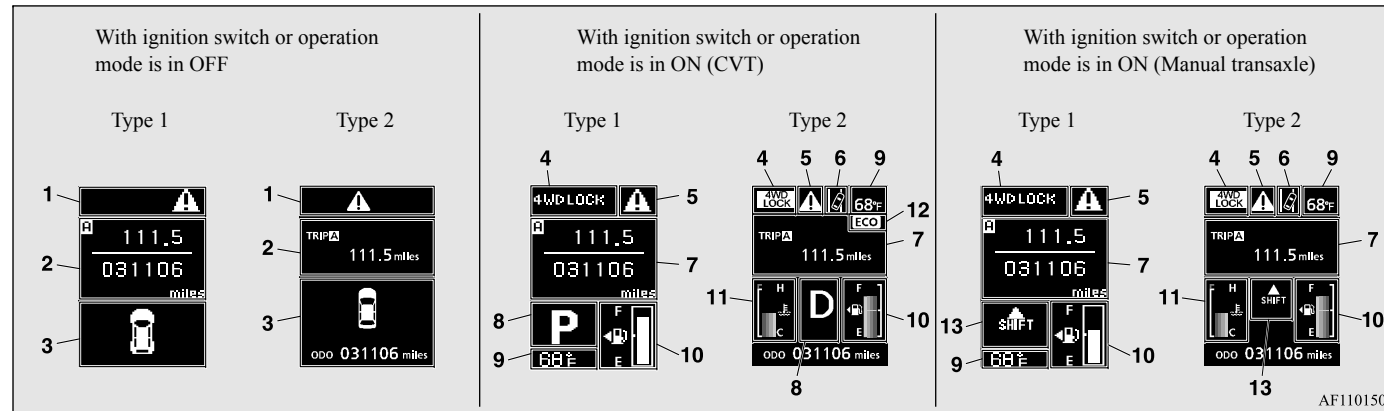

- 1- Warning display screen (With ignition switch or operation mode in OFF) → P.5-98
- 2- Information screen (With ignition switch or operation mode in OFF) → P.5-99
Interrupt display screen (With ignition switch or operation mode in OFF) → P.5-100

- 3- Door ajar warning display screen (With ignition switch or operation mode in OFF) → P.5-101
- 4- Drive mode indicator display screen (if so equipped) → P.5-102
- 5- Warning display screen (With ignition switch or operation mode in ON) → P.5-102

- 6- Lane Departure Warning (LDW) display screen (if so equipped) → P.5-86
- 7- Information screen (With ignition switch or operation mode in ON) → P.5-103
Interrupt display screen (With ignition switch or operation mode in ON) → P.5-106

Features and controls 5-97

Multi-information display

- 8- Selector lever position display screen (if so equipped) → P.5-107
- 9- Outside temperature display screen → P.5-107
- 10- Fuel remaining display screen → P.5-108
- 11- Engine coolant temperature display (if so equipped) → P.5-103
- 12- ECO mode indicator (if so equipped) → P.5-107
- 13- Gearshift indicator display screen (if so equipped) → P.5-49

5

NOTE

- The fuel units, temperature units, display language, and other settings can be changed. Refer to “Changing the function settings (With ignition switch or operation mode in ON)” on page 5-110.

NOTE

- The display screen is different depending on whether the ignition switch or the operation mode in OFF or ON.
Refer to “Information screen (With ignition switch or operation mode in OFF)” on page 5-99.
Refer to “Warning display list (With ignition switch or operation mode in OFF)” on page 5-120.
Refer to “Information screen (With ignition switch turned from the “OFF” position to the “ON” position or operation mode changed from OFF to ON)” on page 5-101.
Refer to “Information screen (With ignition switch or operation mode in ON)” on page 5-103.
Refer to “Warning display list (With ignition switch or operation mode in ON)” on page 5-123.

Multi-information meter switch

N00555100149

The multi-information meter switch is a button marked “INFO” on the left side of the dash.

Each time the multi-information meter switch is operated, a sound is emitted and the multi-information display changes between information such as warnings, Odometer (Type1), trip odometer, service reminder, engine coolant temperature (Type 1), average and

momentary fuel consumption, driving range, and average speed.

It is also possible to change elements such as the language and units used on the multi-information display by operating the multi-information meter switch.

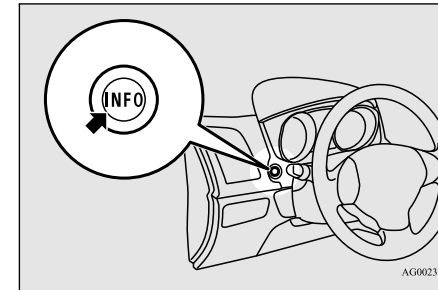

Warning display screen (With ignition switch or operation mode in OFF)

N00555200179

If you press the multi-information meter switch and return from the warning display screen to the previous screen, the **A** warning is displayed.

Refer to “Returning to the display screen from before the warning display” on page 5-100.

Multi-information display

This mark is also displayed if there is another warning other than the one displayed. When the cause of the warning display is eliminated, the **A** warning goes out automatically.

NOTE

- When the **A** warning is displayed, the warning display screen can be redisplayed on the information screen.
Refer to “Information screen (With ignition switch or operation mode in OFF)” on page 5-99.
- Refer to “Information screen (With ignition switch or operation mode in ON)” on page 5-103.

Information screen (With ignition switch or operation mode in OFF)

N00555301180

Each time you lightly press the multi-information meter switch, the display screen switches in the following order.

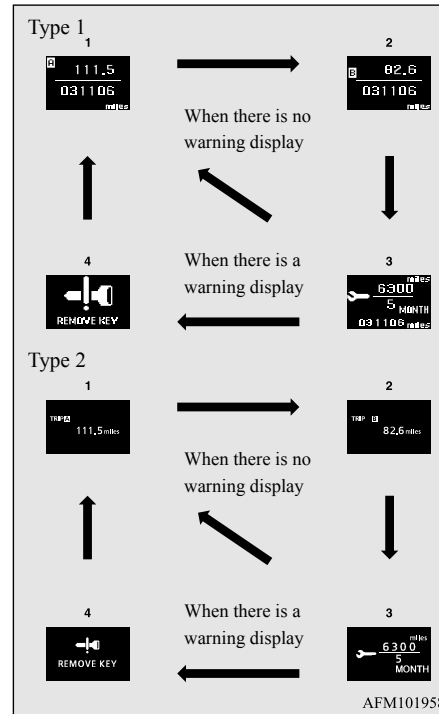

- Odometer (Type1)/Trip odometer **A**
- Odometer (Type1)/Trip odometer **B**
- Service reminder
- Redisplay of a warning display screen

Odometer/Trip odometer

N00555400113

Each time you lightly press the multi-information meter switch, the display screen switches.

Odometer/trip odometer **A** → Odometer/trip odometer **B** → Service reminder → Redisplay of a warning display screen → Odometer/trip odometer **A**.

Odometer

Shows the total distance traveled.

Trip odometer

Shows the distance traveled between two points.

Usage examples for trip odometer **A**, trip odometer **B**

It is possible to measure two currently traveled distances, from home using trip odometer **A** and from a particular point on the way using trip odometer **B**.

To reset the trip odometer

To return the display to 0, hold down the multi-information meter switch for about 2

Multi-information display

seconds or more. Only the currently displayed value will be reset.

Example

If trip odometer **A** is displayed, only trip odometer **A** will be reset.

5

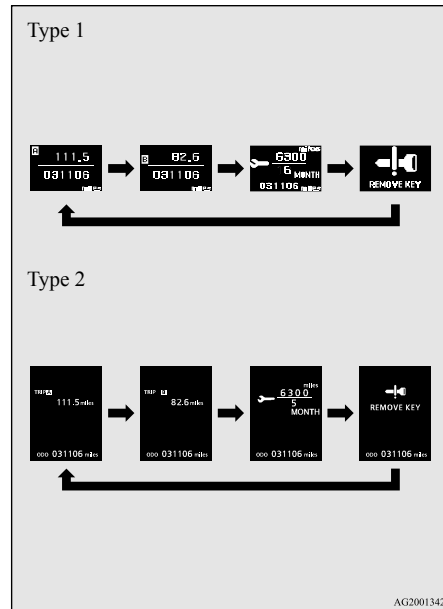

NOTE

- If there is no warning display, the switching sequence is: odometer/trip odometer **A** → odometer/trip odometer **B** → service reminder → odometer/trip odometer **A**.
- Both trip odometers **A** and **B** can count up to 9999.9 miles/kilometers. When a trip odometer goes past 9999.9 miles/kilometers, it returns to 0.0 miles/kilometers.
- When disconnecting the battery terminal, the memories of trip odometer displays **A** and **B** are cleared, and their displays return to “0.0 miles/kilometers”.

Service reminder

N0055500042

Shows the distance and number of months until the next periodic inspection. Refer to “Service reminder” on page 5-108.

Interrupt display screen (With ignition switch or operation mode in OFF)

N00559600201

When there is information to be announced, such as a key reminder, the buzzer sounds and switches to the warning display screen. Refer

to the appropriate page and take the necessary measures.

When the cause of the warning display is eliminated, the warning display goes out automatically.

Refer to “Warning display list (With ignition switch or operation mode in OFF)” on page 5-120.

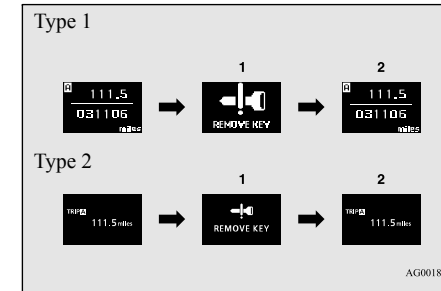

- 1- Information generated
- 2- Cause eliminated

Returning to the display screen from before the warning display

Even if the cause of the warning display is not eliminated, you can return to the screen that was displayed before the warning display.

If you press the multi-information meter switch, the display screen switches to the

Multi-information display

screen display from before the warning and the  warning (A) is displayed.

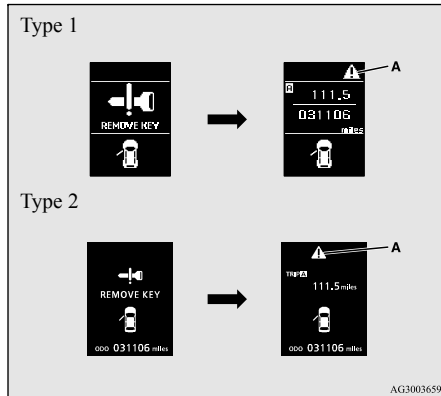

switch a few times, the warning display screen you switched from is redisplayed. Refer to “Information screen (With ignition switch or operation mode in OFF)” on page 5-99.

Door ajar warning display screen (With ignition switch or operation mode in OFF)

N00559700156

If any of the doors or the liftgate is not completely closed, this displays the open door or liftgate.

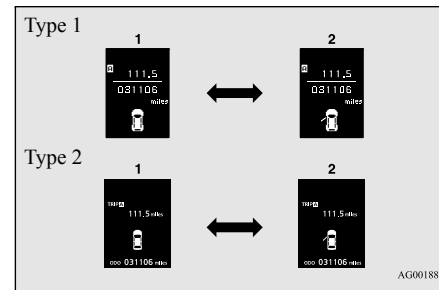

- 1- Doors and liftgate are closed
- 2- Doors or liftgate is open

Information screen (With the ignition switch is turned from the “OFF” position to the “ON” position or the operation mode is changed from OFF to ON)

N00555801257

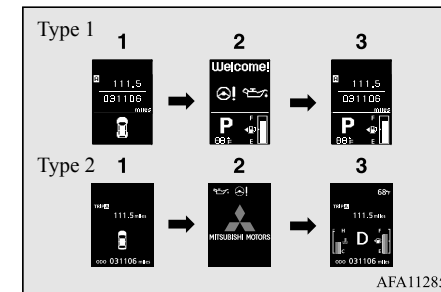

5

When the ignition switch is turned to the “ON” position or the operation mode changed to ON, the display screen switches in the following order.



- 1- Screen when the ignition switch or operation mode is OFF)
- 2- System check screen
- 3- Screen when the ignition switch or operation mode is ON)

NOTE

- Warning display screens with a  or “” mark displayed in the upper right of the screen can be switched. If you want to switch the display, press the multi-information meter switch as follows.

: Press lightly.

: Press for about 2 seconds or more.

Redisplay of a warning display screen

When the  warning is displayed, if you lightly press the multi-information meter

Multi-information display

System check screen

When the ignition switch is turned to the “ON” position or the operation mode is changed to ON, the system check screen is displayed for about 4 seconds. If there is no fault, the information screen is displayed.

5

If there is a fault, the screen changes to warning display. Refer to “Warning display list (With ignition switch or operation mode in ON)” on page 5-123.

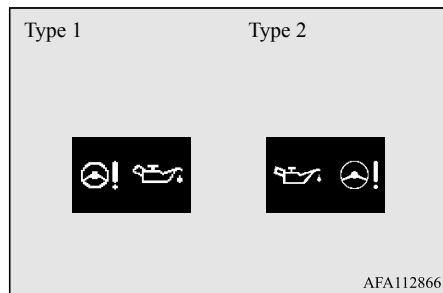

NOTE

- The system check screen display varies depending on your equipment.

Service reminder

When the time for periodic inspection arrives, the warning display is displayed for a few seconds after the screen that is initially displayed when the ignition switch is turned “ON” or the operation mode is changed to ON.

Refer to “Service reminder” on page 5-108.

Type 1



Type 2



Drive mode indicator display screen (if so equipped)

N0055900020

Shows the 4WD drive status.

Refer to “Drive mode-selector” on page 5-58.

Warning display screen (With ignition switch or operation mode in ON)

N00555200182

This is displayed when you press the multi-information meter switch and switch the warning display screen.

This mark is also displayed if there is another warning other than the one displayed.

When the cause of the warning display is eliminated, the warning goes out automatically.

NOTE

- When the warning is displayed, the warning display screen can be redisplayed on the information screen. Refer to “Information screen (With ignition switch or operation mode in OFF)” on page 5-99. Refer to “Information screen (With ignition switch or operation mode in ON)” on page 5-103.

Multi-information display

Information screen (With ignition switch or operation mode in ON)

N00556201245

Each time you lightly press the multi-information meter switch, the display screen switches in the following order.

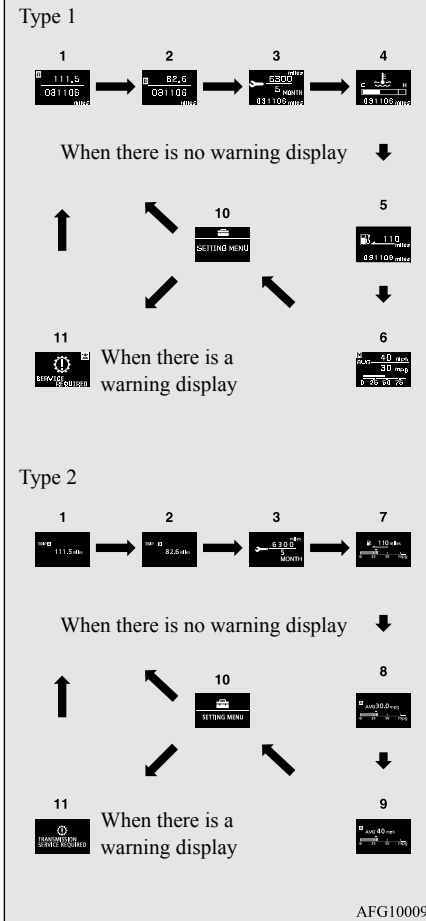

- 1- Odometer (Type1)/Trip odometer **A**
- 2- Odometer (Type1)/Trip odometer **B**
- 3- Service reminder
- 4- Engine coolant temperature display (Type 1)
- 5- Driving range display (Type 1)
- 6- Average speed display, average fuel consumption display, momentary fuel consumption display (Type 1)
- 7- Driving range display, momentary fuel consumption display (Type 2)
- 8- Average fuel consumption display, momentary fuel consumption display (Type 2)
- 9- Average speed display, momentary fuel consumption display (Type 2)
- 10- Function setting screen
- 11- Redisplay of a warning display screen

NOTE

- While driving, the function setting screen is not displayed even if you operate the multi-information meter switch. Always park the vehicle in a safe place before operating. Refer to “Changing the function settings (With ignition switch or operation mode in ON)” on page 5-110.

Multi-information display

NOTE

- When there is information to be announced, such as a system fault, the tone sounds and the screen display is switched. Refer to “Interrupt display screen (With ignition switch or operation mode in ON)” on page 5-106.

5

Odometer/Trip odometer

The operation method is the same as when the ignition switch or the operation mode is in OFF.

For further details, refer to “Odometer/Trip odometer” on page 5-99.

Service reminder

Shows the distance and number of months until the next periodic inspection. Refer to “Service reminder” on page 5-108.

Engine coolant temperature display

Shows the engine coolant temperature.

If the coolant becomes hot, “” will blink. Pay careful attention to the engine coolant temperature display while you are driving.

5-104 Features and controls

CAUTION

- If the engine is overheating, “” will blink. In this case, the bar graph is on the red zone. Immediately park the vehicle in a safe place and take the required measures. Refer to “Engine overheating” on page 8-4.

Driving range display

Shows the approximate driving range (how many more miles or kilometers you can drive). When this driving range falls below 30 miles (50 km), “---” is displayed. Refuel as soon as possible.

NOTE

- The driving range is determined based on the fuel consumption data. This may vary depending on the driving conditions and habits. Treat the distance displayed as just a rough guideline.
- When you refuel, the driving range display is updated. However, if you only add a small amount of fuel, the correct value will not be displayed. Fill to a full tank whenever possible.
- When your vehicle is stopped on an extremely steep hill, the driving range value may change. This is due to the movement of fuel in the tank and does not indicate any breakdown.

NOTE

- The display setting can be changed to the preferred units (miles or km). Refer to “Changing the function settings (With ignition switch or operation mode in ON)” on page 5-110.

Average speed display

This displays the average speed from the last reset to the present.

There are 2 types of mode settings as follows. For details on how to change the average speed display setting, refer to “Changing the function settings (With ignition switch or operation mode in ON)” on page 5-110.

Manual reset mode

- When the average speed is being displayed, if you hold down the multi-information meter switch, these calculations will be reset to zero.
- When the following operation is performed, the mode setting changes automatically from manual to auto.

[Except for vehicles equipped with the F.A.S.T.-key]

Turn the ignition switch to the “ON” position from the “ACC” or “OFF” position.

Multi-information display

[For vehicles equipped with the F.A.S.T.-key]

Change the operation mode to ON from ACC or OFF.

Auto reset mode

- When the average speed is being displayed, if you hold down the multi-information meter switch, these calculations will be reset to zero.
- When the engine switch or the operation mode is in the following conditions, the average speed display will automatically reset.

[Except for vehicles equipped with the F.A.S.T.-key]

The ignition switch has been set to the “ACC” or “OFF” position for about 4 hours or more.

[For vehicles equipped with the F.A.S.T.-key]

The operation mode has been set to ACC or OFF for about 4 hours or more.

NOTE

- The average speed display and the average fuel consumption display can be reset separately in both auto reset mode and manual reset mode.

NOTE

- “---” is displayed when the average speed cannot be measured.
- The initial (default) setting is “Auto reset mode”.
- The display setting can be changed to the preferred units (mph or km/h). Refer to “Changing the function settings (With ignition switch or operation mode in ON)” on page 5-110.
- Disconnecting the battery cable will erase from memory the manual reset mode or auto reset mode setting for the average speed display.

Average fuel consumption display

This displays the average fuel consumption from the last reset to the present.

There are 2 types of mode settings as follows. For details on how to change the average fuel consumption display setting, refer to “Changing the function settings (With ignition switch or operation mode in ON)” on page 5-110.

The “” mark in the momentary fuel gauge shows the average fuel consumption. (Type 2)

Manual reset mode

- When the average fuel consumption is being displayed, if you hold down the multi-information meter switch, these calculations will be reset to zero.
- When the following operation is performed, the mode setting changes automatically from manual to auto.

[Except for vehicles equipped with the F.A.S.T.-key]

Turn the ignition switch to the “ON” position from the “ACC” or “OFF” position.

[For vehicles equipped with the F.A.S.T.-key]

Change the operation mode to ON from ACC or OFF.

Auto reset mode

- When the average fuel consumption is being displayed, if you hold down the multi-information meter switch, these calculations will be reset to zero.
- When the engine switch or the operation mode is in the following conditions, the average fuel consumption display will automatically reset.

[Except for vehicles equipped with the F.A.S.T.-key]

Multi-information display

The ignition switch has been set to the “ACC” or “OFF” position for about 4 hours or more.

[For vehicles equipped with the F.A.S.T.-key]

The operation mode has been set to ACC or OFF for about 4 hours or more.

5

NOTE

- The average speed display and the average fuel consumption display can be reset separately in both auto reset mode and manual reset mode.
- “--” is displayed when the average fuel consumption cannot be measured.
- The initial (default) setting is “Auto reset mode”.
- Average fuel consumption may vary depend on the driving conditions (road conditions, how you drive, etc.) The actual fuel consumption may differ from the fuel consumption displayed, so treat the fuel consumption displayed as just a rough guideline.
- Disconnecting the battery cable will erase from memory the manual reset mode or auto reset mode setting for the average fuel consumption display.
- The display setting can be changed to the preferred units {mpg(US), mpg(UK), L/100km or km/L}.
Refer to “Changing the function settings (With ignition switch or operation mode in ON)” on page 5-110.

5-106 Features and controls

Momentary fuel consumption display

While driving, the momentary fuel consumption is shown with a bar graph.

When the momentary fuel consumption surpasses the average fuel consumption, the momentary fuel consumption is displayed with a green bar graph. (Type 2)

Be conscious of maintaining the momentary fuel consumption above the average fuel consumption, it can help you drive with the better fuel consumption.

NOTE

- When the momentary fuel consumption cannot be measured, a bar graph is not shown.
- The display setting can be changed to the preferred units {mpg(US), mpg(UK), L/100km or km/L}.
Refer to “Changing the function settings (With ignition switch or operation mode in ON)” on page 5-110.
- It is possible to cancel the green bar graph.
Refer to “Changing the function settings (With ignition switch or operation mode in ON)” on page 5-110.

Function setting screen

The “Display language”, “Temperature unit”, “Fuel consumption unit”, and “Average fuel consumption and speed reset method” settings can be modified as desired.

For further details, refer to “Changing the function settings (With ignition switch or operation mode in ON)” on page 5-110.

Interrupt display screen (With ignition switch or operation mode in ON)

N00556300180

Warning display

When there is information to be announced, such as a system fault, a tone sounds and the information screen is switched to the warning display screen.

Refer to the warning list and take the necessary measures. Refer to “Warning display list (With ignition switch or operation mode in ON)” on page 5-123.

When the cause of the warning display is eliminated, the warning display goes out automatically.

Multi-information display

Returning to the display screen from before the warning display

Even if the cause of the warning display is not eliminated, you can return to the screen that was displayed before the warning display.

If you press the multi-information meter switch, the display screen switches to the screen display from before the warning and the **A** warning (A) is displayed.

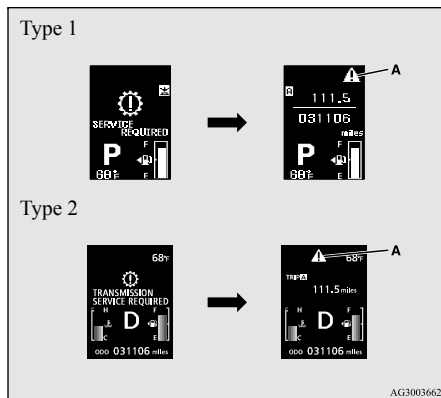

NOTE

- Warning display screens with a **A** or **A** mark displayed in the upper right of the screen can be switched. If you want to switch the display, press the multi-information meter switch as follows.
 - A**: Press lightly.
 - A**: Press for about 2 seconds or more.

Redisplay of a warning display screen

When the **A** warning is displayed, if you lightly press the multi-information meter switch a few times, the warning display screen you switched from is redisplayed.

Other interrupt displays

The operation status of each system is displayed on the information screen. For further details, refer to the appropriate page in the warning display list. Refer to “Other interrupt displays” on page 5-132.

Selector lever position display screen (if so equipped)

N00556400064

Shows the position of the selector lever. Refer to “Selector lever operation” on page 5-51.

5

Outside temperature display screen

N00556500065

Shows the temperature outside the vehicle.

NOTE

- The display setting can be changed to the preferred units (°F or °C). Refer to “Changing the function settings (With ignition switch or operation mode in ON)” on page 5-110.
- Depending on factors such as the driving conditions, the displayed temperature may vary from the actual outside temperature.

ECO mode indicator (if so equipped)

N00568700019

This indicator will be displayed when fuel-efficient driving is achieved.

Multi-information display

Fuel remaining display screen

N00556600170

Shows the amount of fuel remaining.

5

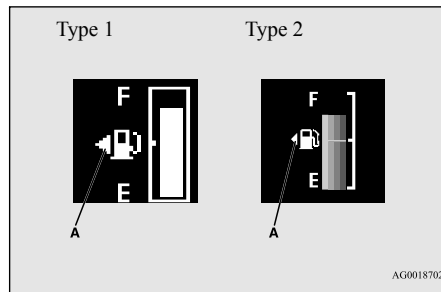

CAUTION

- Running out of gas could damage the catalytic converter. If the warning display appears, refuel as soon as possible.

NOTE

- It may take several seconds to stabilize the display after refilling the tank.
- If fuel is added with the ignition switch or operation mode in ON, the remaining fuel display may incorrectly indicate the fuel level.

Fuel tank filler door mark

The arrow (A) indicates that the fuel tank filler door is located on the left side of the vehicle. (Refer to “Filling the fuel tank” on page 3-3.)

Fuel remaining warning display

When the fuel level runs low, the information screen switches to the interrupt display of the fuel remaining warning display and the mark (B) on the fuel remaining display flashes. If the warning display appears, refuel as soon as possible.

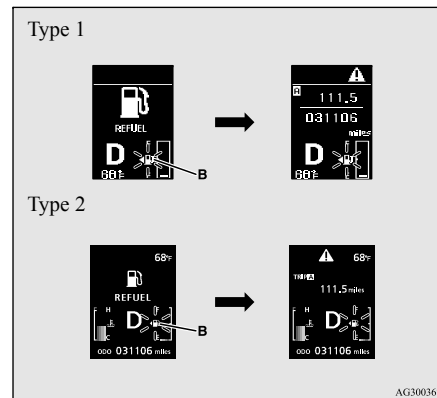

NOTE

- On hills or curves, the display may be incorrect due to the movement of fuel in the tank.

Service reminder

N00556700214

Displays the approximate time until the next recommended periodic inspection. “---” is displayed when the inspection time has arrived.

NOTE

- The service reminder time can be modified by an authorized Mitsubishi Motors dealer, to adjust for severe usage, etc. Refer to “Severe maintenance schedule” in your vehicle’s Warranty and Maintenance Manual. For further information, please contact your authorized Mitsubishi Motors dealer.

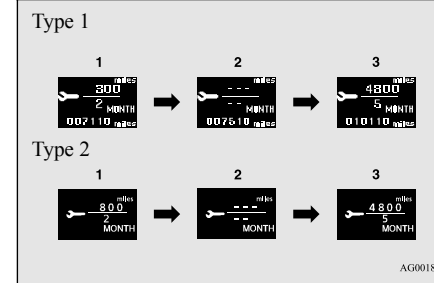

Multi-information display

1. Shows the time until the next periodic inspection.

NOTE

- Shows the distance in units of 100 miles (100 km) and the time in units of 1 month.

2. This informs you that a periodic inspection is due. Contact an authorized Mitsubishi Motors dealer or a repair facility of your choice to have the system checked.

At that time, when the ignition switch is switched from the “OFF” position to the “ON” position or the operation mode is changed from OFF to ON, the warning display is displayed for a few seconds on the information screen.

Type 1



Type 2



3. After your vehicle is inspected at an authorized Mitsubishi Motors dealer, it displays the time until the next periodic inspection.

To reset

The “---” display can be reset while the ignition switch or the operation mode is in OFF. When the display is reset, the time until the next periodic inspection is displayed and the warning display is no longer displayed when the ignition switch is switched from the “OFF” position to the “ON” position or the operation mode is changed from OFF to ON.

1. When you lightly press the multi-information meter switch, the information screen switches to the service reminder display screen.

Type 1



Type 2

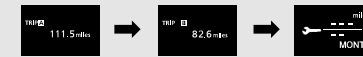

AG3003776

5

2. Press and hold the multi-information meter switch (for about 2 seconds or more) to display “” and make it flash. (If there is no operation for about 10 seconds with this indicator flashing, the display returns to the previous screen.)

3. With this indicator flashing, if you lightly press the multi-information meter switch, the screen switches from “---” to “CLEAR”. After that, the time until the next periodic inspection is shown.

Multi-information display

5

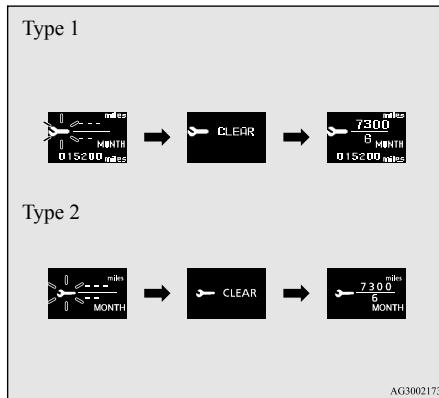

CAUTION

- The customer is responsible for making sure that regular inspections and maintenance and periodic inspections and maintenance are performed. Inspections and maintenance must be performed to prevent accidents and malfunctions.

NOTE

- The “---” display cannot be reset while the ignition switch or the operation mode is in ON.
- When “---” is displayed, after a certain distance and a certain period of time, the display is reset and the time until the next periodic inspection is displayed.

NOTE

- If you accidentally reset the display, consult an authorized Mitsubishi Motors dealer for assistance.

Door ajar warning display screen (With ignition switch or operation mode is in ON)

N00555700132

Type 1



Type 2



If any of the doors or the liftgate is not completely closed, this displays the open door or liftgate.

If the speed increases to about 5 mph (8 km/h) or higher with a door ajar, a tone will sound 4 times to inform you that a door is ajar.

CAUTION

- Always make sure that the warning display goes out before beginning to drive.

Changing the function settings (With ignition switch or operation mode is in ON)

N00556801212

1. Park your vehicle in a safe place. Fully apply the parking brake and move the gearshift lever into the “N” (Neutral) position (Manual transaxle) or the selector lever into the “P” (PARK) position (CVT).
2. When you lightly press the multi-information meter switch, the information screen switches to the function setting screen. Refer to “Information screen (With ignition switch or operation mode in ON)” on page 5-103.

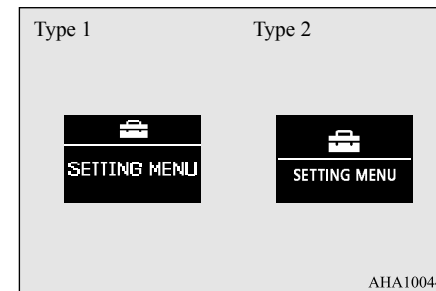

Multi-information display

CAUTION

- For safety, stop the vehicle before operating. While driving, even if you operate the multi-information meter switch, the function setting screen is not displayed.

- Press and hold the multi-information meter switch (for about 2 seconds or more) to switch from the setting mode screen to the menu screen.

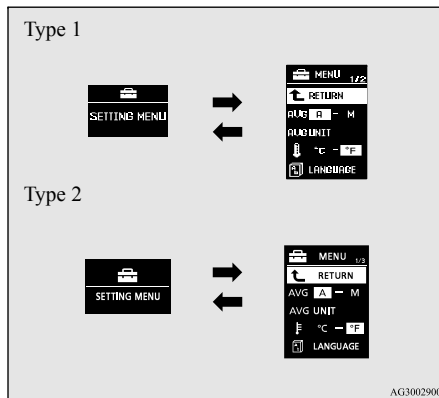

NOTE

- To return the menu screen to the function setting screen, press and hold the multi-information meter switch (for about 2 seconds or more).

NOTE

- If no operations are made within about 15 seconds of the menu screen being displayed, the display returns to the function setting screen.

- Select the item to change on the menu screen and change to the desired setting. For further details on the operation methods, refer to the following sections.

Refer to “Changing the reset mode for average fuel consumption and average speed” on page 5-111.

Refer to “Changing the fuel consumption display unit” on page 5-112.

Refer to “Changing the temperature unit” on page 5-113.

Refer to “Changing the display language” on page 5-114.

Refer to “Operation sound setting” on page 5-114.

Refer to “Changing the time until “REST REMINDER” is displayed” on page 5-115.

Refer to “Changing the turn signal sound” on page 5-115.

Refer to “Changing the momentary fuel consumption display (Type 2)” on page 5-116.

Refer to “Returning to the factory settings” on page 5-116.

Changing the reset mode for average fuel consumption and average speed

N00557000227

You can change the mode condition for the average fuel consumption and average speed display to “Auto reset” or “Manual reset.”

5

- Press and hold the multi-information meter switch (for about 2 seconds or more) to switch from the setting mode screen to the menu screen.

Refer to “Changing the function settings (With ignition switch or operation mode is in ON)” on page 5-110.

- Lightly press the multi-information meter switch to select “AVG” (average fuel consumption and average speed setting).

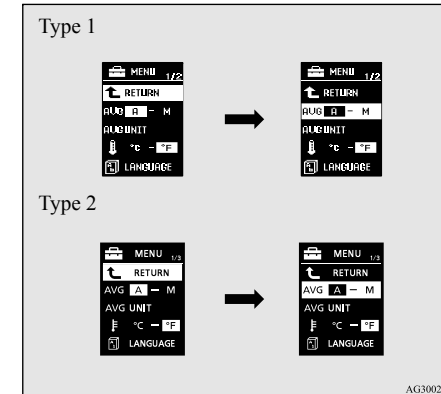

Multi-information display

3. Press and hold the multi-information meter switch (for about 2 seconds or more) to switch in sequence from A or 1 (Auto reset) → M, 2 or P (Manual reset) → A or 1 (Auto reset).
The setting is changed to the selected reset condition.

5

Manual reset mode

- If you press and hold the multi-information meter switch when the average fuel consumption and average speed are displayed, these calculations will be reset to zero.
- When the following operation is performed, the mode setting changes automatically from manual to auto.

[Except for vehicles equipped with the F.A.S.T.-key]
Turn the ignition switch to the “ON” position from the “ACC” or “OFF” position.

[For vehicles equipped with the F.A.S.T.-key]
Change the operation mode to ON from ACC or OFF.

Auto reset mode

- When the average fuel consumption and average speed are being displayed, if you hold down the multi-information meter switch, these calculations will be reset to zero.
- When the engine switch or the operation mode is in the following conditions, the average fuel consumption display and the average speed display will automatically reset.

[Except for vehicles equipped with the F.A.S.T.-key]
The ignition switch has been set to the “ACC” or “OFF” position for about 4 hours or more.

[For vehicles equipped with the F.A.S.T.-key]
The operation mode has been in ACC or OFF for about 4 hours or more.

NOTE

- Disconnecting the battery cable will erase from memory the manual reset mode or auto reset mode setting for the average speed display and average fuel consumption display.
- The initial (default) setting is “Auto reset mode”.

Changing the fuel consumption display unit

N00557100143

The fuel consumption display unit can be changed. The distance, speed, and amount units are also changed to match the selected fuel consumption unit.

1. Press and hold the multi-information meter switch (for about 2 seconds or more) to change from the setting mode screen to the menu screen. Refer to “Changing the function settings (With ignition switch or operation mode is in ON)” on page 5-110.
2. Lightly press the multi-information meter switch to select “AVG UNIT” (fuel consumption display unit setting).

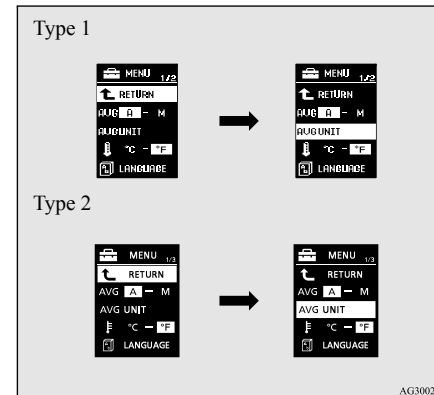

3. Press and hold the multi-information meter switch (for about 2 seconds or more) to display “AVG UNIT” (fuel consumption display unit setting).
4. Lightly press the multi-information meter switch to switch in sequence from km/L → L/100 km → mpg (US) → mpg (UK) → RETURN → km/L.

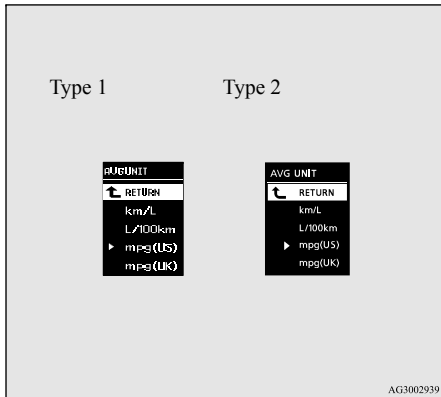

5. Press and hold the multi-information meter switch (for about 2 seconds or more) to change the setting to the selected unit.

NOTE

- The display units for the driving range, the average fuel consumption, the average speed and the momentary fuel consumption are changed, but the units for the indicating needle (speedometer), the odometer and the trip odometer will remain unchanged.
- If the battery is disconnected, the memory of the unit setting is erased and is automatically set to {mpg (US) or L/100 km}.

The distance and speed units are also changed in the following combinations to match the selected fuel consumption unit.

Fuel economy	Distance (driving range)	Speed (average speed)
mpg (US)	mile (s)	mph
mpg (UK)	mile (s)	mph
km / L	km	km / h
L / 100 km	km	km / h

Changing the temperature unit

N00557200115

The temperature display unit can be switched.

Multi-information display

1. Press and hold the multi-information meter switch (for about 2 seconds or more) to switch from the setting mode screen to the menu screen.
Refer to “Changing the function settings (With ignition switch or operation mode is in ON)” on page 5-110.
2. Lightly press the multi-information meter switch to select “” (temperature unit setting).

5

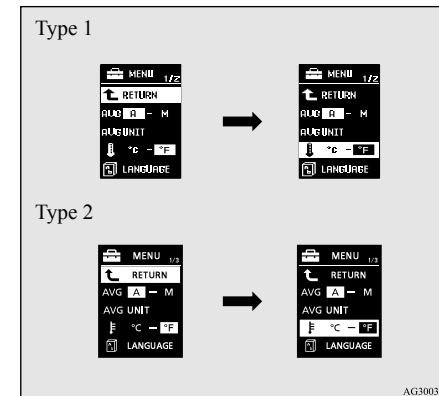

3. Press and hold the multi-information meter switch (for about 2 seconds or more) to change in sequence from °F → °C → °F.
The setting is changed to the selected temperature unit.

Multi-information display

NOTE

- If the battery is disconnected, the memory of the unit setting is erased and is automatically set to °F (°C).

5

Changing the display language

N00557300161

The language of the multi-information display can be changed.

1. Press and hold the multi-information meter switch (for about 2 seconds or more) to change from the setting mode screen to the menu screen.
Refer to “Changing the function settings (With ignition switch or operation mode is in ON)” on page 5-110.
2. Lightly press the multi-information meter switch to select “LANGUAGE” (language setting).

Type 1

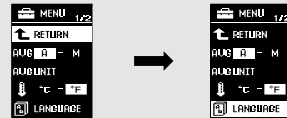

Type 2

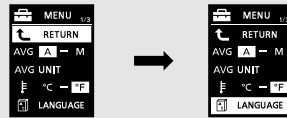

AG3003024

3. Press and hold the multi-information meter switch (for about 2 seconds or more) to display “LANGUAGE” (language setting).
4. Lightly press the multi-information meter switch to select the desired language.
5. Press and hold the multi-information meter switch (for about 2 seconds or more) to change the setting to the selected language.

NOTE

- If the battery is disconnected, the memory of the language setting is erased and is automatically set to ENGLISH.
- If “--” is selected in the language setting, a warning message is not displayed when there is a warning display or interrupt display.

Operation sound setting

N00557400117

You can turn off the operation sounds of the multi-information meter switch and rheostat meter illumination button.

1. Press and hold the multi-information meter switch (for about 2 seconds or more) to switch from the setting mode screen to the menu screen.
Refer to “Changing the function settings (With ignition switch or operation mode is in ON)” on page 5-110.
2. Lightly press the multi-information meter switch to select “” (operation sound setting).

Type 1

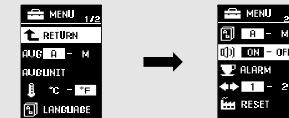

Type 2

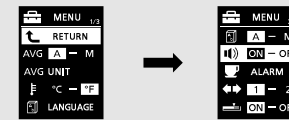

AG3003705

- Press and hold the multi-information meter switch (for about 2 seconds or more) to switch in sequence from ON (operation sound on) → OFF (operation sound off) → ON (operation sound on). The setting is changed to the selected condition.

NOTE

- If the battery is disconnected, the memory of the operation sound setting is erased and is automatically set to “ON” (operation sound on).
- The operation sound setting only deactivates the operation sound of the multi-information meter switch and rheostat meter illumination button. The warning display and other sounds cannot be deactivated.

Changing the time until “REST REMINDER” is displayed

N00557500134

The time until the display appears can be changed.

- Press and hold the multi-information meter switch (for about 2 seconds or more) to switch from the setting mode screen to the menu screen. Refer to “Changing the function settings (With ignition switch or operation mode is in ON)” on page 5-110.

- Lightly press the multi-information meter switch to select “ALARM” (rest time setting).

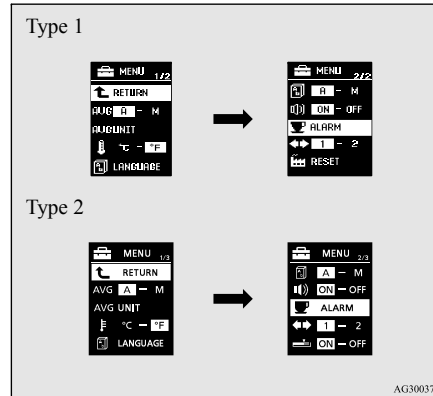

- Press and hold the multi-information meter switch (for about 2 seconds or more) to display “ALARM” (rest time setting).

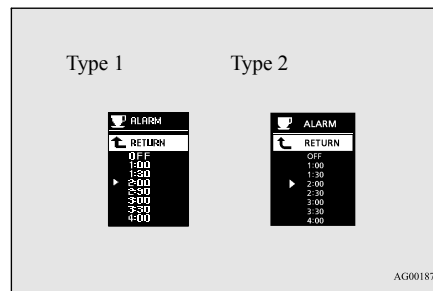

Multi-information display

- Lightly press the multi-information meter switch to select the time until the display appears.
- Press and hold the multi-information meter switch (for about 2 seconds or more) to change the setting to the selected time.

NOTE

- If the battery is disconnected, the memory of the unit setting is erased and is automatically set to the “OFF”.
- The drive time is reset when the ignition switch is in the “OFF” position or the operation mode is in OFF.

5

Changing the turn signal sound

N00563500041

It is possible to change the turn signal sound.

- Press and hold the multi-information meter switch for about 2 seconds or more to switch from the setting mode screen to the menu screen. Refer to “Changing the function settings (With ignition switch or operation mode is in ON)” on page 5-110.
- Lightly press the multi-information meter switch to select (changing the turn signal sound)

Multi-information display

5

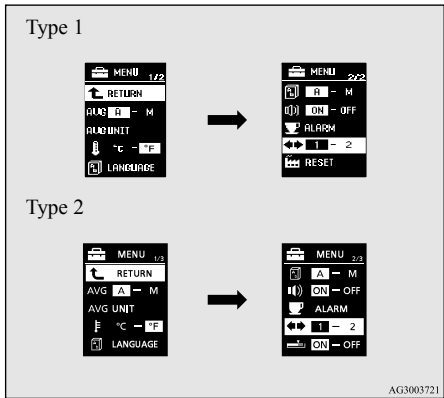

3. Press and hold the multi-information meter switch for about 2 seconds or more to switch in sequence from 1 (turn signal sound 1) → 2 (turn signal sound 2) → 1 (turn signal sound 1).

The setting changes to the selected turn-signal sound.

Changing the momentary fuel consumption display (Type 2)

N00563600039

It is possible to change the bar graph setting of the momentary fuel consumption display.

1. Press and hold the multi-information meter switch for about 2 seconds or more to switch from the setting mode screen to the menu screen.

Refer to “Changing the function settings (With ignition switch or operation mode is in ON)” on page 5-110.

2. Lightly press the multi-information meter switch to select (changing the momentary fuel consumption display)

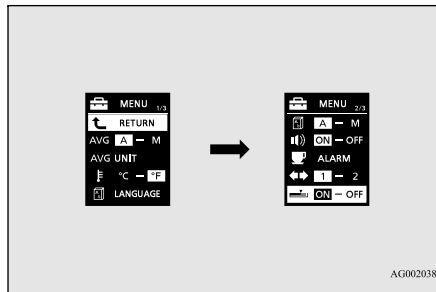

3. Press and hold the multi-information meter switch for about 2 seconds or more to switch in sequence from ON (with the green bar graph) → OFF (without the green bar graph) → ON (with the green bar graph).

The setting changes to the selected bar graph setting.

Returning to the factory settings

N00557600151

All of the function settings can be returned to their factory settings.

1. Press and hold the multi-information meter switch (for about 2 seconds or more) to switch from the setting mode screen to the menu screen.

Refer to “Changing the function settings (With ignition switch or operation mode is in ON)” on page 5-110.

2. Lightly press the multi-information meter switch to select “RESET” (return to the factory settings).

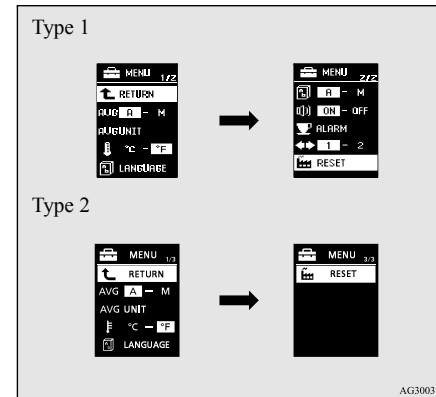

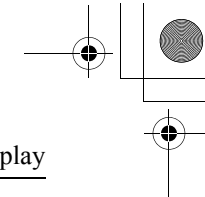

Multi-information display

3. Press and hold the multi-information meter switch (for about 5 seconds or more), the buzzer sounds and all of the function settings are returned to the factory settings.

NOTE

- The factory settings are as follows.
- Average fuel consumption and average speed reset mode: A (Auto reset)
- Fuel consumption display unit: mpg (US) or (L/100 km)
- Temperature unit: °F (Fahrenheit) or °C (Celsius)
- Display language: ENGLISH
- Cooperative language setting: A
- Operation sounds: ON (Operation sound on)
- “REST REMINDER” display: OFF
- Turn signal sound: Turn signal sound 1
- Momentary fuel consumption with the green bar graph (Type 2): ON

5

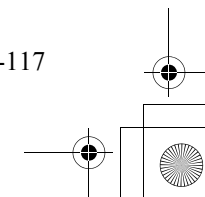
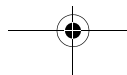
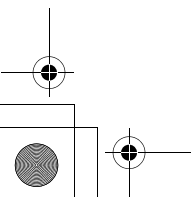
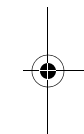
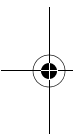

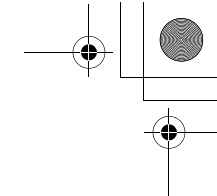
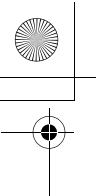

Indicator light, warning light, and information screen display list

Indicator light, warning light, and information screen display list

N0055770048

Indicator and warning light list

N00557801365

5

Type 1

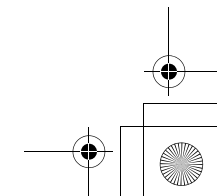
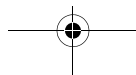
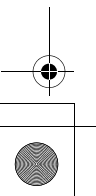
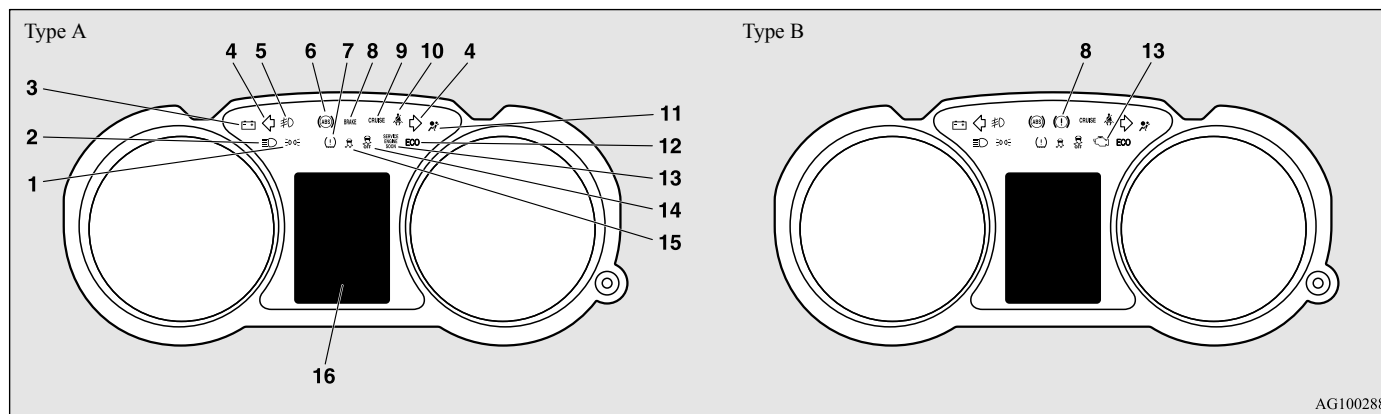

Indicator light, warning light, and information screen display list

Type 2

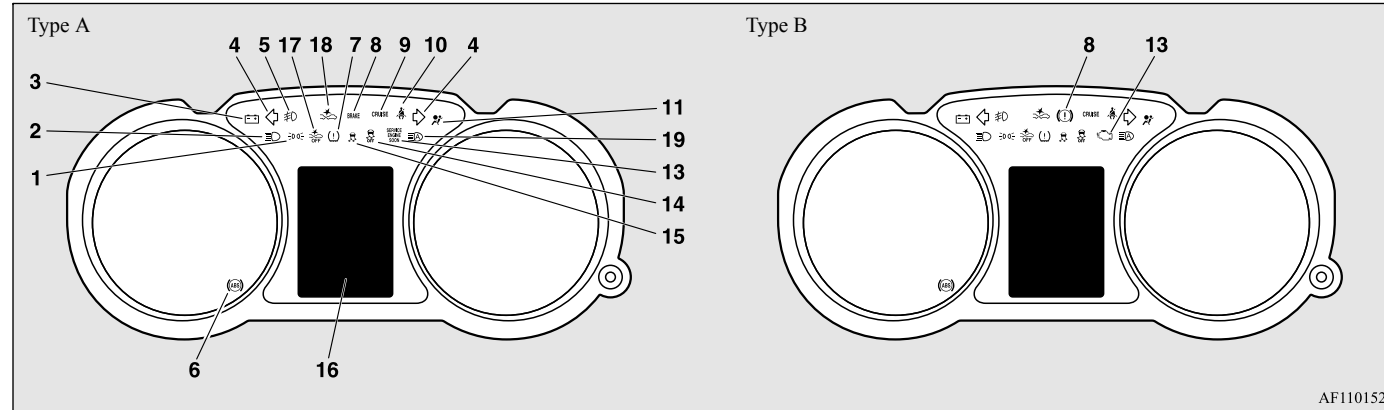

- | | | |
|---|--|--|
| <ul style="list-style-type: none"> 1- Position indicator → P.5-135 2- High beam indicator → P.5-135 3- Charging system warning light → P.5-137 4- Turn signal indicator/hazard warning light → P.5-135 5- Front fog light indicator (if so equipped) → P.5-135 6- Anti-lock braking system warning light → P.5-68 7- Tire pressure monitoring system warning light → P.5-90 8- Brake warning light → P.5-136 9- Cruise control indicator (if so equipped) → P.5-74 | <ul style="list-style-type: none"> 10- Seat belt reminder/warning light → P.4-16 11- Supplemental Restraint System (SRS) warning light → P.4-32 12- ECO mode indicator (if so equipped) → P.5-136 13- Engine malfunction indicator (“SERVICE ENGINE SOON” or “Check engine light”) → P.5-136 14- Active stability control (ASC) OFF indicator (if so equipped) → P.5-72 15- Active stability control (ASC) indicator → P.5-72 16- Information screen display list → P.5-120 | <ul style="list-style-type: none"> 17- Forward Collision Mitigation system (FCM) OFF indicator (if so equipped) → P.5-82 18- Forward Collision Mitigation system (FCM) indicator (if so equipped) → P.5-82 19- Automatic High Beam (AHB) indicator (if so equipped) → P.5-144 |
|---|--|--|

Indicator light, warning light, and information screen display list

Information screen display list

N00557900082

When there is information to be announced, such as light reminder, the tone sounds and the screen switches to the displays shown below. Refer to the appropriate page and take the necessary measures.

When the cause of the warning display is eliminated, the warning display goes out automatically.

Refer to “Warning display list (With ignition switch or operation mode is in OFF)” on page 5-120.

Refer to “Warning display list (With ignition switch or operation mode is in ON)” on page 5-123.

5

Refer to “Other interrupt displays” on page 5-132.

NOTE

- In the following cases, a warning may be displayed on the information screen and the buzzer may sound for a few seconds, at times.



This is caused by the system picking up interference such as strong electromagnetic waves or noise, and is not a functional problem.

- An extremely strong electromagnetic wave is received from a source such as an illegal radio set, a spark from a wire, or a radar station.
- Abnormal voltage or a static electricity discharge is generated by the operation of your vehicle’s electronics (including after-market parts).





If the warning display has occurred a number of times, take your vehicle to an authorized Mitsubishi Motors dealer or a repair facility of your choice and have the system checked.

Warning display list (With ignition switch or operation mode is in OFF)

N00558000224

Screen type 1	Screen type 2	Cause	Do this (Reference)
		<ul style="list-style-type: none"> • You have forgotten to remove the key from the ignition switch. 	<ul style="list-style-type: none"> • Remove the key. Refer to “Key reminder system” on page 5-29.







Indicator light, warning light, and information screen display list

Screen type 1	Screen type 2	Cause	Do this (Reference)
 TURN OFF LIGHTS	 TURN OFF LIGHTS	<ul style="list-style-type: none"> You have forgotten to turn off the lights. 	Refer to “Light auto-cutout function (headlights and other lights)” on page 5-141.
	 ALARM ACTIVATING	<ul style="list-style-type: none"> The theft-alarm system is operating. 	Refer to “Theft-alarm system” on page 5-34.
		<ul style="list-style-type: none"> Immobilizer is registered. 	Refer to “Customer key programming (Except for vehicles sold in Canada)” on page 5-5. Refer to “Customer F.A.S.T.-key programming (Except for vehicles sold in Canada)” on page 5-24.





5

Indicator light, warning light, and information screen display list

5

Screen type 1	Screen type 2	Cause	Do this (Reference)
—	 KEY BATTERY LOW  KEY NOT DETECTED  KEY STILL IN VEHICLE  CHECK DOORS  KEYLESS OPERATION SYSTEM SERVICE REQUIRED	<ul style="list-style-type: none"> There is a fault in the F. A. S. T. -key. 	Refer to “Free-hand Advanced Security Transmitter (F.A.S.T.-key)” on page 5-11.
—	 IMMOBILIZER SYSTEM SERVICE REQUIRED	<ul style="list-style-type: none"> There is a fault in the electronic immobilizer. (Anti-theft starting system). 	<ul style="list-style-type: none"> Contact an authorized Mitsubishi Motors dealer or a repair facility of your choice to have the system checked.



Indicator light, warning light, and information screen display list

Screen type 1	Screen type 2	Cause	Do this (Reference)
—	 KEY NOT DETECTED INSERT KEY INTO KEY SLOT IN GLOVE BOX	<ul style="list-style-type: none"> The F. A. S. T. -key is not detected. 	<ul style="list-style-type: none"> Insert the F. A. S. T. -key into the key slot in the glove compartment. Refer to “If the F. A. S. T. -key is not operating properly” on page 5-22.
—	 REMOVE KEY FROM KEY SLOT IN GLOVE BOX	<ul style="list-style-type: none"> You have forgotten to remove the F. A. S. T. -key from the key slot in the glove compartment. 	<ul style="list-style-type: none"> Remove the F. A. S. T. -key from the key slot in the glove compartment.
—	 SHIFT SHIFT TO P POSITION	<ul style="list-style-type: none"> The engine switch is pressed to stop the engine and the selector lever is in a position other than the “P” (PARK) position. 	<ul style="list-style-type: none"> On vehicles with CVT, place the selector lever in the “P” (PARK) position to put the operation mode in OFF.
—	 ELECTRICAL SYSTEM SERVICE REQUIRED	<ul style="list-style-type: none"> There is a fault in the electrical system. 	<ul style="list-style-type: none"> Park your vehicle in a safe place as soon as possible and contact an authorized Mitsubishi Motors dealer or a repair facility of your choice to have the system checked.

5







Warning display list (With ignition switch or operation mode is in ON)

N00558101378









Screen type 1	Screen type 2	Cause	Do this (Reference)
 LOW WASHER FLUID	 LOW WASHER FLUID	<ul style="list-style-type: none"> The washer fluid is running low. 	<ul style="list-style-type: none"> Replenish the container with washer fluid. Refer to “Washer fluid” on page 9-10. Refer to “Capacity” on page 11-5.

Indicator light, warning light, and information screen display list

5









Screen type 1	Screen type 2	Cause	Do this (Reference)
 SERVICE REQUIRED	 POWER STEERING SERVICE REQUIRED	<ul style="list-style-type: none"> ● There is a fault in the EPS. 	<ul style="list-style-type: none"> ● Have the vehicle inspected by an authorized Mitsubishi Motors dealer or a repair facility of your choice as soon as possible. Refer to “Electric power steering system (EPS)” on page 5-69.
—	 KEY BATTERY LOW	<ul style="list-style-type: none"> ● There is a fault in the F.A.S.T.-key. 	Refer to “Free-hand Advanced Security Transmitter (F.A.S.T.-key)” on page 5-11.
	 KEY NOT DETECTED		
	 KEY STILL IN VEHICLE		
	 CHECK DOORS		
	 KEYLESS OPERATION SYSTEM SERVICE REQUIRED		

Indicator light, warning light, and information screen display list



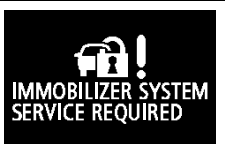







Screen type 1	Screen type 2	Cause	Do this (Reference)
		<ul style="list-style-type: none"> ● Immobilizer is registered. 	Refer to “Customer key programming (Except for vehicles sold in Canada)” on page 5-5. Refer to “Customer F.A.S.T.-key programming (Except for vehicles sold in Canada)” on page 5-24.
		<ul style="list-style-type: none"> ● The brake fluid level is low. ● There is a fault in the brake system. 	<ul style="list-style-type: none"> ● Park the vehicle in a safe place and inspect it. ● If the light still illuminates after the inspection, contact an authorized Mitsubishi Motors dealer or a repair facility of your choice for assistance. Refer to “Brake warning display” on page 5-137.
		<ul style="list-style-type: none"> ● There is a fault in the Anti-lock braking system. 	<ul style="list-style-type: none"> ● Avoid sudden braking and high-speed driving, park the vehicle in a safe place, and take corrective measures. Refer to “Anti-lock braking system warning” on page 5-68.
		<ul style="list-style-type: none"> ● The tire pressure in one of the tires (except spare tire) is low. 	Refer to “Tire Pressure Monitoring System” on page 5-89.
		<ul style="list-style-type: none"> ● There is a fault in the Tire Pressure Monitoring System. 	Refer to “Tire Pressure Monitoring System” on page 5-89.

5

Indicator light, warning light, and information screen display list











Screen type 1	Screen type 2	Cause	Do this (Reference)
		<ul style="list-style-type: none"> One of the doors or the liftgate is not completely closed. The open door is displayed. 	<ul style="list-style-type: none"> Close the door or liftgate. Refer to “Door ajar warning display screen (With ignition switch or operation mode is in ON)” on page 5-110.
5  CLOSE HOOD	 CLOSE HOOD	<ul style="list-style-type: none"> The engine hood is open. 	<ul style="list-style-type: none"> Close the engine hood. Refer to “Engine hood” on page 9-3.
—	 IMMOBILIZER SYSTEM SERVICE REQUIRED	<ul style="list-style-type: none"> There is a fault in the electronic immobilizer (Anti-theft starting system). 	<ul style="list-style-type: none"> Put the operation mode in OFF, and then start the engine again. If the warning is not cancelled, please contact an authorized Mitsubishi Motors dealer or a repair facility of your choice.
—	 OFF	<ul style="list-style-type: none"> The driver’s door is open when the operation mode is in any mode other than OFF. 	<ul style="list-style-type: none"> Put the operation mode in OFF. Refer to “Changing the operation mode” on page 5-17.
—	 ELECTRICAL SYSTEM SERVICE REQUIRED	<ul style="list-style-type: none"> There is a fault in the electrical system. 	<ul style="list-style-type: none"> Park your vehicle in a safe place as soon as possible and contact an authorized Mitsubishi Motors dealer or a repair facility of your choice to have the system checked.
 CHECK	 ENGINE OVERHEATING STOP SAFELY	<ul style="list-style-type: none"> The engine is overheated. 	<ul style="list-style-type: none"> Park the vehicle in a safe place and take corrective measures. Refer to “Engine overheating” on page 8-4.

Indicator light, warning light, and information screen display list





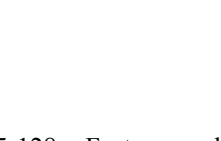



Screen type 1	Screen type 2	Cause	Do this (Reference)
 SLOW DOWN	 TRANSMISSION OVERHEATING SLOW DOWN	<ul style="list-style-type: none"> The CVT fluid temperature is increased. 	<ul style="list-style-type: none"> Park the vehicle in a safe place and take corrective measures. Refer to “Continuously variable transmission (CVT)” on page 5-51.
 FASTEN SEAT BELT	 FASTEN SEAT BELT	<ul style="list-style-type: none"> The seat belt is not fastened when the ignition switch or operation mode is in ON. 	<ul style="list-style-type: none"> Wear your seat belt properly. Refer to “Seat belt warning” on page 4-16.
 SERVICE REQUIRED	 FUEL SYSTEM SERVICE REQUIRED	<ul style="list-style-type: none"> There is a fault in the fuel system. 	<ul style="list-style-type: none"> Contact an authorized Mitsubishi Motors dealer or a repair facility of your choice to have the system checked.
 RELEASE PARKING BRAKE	 RELEASE PARKING BRAKE	<ul style="list-style-type: none"> The vehicle is being driven with the parking brake still applied. 	<ul style="list-style-type: none"> Release the parking brake. Refer to “Brake warning display” on page 5-137.
 CHECK	 LOW OIL PRESSURE	<ul style="list-style-type: none"> There is a fault in the engine oil circulation system. 	<ul style="list-style-type: none"> Park your vehicle in a safe place as soon as possible and contact an authorized Mitsubishi Motors dealer or a repair facility of your choice to have the system checked. Refer to “Oil pressure warning display” on page 5-138.

Indicator light, warning light, and information screen display list

5

Screen type 1	Screen type 2	Cause	Do this (Reference)
		<ul style="list-style-type: none"> ● There is a fault in the charging system. 	<ul style="list-style-type: none"> ● Park your vehicle in a safe place as soon as possible and contact an authorized Mitsubishi Motors dealer or a repair facility of your choice for assistance. Refer to “Charging system warning light” on page 5-137.
		<ul style="list-style-type: none"> ● There is a fault in the SRS airbag or the pre-tensioner system. 	<ul style="list-style-type: none"> ● Contact an authorized Mitsubishi Motors dealer or a repair facility of your choice to have the system checked, immediately. Refer to “SRS airbag/Pre-tensioner system warning” on page 4-32.
		<ul style="list-style-type: none"> ● There is a fault in the Active stability control (ASC). 	<ul style="list-style-type: none"> ● Contact an authorized Mitsubishi Motors dealer or a repair facility of your choice to have the system checked. Refer to “Active stability control (ASC)” on page 5-70.
		<ul style="list-style-type: none"> ● There is a fault in the Hill start assist. 	<ul style="list-style-type: none"> ● Have the vehicle checked at an authorized Mitsubishi Motors dealer or a repair facility of your choice. Refer to “Hill start assist” on page 5-65.
		<ul style="list-style-type: none"> ● There is a fault in the electronically controlled 4WD system. 	<ul style="list-style-type: none"> ● Contact an authorized Mitsubishi Motors dealer or a repair facility of your choice to have the system checked. Refer to “Electronically controlled 4WD system” on page 5-58.



Indicator light, warning light, and information screen display list

Screen type 1	Screen type 2	Cause	Do this (Reference)
 SERVICE REQUIRED	 TRANSMISSION SERVICE REQUIRED	<ul style="list-style-type: none"> There is a fault in the CVT. 	<ul style="list-style-type: none"> Contact an authorized Mitsubishi Motors dealer or a repair facility of your choice to have the system checked. Refer to “Continuously variable transmission (CVT)” on page 5-51.
 SLOW DOWN	 4WD SYSTEM OVERHEATING SLOW DOWN	<ul style="list-style-type: none"> The electronically controlled 4WD system is hot. 	<ul style="list-style-type: none"> Refer to “Electronically controlled 4WD system” on page 5-58.
 REFUEL	 REFUEL	<ul style="list-style-type: none"> The fuel is running low. 	<ul style="list-style-type: none"> Refuel as soon as possible. Refer to “Fuel remaining display screen” on page 5-108.
 POSSIBLE ICY ROADS	 POSSIBLE ICY ROADS	<ul style="list-style-type: none"> The outside temperature is 37 °F (3 °C) or less. 	<ul style="list-style-type: none"> Be careful driving on frozen ground. The ground may be frozen even when this warning is not displayed, so drive carefully.
—	 FCM! FCM SERVICE REQUIRED	<ul style="list-style-type: none"> There is a fault in the Forward Collision Mitigation system (FCM). 	<ul style="list-style-type: none"> Contact an authorized Mitsubishi Motors dealer or a repair facility of your choice to have the system checked. Refer to “System problem warning: FCM deactivation due to fault” on page 5-83.



5

Indicator light, warning light, and information screen display list

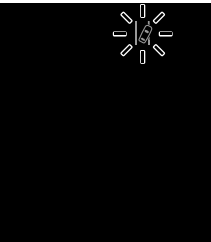
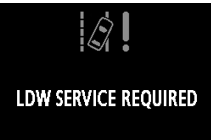
5

Screen type 1	Screen type 2	Cause	Do this (Reference)
—		<ul style="list-style-type: none"> ● FCM braking function of the Forward Collision Mitigation system (FCM) has been activated. 	Refer to “FCM braking function” on page 5-79.
—		<ul style="list-style-type: none"> ● The Forward Collision Mitigation system (FCM) is temporarily unavailable for some reason. This is not a malfunction. 	
—	 (flashing in yellow)	<ul style="list-style-type: none"> ● The Lane Departure Warning (LDW) has detected that your vehicle is about to leave or has left the lane. 	Refer to “Lane Departure Warning (LDW)” on page 5-86.
—		<ul style="list-style-type: none"> ● There is a fault in the Lane Departure Warning (LDW). 	<ul style="list-style-type: none"> ● Contact an authorized Mitsubishi Motors dealer or a repair facility of your choice to have the system checked. Refer to “Lane Departure Warning (LDW)” on page 5-86.

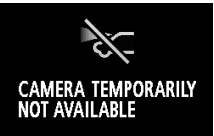
Indicator light, warning light, and information screen display list

Screen type 1	Screen type 2	Cause	Do this (Reference)
—		<ul style="list-style-type: none"> There is a fault in the sensor. 	<ul style="list-style-type: none"> Contact an authorized Mitsubishi Motors dealer. Refer to “Forward Collision Mitigation system (FCM): System problem warning” on page 5-83. Refer to “Lane Departure Warning (LDW): System problem warning” on page 5-88. Refer to “Automatic High Beam (AHB): System problem warning” on page 5-146.
—		<ul style="list-style-type: none"> The Forward Collision Mitigation system (FCM), Lane Departure Warning (LDW) and Automatic High Beam (AHB) is temporarily unavailable due to the high or low temperature of the sensor. 	<ul style="list-style-type: none"> After the temperature of the sensor has been in range, the system will automatically return to operation. Refer to “Forward Collision Mitigation system (FCM): System problem warning” on page 5-83. Refer to “Lane Departure Warning (LDW): System problem warning” on page 5-88. Refer to “Automatic High Beam (AHB): System problem warning” on page 5-146.
—		<ul style="list-style-type: none"> The sensor is temporarily unavailable due to conditions such as the adhesion of contaminants to the sensor or windshield. This is not a malfunction. 	<ul style="list-style-type: none"> Refer to “Forward Collision Mitigation system (FCM): System problem warning” on page 5-83. Refer to “Lane Departure Warning (LDW): System problem warning” on page 5-88. Refer to “Automatic High Beam (AHB): System problem warning” on page 5-146.



5

Indicator light, warning light, and information screen display list

Screen type 1	Screen type 2	Cause	Do this (Reference)
—		<ul style="list-style-type: none"> There is a fault in the system of Automatic High Beam (AHB). 	<ul style="list-style-type: none"> Contact an authorized Mitsubishi Motors dealer. Refer to “Automatic High Beam (AHB): System problem warning” on page 5-146.

5 Other interrupt displays

N00558201337







Screen type 1	Screen type 2	System operation status	Reference
—		<ul style="list-style-type: none"> When starting the engine, you pressed the engine switch without depressing the clutch pedal (manual transaxle). 	<ul style="list-style-type: none"> On vehicles with manual transaxle, place the gearshift lever in the “N” (Neutral) position, fully depress the clutch pedal, depress and hold the brake pedal with the right foot, and then press the engine switch to start the engine. Refer to “Starting and stopping the engine” on page 5-20.
—		<ul style="list-style-type: none"> When starting the engine, the selector lever is in a position other than the “P” (PARK) or the “N” (NEUTRAL) position, or you pressed the engine switch without depressing the brake pedal (CVT). 	<ul style="list-style-type: none"> On vehicles with CVT, place the selector lever in the “P” (PARK) position, depress and hold the brake pedal with the right foot, and then press the engine switch to start the engine. Refer to “Starting and stopping the engine” on page 5-20.

Indicator light, warning light, and information screen display list

The operation status of each system is displayed on the information screen. For further details, refer to the appropriate page for each system.

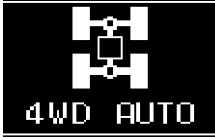
NOTE



- When operating each system, confirm that the operation status of the system has changed on the information screen. However, the operation status of the system may not be displayed immediately after the warning display appears even if the system is operated.

Screen type 1	Screen type 2	System operation status	Reference
		● When “2WD” drive mode is selected with the drive mode selector.	Refer to “Electrically controlled 4WD system” on page 5-58.
		● When “4WD AUTO” mode is selected with the drive mode selector.	
		● When “4WD LOCK” mode is selected with the drive mode selector.	
		● When the Active stability control (ASC) is operating.	Refer to “Active stability control (ASC)” on page 5-70.

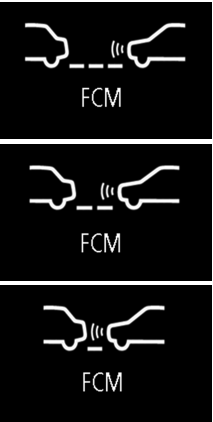

5

Indicator light, warning light, and information screen display list

5



Screen type 1	Screen type 2	System operation status	Reference
—	 <p>FCM</p> <p>FCM</p> <p>FCM</p>	<ul style="list-style-type: none"> When the Forward Collision Mitigation system (FCM) is activated or the timing of an alarm is changed. 	Refer to “FCM ON/OFF switch” on page 5-82.
—	 <p>OFF</p>	<ul style="list-style-type: none"> When the Forward Collision Mitigation system (FCM) is deactivated. 	Refer to “FCM ON/OFF switch” on page 5-82.

This informs you that a periodic inspection is due.

Screen type 1	Screen type 2	Do this
 <p>PERIODIC INSPECTION</p>	 <p>ROUTINE MAINTENANCE REQUIRED</p>	Have an inspection made by an authorized Mitsubishi Motors dealer. For further details, refer to “Service reminder” on page 5-108.

Indicators

The rest time can be set.

Screen type 1	Screen type 2	Do this
		<p>Park the vehicle in a safe place, turn off the engine, and take a rest. Use this display as rough guide for taking rests during a long drive. The interval from the start of your trip until this message is displayed can be set. Refer to “Changing the function settings (With the ignition switch or operation mode is in ON)” on page 5-110.</p> <p>The display and buzzer alert the driver when the set time is reached. If you continue to drive without having a rest, the buzzer sounds about every 5 minutes to encourage you to take a rest.</p> <ul style="list-style-type: none"> • In the following cases, the time driven is reset and the display returns to the previous display screen. After this, when the set time is reached again, the display and buzzer encourage you to take a rest. <ul style="list-style-type: none"> • The buzzer sounds 3 times. • The ignition switch is turned to the “OFF” position or the operation mode is put in OFF. • The multi-information meter switch is held (for about 2 seconds or more).

5

Indicators

N00519900127

Turn signal indicators/Hazard warning lights

N00520000216

The arrows will flash in time with the corresponding exterior turn signals when the turn signal lever is used.

Both arrows will flash when the hazard warning flasher switch is pressed.

NOTE

- If the indicator flashes faster than usual or if the indicator stays on without flashing, check for a malfunctioning turn signal light bulb or turn signal connection.

High beam indicator

N00520100086

A blue light comes on when the headlights are on high beam.

Front fog light indicator (if so equipped)

N00520200175

This indicator comes on while the front fog lights are on.

Position indicator

N00551301081

This indicator light illuminates while the parking lights are on.

Warning lights

ECO mode indicator (if so equipped)

N0056880023

This indicator will be displayed when fuel-efficient driving is achieved.

5

Warning lights

N00520300147

Brake warning light

N00520400470

This light comes on when the ignition switch is turned to the “ON” position (engine off) or the operation mode is put in ON.

When the engine is started, the light should go off a few seconds later. A warning is also displayed in the multi-information display.

The warning light also illuminates after starting the engine under the following conditions.

- When the parking brake is still applied.
- When the brake fluid level is low.
- When the brake system circuit is not working properly.

Before driving, be sure that the parking brake is fully released and brake warning light is off.

5-136 Features and controls

CAUTION

- If the brake warning light and the Anti-lock braking system warning light are illuminated at the same time, the braking force distribution function will not operate, so the vehicle may be destabilized during sudden braking under the following conditions.
 - When the brake warning light does not go out even when the parking brake is released.
 - When the brake warning light stays on while driving.
 - If the above occurs, avoid sudden braking and high-speed driving. Park the vehicle in a safe place, and contact an authorized Mitsubishi Motors dealer or a repair facility of your choice as soon as possible.
- The vehicle should be brought to a halt in the following manner when brake performance is deteriorated.
 - Confirm that the vehicle slows down when you press down on the brake pedal harder than usual. In some cases, the brake pedal may go all the way to the floor.
 - Should the brakes fail, use engine braking to reduce your speed and slowly apply the parking brake. Depress the brake pedal to illuminate the stop lights to alert the vehicles behind you.

Engine malfunction indicator (“SERVICE ENGINE SOON” or “Check engine light”)

N00520500804

This indicator is a part of the onboard diagnostic (OBD) system which monitors the emissions, engine control system or continuously variable transmission (CVT) control system. If a problem is detected in one of these systems, this indicator illuminates or flashes. When the ignition switch is turned to the “ON” position or the operation mode is put in ON, this indicator normally comes on and goes off after the engine has started.

This indicator will come on if the fuel tank filler cap is not properly tightened. If this indicator comes on and stays on after refueling, stop the engine and check that the cap is properly tightened. (Turn the cap clockwise until you hear clicking sounds.)

If this indicator does not go off after several seconds or lights up while driving, have the system checked as soon as possible at an authorized Mitsubishi Motors dealer or a repair facility of your choice.

Information screen display

CAUTION

- Driving for a long time with the engine malfunction indicator on may cause more damage to the emission control system. This could also affect fuel economy and drivability.
- If this indicator does not come on when the ignition switch is turned to the “ON” position or the operation mode is put in ON, have the system checked at an authorized Mitsubishi Motors dealer or a repair facility of your choice.
- If the engine malfunction indicator comes on while the engine is running, avoid driving at high speeds.
During vehicle operation with the indicator on, the vehicle may not accelerate when you depress the accelerator pedal.
When the vehicle is stationary with the indicator on, you must depress the brake pedal more firmly than usual since the engine idling speed is higher than usual and a vehicle with a CVT has a stronger tendency to creep forward.

NOTE

- Do not disconnect the battery cable when the engine malfunction indicator (“SERVICE ENGINE SOON” or “Check engine light”) is on.
The engine electronic control module stores critical OBD information (especially exhaust emission data), which may be lost if the battery cable is disconnected while the engine malfunction indicator is on. This will make it difficult to diagnose the cause of future problems.

Charging system warning light

N00520600300

This light comes on in the event of a malfunction in the charging system or when the ignition switch is turned to the “ON” position (engine off) or the operation mode is put in ON. A warning is also displayed in the multi-information display. When the engine is started, the light should go out. Check to make sure that the light has gone out before driving.

CAUTION

- If the warning light stays on while the engine is running, park your vehicle in a safe place as soon as possible and contact an authorized Mitsubishi Motors dealer or a repair facility of your choice to have the system checked.

Information screen display

N00558300038

Brake warning display

N00558400143

Type 1



5

Type 2



This warning is displayed if the vehicle is being driven with the parking brake still applied. The warning light in the instrument cluster only comes on when the parking brake is applied.

CAUTION

- If a vehicle is driven without releasing the parking brake, the brakes will overheat, resulting in ineffective braking and possible brake failure.
If this warning is displayed, release the parking brake.

Information screen display

Type 1



Type 2



When the ignition switch is turned to the “ON” position or the operation mode is put in ON, if the brake fluid is low, this warning is displayed.

The warning light in the instrument cluster also illuminates.

CAUTION

- If this warning stays on and does not go out while driving, there is a danger of ineffective braking. If this happens, park the vehicle in a safe place, and contact an authorized Mitsubishi Motors dealer or a repair facility of your choice.

CAUTION

- If the brake warning display, brake warning light, and the Anti-lock braking system warning light are illuminated at the same time, the braking force distribution function will not operate, so the vehicle may be destabilized during sudden braking. Avoid sudden braking and high-speed driving. Park the vehicle in a safe place, and contact an authorized Mitsubishi Motors dealer or a repair facility of your choice.
 - The vehicle should be brought to a halt in the following manner when brake performance is deteriorated.
 - Confirm that the vehicle slows down when you press down on the brake pedal harder than usual. In some cases, the brake pedal may go all the way to the floor.
 - Should the brakes fail, use engine braking to reduce your speed and slowly apply the parking brake.
- Depress the brake pedal to illuminate the stop lights to alert the vehicles behind you.

Charging system warning display

N00558600103

Type 1



Type 2



If there is a fault in the charging system, the warning display warning is displayed on the information screen in the multi-information display. The warning light in the instrument cluster also illuminates.

CAUTION

- If warnings are displayed while the engine is running, park your vehicle in a safe place as soon as possible and contact an authorized Mitsubishi Motors dealer or a repair facility of your choice to have the system checked.

Oil pressure warning display

N00558700090

Type 1



Combination headlights and dimmer switch

Type 2



If the engine oil pressure drops while the engine is running, the warning display is displayed on the information screen in the multi-information display.

CAUTION

- If the vehicle is driven while the engine oil is low, or the oil level is normal but the warning is displayed, the engine may overheat and damage may result.
- If the warning is displayed while the engine is running, park your vehicle in a safe place as soon as possible and check the engine oil level.
- If this warning display comes on when the engine oil level is proper, have your vehicle checked at an authorized Mitsubishi Motors dealer or a repair facility of your choice.

NOTE

- The oil pressure warning display does not show the amount of oil. The oil level must be checked using the dipstick.

Combination headlights and dimmer switch

N00522501919

Headlights

NOTE

- Do not leave the headlights and other lights on for a long period of time when the engine is not running. The battery will run down.
- When it rains, or when the vehicle has been washed, the inside of the lens sometimes becomes foggy. This is the same as when window glass mists up on a humid day, and does not indicate a problem. When the light is switched on, the heat will dry out the fog. However, if water collects inside the light, have it checked by an authorized Mitsubishi Motors dealer or a repair facility of your choice.
- High intensity discharge headlights (if so equipped) have the following characteristics:
 - The light will gradually change to bluish white as the headlights are used.
 - The life of the high intensity discharge headlight bulbs will decrease over time if frequently turned on/off.
 - If a high intensity discharge headlight bulb becomes dull, turns reddish, or begins to flash, it must be replaced.

NOTE

Contact an authorized Mitsubishi Motors dealer or a repair facility of your choice whenever it is necessary to repair the high intensity discharge headlight or to replace the bulb.

Type 1

5

Rotate the switch to operate the lights.

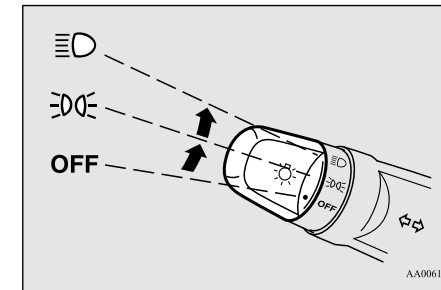

The combinations of switch operations and illuminated lights differ in accordance with the following conditions.

Except for vehicles equipped with daytime running lights

OFF | All lights off

Combination headlights and dimmer switch

☰☱	Parking, tail, front and rear side-marker lights, license plate and instrument panel lights on
☰☱☲	Headlights and other lights on

5 Vehicles equipped with daytime running lights

[When the engine is started after the parking brake is released]

OFF	The daytime running lights illuminated
☰☱	The daytime running lights illuminated Tail, front and rear side-marker lights, license plate and instrument panel lights on
☰☱☲	Headlights and other lights on

NOTE
<ul style="list-style-type: none"> Once the daytime running light come on, they do not go out until the ignition switch is turned to the "OFF" or "ACC" position or the operation mode is changed to OFF or ACC.

[When the engine is not running, or when the engine is started before the parking brake is released]

5-140 Features and controls

OFF	All lights off
☰☱	Parking, tail, front and rear side-marker lights, license plate and instrument panel lights on
☰☱☲	Headlights and other lights on

NOTE
<ul style="list-style-type: none"> Even if the daytime running lights are not on, they will come on once the vehicle starts moving. Once the daytime running light come on, they do not go out until the ignition switch is turned to the "OFF" or "ACC" position or the operation mode is changed to OFF or ACC.

Type 2

Rotate the switch to operate the lights.

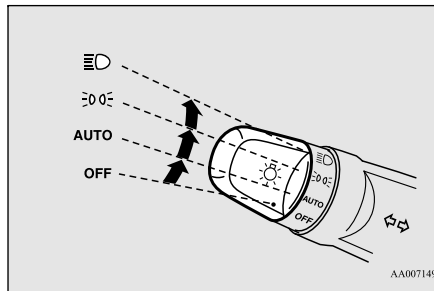

The combinations of switch operations and illuminated lights differ in accordance with the following conditions.

Except for vehicles equipped with daytime running lights



OFF	All lights off
AUTO	Headlights and other lights turn on and off automatically in accordance with outside light level.
☰☱	Parking, tail, front and rear side-marker lights, license plate and instrument panel lights on
☰☱☲	Headlights and other lights on

Vehicles equipped with daytime running lights

[When the engine is started after the parking brake is released]



OFF	The daytime running lights illuminated
AUTO	The daytime running lights illuminated (when it is light outside the vehicle) Headlights and other lights turn on and off automatically in accordance with outside light level.

Combination headlights and dimmer switch

	The daytime running lights illuminated Tail, front and rear side-marker lights, license plate and instrument panel lights on
	Headlights and other lights on

NOTE	
<ul style="list-style-type: none"> Once the daytime running light come on, they do not go out until the ignition switch is turned to the "OFF" or "ACC" position or the operation mode is changed to OFF or ACC. 	

[When the engine is not running, or when the engine is started before the parking brake is released]

OFF	All lights off
AUTO	Headlights and other lights turn on and off automatically in accordance with outside light level.
	Parking, tail, front and rear side-marker lights, license plate and instrument panel lights on
	Headlights and other lights on

NOTE

- Even if the daytime running lights are not on, they will come on once the vehicle starts moving.
- Once the daytime running light come on, they do not go out until the ignition switch is turned to the "OFF" or "ACC" position or the operation mode is changed to OFF or ACC.
- The sensitivity of the automatic on/off control can be adjusted.
For further information, please contact your authorized Mitsubishi Motors dealer or a repair facility of your choice.
- Do not cover the sensor (A) for the automatic on/off control by affixing a sticker or label to the windshield.

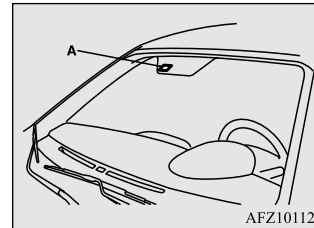

- If the lights do not turn on or off with the switch in the "AUTO" position, manually operate the switch. Have the system checked by an authorized Mitsubishi Motors dealer or a repair facility of your choice.

Light auto-cutout function (headlights and other lights)

N00532601593

- If the following operation is performed with the combination headlights and dimmer switch in the "OFF" or "ACC" position, the lights automatically turn off.

5

[Except for vehicles equipped with the F.A.S.T.-key]

The ignition switch is turned to the "OFF" or "ACC" position or the key is removed from the ignition switch and the driver's door is opened.

[For vehicles equipped with the F.A.S.T.-key]

The operation mode is changed to OFF or ACC and the driver's door is opened.

When using a key to start the engine

- If the driver's door is opened after the key is removed from the ignition switch, a high-pitched constant tone will sound to remind you to turn off the lights.
- If the driver's door is opened with the key in the ignition switch, a low-pitched beep will sound to remind you to remove the key.

When using the F.A.S.T.-key to start the engine

Features and controls 5-141

Combination headlights and dimmer switch

5

- If the operation mode is put in OFF and the driver's door is opened, a high-pitched constant buzzer will sound to remind you to turn off the lights.
- If the operation mode is changed to any mode other than OFF and the driver's door is opened, a low-pitched constant buzzer will sound to remind you to put the operation mode in OFF.

- If the following operation is performed with the combination headlights and dimmer switch in the “

[Except for vehicles equipped with the F.A.S.T.-key]

The ignition switch is turned to the “OFF” or “ACC” position or the key is removed from the ignition switch and the driver's door is not opened.

[For vehicles equipped with the F.A.S.T.-key]

The operation mode is changed to OFF or ACC and the driver's door is not opened.

NOTE

- The light auto-cutout function can be deactivated. See your authorized Mitsubishi Motors dealer for details.

When you want to keep the lights on:

If the combination headlights and dimmer switch is turned to the “

NOTE

- When the engine is started using the key, if the driver's door is opened and the key is removed, the headlight reminder buzzer intermittently emits a high-pitched sound. If the key is still in the ignition switch the key reminder buzzer intermittently emits a low-pitched sound. The buzzer stops when the driver's door is closed. (A warning is also displayed in the multi-information display.)

NOTE

- When the engine is started using the F.A.S.T.-key, if the driver's door is opened and the operation mode is put in OFF, the headlight reminder buzzer intermittently emits a high-pitched sound. If the operation mode is in any mode other than OFF, the operation mode on reminder buzzer intermittently emits a low-pitched sound. The buzzer stops when the driver's door is closed. (A warning is also displayed in the multi-information display.)

Headlight reminder buzzer

N00549800226

[When using a key to start the engine]

If the driver's door is opened with the key in the “OFF” or “ACC” position or removed from the ignition switch while the lights are on, the tone will sound to remind you to turn off the lights.

[When using the F.A.S.T.-key to start the engine]

If the driver's door is opened with the operation mode is put in OFF or ACC, or if the operation mode is changed to OFF while the lights are on, the tone will sound to remind you to turn off the lights.

In either case, the lights will turn off automatically and so will the tone. Or you can turn

the light switch to the “OFF” position to stop the tone.

Dimmer (high/low beam change)

N00549900142

To change the headlights from high beam to low beam and vice versa, pull the turn signal lever to (1). Switch the headlights to low beam as a courtesy whenever there are oncoming vehicles, or when there is traffic moving ahead of you. An illuminated blue light in the instrument cluster indicates when the headlights are on high beam.

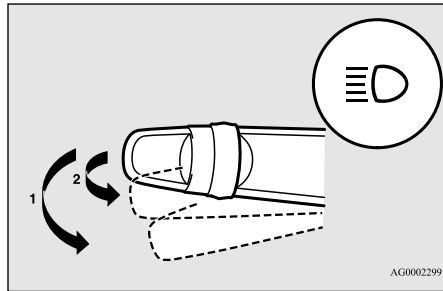

AG0002299

Headlight flasher

N00550000185

You can flash the high beams by pulling the lever gently toward you (2). The lights will

go back to normal when you let go. While the high beam is on, you will see a blue light on the instrument panel.

NOTE

- You can flash the high beams by pulling the lever toward you, even if the light switch is off.
- If you turn the lights off with the head lights set to high-beam illumination, the headlights are automatically returned to their low-beam setting when the light switch is next turned to the “D” position.

Combination headlights and dimmer switch

Automatic High Beam (AHB) (if so equipped)

N00591300057

The Automatic High Beam (AHB) turns the high beam light on or off automatically according to surrounding light conditions. The sensor (A) detects lights, such as the lights of an oncoming vehicle, a vehicle ahead or street lights.

For details about handling the sensor, refer to “Handling of the sensor” on page 5-85.

5

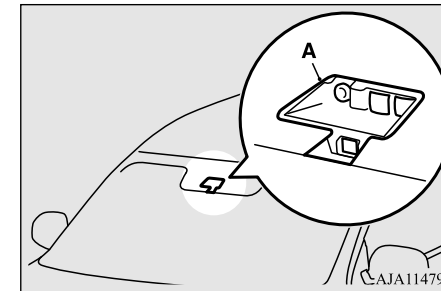

WARNING

- Do not rely solely on the Automatic High Beam (AHB). Always observe surrounding traffic and light conditions. If necessary, manually turn the high beams on or off. Refer to “Dimmer (high/low beam change)” on page 5-143.

Combination headlights and dimmer switch

How to use the Automatic High Beam (AHB)

N00593600041

1. Rotate the light switch to “D” position or “AUTO” position when the engine is running.

5

NOTE

- If the headlights are on when the light switch is in the “AUTO” position, the Automatic High Beam (AHB) works.

2. Press the Automatic High Beam (AHB) switch.

The Automatic High Beam (AHB) is activated and the indicator is illuminated.

If the Automatic High Beam (AHB) switch is pressed again, the Automatic High Beam (AHB) will be deactivated and Automatic High Beam (AHB) indicator will go off.

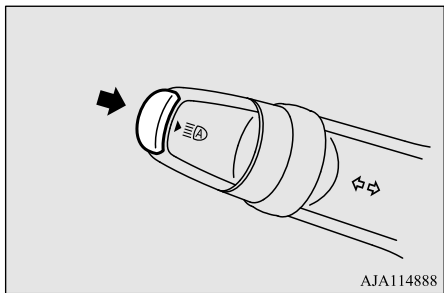

AJA114888

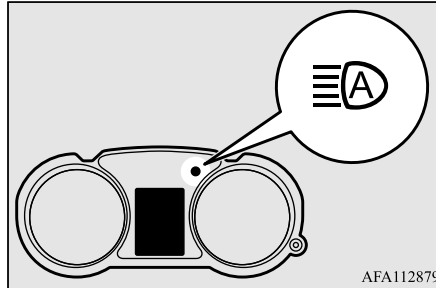

AFA112879

NOTE

- You can switch the headlight beams (high/low) manually by operating the lever even if the Automatic High Beam (AHB) is working. Refer to “Dimmer (high/low beam change)” on page 5-143. If the lever is operated manually, the Automatic High Beam (AHB) indicator will go off and the Automatic High Beam (AHB) will be deactivated. Refer to “Manual switching” on page 5-144.
- The Automatic High Beam (AHB) is not deactivated when you pull the lever slightly (operation of the headlight flasher).

Manual switching

Switching to low beam

1. Pull the turn signal lever toward you.

2. The Automatic High Beam (AHB) indicator will go off.
3. The Automatic High Beam (AHB) switch is pressed again, the Automatic High Beam (AHB) will be activated.

Switching to high beam

1. Pull the turn signal lever toward you.
2. The Automatic High Beam (AHB) indicator will go off and the high beam indicator illuminates.
3. The Automatic High Beam (AHB) switch is pressed again, the Automatic High Beam (AHB) will be activated.

Automatic switching conditions

N00593700042

The high beam headlights illuminate when all of the following conditions are met:

- Your vehicle speed exceeds approximately 33 mph (53 km/h).
- It is dark ahead of your vehicle.
- There are no vehicles in front or oncoming vehicles, or none of their exterior lights are illuminating.

The low beam headlights illuminate when any of the following conditions occur:

Combination headlights and dimmer switch

- Your vehicle speed does not exceed approximately 28 mph (45 km/h).
- It is bright ahead of your vehicle.
- An exterior light of a vehicle in front or oncoming vehicle is illuminating.

NOTE

- The headlights may not be switched from high beam to low beam under the following circumstances.
 - A vehicle in front or oncoming vehicle is hindered by any object such as continuous bends, elevated median/island, traffic signs, roadside trees.
 - Your vehicle passes an oncoming vehicle suddenly on a bend with poor visibility.
 - Another vehicle crosses ahead of your vehicle.
- The headlights may remain at low beam (or be switched from high beam to low beam) when a reflective object (e.g. street light, traffic signal, noticeboard and signboard) reflects light.
- Any of the following factors may influence the headlight beam switching timing:
 - How brightly the exterior lights of a vehicle in front or oncoming vehicle illuminate.
 - Movement or direction of a vehicle in front or oncoming vehicle.
 - Only right or left exterior light of a vehicle in front or oncoming vehicle is illuminating.

NOTE

- A vehicle in front or oncoming vehicle is a motorcycle.
- Road conditions (gradient, bends and road surface).
- The number of occupants and luggage load.
- The Automatic High Beam (AHB) recognises environmental conditions by sensing a light source ahead of your vehicle. Therefore, you may feel like something is not quite right when the headlight beams are switched automatically.
- The system may not detect a light vehicle such as a bicycle.
- The system may not detect an ambient brightness precisely. This causes the traffic to be dazzled by high beam or the low beam to be maintained. In such cases, you should switch the headlight beams manually.
 - In bad weather (heavy rain, fog, snow or sandstorm).
 - The windshield is dirty or fogged up.
 - The windshield is cracked or broken.
 - The sensor is deformed or dirty.
- A light, which is similar to the headlights or tail lights, is shining around your vehicle.
- A vehicle in front or oncoming vehicle is driven without lights, the exterior lights are dirty or discoloured, or the direction of the headlight beams is adjusted improperly.
- It becomes dark and bright suddenly and continuously around your vehicle.
- Your vehicle is driven on uneven surfaces.

NOTE

- Your vehicle is driven on a winding road.
- A reflective object such as a noticeboard or a mirror reflects a light ahead of your vehicle.
- When lights of the vehicle in front or headlights of an oncoming vehicle blend into the other lights.
- The rear end of a vehicle in front (such as a container truck) reflect a strong light.
- Your vehicle's headlight is broken or dirty.
- Your vehicle is inclined due to a flat tire or towing.
- The warning display appears. (Refer to "System problem warning" on page 5-146.)
- Observe the precautions below to maintain good usage conditions:
 - Do not attempt to disassemble the sensor.
 - Do not affix a sticker or label on the windshield near the sensor.
 - Avoid overload.
 - Do not modify your vehicle.
 - When the windshield is replaced, use the Mitsubishi Motors genuine parts.

5

To adjust the sensitivity of the sensor

The sensitivity of the sensor can be temporarily lowering in the following ways.

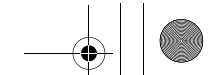

Combination headlights and dimmer switch

1. Park your vehicle in a safe place and the ignition switch is turned to the “OFF” position or the operation mode is put in OFF.
2. Press the Automatic High Beam (AHB) switch more than 15 times within 5 seconds after operation mode is turned on.

5

System problem warning

N00593800043

If a problem occurs with the system, the following warning display will appear to the type of the problem.

■ The Automatic High Beam (AHB) deactivation due to fault

If a failure is detected in the system, the following warning display will appear and the Automatic High Beam (AHB) will automatically be turned off.

If the warning display remains even after the ignition switch is turned to the “OFF” position or the operation mode is put in OFF and then turned back to ON, please contact an authorized Mitsubishi Motors dealer.

[When the Automatic High Beam (AHB) is malfunctioning]



[When the sensor is malfunctioning]



NOTE

- If the sensor or its surrounding area becomes extremely high temperature when parking the vehicle under a blazing sun, the “AHB SERVICE REQUIRED” warning display may appear. If the message remains even after the temperature of the sensor or its surrounding area has been in range, please contact an authorized Mitsubishi Motors dealer.

■ Sensor is too hot or cold

If the system becomes temporarily unavailable due to the high or low temperature of the sensor, the following warning display will appear.

After the temperature of the sensor has been in range, the system will automatically return to operation.

If the warning display does not disappear after waiting for a while, there is a possibility that the Automatic High Beam (AHB) has a malfunction. Contact an authorized Mitsubishi Motors dealer for inspection of the system.

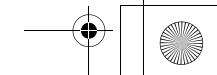
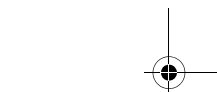
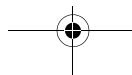
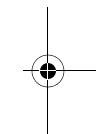
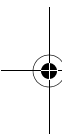

Combination headlights and dimmer switch

■ Windshield is dirty

If the Automatic High Beam (AHB) determines that its performance has been degraded, the warning display will appear. This can occur when

- Foreign objects, such as dirt, snow or ice, adhere to the windshield of the sensor portion.
- In adverse weather conditions, such as rain, snow, sand storms, etc.
- A front vehicle or an oncoming vehicle is splashing water, snow or dirt.

When the sensor performance returns, the Automatic High Beam (AHB) will resume operation.

If the warning display does not disappear after waiting for a while, there is a possibility that the sensor has a malfunction. Contact an authorized Mitsubishi Motors dealer for inspection of the sensor.



CAMERA BLOCKED

Welcome light

N00563201247

This function turns on the front side-marker and parking lights for about 30 seconds after the UNLOCK button (A) on the remote control transmitter is pressed when the combination headlights and dimmer switch is in the “OFF” or “AUTO” position (for vehicles equipped with the automatic light control). On vehicles equipped with the automatic light control, the welcome light function will operate only when it is dark outside the vehicle.

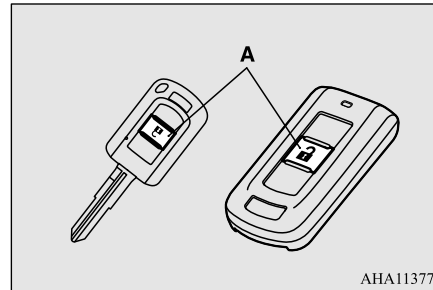

AHA113771

NOTE

- While the welcome light function is operating, perform one of the following operations to cancel the function.

NOTE

- Push the LOCK button (B) on the remote control transmitter.

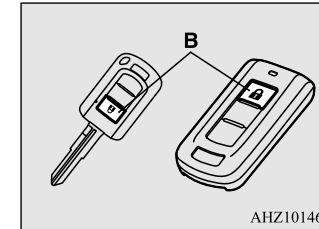

AHZ101463

- Turn the combination headlights and dimmer switch to the “OFF” or “AUTO” position.
 - Turn the ignition switch to the “ON” position or put the operation mode in ON.
 - It is possible to modify functions as follows:
 - The headlights can be set to come on in the low beam setting.
 - The welcome light function can be deactivated.
- For details, consult a Mitsubishi Motors dealer.

5

Coming home light

N00547301123

This function turns on the headlights in the low beam setting for about 30 seconds after the ignition switch is turned to the “OFF” position or the operation mode is put in OFF.

Headlight leveling switch (if so equipped)

5

1. Turn the combination headlights and dimmer switch to the “OFF” or “AUTO” position (for vehicles equipped with the automatic light control).
2. Turn the ignition switch to the “OFF” position or put the operation mode in OFF. Also, if a key was used to start the engine, remove the key from the ignition switch.
3. Within 60 seconds of turning the ignition switch to the “OFF” position or putting the operation mode in OFF, pull the turn signal lever toward you.
4. The headlights will come on in the low beam setting for about 30 seconds. After the headlights go off, the headlights can be turned on again in the low beam setting for about 30 seconds by pulling the turn signal lever toward you within 60 seconds of turning the ignition switch to the “OFF” position or putting the operation mode in OFF. To turn on the headlights again after 60 seconds of turning the ignition switch to the “OFF” position or putting the operation mode in OFF, repeat the process from step 1.

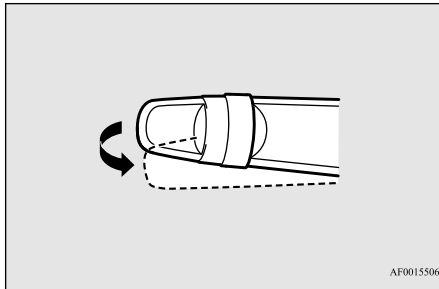

NOTE

- While the coming home light function is operating, perform one of the following operations to cancel the function.
 - Pull the turn signal lever toward you.
 - Turn the combination headlights and dimmer switch to the “OFF” or “AUTO” position or put the operation mode in ON.
 - Turn the ignition switch to the “ON” position or put the operation mode in ON.
 - It is possible to modify functions as follows:
 - The time that the headlights remain on can be changed.
 - The coming home light function can be deactivated.
- For details, consult a Mitsubishi Motors dealer.

Headlight leveling switch (if so equipped)

N00537100105

The direction of the headlight beam (the direction in which the light shines) alters according to the number of people and the load in the vehicle. Lower the headlight angle if it is too high due to the number of people and/or the load in the vehicle so that the headlights’ glare does not distract the drivers of approaching vehicles. First set the light switch to the “” position, then turn the headlight leveling switch knob to lower the beam. The greater the number on the headlight leveling switch knob, the lower the beam will point.

Set the switch to the appropriate position so that the headlight beam is level with the road.

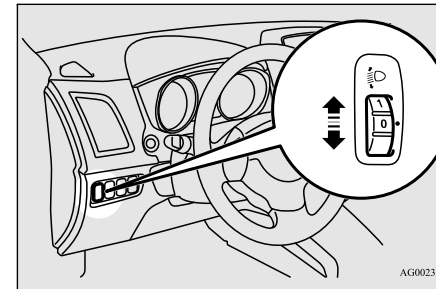

Turn signal lever

⚠ WARNING

- To avoid distraction while driving, always perform headlight adjustments before vehicle operation.

📖 NOTE

- Start adjusting when the knob is at the “0” position (when the beam is at its highest).
- Keep the knob in the “0” position except when using the knob to lower the headlight beam angle.
- Always return the knob to the “0” position when the load is removed and the people have left the vehicle.

Turn signal lever

N00522601532

When changing lanes, or to making a gradual turn, hold the lever in the “lane change” position (1). It will return to the neutral position when you let go. Use the full position (2) when making a normal turn. The lever will return to the neutral position when the turn is complete. There may be times when the lever does not return to the neutral position. This usually happens when the steering wheel is turned only slightly. You can easily return the lever by hand.

Also, when you move the lever to (1) slightly then release it, the turn signal lights and the

indicator light in the instrument cluster will flash three times.

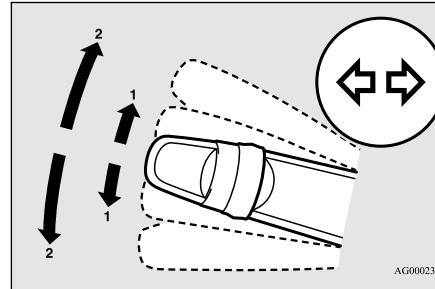

📖 NOTE

- A light in the instrument panel flashes to show when the front and rear turn signal lights are working properly. If this light flashes faster than usual, check for a burned out turn signal light bulb or malfunctioning connection in the signal. If the panel light does not come on when the lever is moved, check for a blown fuse or a burned out bulb in the panel. Have the system inspected by your authorized Mitsubishi Motors dealer or a repair facility of your choice.
- It is possible to modify functions as follows:
 - Deactivate the turn signal light 3-flash function for lane changes.

📖 NOTE

- Adjust the time required to operate the lever for the 3-flash function. See your authorized Mitsubishi Motors dealer for details.

Hazard warning flasher switch

N00522700275

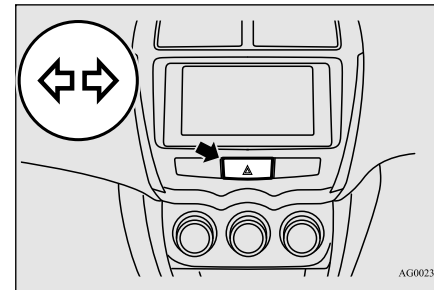

If you press the flasher switch, the front and rear turn signals will flash intermittently, and so will the hazard warning lights. This is an emergency warning system and should not be used when the vehicle is in motion, except for emergencies.

If you need to leave your vehicle, the flashers will keep working after the ignition switch is removed or the operation mode is put in OFF.

5

Front fog light switch (if so equipped)

NOTE

- If the flashers are used for several hours, the battery will run down. This could make it difficult or impossible to restart your vehicle.

5

Front fog light switch (if so equipped)

N00522800393

The front fog lights illuminate only when the headlights are on low beam.

Turning the knob in the direction of the “ON” position turns on the front fog lights as well as the indicator in the instrument cluster. To turn them off, turn the knob in the direction of the “OFF” position.

The knob will return to the neutral position when it is released.

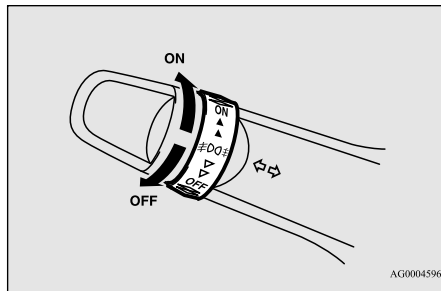

NOTE

- If the headlights are switched to high beam, the front fog lights will go out; they will illuminate again when the headlights are switched back to low beam.
- If the light switch is rotated to the “OFF” or “OFF” position while the front fog lights are illuminated, they will automatically turn off. They can be turned back on again by rotating the combination headlights and dimmer switch back to “ON” position, and turning the knob in the direction of the “ON” position.
- Do not use fog lights except in conditions of fog, otherwise excessive light glare may temporarily blind oncoming vehicle drivers.

Wiper and washer switch

N00523001764

CAUTION

- If the washer is used in cold weather, the washer fluid sprayed against the glass may freeze, which may hinder visibility. Warm the glass with the defroster before using the washer.

Windshield wipers

NOTE

- To ensure a clear rearward view, the rear window wiper will automatically perform several continuous operations if the gearshift lever or the selector lever is put in the “R” position while the windshield wipers are operating. Refer to “Rear window wiper and washer” on page 5-154.

Except for vehicle with rain sensor

The windshield wiper and washer can be operated with the ignition switch or the operation mode is in ON or ACC.

If the blades are frozen to the windshield, do not operate the wipers until the ice has melted and the blades are freed, otherwise the wiper motor may be damaged.

Wiper and washer switch

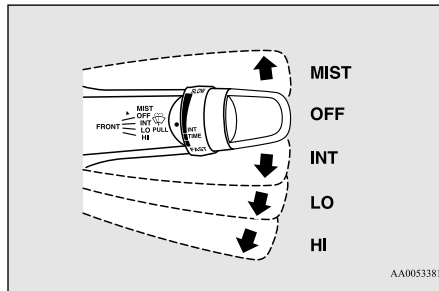

- MIST- Misting function
The wipers will operate once.
- OFF- Off
- INT- Intermittent (Speed sensitive)
- LO- Slow
- HI- Fast

To adjust intermittent intervals

With the lever in the “INT” (speed sensitive intermittent operation) position, the intermittent intervals can be adjusted by turning the knob (A).

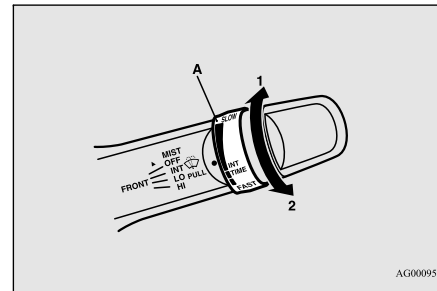

- 1- Fast
- 2- Slow

NOTE

- The speed-sensitive-operation function of the windshield wipers can be deactivated. For further information, please contact your authorized Mitsubishi Motors dealer or a repair facility of your choice.

Misting function

The misting function can be used when the ignition switch or the operation mode is in ON or ACC.

The wipers will operate once if the wiper lever is raised to the “MIST” position and released. This operation is useful when it is drizzling, etc. The wipers will continue to operate while the lever is held in the “MIST” position.

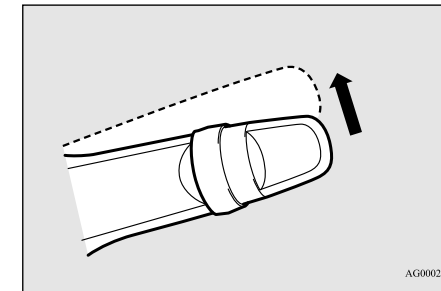

5

Vehicle with rain sensor

The windshield wipers can be operated with the ignition switch or the operation mode is in ON or ACC.

If the blades are frozen to the windshield or rear window, do not operate the wipers until the ice has melted and the blades are freed, otherwise the wiper motor may be damaged.

Wiper and washer switch

5

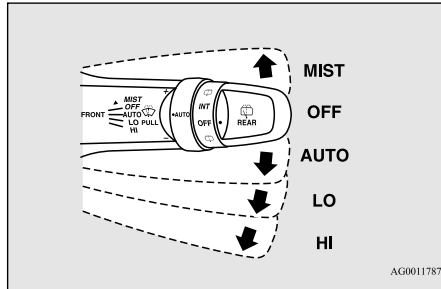

- MIST-** Misting function
The wipers will operate once.
- OFF-** Off
- INT-** Auto-wiper control
Rain sensor
The wipers will automatically operate depending on the degree of wetness on the windshield.
- LO-** Slow
- HI-** Fast

Rain sensor (if so equipped)

Can only be used when the ignition switch or the operation mode is in ON.
If the lever is put in the “AUTO” position, the rain sensor (A) will detect the extent of rain (or snow, other moisture, dust, etc.) and the wipers will operate automatically.
Keep the lever in the “OFF” position if the windshield is dirty and the weather is dry.

Wiper operation under these conditions can scratch the windshield and damage the wipers.

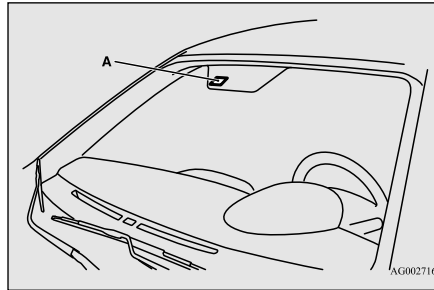

CAUTION

- With the ignition switch or the operation mode in ON and the lever in the “AUTO” position, the wipers may automatically operate in the situations described below.
 - When cleaning the outside surface of the windshield, if you touch the rain sensor.
 - When cleaning the outside surface of the windshield, if you wipe with a cloth the rain sensor.
 - When using an automatic car wash.
 - A physical shock is applied to the windshield.
 - A physical shock is applied to the rain sensor.

CAUTION

If your hands get trapped, you could suffer injuries or the wipers could malfunction. Be sure to turn the ignition switch to the “OFF” position or put the operation mode in OFF, or move the lever to the “OFF” position to deactivate the rain sensor.

NOTE

- To protect the rubber parts of the wipers, this operation of the wipers does not take place when the vehicle is stationary and the ambient temperature is about 32 °F (0 °C) or lower, even if the lever is put in the “AUTO” position.
- Do not cover the sensor by affixing a sticker or label to the windshield. Also, do not put any water-repellent coating on the windshield. The rain sensor would not be able to detect the extent of rain, and the wipers might stop working normally.
- In the following cases, the rain sensor may be malfunctioning. Have the vehicle checked at an authorized Mitsubishi Motors dealer or a repair facility of your choice.
 - When the wipers operate at a constant interval despite changes in the extent of rain.
 - When the wipers do not operate even though it is raining.

Wiper and washer switch

NOTE

- The wipers may automatically operate when things such as insects or foreign objects are affixed to the windshield on top of the rain sensor or when the windshield is frozen. Objects affixed to the windshield will stop the wipers when the wipers cannot remove them. To operate the wipers again, move the lever to the “LO” or “HI” position. Also, the wipers may operate automatically due to strong direct sunlight or electromagnetic wave. To stop the wipers, move the lever to the “OFF” position.
- Contact an authorized Mitsubishi Motors dealer or a repair facility of your choice when replacing the windshield glass.

To adjust the sensitivity of the rain sensor

With the lever in the “AUTO” (rain sensor) position, it is possible to adjust the sensitivity of the rain sensor by turning the knob (B).

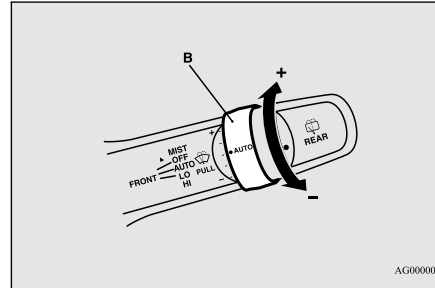

- “+”- Higher sensitivity to rain
- “-”- Lower sensitivity to rain

NOTE

- Automatic wiper operation (rain sensitive) can be changed to intermittent operation, either vehicle speed sensitive or not vehicle speed sensitive. For further information, please contact your authorized Mitsubishi Motors dealer or a repair facility of your choice.

Misting function

Move the lever in the direction of the arrow and release, to operate the wipers once. Use this function when you are driving in mist or drizzle. The wipers will operate once if the lever is raised to the “MIST” position and released when the ignition switch or the operation mode is in ON or ACC. The wipers will con-

tinue to operate while the lever is held in the “MIST” position.

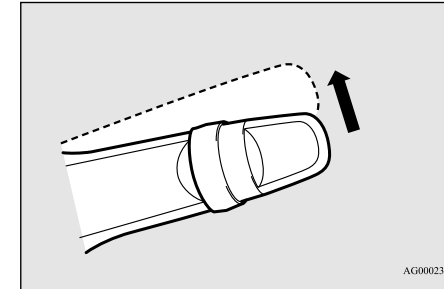

5

The wipers will operate once if the lever is moved to the “AUTO” position and the knob (C) is turned in the “+” direction when the ignition switch or the operation mode is in ON.

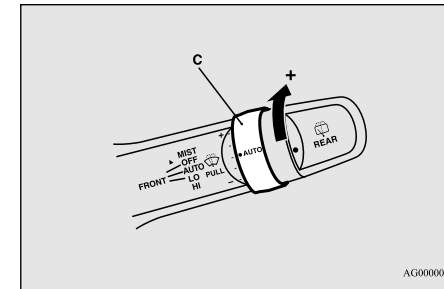

Wiper and washer switch

Windshield washer

N00504601383

The windshield washer can be operated with the ignition switch or the operation mode is in ON or ACC.

The washer fluid will be sprayed onto the windshield by pulling the lever toward you.

5

When the wipers are not in operation or in intermittent operation, by pulling the lever toward you, the wipers will operate several times while the washer fluid is being sprayed.

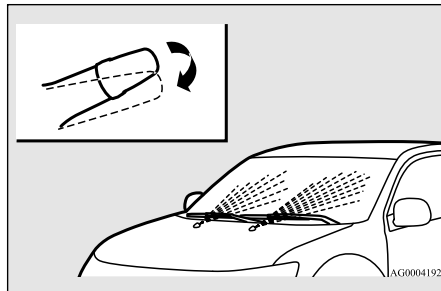

AG0004192

NOTE

- It is possible to modify functions as follows:
 - Intelligent washer can be activated. Refer to "Intelligent washer" on page 5-154.
 - The wipers can be set to operate again after about 6 seconds.

NOTE

These functions are not activated when the vehicle is shipped from the factory. To activate or deactivate these functions, please contact your authorized Mitsubishi Motors dealer.

Intelligent washer

By releasing the lever soon after pulling it toward you, the washer fluid will be sprayed several times while the wipers are operating several times.

Intelligent washer will stop operating with any operation of the lever.

Rear window wiper and washer

N00523201421

The rear window wiper and washer can be operated when the ignition switch or the operation mode is in ON or ACC.

Turn the knob to operate the rear window wiper.

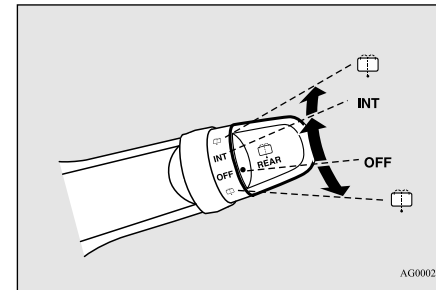

AG0002345

OFF- Off

INT- The wiper operates continuously for several seconds then operates intermittently at intervals of about 8 seconds.

 Washer fluid will be sprayed onto the rear window glass while the knob is turned fully in either direction. When the washer fluid is sprayed, the wiper will automatically operate 2 or 3 times.

NOTE

- The rear window wiper will automatically perform several continuous operations if the gearshift lever or the selector lever is put in the “R” position while the windshield wipers or the rear window wiper is operating (automatic operation mode)

After the automatic operation, the rear window wiper will stop operating if the knob is in the “OFF” position. If the knob is in the “INT” position, the rear window wiper will return to the intermittent operation.

It is possible to set the rear window wiper to perform the automatic operation only if the gearshift lever or the selector lever is put in the “R” position while the rear window wiper is operating with the knob in the “INT” position.

See your authorized Mitsubishi Motors dealer for details.

- If the knob is in the “OFF” position, turn the knob to the “INT” position twice quickly to operate the rear window wiper continuously (continuous operation mode)

Turn the knob to the “OFF” position to stop the rear window wiper continuous operation.

- The wiper intermittent operation time can be adjusted.

See your authorized Mitsubishi Motors dealer for details.

NOTE

- The washer fluid reservoir is located in the engine compartment. Check the fluid level regularly and refill if necessary. (Refer to “Washer fluid” on page 9-10.)

Precautions to observe when using wipers and washers

N00523501307

CAUTION

- If the washer is used in cold weather, the washer fluid sprayed onto the glass might freeze, blocking your view. Heat the glass with the defroster before using the washer.

NOTE

- Do not use the wipers when the windshield is dry. This could scratch the glass and wear the wiper blades prematurely.
- Before using the wipers in cold weather, check to be sure that the wiper blades are not frozen to the windshield or rear window. Using the wipers while the blades are frozen could cause the wiper motor to burn out.

Electric rear window defogger switch**NOTE**

- If the moving wipers become blocked part-way through a sweep by ice or other deposits on the glass, the wipers may temporarily stop operating to prevent the motor from overheating. In this case, park the vehicle in a safe place, turn the ignition switch to the “OFF” position or put the operation mode in OFF, and then remove the ice or other deposits.

Because the wipers will start operating again after the wiper motor cools down, check that the wipers operate before using them.

- Avoid using the washer for more than 20 seconds at a time. Do not operate the washer when the washer fluid reservoir is empty or the pump may fail.

- During cold weather, add a recommended washer solution that will not freeze in the washer fluid reservoir. Otherwise the washer may not work or may be damaged.

- Replace the wiper blades when they are worn. Use the proper size replacement blades. For further information, please contact your authorized Mitsubishi Motors dealer.

Electric rear window defogger switch

N00523700373

The rear window defogger can be used when the engine is running.

Horn switch

The indicator light (A) will come on when you press the electric rear window defogger switch. Electric current will flow through the heating wires on the rear window to help clear away moisture or frost.

5

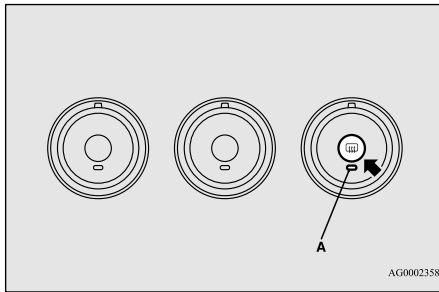

After about 20 minutes of operation, the system will shut off automatically. To switch the defogger OFF before 20 minutes have passed, press the switch again. The indicator light will go out and the defogger will turn off. If you need the defogger for more than 20 minutes, press the switch again. This will add 20 more minutes.

CAUTION

- The rear window defogger is not designed to melt snow. Remove any snow manually before using the rear window defogger.

5-156 Features and controls

CAUTION

- Use the rear window defogger only after the engine has started and is running. Be sure to turn the defogger switch off immediately after the window is clear to save on battery power.
- Do not place stickers, tape, or other items that are attached with adhesive over the grid wires on the rear window.
- When cleaning the inside rear window, use a soft cloth and wipe lightly over the grid wires.

NOTE

- As your vehicle is equipped with heated mirrors, mist can also be removed from the outside rearview mirrors when the rear window defogger switch is pressed. (Refer to “Door mirror heater” on page 5-46.)

Horn switch

N00523801209

To honk the horn, press around the “” mark on the steering wheel.

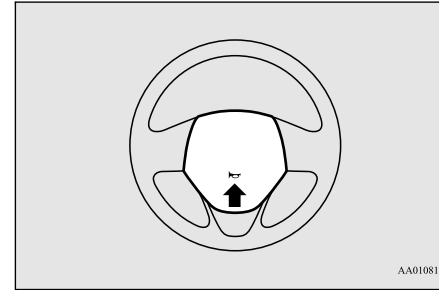

Link System (if so equipped)

N00563701200

The Link System takes overall control of the devices connected via the USB input terminal allowing the connected devices to be operated by using the switches in the vehicle. Refer to “USB input terminal” on page 5-156.

USB input terminal (if so equipped)

N00566701197

You can connect your USB memory device or iPod* to play music files stored in the USB memory device or iPod.

*: “iPod” is a registered trademark of Apple Inc. in the United States and other countries.

How to connect a USB memory device

N00566801198

1. Park your vehicle in a safe place and turn the ignition switch to the "OFF" position or put the operation mode in OFF.
2. Connect a commercially available USB connector cable (B) to the USB memory device (A).

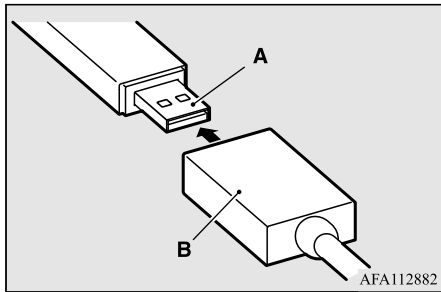

AFA112882

3. Connect the USB connector cable (B) to the USB input terminal (C).

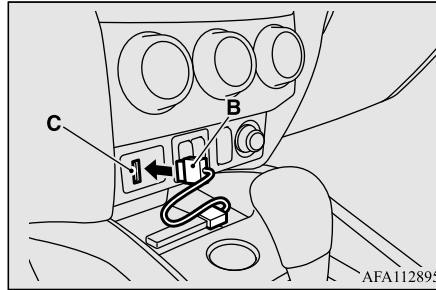

AFA112895

NOTE

- Do not connect the USB memory device to the USB input terminal directly. The USB memory device may be damaged.

4. To remove the USB connector cable, turn the ignition switch to the "OFF" position or put the operation mode in OFF first and perform the installation steps in reverse.

How to connect an iPod

N00566901229

1. Park your vehicle in a safe place and turn the ignition switch to the "OFF" position or put the operation mode in OFF.
2. Connect the connector cable to the iPod.

USB input terminal (if so equipped)

NOTE

- Use a genuine connector cable from Apple Inc.

3. Connect the connector cable (A) to the USB input terminal (B).

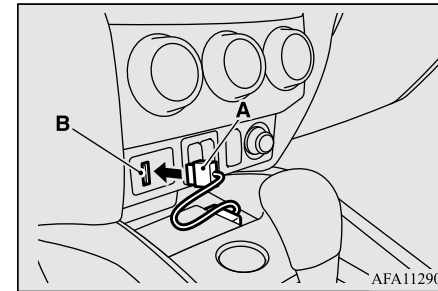

AFA112909

4. To remove the connector cable, turn the ignition switch to the "OFF" position or put the operation mode in OFF first and perform the installation steps in reverse.

5

Types of connectable devices and supported file specifications

N00567001113

On vehicles equipped with the Smartphone Link Display Audio or the DISPLAY AUDIO, refer to the separate owner's manual

Sun visors

for details about the types of connectable devices and supported file specifications.

Sun visors

N00524601392

5

Pull the sun visor downward (1) to reduce front glare while driving. To reduce side glare, turn the visor to the side (2).

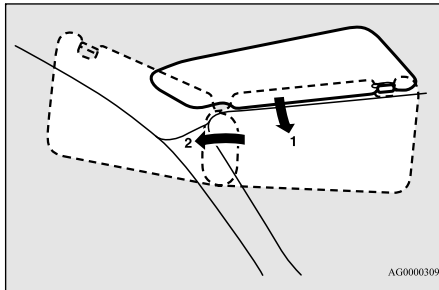

Vanity mirror

Type 1

A vanity mirror is fitted to the back of the sun visor.

Operating the lid of the vanity mirror will automatically turn on the mirror light (A).

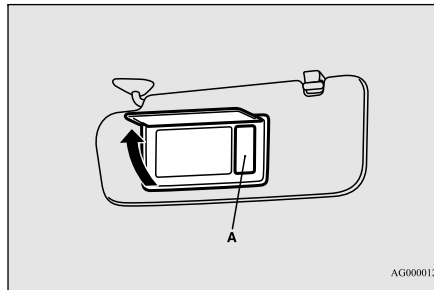

CAUTION

- If the lid of vanity mirror with light is kept open for prolonged periods of time, the vehicle's battery will be discharged.

Type 2

A vanity mirror is fitted to the back of the sun visor.

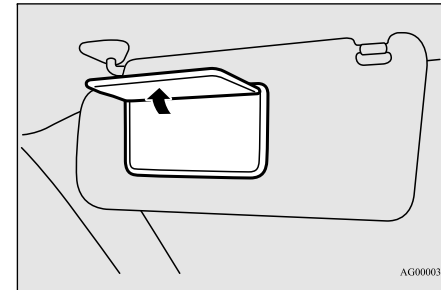

Card holder

Cards can be slipped into the holder (B) on the sun visor.

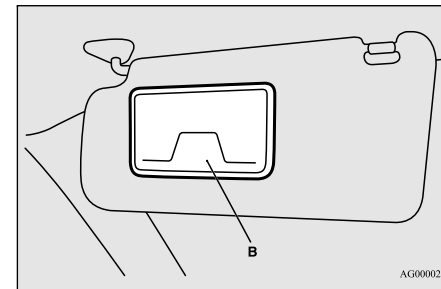

12 V power outlets

N00525001713

⚠ CAUTION

- Be sure to use a “plug-in” type accessory operating at 12 V and at 120 W or less. When using more than one socket at the same time, make sure the total power consumption of the electrical accessories does not exceed 120 W at 12 V.
- Also be aware that using electronic equipment with the engine off may run the battery down.
- When the power outlet is not in use, be sure to close the power outlet cover or replace the cap. This will prevent the power outlet from becoming clogged and short circuiting.

To use a “plug-in” type accessory, open the cover or remove the cap, and insert the plug in the power outlet.

📖 NOTE

- If your vehicle is equipped with two 12V power outlets, they can be used simultaneously.

Type 1

Accessories can be operated while the ignition switch or the operation mode is in ON or ACC.

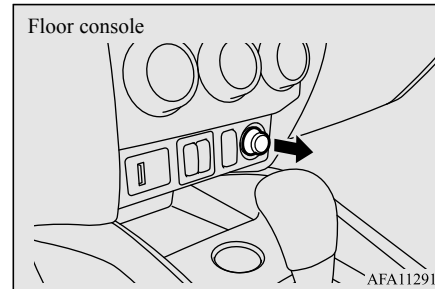

⚠ WARNING

- The hole next to the power outlet in the floor console is not a cup holder. This hole can be used as a personal compartment, but should never be used as a cup holder. Spilling beverages onto the power outlet could cause a short-circuit or an electric shock.

Type 2

Accessories can be operated in all ignition switch positions or all operation modes.

12 V power outlets

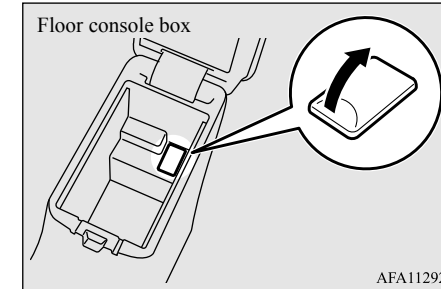

5

HomeLink® Wireless Control System (if so equipped)

N00554301053

HomeLink® Wireless Control System is a registered trademark of Gentex Corporation.

HomeLink® provides a convenient way to replace up to 3 hand-held radio-frequency (RF) transmitters used to activate devices such as gate operators, garage door openers, entry door locks, security systems, even home lighting. Additional HomeLink® information can be found at www.homelink.com, www.youtube.com/HomeLinkGentex, or by calling the toll-free HomeLink®-Hotline at 1-800-355-3515.

HomeLink® Wireless Control System (if so equipped)

5

⚠ WARNING

- Do not use HomeLink® with any garage door opener that lacks safety stop and reverse features as required by U.S. Federal Regulations. A garage door opener which cannot detect an object in the path of a closing garage door and then automatically stop and reverse, does not meet current U.S. Federal Regulations. Using a garage door opener without these features increases the risk of serious injury or death.
- During programming, your garage door or gate may open or close. Make sure that people and objects are clear of the garage door or gate that you are programming.

📖 NOTE

- Once HomeLink® is programmed, retain the original transmitter for future programming procedures (for example, new vehicle purchases). Upon sale of the vehicle, the programmed HomeLink® buttons should be erased for security purposes. Refer to “Cleaning the programmed information” on page 5-164.

📖 NOTE

- You can program a maximum of 3 devices. To change or replace any of the 3 devices after it has been initially programmed, you must first erase the current settings. See “Cleaning the programmed information” on page 5-164 or “Reprogramming a single HomeLink® button” on page 5-164.

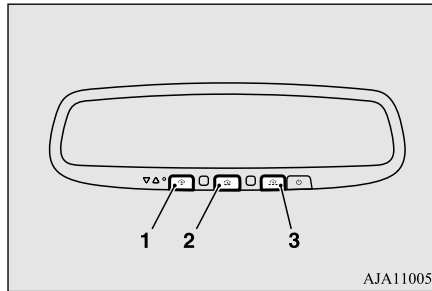

- 1- HomeLink® button 1
- 2- HomeLink® button 2
- 3- HomeLink® button 3

Before programming Home-Link®

N0058460032

- Some garage door openers manufactured after 1995 have “rolling code protection”. To program a garage door opener equipped with “rolling code protection”, you will need to access the garage door opener motor to press the motor’s “Learn” or “Smart” buttons. For convenience, use a ladder and another person to assist you.
- It is recommended that a new battery be placed in the hand-held transmitter of the device being programmed to HomeLink® for quicker training and accurate transmission of the radio-frequency signal.

Programming a new Home-Link®

N0058470033

To program HomeLink® to operate a garage door, gate, or entry door opener, home or office lighting, you need to be at the same location as the device.

1. Press the HomeLink® button that you would like to program. The indicator light (A) will flash orange slowly.

HomeLink® Wireless Control System (if so equipped)

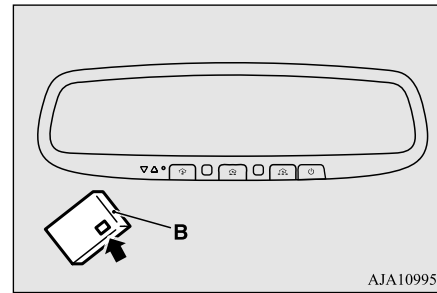
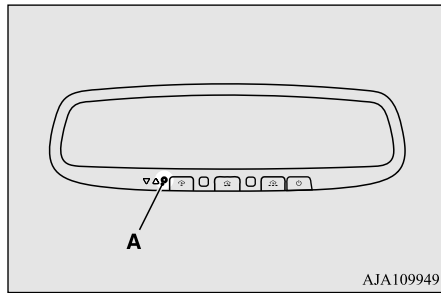

NOTE

- You do not need to continue holding the HomeLink® button.
- If the indicator light does not flash, refer to “Cleaning the programmed information” on page 5-164.

2. Position the end of your hand-held transmitter (B) 1 to 3 inches (2 to 8 cm) away from the HomeLink® button while keeping the indicator light in view.

NOTE

- Some hand-held transmitters may actually train better from a distance of 6 to 12 inches (15 to 20 cm). Keep this in mind if you have difficulty with the programming process.

3. Press and hold the hand-held transmitter button while watching the indicator light (A). Continue pressing the button until the indicator light (A) changes from slowly flashing orange to either rapidly flashing green (rolling code) or continuously lit green (fixed code). Now you may release the hand-held transmitter button.

NOTE

- Some devices may require you to replace this “Programming a new HomeLink®” step 3 with procedures noted in the “Gate operator / Canadian programming” section. If the indicator light does not change to rapidly flashing green or continuously lit green after performing these steps, contact HomeLink® at www.homelink.com

5

4. Press the HomeLink® button that was just programmed and observe the indicator light.

- If the indicator light continuously illuminates green, programming is complete and your device should operate when the HomeLink® button is pressed and released.
- If the indicator light rapidly flashes green, firmly press, hold for 2 seconds and release the programmed HomeLink® button. Repeat the “press/hold/release” sequence a second time, and, depending on the brand of the garage door opener (or other rolling code equipped device), repeat this sequence a third time to complete the programming process. At this point if your device operates, programming is complete.

HomeLink® Wireless Control System (if so equipped)

5

- If the device does not operate, continue with “Programming a new HomeLink®” steps 5 to 7 to complete the programming of a rolling code equipped device.
5. At the garage door opener receiver (motor-head unit) in the garage, locate the “Learn” or “Smart” button. This can usually be found where the hanging antenna wire is attached to the motor-head unit (see the garage door opener manual to identify the “Learn” button.)
 6. Firmly press and release the “Learn” or “Smart” button. (The name and color of the button may vary by manufacturer.) There are typically 30 seconds to initiate step 7.
 7. Return to the vehicle and firmly press, hold for 2 seconds and release the programmed HomeLink® button. Repeat the “press/hold/release” sequence a second time, and, depending on the brand of the garage door opener (or other rolling code equipped device), repeat this sequence a third time to complete the programming process.
- HomeLink® should now activate your rolling code equipped device.

NOTE

- In the event that there are still programming difficulties or questions, additional HomeLink® information and programming videos can be found online at www.homelink.com, www.youtube.com/HomeLinkGentex, or by calling the HomeLink® Hotline.

Gate operator/Canadian programming

N00584800034

Canadian radio-frequency laws require transmitter signals to “time-out” (or quit) after several seconds of transmission - which may not be long enough for HomeLink® to pick up the signal during programming. Similar to this Canadian law, some U.S. gate operators are designed to “time-out” in the same manner.

The indicator LED on the hand-held transmitter will go off when the device times out indicating that it has finished transmitting. If you live in Canada or you are having difficulties programming a gate operator or garage door opener by using the “Programming” procedures, replace “Programming a new HomeLink®” step 3 with the following:

NOTE

- If programming a garage door opener or gate operator, it is advised to unplug the device during the “cycling” process to prevent possible overheating.

3. Press and release - every 2 seconds (“cycle”) your hand-held transmitter until the HomeLink® indicator light changes from slowly flashing orange to either rapidly flashing green (rolling code) or continuously lit green (fixed code). Now you may release the hand-held transmitter button.

Proceed with “Programming a new HomeLink®” step 4 to complete.

Additional steps for programming a door system with feedback

N00584900035

The HomeLink® has the capability of receiving garage door status from compatible garage door opener systems. Check your garage door opener manual for the available feature and HomeLink® compatibility. Also for a listing of compatible systems contact HomeLink® at: www.homelink.com

HomeLink® Wireless Control System (if so equipped)

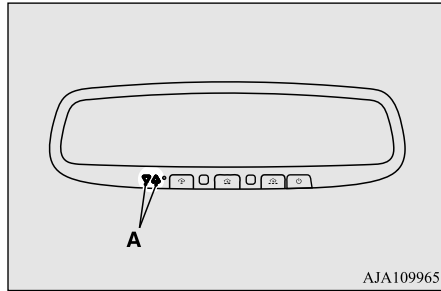

1. Within 5 seconds after successfully programming the garage door opener (refer to “Programming a new HomeLink®” section), both garage door operation indicators (A) will flash rapidly green indicating that the garage door feedback has been enabled.

If the indicators do not flash, perform steps 2 and 3 while pressing the HomeLink® button up to the first 10 times after successful programming.

2. Press and release the programmed HomeLink® button to activate the door. You now have 1 minute in which to complete step 3.

3. Once the door has stopped, press and release the “Learn” or “Smart” button on the garage door opener (refer to your garage door opener owner’s manual for the location of the “Learn” button). Both the HomeLink® garage door operation indicators will flash rapidly green upon successful synchronization with the door opener (within 5 seconds).

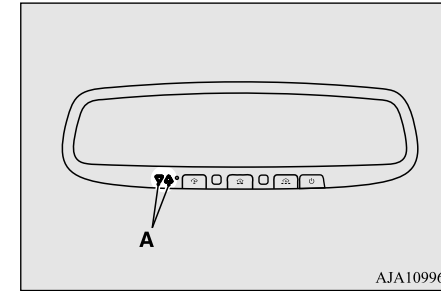

5

Operating HomeLink®

N0058500035

To operate, simply press and release the programmed HomeLink® button. Activation will now occur for the trained device (i.e. garage door opener, gate operator, security system, entry door lock, home/office lighting, etc.). For convenience, the hand-held transmitter of the device may also be used at any time.

Garage door feedback

N0058520035

The HomeLink® has the capability of receiving garage door status from compatible garage door opener systems. Refer to “Additional steps for programming a door system with feedback” on page 5-162.

Garage door status is then displayed with indicators (A).

The indicators will illuminate/blink in response to the following conditions:

▼▲: Blinking ▼ ▲: Illuminates

Garage door opener closing	▼▲ (orange)
Garage door opener closed	▼ (green)
Out of range	▼▲ (red)
Garage door opener opening	▲ (orange)
Garage door opener opened	▲ (green)
Out of range	▼▲ (red)

HomeLink® Wireless Control System (if so equipped)

5

The HomeLink® has the capability of listening to these messages at a range up to 820.2 feet (250 m) (open line of sight), but range may be reduced by obstacles such as houses or trees. You may have to slow your vehicle speed to receive the CLOSED or OPENED message feedback from the garage door opener. If the unit is out of range before receiving either the UP or DOWN message from the door opener, both the UP and DOWN indicators will flash red followed by a continuous lit orange indicator in the direction the door was last moving.

Recall of the door state after initial feedback is possible by simultaneously pressing either HomeLink® buttons 1 and 2 or buttons 2 and 3 for 2 seconds. The last recorded message will be displayed for 3 seconds, again following the garage door status indication of the figure above.

Clearing the programmed information

N00585300036

To erase programming from the 3 buttons (individual buttons cannot be erased but can be “reprogrammed” as outlined below), follow the steps noted:

1. Press and hold the 2 outer HomeLink® buttons for at least 10 seconds. The indicator will change from continuous yellow to rapidly flashing green.
2. Release both buttons.

NOTE

- Do not hold for longer than 20 seconds.

3. HomeLink® is now in the train (or learning) mode and can be programmed at any time beginning with “Programming a new HomeLink®” step 1.

Reprogramming a single HomeLink® button

N00585400037

To reprogram a HomeLink® button, complete the following.

1. Press and hold the desired HomeLink® button. Do not release the button.
2. The indicator light will begin to slowly flash orange after 20 seconds. The HomeLink® button can be released at this point. Proceed with “Programming a new HomeLink®” step 2.

NOTE

- If you do not complete the programming of a new device to the button, it will revert to the previously stored programming. For questions or comments, visit www.homelink.com, www.youtube.com/HomeLinkGentex, or by calling the HomeLink® Hotline.

General information

N00585600039

Your HomeLink® system operates on a radio frequency subject to Federal Communications Commission (FCC) Rules (For vehicles sold in U.S.A.) and Industry Canada Rules (For vehicles sold in Canada). This device complies with Part 15 of the FCC Rules and RSS- 210 of the Industry Canada Rules. Operation is subject to the following two conditions.

- This device may not cause harmful interference.
- This device must accept any interference that may be received, including interference that may cause undesired operation.

Interior lights

⚠ CAUTION

- The transmitter has been tested and complies with FCC and IC rules. Changes or modifications not expressly approved by the party responsible for compliance could void the user's authority to operate the device.

This equipment complies with FCC radiation exposure limits set forth for an uncontrolled environment. End Users must follow the specific operating instructions for satisfying RF exposure compliance. This transmitter must be at least 12 inches (20 cm) from the user and must not be co-located or operating in conjunction with any other antenna or transmitter.

The term "IC:" before the certification/registration number only signifies that Industry Canada technical specifications were met.

Interior lights

N00525300562

📖 NOTE

- Be aware that leaving the light illuminated with the engine off may run the battery down. Never leave the vehicle without checking that the light is off.

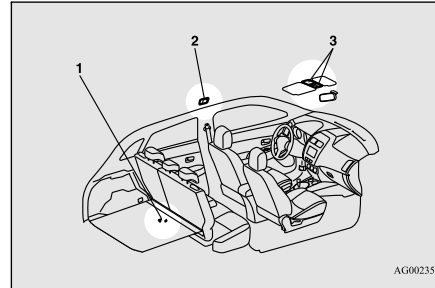

- 1- Cargo room light → P.5-167
 - 2- Dome light (Rear) (if so equipped) → P.5-166
 - 3- Dome light (Front)/Reading lights → P.5-165
- Sunshade illumination dimming control switch (if so equipped) → P.5-167

Dome light (front)/Reading lights

N00525401472

Dome light (front)

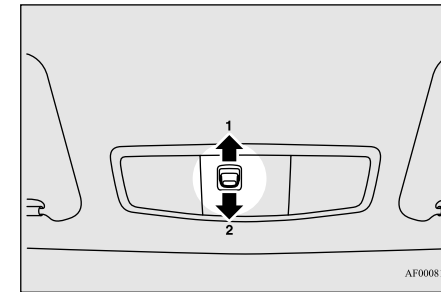

5

1- (DOOR)

The light illuminates when a door or the liftgate is opened. It goes off approximately 30 seconds after the door or liftgate is closed.

However, the light goes off immediately in the following cases:

- When the ignition switch is turned to the "ON" position or the operation mode is put in ON.
- When the power door lock function is used to lock the vehicle.

Interior lights

- When the remote control transmitter of the keyless entry system or the F.A.S.T.-key is used to lock the vehicle.
- If the vehicle is equipped with the F.A.S.T.-key, when the F.A.S.T.-key is used to lock the vehicle.

5

NOTE

- When the doors other than the driver's door and liftgate are closed if the driver's door is closed while its lock knob is in the lock position, the light goes off immediately.
- When the key was used to start the engine, if the key is removed while the doors and liftgate are closed, the light is illuminated and after approximately 30 seconds it goes off.
- When the F.A.S.T.-key was used to start the engine, if the operation mode is put in OFF while the doors and liftgate are closed, the light illuminates and after approximately 30 seconds it goes off.
- The time until the light goes off can be adjusted. See your authorized Mitsubishi Motors dealer for details.

- 2-
- The light goes off regardless of whether a door or the liftgate is open or closed.

Reading lights

N00537600155

Regardless of the position of the dome light switch, when the lens is pressed, the light on the side that was pressed will illuminate. Press the lens again to turn off the light.

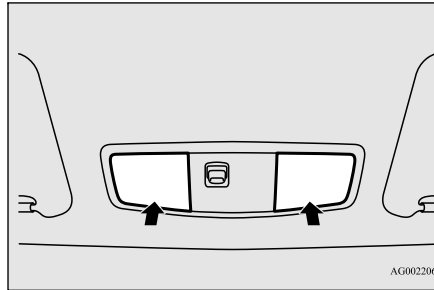

Dome light (rear) (if so equipped)

N00525801258

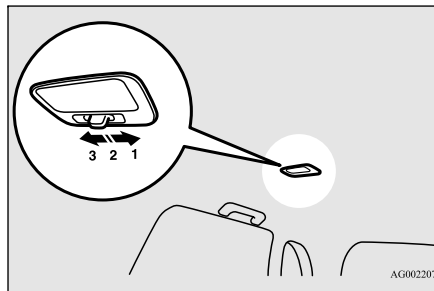

1- (☺)

The light illuminates regardless of whether a door or the liftgate is open or closed.

2- (●)

The light illuminates when a door or the liftgate is opened. It goes off approximately 30 seconds after the door or liftgate is closed.

However, the light goes off immediately in the following cases:

- When the ignition switch is turned to the "ON" position or the operation mode is put in ON.
- When the power door lock function is used to lock the vehicle.
- When the remote control transmitter of the keyless entry system or the F.A.S.T.-key is used to lock the vehicle.
- If the vehicle is equipped with the F.A.S.T.-key, when the F.A.S.T.-key is used to lock the vehicle.

NOTE

- When the doors other than the driver's door and liftgate are closed if the driver's door is closed while its lock knob is in the lock position, the light goes off immediately.
- When the key was used to start the engine, if the key is removed while the doors and liftgate are closed, the light is illuminated and after approximately 30 seconds it goes off.

Interior lights

NOTE

- When the F.A.S.T.-key was used to start the engine, if the operation mode is put in OFF while the doors and liftgate are closed, the light illuminates and after approximately 30 seconds it goes off.
- The time until the light goes off can be adjusted. See your authorized Mitsubishi Motors dealer for details.

3- (○)

The light goes off regardless of whether a door or the liftgate is open or closed.

Cargo room light

N00526100163

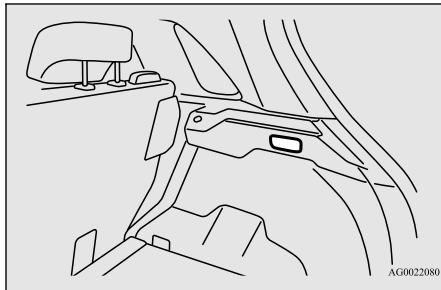

The light illuminates when the liftgate is opened, and goes out when the liftgate is closed.

Sunshade illumination dimming control switch (if so equipped)

N00568500020

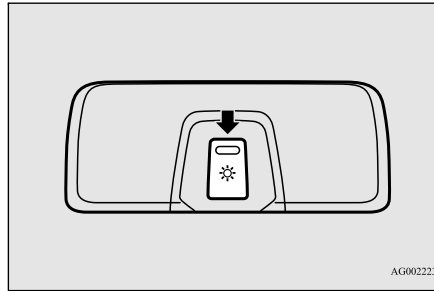

The brightness of the sunshade illumination can be adjusted to 3 different levels when the ignition switch or the operation mode is in ON or ACC.

Each time you press the switch, the brightness switches in sequence from high → middle → low → off → high.

NOTE

- The brightness can be adjusted even when the ignition switch is in the "OFF" position or the operation mode is in OFF, provided that the sunshade illumination is turned on.

Sunshade illumination (if so equipped)

N00568601031

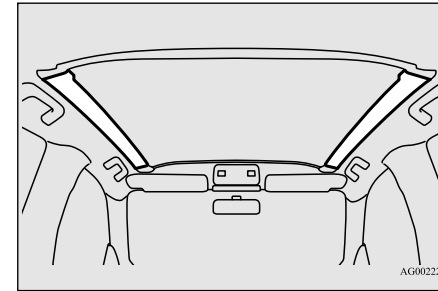

The sunshade illumination turns on when the ignition switch or the operation mode is in ON or ACC.

NOTE

- The sunshade illumination does not turn on if the sunshade illumination dimming control switch is off. Refer to "Sunshade illumination dimming control switch" on page 5-167.

When the sunshade illumination is turned on, it will go off approximately 30 seconds after the following operation is performed.

Storage spaces

- When the key was used to start the engine, the key is removed while all doors and the liftgate remain closed.
- For vehicles equipped with the F.A.S.T.-key, the operation mode is put in OFF while the engine is running and the doors and the liftgate are closed.

5

NOTE

- The time until the sunshade illumination goes off can be adjusted. If it is adjusted, the time until the dome light go off is also adjusted automatically at the same time. See your authorized Mitsubishi Motors dealer for details.

The sunshade illumination also turns on when a door or the liftgate is opened, and goes off 30 seconds after the door or the liftgate is closed, even when the engine switch is in the “OFF” position or the operation mode is in OFF.

However, the sunshade illumination immediately goes off in the following cases.

- When the power door lock function is used to lock the vehicle.
- When the remote control transmitter of the keyless entry system or the F.A.S.T.-key is used to lock the vehicle.

- If the vehicle is equipped with the F.A.S.T.-key, when the F.A.S.T.-key is used to lock the vehicle.

NOTE

- When the doors other than the driver’s door and liftgate are closed if the driver’s door is closed while its lock knob is in the lock position, the light goes off immediately.
- The sunshade illumination does not turn on if the sunshade illumination dimming control switch is off.
- The time until the sunshade illumination goes off can be adjusted. If it is adjusted, the time until the dome light go off is also adjusted automatically at the same time. See your authorized Mitsubishi Motors dealer for details.

Interior light auto-cutout function (dome light and other lights)

N00526301452

- If any of the interior lights are left switched on with the ignition switch is in the “OFF” position or the operation mode is in OFF, it goes off automatically after approximately 30 minutes.

- The lights will illuminate again after they automatically go off if the ignition switch or the engine switch is operated, or if the keyless entry system or the F.A.S.T.-key is operated.

NOTE

- The interior light auto-cutout function can be deactivated.
The time until the lights automatically go off can be adjusted. See your authorized Mitsubishi Motors dealer for details.

Storage spaces

N00526400469

CAUTION

- Never leave lighters, carbonated drink cans, or spectacles in the cabin when parking the vehicle in hot sunshine. The cabin will become extremely hot, so lighters and other flammable items may catch fire and unopened drink cans (including beer cans) may rupture. The heat may also deform or crack plastic spectacle lenses and other spectacle parts that are made of plastic.
- Keep the lids of storage spaces closed while driving the vehicle. A lid or the contents of a storage space could otherwise cause injuries during a sudden stop.

Storage spaces

NOTE

- Do not leave valuables in any storage space when leaving the vehicle.

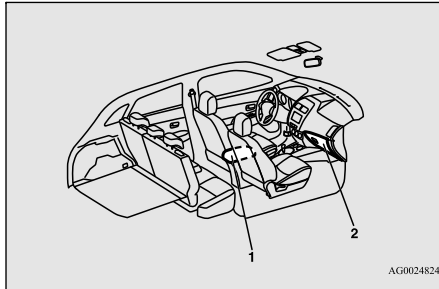

- 1- Floor console box
- 2- Glove compartment

Glove compartment

N00551500204



WARNING

- An open glove compartment door can cause a serious injury or death to the front passenger in an accident, even if the passenger is wearing his/her seat belt. Always keep the glove compartment door closed when driving.

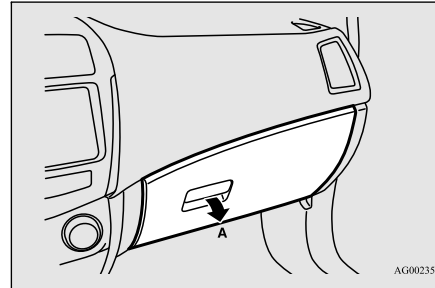
To open, pull the lever (A).



NOTE

- When the lights are illuminated with the light switch in the “”, “”, or “AUTO” position (vehicles with automatic light control), the glove compartment light illuminates.

Pen holder

There is a pen holder inside the glove compartment.

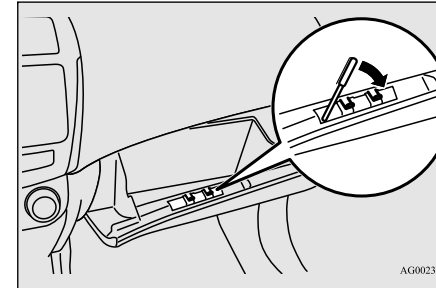

NOTE

- There is a limit to the size of pens that can be stored in the holder. Forcing large pens into the holder could cause damage.

Card holder

There is a card holder inside the glove compartment.

Cup holders

5

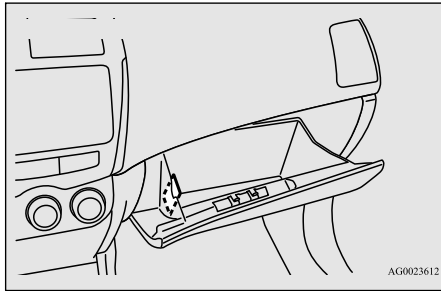

NOTE

- The floor console box can also be used as an arm rest.

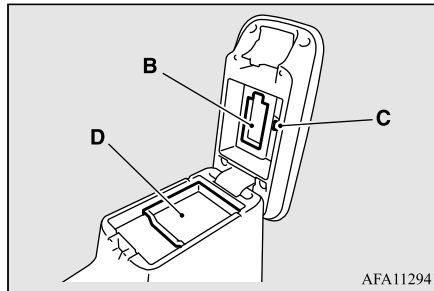

- B- Tissue holder
- C- Pen holder
- D- Tray

WARNING

- Do not spray water or spill beverages inside the vehicle. If the switches, wires, or electrical components become wet, they could malfunction or cause a vehicle fire. If you accidentally spill a beverage, wipe up as much liquid as possible.

Floor console box

N00551601316

To open the console box, lift the release lever (A) and raise the lid.

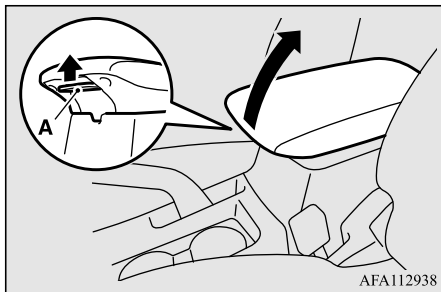

A pocket-sized tissue pack and a pen can be stored on the underside of the floor console box lid.

Cup holders

N00527301547

The cup holder is designed for holding cups or drink-cans securely in its holes.

For the front seat

The cup holder is located in front of the floor console.

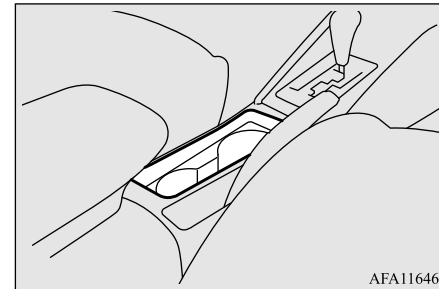

For the rear seat (if so equipped)

N00537001198

In order to use the cup holder, allow the arm rest (A) to drop down.

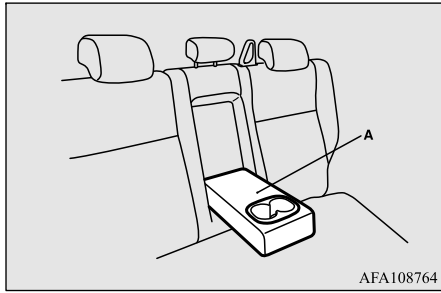

AFA108764

There are bottle holders located on the front doors.

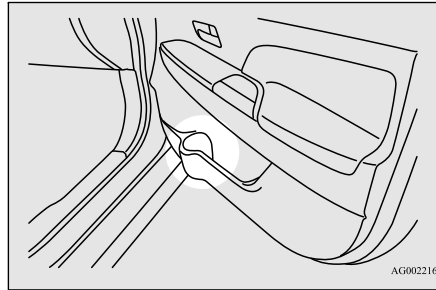

AG0022165

Bottle holder

N00502801088

⚠ WARNING

- Do not spray water or spill beverages inside the vehicle. If the switches, wires, or electrical components become wet, they could malfunction or cause a vehicle fire. If you accidentally spill a beverage, wipe up as much liquid as possible.

⚠ CAUTION

- Drink beverages while driving your vehicle is distracting and can cause an accident.
- Vibration and shaking while driving may cause beverages to spill. Be very careful, as spilling hot beverages could cause burns.

📖 NOTE

- Make sure all lids are tightly closed when storing beverages that are in plastic bottles, etc.
- Some beverages may not be stored, depending on the size and shape of the plastic bottles, etc.

Bottle holder

Cargo area cover (if so equipped)

N00500101032

⚠ CAUTION

- Do not place luggage or other items on the cargo area cover. Any items on the cargo area cover would obstruct your rearward view, and they could fly forward and cause injuries or other mishap in the event of hard braking.

5

To install

1. Insert the concave portion (A) on the underside of the cargo area cover into the inside protruding portion (B) of the lift-gate.

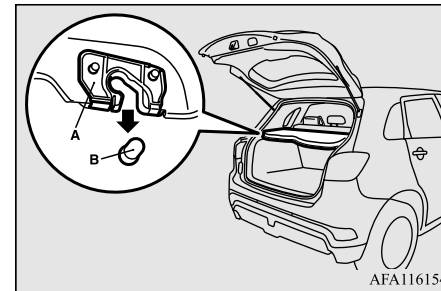

AFA116154

Assist grips

⚠ CAUTION

- Lightly push the cargo area cover to make sure that the concave portion (A) is set firmly in the protruding portion (B) of the liftgate. If the cargo area cover is not securely locked in place, it could unhook while driving and cause injuries.

5

2. Hang the strap (C) of the cargo area cover on the hook (D).

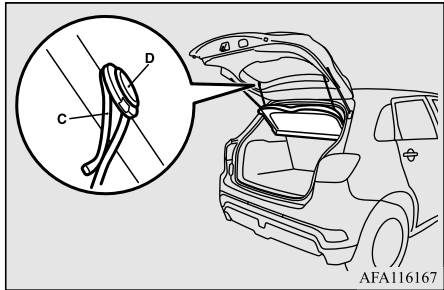

To remove

Follow this procedure in reverse to remove.

Assist grips

N0055900061

The assist grips (located above the doors on the headliner) are not designed to support

body weight. They are intended for use only while seated in the vehicle.

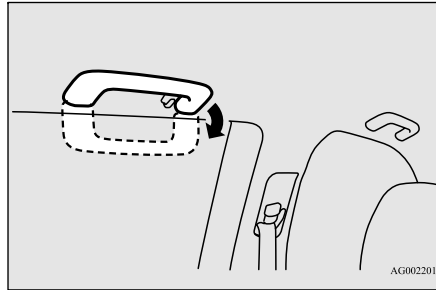

⚠ CAUTION

- Do not use the assist grips when getting into or out of the vehicle. The assist grips could detach causing you to fall.

Coat hook

N00553600153

There is a coat hook on the rear seat assist grip of the driver's side.

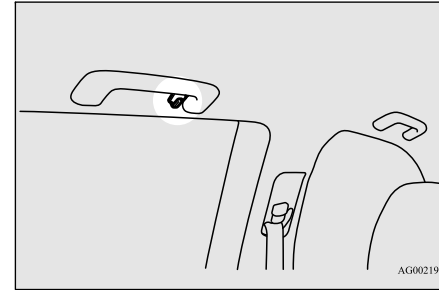

⚠ WARNING

- Do not put a hanger or any heavy or pointed object on the coat hook. If the curtain airbag was activated, any such item could be propelled away with great force and could prevent the curtain airbag from inflating correctly. Hang clothes directly on the coat hook (without using a hanger). Make sure there are no heavy or sharp objects in the pockets of clothes that you hang on the coat hook.



Luggage hooks

Luggage hooks

N00528501285

There are hooks on the sides of the luggage compartment for use in securing luggage.

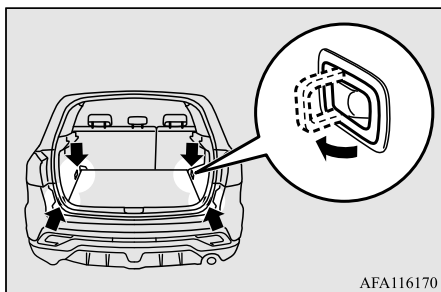

CAUTION

- Do not load the luggage higher than the top of the seatback.
Be sure that luggage is firmly secured.
Restricted rear vision or flying objects entering the passenger compartment during sudden braking could result in a serious accident.

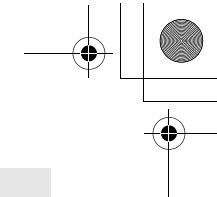

Driving safety

Driving precaution	6-2
Fuel economy	6-2
Driving, alcohol and drugs	6-2
Floor mat	6-3
Vehicle preparation before driving	6-4
Safe driving techniques	6-4
Driving during cold weather	6-5
Braking	6-5
Parking	6-6
Loading information	6-7
Cargo loads	6-10
Trailer towing	6-12

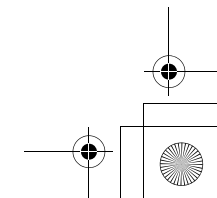
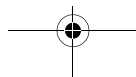
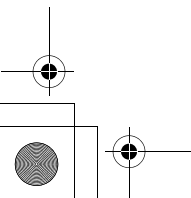
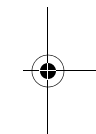
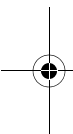

Driving precaution

Driving precaution

N00629301106

WARNING

- Utility vehicles have a significantly higher rollover rate than other types of vehicles. Avoid abrupt maneuvers and excessive speed. Always buckle up.

6

Your vehicle has been designed for both normal and occasional off-road use. However, avoid driving the vehicle through areas where the tires may get stuck in deep sand or mud as your vehicle is designed primarily for use on pavement, unlike a conventional off-road vehicle.

Keep in mind that 2-wheel drive vehicles are less capable than 4-wheel drive vehicles for driving on muddy, slippery, wet or snow-covered roads.

Utility vehicles have higher ground clearance and a narrower track, which enables them to perform in a wide variety of off-road situations. Because of the higher ground clearance, these vehicles have a higher center of gravity, which makes them handle differently than ordinary vehicles when driving on pavement. They are not designed to maneuver or corner at the same speed on pavement as conventional 2-wheel drive passenger cars any more than low-slung sports cars are designed

to perform satisfactorily in off-road conditions.

Always drive safely and steer the vehicle carefully. Avoid operating the vehicle in a manner that might require sharp turns or abrupt maneuvers. As with other vehicles of this type, failure to operate this vehicle correctly can result in loss of control or vehicle rollover.

In a rollover crash, an unbelted person is significantly more likely to die than a person wearing a seat belt. Before starting the vehicle, always make certain that you and all your passengers are properly wearing their seat belts (with children in the rear seat, in appropriate restraints).

Fuel economy

N00628800152

Fuel economy is dependent on many factors. Your personal driving habits can have a significant effect on your fuel use. Several recommendations for achieving the greatest fuel economy are listed below.

- Whenever accelerating from a stop, always accelerate slowly and smoothly.
- When parked for even a short period, do not idle the engine. Shut it off.
- Plan your trips to avoid unnecessary stops.

- Keep your tires inflated to the recommended pressures.
- When you drive on highways or dry improved roads, set the drive mode-selector “2WD” or “4WD AUTO” position (if so equipped).
- For freeway driving, maintain a speed of approximately 50 mph (80 km/h) when traffic, roadway and weather conditions safely permit.
- Keep your air filter clean and your vehicle lubricated according to the recommendations in this manual.
- Always keep your vehicle well maintained. A poorly maintained engine wastes fuel and costs money.
- Never overload your vehicle.

Driving, alcohol and drugs

N00628900049

Drunk driving is one of the most frequent causes of accidents.

Your driving ability can be seriously impaired even with blood alcohol levels far below the legal minimum. If you have been drinking, don't drive. Ride with a designated non-drinking driver, call a cab or a friend, or use public transportation. Drinking coffee or taking a cold shower will not make you sober.

Similarly, prescription and nonprescription drugs affect your alertness, perception and reaction time. Consult with your doctor or

6-2 Driving safety

pharmacist before driving while under the influence of any of these medications.

⚠ WARNING

- **NEVER DRINK AND DRIVE.**
Your perceptions are less accurate, your reflexes are slower and your judgment is impaired.

Floor mat

N00628600046

The original equipment floor mat provided with your vehicle was specifically designed for your vehicle. Always properly position the floor mat and assure it does not interfere with operation of the pedals. Always use the retaining clip on the driver's floorboard to secure the floor mat. When used, this clip will help prevent the floor mat from moving forward and possibly interfering with the operation of the pedals. To prevent the floor mat from moving forward and possibly interfering with the operation of the pedals, Mitsubishi genuine floor mats are recommended.

To install the floor mat

N00628700047

1. Place the floor mat to fit the shape of the floorboard.

2. Align the floor mat with the installation holes over the retaining clips.
3. Secure the floor mat with retaining clips.

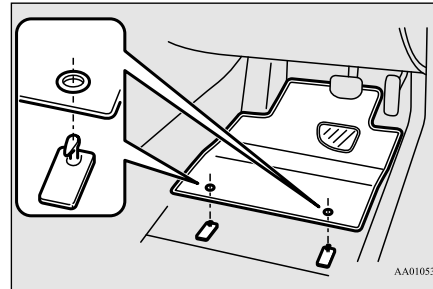

📖 NOTE

- The shape of the mat and the number of retaining clips may vary depending on the vehicle model.

⚠ WARNING

- If a floor mat is the wrong size or is not properly installed, it can interfere with the operation of the pedals. Interference with the pedals can cause unintended acceleration and/or increased stopping distances resulting in a crash and injury. Always make sure the floor mat does not interfere with the accelerator or brake pedal.
- Always use the retaining clip on the driver's floorboard to secure the floor mat.

⚠ WARNING

- Always install the mat with the correct side facing down.
- Never install a second mat over or under an existing floor mat.
- Do not use a floor mat designed for another model vehicle even if it is a Mitsubishi genuine floor mat.
- Before driving, be sure to check the following:
 - Periodically check that the floor mat is properly secured with the retaining clips. If you remove the floor mat while cleaning the inside of your vehicle or for any other reason, always check the condition of the floor mat after it has been reinstalled.
 - While the vehicle is stopped with the engine off, check that the floor mat is not interfering with the pedals by depressing the pedals fully.

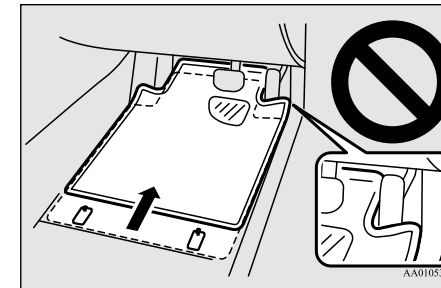

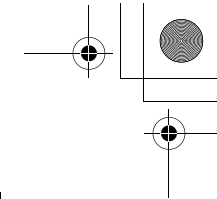

Vehicle preparation before driving

Vehicle preparation before driving

N00629000669

For a safer and more enjoyable trip, always check for the following:

Seat belts and seats

6

- Before starting the vehicle, make certain that you and all passengers are seated and wearing their seat belts properly (with children in the rear seat, in appropriate restraints), and that all the doors and lift-gate are locked.
- Move the driver's seat as far backward as possible, while still keeping good visibility, and good control of the steering wheel, brakes, accelerator, and controls. Check the instrument panel indicators and multi-information display for any possible problem.
- In the same way, the front passenger seat should also be moved as far back as possible.
- Make sure that infants and small children are properly restrained in accordance with all laws and regulations.

Defrosters

Check these by selecting the defroster mode, and set the blower switch on high. You should be able to feel the air blowing against the windshield.

Refer to “Defrosting or defogging (windshield, door windows)” on page 7-8, 7-8, 7-13, 7-18.

Tires

Check all the tires for heavy tread wear or uneven wear patterns. Look for stones, nails, glass, or other objects stuck in the tread. Look for any tread cuts or sidewall cracks. Check the wheel nuts for tightness, and the tires (including spare tire) for proper pressure. Replace your tires before they are heavily worn out.

As your vehicle is equipped with a tire pressure monitoring system, there is a risk of damage to the tire inflation pressure sensors when the tire is replaced on the rim. Tire replacement should, therefore, be performed only by an authorized Mitsubishi Motors dealer.

Lights

Have someone watch while you turn all the exterior lights on and off. Also check the turn signal indicators and high-beam indicators on the instrument panel.

Fluid leaks

Check the ground under the vehicle after parking overnight, for fuel, water, oil, or other leaks. Make sure all the fluid levels are correct. Also, if you can smell fuel, you need to find out why immediately and have it fixed.

Safe driving techniques

N00629200094

Even this vehicle's safety equipment, and your safest driving, cannot guarantee that you can avoid an accident or injury. However, if you give extra attention to the following areas, you can better protect yourself and your passengers:

- Drive defensively. Be aware of traffic, road and weather conditions. Leave plenty of stopping distance between your vehicle and the vehicle ahead.

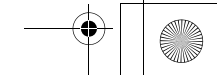
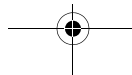

- Before changing lanes, check your mirrors and use your turn-signal light.
- While driving, watch the behavior of other drivers, bicyclists, and pedestrians.
- Always obey applicable laws and regulations. Be a polite and alert driver. Always leave room for unexpected events, such as sudden braking.
- If you plan to drive in another country, obey their vehicle registration laws and make sure you will be able to get the right fuel.

Driving during cold weather

N00629400461

- Check the battery. At the same time, check the terminals and wiring. During extremely cold weather, the battery will not be as strong. Also, the battery power level may drop because more power is used for cold starting and driving. Before driving the vehicle, check to see if the engine runs at the proper speed and if the headlights are as bright as normally. Charge or replace the battery if necessary. During extreme cold weather, it is possible that a very low battery could freeze.

WARNING

- **The battery gives off explosive hydrogen gas. Any spark or flame can cause the battery to explode, which could cause serious injury or death.**
Always wear protective clothes and a face mask when working with your battery, or let a skilled mechanic do it.

- Warm the engine sufficiently. After starting the engine, allow a short warm-up time to distribute oil to all cylinders. Then drive your vehicle slowly.
- Stay at low speeds at first so that the transaxle, transfer case and rear axle oil have time to spread to all the lubrication points.
- Manual transaxle can be harder to shift in cold weather conditions. This is normal and shifting will get easier as the transaxle warms up.
- Check the engine antifreeze. If there is not enough coolant because of a leak or from engine overheating, add Mitsubishi Motors Genuine Super Long Life Coolant Premium or equivalent. Please read this section in conjunction with the “Engine coolant” on page 9-7.

Driving during cold weather

WARNING

- **Never open the radiator cap when the radiator is hot. You could be seriously burned.**

Braking

N00629500491

6

All the parts of the brake system are critical to safety. Have the vehicle serviced by an authorized Mitsubishi Motors dealer or a repair facility of your choice at regular intervals according to the “WARRANTY AND MAINTENANCE MANUAL”.

When brakes are wet

Check the brake system while driving at a low speed immediately after starting, especially when the brakes are wet, to confirm they work normally. A film of water can be formed on the brake discs and prevent normal braking after driving in heavy rain or through large puddles, or after the vehicle is washed. If this occurs, dry the brakes out by driving slowly while lightly depressing the brake pedal.

Parking

When driving in cold weather

On snowy roads, ice can form on the braking system, making the brakes less effective. While driving in such conditions, pay close attention to preceding and following vehicles and to the condition of the road surface. From time to time, lightly depress the brake pedal and check how effective the brakes are.

6

When driving downhill

It is important to take advantage of the engine braking by downshifting while driving on steep downhill roads in order to prevent the brakes from overheating.

Parking

N00629600304

Parking on a hill

When parking on a hill, set the parking brake, and turn the front wheels toward the curb on a downhill, or away from the curb on an uphill. If necessary, apply chocks to wheels.

For vehicles equipped with manual transaxle

Place the gearshift lever into the “R” (Reverse) position when parking on a downhill slope, into the 1st position when parking on an uphill slope.

For vehicles equipped with continuously variable transmission (CVT)

Be sure that the parking brake is firmly set when parked and that the selector lever is in the “P” (PARK) position.

When parking on a hill, it is important to set the parking brake before moving the selector lever to the “P” (PARK) position. This prevents loading the parking brake against the transaxle. When this happens, it is difficult to move the selector lever out of the “P” (PARK) position.

Parking with the engine running

Never leave the engine running while you take a short sleep or rest. Also, never leave the engine running in a closed or poorly ventilated place.

WARNING

- Leaving the engine running risks injury or death from accidentally moving the gearshift lever (manual transaxle) or the selector lever (CVT) or from the accumulation of toxic exhaust fumes in the passenger compartment.

Where you park

Your front bumper can be damaged if you scrape it over curbs or parking stop blocks. Be careful when traveling up or down steep slopes where your bumper can scrape the road.

WARNING

- Do not park your vehicle in areas where combustible materials such as dry grass or leaves can come in contact with a hot exhaust, since a fire could occur.

Do not keep the steering wheel fully turned for a long time

More effort could be required to turn the steering wheel. Refer to “Electric power steering system (EPS)” on page 5-69.

When leaving the vehicle

Always remove the key from the ignition switch and lock all doors and the liftgate when leaving the vehicle unattended. Always try to park your vehicle in a well lit area.

Loading information

N00629900408

It is very important to know how much weight your vehicle can carry. This weight is called the vehicle capacity weight and includes the weight of all occupants, cargo (including the roof load), non-factory-installed options, if any, being towed. The tire and loading information placard located on the driver's door sill of your vehicle will show how much weight it may properly carry.

WARNING

- **Never overload your vehicle. Overloading can damage your vehicle, adversely affect vehicle performance, including handling and braking, cause tire failure, and result in an accident.**

It is important to familiarize yourself with the following terms before loading your vehicle:

- Vehicle maximum load on the tire: load on an individual tire that is determined by distributing to each axle its share of the maximum loaded vehicle weight and dividing by two.
- Vehicle normal load on the tire: load on an individual tire that is determined by distributing to each axle its share of the curb weight, accessory weight, and normal occupant weight and dividing by two.
- Maximum loaded vehicle weight: the sum of -
 - (a) Curb weight;
 - (b) Accessory weight;
 - (c) Vehicle capacity weight; and
 - (d) Production options weight.
- Curb weight: the weight of a motor vehicle with standard equipment including the maximum capacity of fuel, oil, and coolant.
- Accessory weight: the combined weight (in excess of those standard items which may be replaced) of automatic transmission, power steering, power brakes, power windows, power seats, radio, and heater, to the extent that these items are available as factory-installed equipment (whether installed or not).
- Vehicle capacity weight: the rated cargo and luggage load plus 150 lbs (68 kg) * times the vehicle's designated seating capacity.

Loading information

- Production options weight: the combined weight of those installed regular production options weighing over 5 lbs (2.3 kg) in excess of those standard items which they replace, not previously considered in curb weight or accessory weight, including heavy duty brakes, ride levelers, roof rack, heavy duty battery, and special trim.
- Normal occupant weight: 150 lbs (68 kg) * times the number of specified occupants. (In your vehicle the number is 3)
- Occupant distribution: Occupant distribution within the passenger compartment (In your vehicle the distribution is 2 in front, 1 in second row seat)

*:150 lbs (68 kg) is the weight of one person as defined by U.S.A. and Canadian regulations.

6

Tire and loading information placard

N00630100383

The tire and loading information placard is located on the inside sill of the driver's door.

Loading information

6

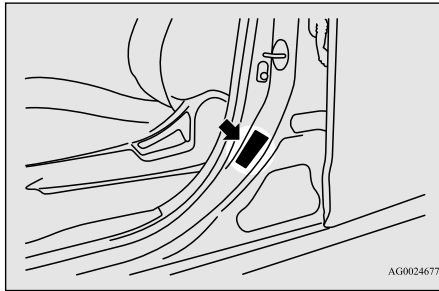

AG0024677

This placard shows the maximum number of occupants permitted to ride in your vehicle as well as “the combined weight of occupants and cargo” (A), which is called the vehicle capacity weight. The weight of roof load is included in the definition of “cargo” when determining the vehicle capacity weight. This placard also tells you the size and recommended inflation pressure for the original equipment tires on your vehicle. For more information, refer to “Tires” on page 9-14.

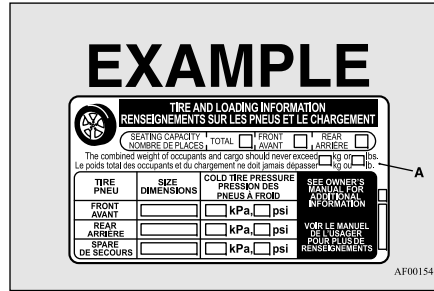

AF0015463

Steps for Determining Correct Load Limit

N00630201251

1. Locate the statement “The combined weight of occupants and cargo should never exceed XXX kg or XXX lbs.” on your vehicle’s placard.
2. Determine the combined weight of the driver and passengers that will be riding in your vehicle.
3. Subtract the combined weight of the driver and passengers from XXX kg or XXX lbs.

4. The resulting figure equals the available amount of cargo and luggage load capacity. For example, if the “XXX” amount equals 1400 lbs. and there will be five 150 lbs. passengers in your vehicle, the amount of available cargo and luggage load capacity is 650 lbs. (1400 - 750 (5 x 150) = 650 lbs.)

5. Determine the combined weight of luggage and cargo being loaded on the vehicle. That weight may not safely exceed the available cargo and luggage load capacity calculated in Step 4.

6. If your vehicle will be towing a trailer, load from your trailer will be transferred to your vehicle. Consult this manual to determine how this reduces the available cargo and luggage load capacity of your vehicle.

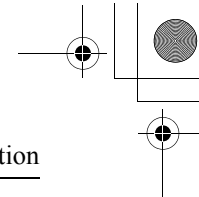

NOTE

- The above steps for determining correct load limit were written in accordance with U.S.A. regulations. Your vehicle cannot tow a trailer, so step 6 is irrelevant.

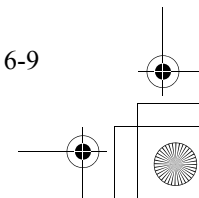
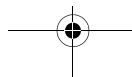
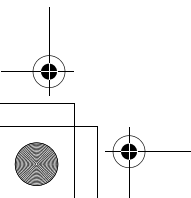
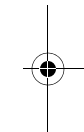
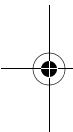

Cargo loads

6

NOTE

- The following table shows examples on how to calculate total cargo/load capacity of your vehicle with varying seating configurations and number and size of occupants. This table is for illustration purposes only and may not be accurate for the seating and load capacity of your vehicle.
- For the following example the combined weight of occupants and cargo should never exceed 865 lbs (392 kg).

Occupants			Combined weight of occupants and cargo from Tire Placard	MINUS	Combined Occupant's weight	=	AVAILABLE Cargo/Luggage Weight
TOTAL	FRONT	REAR					
EXAMPLE 1							
5	2	3	865 lbs (392 kg)	minus	Occupant 1: 200 lbs (91 kg) Occupant 2: 130 lbs (59 kg) Occupant 3: 160 lbs (73 kg) Occupant 4: 100 lbs (45 kg) Occupant 5: 80 lbs (36 kg) TOTAL WEIGHT: 670 lbs (304 kg)	=	195 lbs (88 kg)
					670 lbs (304 kg)		
EXAMPLE 2							
3	2	1	865 lbs (392 kg)	minus	Occupant 1: 210 lbs (95 kg) Occupant 2: 180 lbs (82 kg) Occupant 3: 150 lbs (68 kg) TOTAL WEIGHT: 540 lbs (245 kg)	=	325 lbs (147 kg)
					540 lbs (245 kg)		
EXAMPLE 3							
2	2	0	865 lbs (392 kg)	minus	Occupant 1: 200 lbs (91 kg) Occupant 2: 200 lbs (91 kg) TOTAL WEIGHT: 400 lbs (182 kg)	=	465 lbs (210 kg)
					400 lbs (182 kg)		

AHM100188

- Under a maximum loaded vehicle condition, gross axle weight ratings (GAWR's) for the front and rear axles must not be exceeded. For further information on GAWR's, vehicle loading, see the "Specifications" section of this manual.

Cargo loads

N00629700435

Cargo load precautions

N00630300040

To determine the cargo load capacity for your vehicle, subtract the weight of all vehicle

occupants from the vehicle capacity weight. For additional information, if needed, refer to “Steps for Determining Correct Load Limit” on page 6-8.

DO NOT USE the Gross Vehicle Weight Rating and Gross Axle Weight Rating numbers listed on the safety certification label (A) located on the inside sill of the driver’s door as the guide for passengers and/or cargo weight.

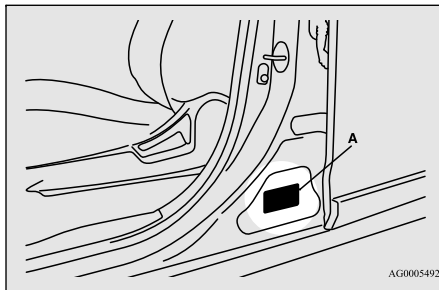

WARNING

- To reduce the risk of serious injury or death, the combined weights of the driver, passengers and cargo and must never exceed the vehicle capacity weight.
- Exceeding the vehicle capacity weight will adversely affect vehicle performance, including handling and braking, and may cause an accident.

WARNING

- Do not load cargo or luggage higher than the top of the seatback. Be sure that your cargo or luggage cannot move when your vehicle is in motion.
Having either the rear view blocked, or your cargo being thrown inside the cabin if you suddenly have to brake can cause a serious accident or injury or death.
- Put cargo or luggage in the cargo area of your vehicle. Try to spread the weight evenly.

Loading cargo on the roof

N00630400100

WARNING

- Weight placed on the roof of the vehicle will raise the vehicle’s center of gravity and adversely affect its handling characteristics. As a result, driving errors or emergency maneuvers could lead to a loss of control and result in an accident. Drive slowly and avoid excessive maneuvers such as sudden braking or quick turning.
- Make sure that the weight of luggage and the roof carrier do not exceed the maximum roof load, 176 lb (80 kg). If the maximum roof load is exceeded, this could cause damage to the vehicle or result in an accident.

WARNING

- The total weight of all occupants and luggage, including your roof load, must not exceed the vehicle capacity weight. For more information, refer to “Tire and loading information placard” on page 11-2.
- Roof load is determined by adding the weight of the roof carrier and the weight of the luggage placed on the roof carrier.
- For additional information, refer to “Maximum roof load” on page 11-3.

6

CAUTION

- Do not load luggage directly onto the roof. Use a roof carrier that properly fits your vehicle.
For installation, refer to the instruction manual provided with the roof carrier.
- Place the luggage on the carrier so that its weight is distributed evenly with the heaviest items on the bottom. Do not load items that are wider than the roof carrier.
- When attaching/removing the roof carrier and loading/removing luggage, do not apply excessive pressure on a single point. Depending on how and where the force is applied, this may cause dents on the vehicle roof.

Trailer towing

⚠ CAUTION

- Before driving and after traveling a short distance, always check the load to make sure it is securely fastened to the roof carrier. Stop the vehicle periodically and check that the load remains secure. If the load is not secure, it could fall from the vehicle and damage your vehicle, another vehicle or create a road hazard.

6

📖 NOTE

- To prevent wind noise or reduction in gas mileage, remove the roof carrier when not in use.
- Before using an automatic car wash, check with the attendant to determine if the roof carrier should be removed.
- Be sure that adequate clearance is maintained for raising the liftgate when installing a roof carrier.

Roof carrier mounting brackets (if so equipped)

N0063060085

When installing the roof carrier, use the brackets (A).
The brackets (A) are located under each cover (B).

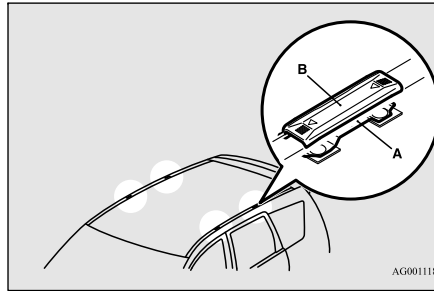

AG001181

Attaching the roof carrier

Slide each cover (B) toward the front of the vehicle to remove it.

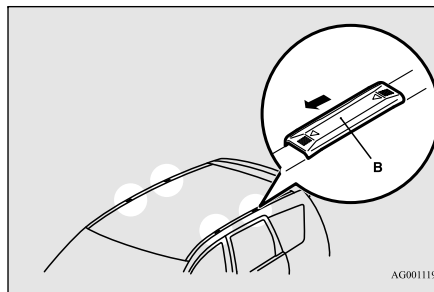

AG001194

Refitting the covers

1. With each cover, put the tabs (C) on the cover in the holes (D) in the roof.
2. Slide the cover (B) toward the rear of the vehicle to install it.

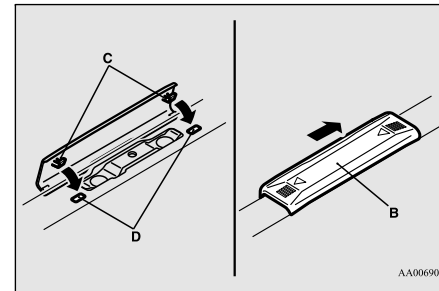

AA0069025

Trailer towing

N00629800306

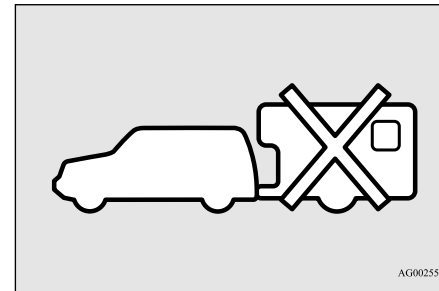

AG002528

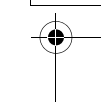
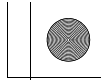
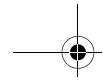
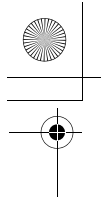

Trailer towing

⚠ WARNING

- Do not use this vehicle for trailer towing. It may not be possible to maintain control or adequate braking.

6

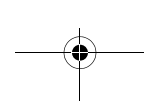
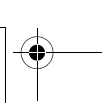
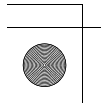
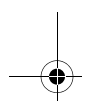
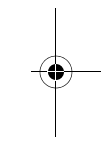
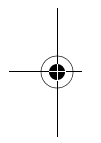

Driving safety 6-13

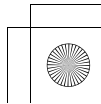
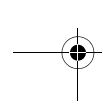
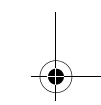

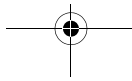
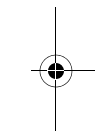
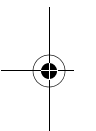

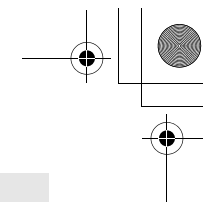

Comfort controls

Vents	7-2
Manual air conditioning	7-4
Automatic air conditioning-Type1 (if so equipped)	7-9
Automatic air conditioning-Type2 (if so equipped)	7-14
Important air conditioning operating tips	7-19
Air purifier	7-20
General information about your radio	7-20

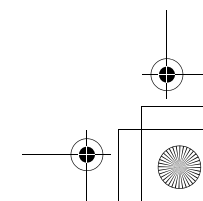
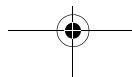
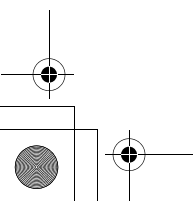
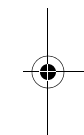
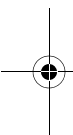

Vents

Vents

N00729900249

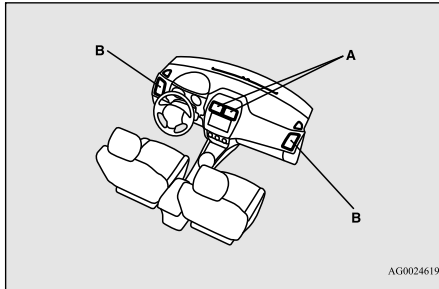

7

- A- Center vents
- B- Side vents

Air flow and direction adjustments

N00730200327

Center vents

Move the knob (A) to make adjustments.
To close the vent, move the knob (A) to the inside as far as possible.

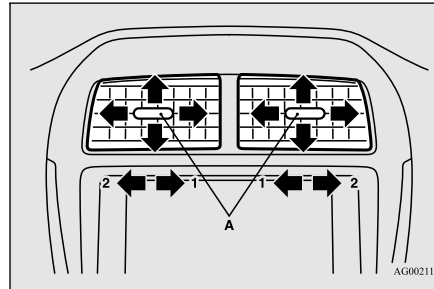

- 1- Close
- 2- Open

Side vents

Move the knob (A) to make adjustments.
To close the vent, move the knob (A) to the outside as far as possible.

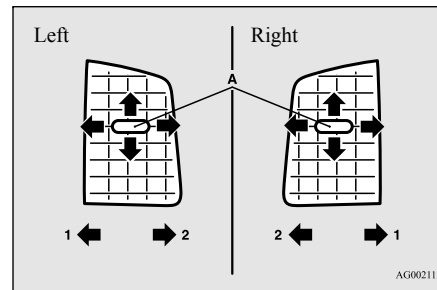

- 1- Close

2- Open

NOTE

- On rare occasions, air from the vents of an air-conditioned vehicle may be foggy. This is only moist air cooling suddenly and does not indicate a problem.
- Do not let drinks or other liquids get into the vents as they could prevent the air conditioning from operating normally.

Changing the mode selection

N00736401719

To change the position and amount of air flowing from the vents, turn the mode selection dial. Refer to "Mode selection dial" on page 7-5, 7-10, 7-16.

These symbols are used in the next several illustrations to demonstrate the quantity of air coming from the vents.

- : Small amount of air from the vents
- ➔ : Medium amount of air from the vents
- ➞ : Large amount of air from the vents

Face position

Air flows only to the upper part of the passenger compartment.

7-2 Comfort controls

Vents

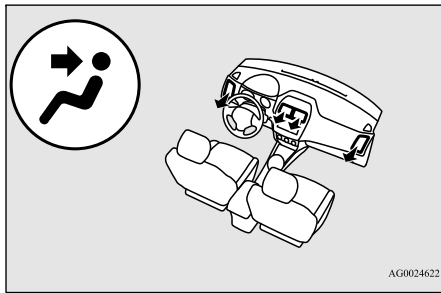

Foot/Face position

Air flows to the upper part of the passenger compartment, and flows to the leg area.

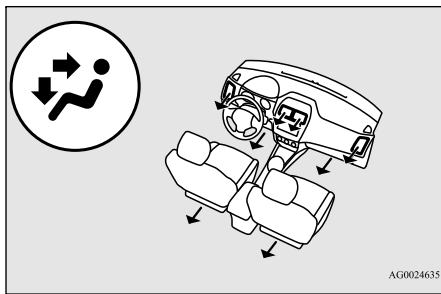

NOTE

- With the mode selection dial between the “” and “” positions, air flows mainly to the upper part of the passenger compartment. With the mode selection dial between the “” and “” positions, air flows mainly to the leg area.

Foot position

Air flows mainly to the leg area.

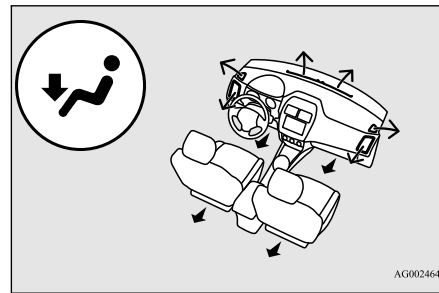

Foot/Defroster position

Air flows to the leg area, the windshield and the door windows.

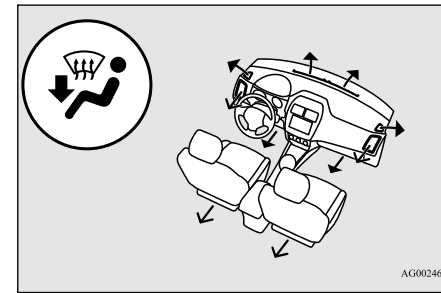

NOTE

- With the mode selection dial between the “” and “” positions, air flows mainly to the leg area. With the mode selection dial between the “” and “” positions, air flows mainly to the windshield and the door windows.

Defroster position

Air flows mainly to the windshield and the door windows.

Manual air conditioning

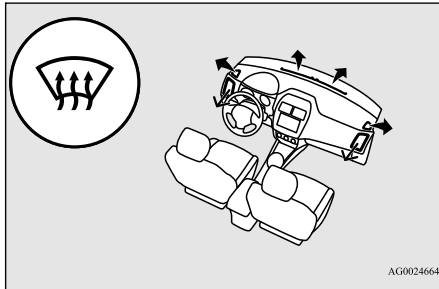

7

Manual air conditioning

N00730301413

⚠ CAUTION

- The engine speed may increase when the air conditioning is operating. With an increased engine speed, a continuously variable transmission (CVT) vehicle will creep to a greater degree than with a lower engine speed. Fully depress the brake pedal to prevent the vehicle from creeping.

Control panel

N00730500261

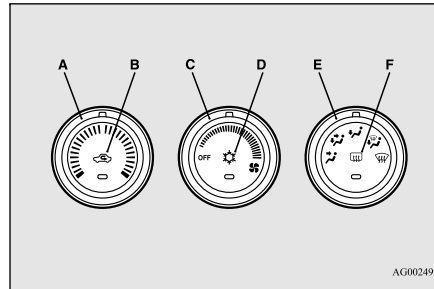

- A- Temperature control dial
- B- Air selection switch
- C- Blower speed selection dial
- D- Air conditioning switch
- E- Mode selection dial
- F- Electric rear window defogger switch→ P.5-155

Blower speed selection dial

N00736500188

When the ignition switch or the operation mode is in ON, select the blower speed by turning the blower speed selection dial. Turning the dial clockwise will increase the blower speed; turning the dial counterclockwise will decrease it. When the dial is set to the “OFF” position, all fan-driven airflow will stop.

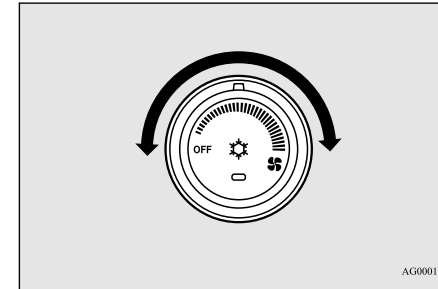

Temperature control dial

N00736600176

Turn the temperature control dial clockwise to make the air warmer. Turn it counterclockwise to make the air cooler.

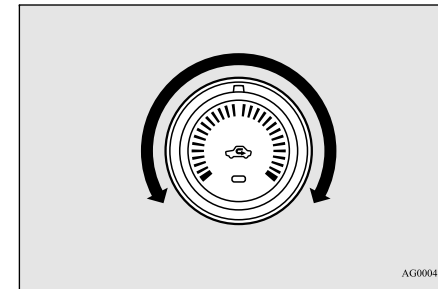

Manual air conditioning

NOTE

- While the engine coolant temperature is low, the temperature of the air from the heater will be cool/cold until the engine warms up, even if you have selected warm air with the dial.

Mode selection dial

N00736700207

To change the amount of air flowing from the vents, turn the mode selection dial. Refer to “Changing the mode selection” on page 7-2.

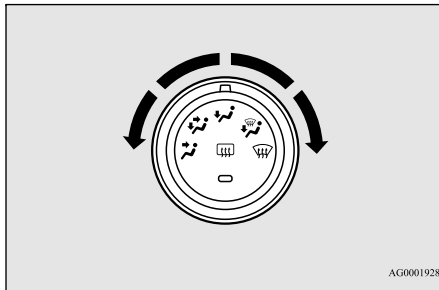

Air selection switch

N00736800396

Normally, use the outside air position to keep the windshield and side windows clear and to

quickly remove fog or frost from the windshield.

To change the air selection, simply press the air selection switch. A sound will be made every time you push the switch.

- Outside air {Indicator light (A) OFF}
- Recirculated air {Indicator light (A) ON}

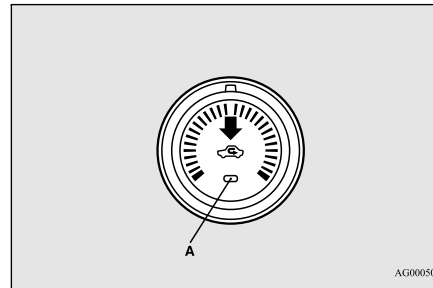

When the air conditioning turns on, the air selection is controlled automatically. The air selection indicator light (A) shows the selected position.

NOTE

- When the air conditioning operates with the air selection switch in the outside air position, the system automatically determines whether to continue using outside air or to perform recirculation. If the outside temperature is high, the system selects recirculation to achieve rapid cooling and causes the air selection indicator in the switch to illuminate. Press the air selection switch to return to outside air.

7

If the outside air is dusty or contaminated in some way, use the recirculation position. Switch to the outside air position every now and then to keep the windows from fogging up.

CAUTION

- Using recirculated air for a long time may cause the windows to fog up.

NOTE

- While the mode selection dial is set to the “” position, the air conditioning compressor will run automatically. The outside air position will also be selected automatically.

Manual air conditioning

Personalizing the air selection (Changing the function setting)

N00702100044

You can change the following functions to match your preference.

- Enable automatic air control:
When the air conditioning operates, the air selection switch will be automatically controlled.
- Disable automatic air control:
Even when the air conditioning operates, the air selection switch will not be automatically controlled.
- Changing the settings
Press the air selection switch for about 10 seconds or longer.
When the setting has changed, the system will beep and the indicator light will flash.
 - When the setting has changed from enabled to disabled, the system will beep three times and the indicator will flash three times.
 - When the setting has changed from disabled to enabled, the system will beep two times and the indicator light will flash three times.

7

NOTE

- The factory setting is “Enable automatic air control”.
- While the mode selection dial is set to the “” position, the air selection will automatically change to the outside air position, even if the system is set to “Disable automatic air control”, in order to prevent windows from fogging up.

Air conditioning switch

N00731001505

Push the switch, and the air conditioning compressor will turn on. The air conditioning indicator light (A) will come on.

A sound will be made every time you push the switch.

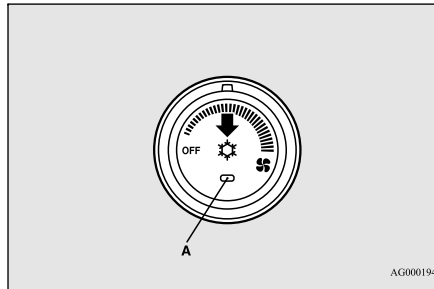

Push the switch again and the air conditioning compressor will stop and the indicator light (A) goes off.

NOTE

- If a problem is detected in the air conditioning compressor, the air conditioning indicator light (A) blinks. Press the air conditioning switch once to turn it off, then once more to turn it back on. If the air conditioning indicator light (A) does not blink, there is no problem. If it does blink, have it checked at an authorized Mitsubishi Motors dealer or a repair facility of your choice.
- Sometimes, for example after using a high-pressure car wash, the condenser can get wet, and the air conditioning indicator light (A) blinks temporarily. Wait for a while, press the air conditioning switch once to turn the system off, then once more to turn it back on. Once the water evaporates, the blinking will stop.

Operating the air conditioning system

N00731101274

Heating

Set the mode selection dial to the “” position and set the air selection switch (A) to the outside air position.

Turn the temperature control dial clockwise or counterclockwise to the desired temperature. Select the best speed to fit your needs.

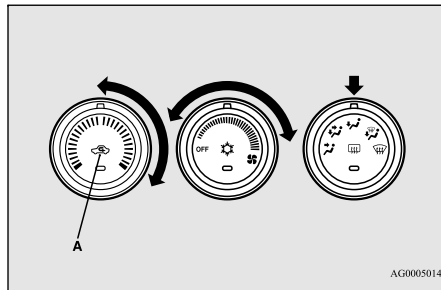

NOTE

- For quick heating, set the blower speed selection dial to the position shown in the illustration.

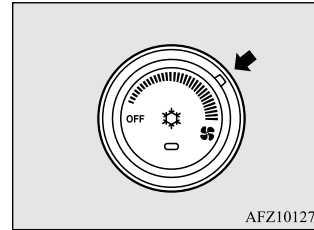

Cooling

N00731200311

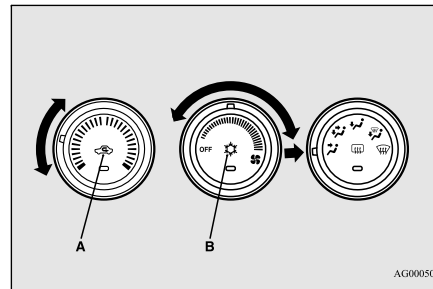

1. Set the mode selection dial to the “” position.
2. Push the air selection switch (A) to set it to the outside air position.

Manual air conditioning

3. Push the air conditioning switch (B).
4. Change the temperature by turning the control dial clockwise or counterclockwise.
5. Set the desired blower speed.

NOTE

- If the outside air is dusty or contaminated in some way, push the air selection switch (A) to set it to the recirculation position. Let in some outside air from time to time for good ventilation.
- To cool the leg areas, set the mode selection dial to the “” position.

Manual air conditioning

Combination of unheated air and heated air

N00731300266

Set the mode selection dial to the positions shown in the illustration and set the air selection switch (A) to the outside air position.

The air flow will be directed to the leg area and the upper part of the passenger compartment. Set the desired blower speed.

7

Warm air flows to the leg area and unheated or slightly warm air (depending upon the position of the temperature control dial) flows to the upper part of the passenger compartment.

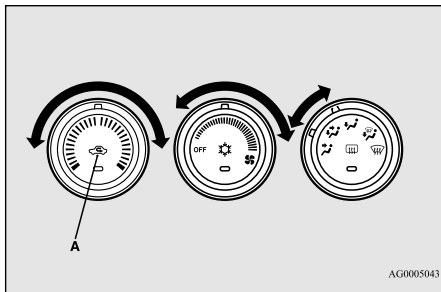

Defrosting or defogging (windshield, door windows)

N00731401583

CAUTION

- For safety, make sure you have a clear view through all the windows.

Set the mode selection dial (between “” and “”) to remove frost or mist from the windshield and door window.

For ordinary defrosting

Use this setting to keep the windshield and door windows clear of mist, and to keep the leg area heated (when driving in rain or snow).

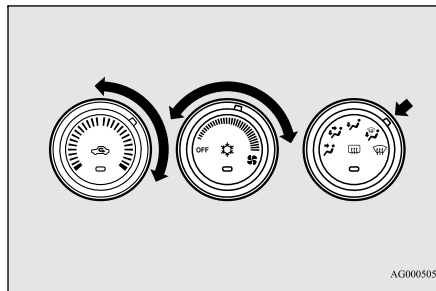

- Set the mode selection dial to the “” position.
- Select your desired blower speed by turning the blower speed selection dial.
- Select your desired temperature by turning the temperature control dial.

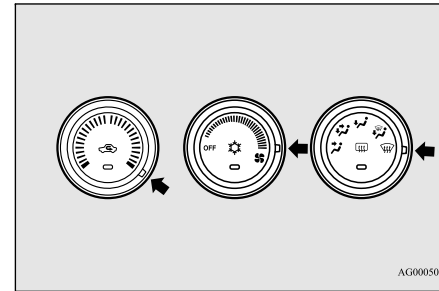

For quick defrosting



- Set the mode selection dial to the “” position.
- Set your blower to the maximum speed.
- Set the temperature to the highest position.

Automatic air conditioning-Type1 (if so equipped)

NOTE

- While the mode selection dial is set to the “” position, the air conditioning compressor will run automatically. The outside air position will also be automatically selected.
- While the “” position is selected, you cannot turn the air conditioning off or select the recirculation position.
This prevents the windows from fogging up.
- To defog quickly, direct the air flow from the side vents toward the door windows.
- When defrosting, do not set the temperature control dial near the maximum cool position. This would blow cool air on the window glass and fog it up.

Automatic air conditioning-Type1 (if so equipped)

N00731501366

CAUTION

- The engine speed may increase when the air conditioning is operating.
With an increased engine speed, a continuously variable transmission (CVT) vehicle will creep to a greater degree than with a lower engine speed. Fully depress the brake pedal to prevent the vehicle from creeping.

Control panel

N00711801608

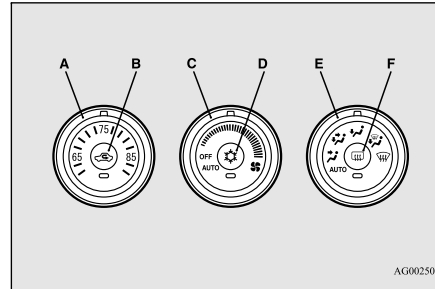

AG0025007

- A- Temperature control dial
- B- Air selection switch
- C- Blower speed selection dial
- D- Air conditioning switch
- E- Mode selection dial
- F- Electric rear window defogger switch→ P.5-155

NOTE

- There is an interior air temperature sensor (G) in the illustrated position.
Never place anything over the sensor, since doing so will prevent it from functioning properly.

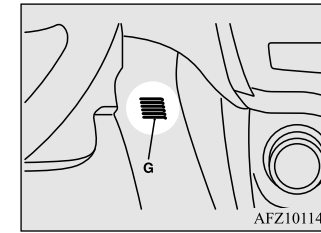

AFZ101148

7

Blower speed selection dial

N00736900153

When the ignition switch or the operation mode is in ON, select the blower speed by turning the blower speed selection dial. Turning the dial clockwise will increase the blower speed; turning the dial counterclockwise will decrease it. When the dial is set to the “OFF” position, all fan-driven airflow will stop.

Automatic air conditioning-Type1 (if so equipped)

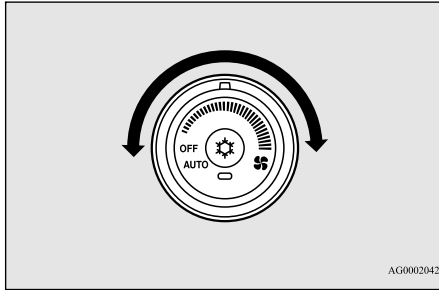

7

Temperature control dial

N00737001347

Use this dial to adjust the temperature in the passenger compartment. Turn the temperature control dial clockwise to make the air warmer. Turn it counterclockwise to make the air cooler.

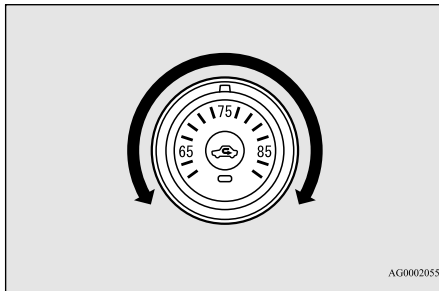

NOTE

- While the engine coolant temperature is low, the temperature of the air from the heater will be cool/cold until the engine warms up, even if you have selected warm air with the dial.
- When the temperature is set to the highest or the lowest setting under the AUTO operation, the air selection and the air conditioning will be automatically changed as follows.
 - Quick Heating (When the temperature is set to the highest setting)
Outside air will be introduced and the air conditioning will stop. In this case, manual operation is possible.
 - Quick Cooling (When the temperature is set to the lowest setting)
Inside air will be recirculated and the air conditioning will operate. In this case, you cannot select outside air and turn the air conditioning off.

The above indicates the factory settings. You can personalize the air selection switch and air conditioning switch to match your personal preferences.

Contact your Mitsubishi Motors dealer or a repair facility of your choice for assistance. Refer to “Personalizing the air conditioning switch (Changing the function setting)” on page7-12.

Refer to “Personalizing the air selection (Changing the function setting)” on page7-11.

Mode selection dial

N00737100093

To change the amount of air flowing from the vents, turn the mode selection dial. Refer to “Changing the mode selection” on page 7-2.

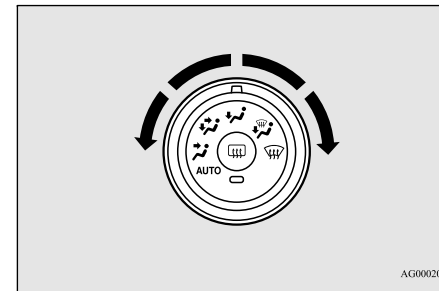

Air selection switch

N00737200339

Normally, use the outside air position to keep the windshield and side windows clear and to quickly remove fog or frost from the windshield.

To change the air selection, simply press the air selection switch. A sound will be made every time you press the switch.

- Outside air {Indicator light (A) OFF}
Outside air is introduced into the passenger compartment.

Automatic air conditioning-Type1 (if so equipped)

- Recirculated air {Indicator light (A) ON}
Air is recirculated inside the passenger compartment.

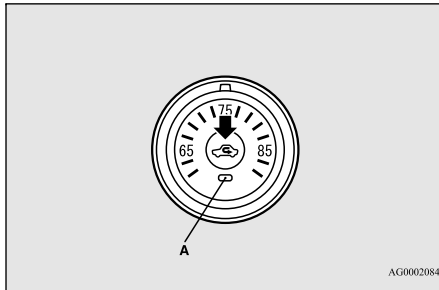

When the air conditioning turns on, the air selection is controlled automatically. When the air conditioning turns off, the air selection automatically goes back to the outside air position.

If high cooling performance is desired, or if the outside air is dusty or contaminated in some way, use the recirculation position. Switch to the outside air position every now and then to keep the windows from fogging up.

CAUTION

- Using recirculated air for a long time may cause the windows to fog up.

NOTE

- If the mode selection dial is set between “” and “”, you cannot turn the air conditioning off or select the recirculation position. This prevents the windows from fogging up.
- When the mode selection dial or the blower speed selection dial is set to the “AUTO” position again after manual operation, the air selection switch will also be automatically controlled.

Personalizing the air selection (Changing the function setting)

N00760001103

You can change the following functions to match your preference.

- Enable automatic air control:
When the mode selection dial or the blower speed selection dial is set to the “AUTO” position, the air selection switch will also be automatically controlled.
- Disable automatic air control:
Even when the mode selection dial or the blower speed selection dial is set to the “AUTO” position, the air selection switch will not be automatically controlled.
- Changing the settings

Press the air selection switch for about 10 seconds or longer.

When the setting has changed, the system will beep and the indicator light will flash.

- When the setting has changed from enabled to disabled, the system will beep three times and the indicator will flash three times.
- When the setting has changed from disabled to enabled, the system will beep two times and the indicator light will flash three times.

7

NOTE

- The factory setting is “Enable automatic air control”.
- While the mode selection dial is set between “” and “” position, the air selection will automatically change to the outside air position, even if the system is set to “Disable automatic air control”, in order to prevent windows from fogging up.

Air conditioning switch

N00737301412

Push the switch, and the air conditioning compressor will turn on. The air conditioning indicator light (A) will come on.

A sound will be made every time you push the switch.

Automatic air conditioning-Type1 (if so equipped)

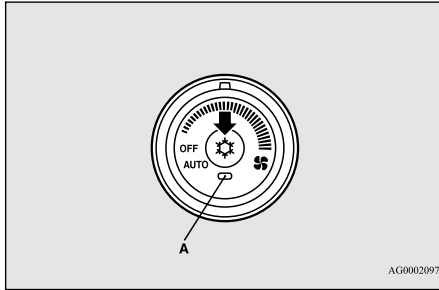

7

Push the switch again and the air conditioning compressor will stop and the indicator light (A) goes off.

NOTE

- If a problem is detected in the air conditioning compressor, the air conditioning indicator light (A) blinks. Press the air conditioning switch once to turn it off, then once more to turn it back on. If the air conditioning indicator light does not blink there is no problem. If it does blink, have it checked at an authorized Mitsubishi Motors dealer or a repair facility of your choice.
- Sometimes, for example after using a high-pressure car wash, the condenser can get wet, and the air conditioning indicator light (A) blinks temporarily. Wait for a while, press the air conditioning switch once to turn the system off, then once more to turn it back on. Once the water evaporates, the blinking will stop.

Personalizing the air conditioning switch (Changing the function setting)

N00759800045

You can change the following functions to match your preference.

- **Enable automatic air conditioning control:**
When the mode selection dial or blower speed selection dial has been set to the “AUTO” position or when the temperature control dial has been set to the minimum temperature, the air conditioning switch is automatically controlled.
- **Disable automatic air conditioning control:**
The air conditioning switch is not automatically controlled, unless the air conditioning switch is used.
- **Changing the settings**
Press the air conditioning switch for about 10 seconds or longer. When the setting has changed, the system will beep and the indicator light will flash.
 - When the setting has changed from enabled to disabled, the system will beep three times and the indicator will flash three times.
 - When the setting has changed from disabled to enabled,

the system will beep two times and the indicator light will flash three times.

NOTE

- The factory setting is “Enable automatic air conditioning control”.
- While the mode selection dial is set between “” and “” position, the air conditioning will run automatically, even if the system is set to “Disable automatic air conditioning control”, in order to prevent windows from fogging up.

Operating the air conditioning system (automatic mode)

N00731701456

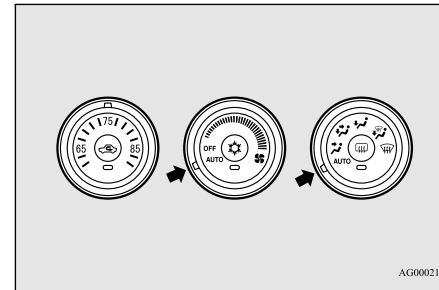

In normal conditions, use the system in the AUTO mode and follow these procedures:

Automatic air conditioning-Type1 (if so equipped)

1. Set the blower speed selection dial to the "AUTO" position.
2. Select the temperature control dial to the desired temperature. The temperature can be set within a range of around 61 to 89. The temperature will increase as the dial is turned to the right.
3. Set the mode selection dial to the "AUTO" position.

The vents, recirculation/outside air, blower speed, and ON/OFF of air conditioning will be controlled automatically.

NOTE

- Set the temperature at about 75 under normal conditions.
- While the engine coolant temperature is low, the temperature of the air from the heater will be cool/cold until the engine warms up, even if you have selected warm air with the dial. To prevent the windshield and windows from fogging up, the vent mode will be changed to "FF" or "FF" and the blower speed will be reduced.

Operating the air conditioning system (manual mode)

N00731800072

Blower speed and vent mode may be controlled manually by setting the blower speed

selection dial and the mode selection dial to the desired positions. To return to automatic operation, set the dials to the "AUTO" position.

Defrosting or defogging (windshield, door windows)

N00732401492

CAUTION

- For safety, make sure you have a clear view through all the windows.

To remove frost or mist from the windshield and door windows, use the mode selection dial ("FF" or "FF").

■ For ordinary defrosting

Use this setting to keep the windshield and door windows clear of mist, and to keep the leg area heated (when driving in rain or snow).

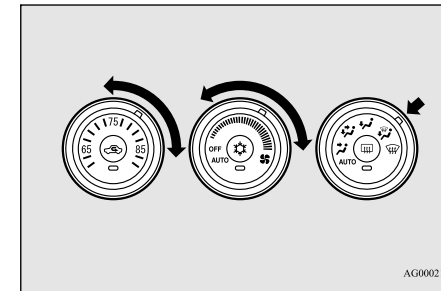

1. Set the mode selection dial to the "FF" position.
2. Select your desired blower speed by turning the blower speed selection dial.
3. Select your desired temperature by turning the temperature control dial.

Automatic air conditioning-Type2 (if so equipped)

■ For quick defrosting

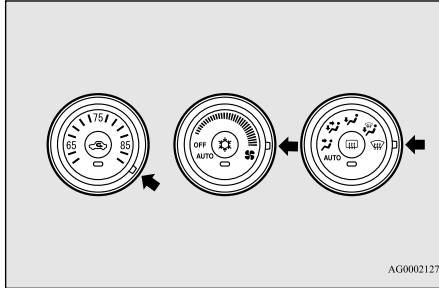

7

1. Set the mode selection dial to the “” position.
2. Set your blower to the maximum speed.
3. Set the temperature to the highest position.

NOTE

- While the mode selection dial is set between “” and “”, the air conditioning compressor will run automatically. The outside air position will also be selected automatically.
- If the mode selection dial is set between “” and “” you cannot turn the air conditioning off or select the recirculation position. This prevents the windows from fogging up.
- To defog quickly, direct the air flow from the side vents toward the door windows.

NOTE

- When defrosting, do not set the temperature control dial to the maximum cool position. This will blow cool air on the window glass and fog it up.

Automatic air conditioning-Type2 (if so equipped)

N00731501379

CAUTION

- The engine speed may increase when the air conditioning is operating. With an increased engine speed, a continuously variable transmission (CVT) vehicle will creep to a greater degree than with a lower engine speed. Fully depress the brake pedal to prevent the vehicle from creeping.

Control panel

N00711801611

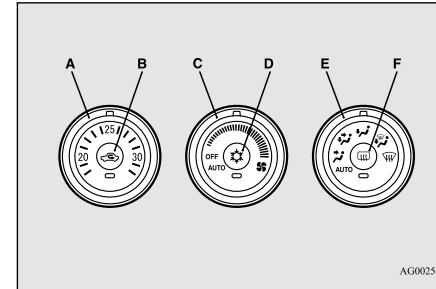

- A- Temperature control dial
- B- Air selection switch
- C- Blower speed selection dial
- D- Air conditioning switch
- E- Mode selection dial
- F- Electric rear window defogger switch→ P.5-155

Automatic air conditioning-Type2 (if so equipped)

NOTE

- There is an interior air temperature sensor (G) in the illustrated position. Never place anything over the sensor, since doing so will prevent it from functioning properly.

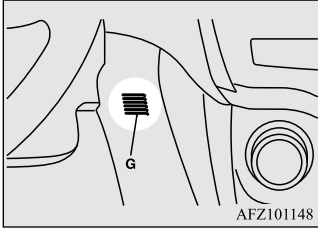

AFZ101148

Blower speed selection dial

N00736900166

When the ignition switch or the operation mode is in ON, select the blower speed by turning the blower speed selection dial. Turning the dial clockwise will increase the blower speed; turning the dial counterclockwise will decrease it. When the dial is set to the "OFF" position, all fan-driven airflow will stop.

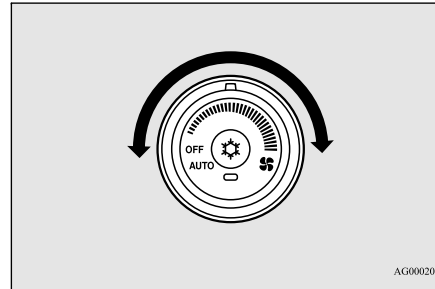

Temperature control dial

N00737000308

Use this dial to adjust the temperature in the passenger compartment. Turn the temperature control dial clockwise to make the air warmer. Turn it counterclockwise to make the air cooler.

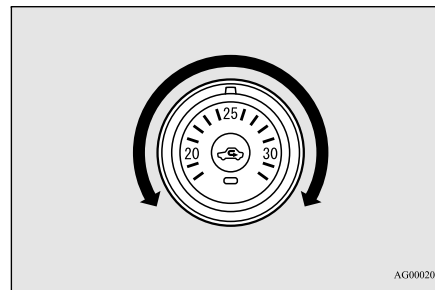

NOTE

- While the engine coolant temperature is low, the temperature of the air from the heater will be cool/cold until the engine warms up, even if you have selected warm air with the dial.
- When the temperature is set to the highest or the lowest setting under the AUTO operation, the air selection and the air conditioning will be automatically changed as follows. Also, if the air selection is operated manually after an automatic changeover, manual operation will be selected.
 - Quick Heating (When the temperature is set to the highest setting)
 - Outside air will be introduced and the air conditioning will stop.
 - Quick Cooling (When the temperature is set to the lowest setting)
 - Inside air will be recirculated and the air conditioning will operate.

The above indicates the factory settings. You can personalize the air selection switch and air conditioning switch to match your personal preferences.

Contact your Mitsubishi Motors dealer or a repair facility of your choice for assistance. Refer to "Personalizing the air conditioning switch (Changing the function setting)" on page 7-17.

Refer to "Personalizing the air selection (Changing the function setting)" on

Automatic air conditioning-Type2 (if so equipped)

page7-16.

Mode selection dial

N00737100136

To change the amount of air flowing from the vents, turn the mode selection dial. Refer to “Changing the mode selection” on page 7-2.

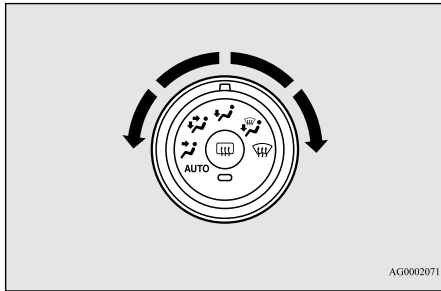

AG0002071

Air selection switch

N00737200342

Normally, use the outside air position to keep the windshield and side windows clear and to quickly remove fog or frost from the windshield.

To change the air selection, simply press the air selection switch. A sound will be made every time you press the switch.

- Outside air {Indicator light (A) OFF}

7-16 Comfort controls

Outside air is introduced into the passenger compartment.

- Recirculated air {Indicator light (A) ON}
Air is recirculated inside the passenger compartment.

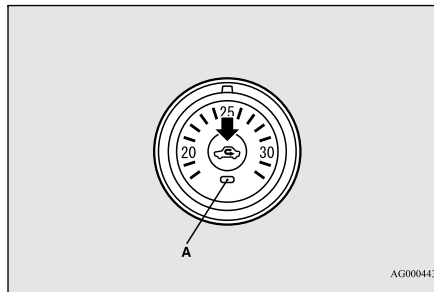

AG0004437

When the air conditioning turns on, the air selection is controlled automatically. When the air conditioning turns off, the air selection automatically goes back to the outside air position.

If high cooling performance is desired, or if the outside air is dusty or contaminated in some way, use the recirculation position. Switch to the outside air position every now and then to keep the windows from fogging up.

⚠ CAUTION

- Using recirculated air for a long time may cause the windows to fog up.

Personalizing the air selection (Changing the function setting)

N0076000021

You can change the following functions to match your preference.

- Enable automatic air control:
When the mode selection dial or the blower speed selection dial is set to the “AUTO” position, the air selection switch will also be automatically controlled.
- Disable automatic air control:
Even when the mode selection dial or the blower speed selection dial is set to the “AUTO” position, the air selection switch will not be automatically controlled.
- Changing the settings
Press the air selection switch for about 10 seconds or longer.
When the setting has changed, the system will beep and the indicator will flash.
 - When the setting has changed from enabled to disabled, the system will beep three times and the indicator will flash three times.
 - When the setting has changed from disabled to enabled, the system will beep two times and the indicator light will flash three times.

Automatic air conditioning-Type2 (if so equipped)

NOTE

- The factory setting is “Enable automatic air control”.
- While the mode selection dial is set to the “” position, the air selection will automatically change to the outside air position, even if the system is set to “Disable automatic air control”, in order to prevent windows from fogging up.

Air conditioning switch

N00737301425

Push the switch, and the air conditioning compressor will turn on. The air conditioning indicator light (A) will come on. A sound will be made every time you push the switch.

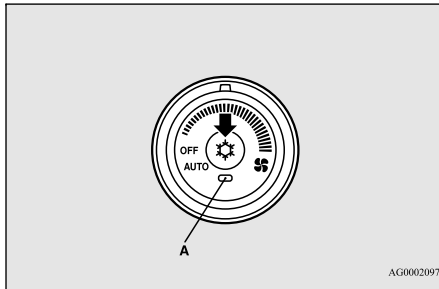

Push the switch again and the air conditioning compressor will stop and the indicator light (A) goes off.

NOTE

- If a problem is detected in the air conditioning compressor, the air conditioning indicator light (A) blinks. Press the air conditioning switch once to turn it off, then once more to turn it back on. If the air conditioning indicator light does not blink there is no problem. If it does blink, have it checked at an authorized Mitsubishi Motors dealer or a repair facility of your choice.
- Sometimes, for example after using a high-pressure car wash, the condenser can get wet, and the air conditioning indicator light (A) blinks temporarily. Wait for a while, press the air conditioning switch once to turn the system off, then once more to turn it back on. Once the water evaporates, the blinking will stop.

Personalizing the air conditioning switch (Changing the function setting)

N00759800029

You can change the following functions to match your preference.

- Enable automatic air conditioning control:

When the mode selection dial or blower speed selection dial has been set to the “AUTO” position or when the temperature control dial has been set to the minimum temperature, the air conditioning switch is automatically controlled.

- Disable automatic air conditioning control:
The air conditioning switch is not automatically controlled, unless the air conditioning switch is used.
- Changing the settings
Press the air conditioning switch for about 10 seconds or longer. When the setting has changed, the system will beep and the indicator light will flash.
 - When the setting has changed from enabled to disabled, the system will beep three times and the indicator will flash three times.
 - When the setting has changed from disabled to enabled, the system will beep two times and the indicator light will flash three times.

7

NOTE

- The factory setting is “Enable automatic air conditioning control”.

Automatic air conditioning-Type2 (if so equipped)

NOTE

- While the mode selection dial is set to the “” position, the air conditioning will run automatically, even if the system is set to “Disable automatic air conditioning control”, in order to prevent windows from fogging up.

Operating the air conditioning system (automatic mode)

7

N00731701469

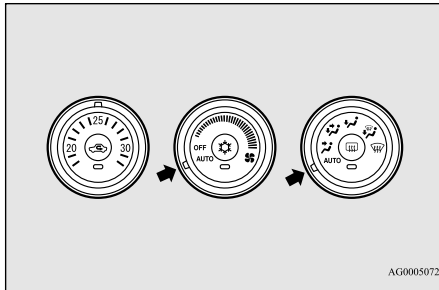

AG0005072

In normal conditions, use the system in the AUTO mode and follow these procedures:

- Set the blower speed selection dial to the “AUTO” position.

- Select the temperature control dial to the desired temperature. The temperature can be set within a range of around 18 to 32. The temperature will increase as the dial is turned to the right.
- Set the mode selection dial to the “AUTO” position.

The vents, recirculation/outside air, blower speed, and ON/OFF of air conditioning will be controlled automatically.

NOTE

- Set the temperature at about 25 under normal conditions.
- While the engine coolant temperature is low, the temperature of the air from the heater will be cool/cold until the engine warms up, even if you have selected warm air with the dial. To prevent the windshield and windows from fogging up, the vent mode will be changed to “” or “” and the blower speed will be reduced.

Operating the air conditioning system (manual mode)

N00731800098

Blower speed and vent mode may be controlled manually by setting the blower speed selection dial and the mode selection dial to the desired positions. To return to automatic

operation, set the dials to the “AUTO” position.

Defrosting or defogging (windshield, door windows)

N00732401489

CAUTION

- For safety, make sure you have a clear view through all the windows.

To remove frost or mist from the windshield and door windows, use the mode selection dial (“” or “”).

For ordinary defrosting

Use this setting to keep the windshield and door windows clear of mist, and to keep the leg area heated (when driving in rain or snow).

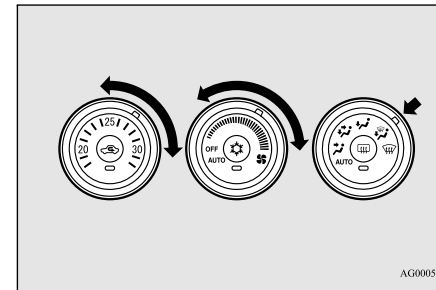

AG0005085

1. Set the mode selection dial to the “” position.
2. Select your desired blower speed by turning the blower speed selection dial.
3. Select your desired temperature by turning the temperature control dial.

■ For quick defrosting

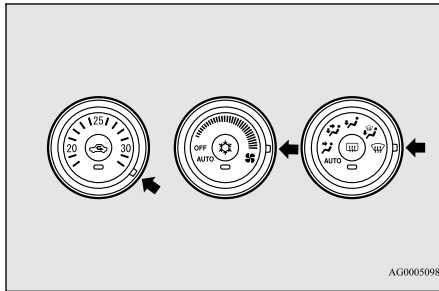

1. Set the mode selection dial to the “” position.
2. Set your blower to the maximum speed.
3. Set the temperature to the highest position.

NOTE

- While the mode selection dial is set to the “” position, the air conditioning compressor will run automatically. The outside air position will also be selected automatically.

NOTE

- While the “” position is selected, you cannot turn the air conditioning off or select the recirculation position. This prevents the windows from fogging up.
- To defog quickly, direct the air flow from the side vents toward the door windows.
- When defrosting, do not set the temperature control dial to the maximum cool position. This will blow cool air on the window glass and fog it up.

Important air conditioning operating tips

N00733701388

1. Park the vehicle in the shade whenever possible. Parking in the hot sun makes the vehicle interior extremely hot which then requires more time to cool. If it is necessary to park in the sun, open the windows for the first few minutes of air conditioning to expel the hot air.
2. Afterwards, keep the windows closed when the air conditioning is in use. The entry of outside air through open windows will reduce cooling efficiency.

Important air conditioning operating tips

3. When running the air conditioning, make sure the air intake, which is located in front of the windshield, is free of obstructions such as leaves. Leaves collected in the air-intake chamber may reduce air flow and plug the water drains.

Air conditioning system refrigerant and lubricant recommendations

7

If the air conditioning seems less effective than usual, the cause might be a refrigerant leak.

Have the system inspected by your authorized Mitsubishi Motors dealer or a repair facility of your choice.

Air purifier

CAUTION

- The air conditioning system in your vehicle must be charged with the refrigerant HFC-134a and the lubricant SUN-PAG56 or PAG46A. Use of any other refrigerant or lubricant will cause severe damage and may require replacing your vehicle's entire air conditioning system. The release of refrigerant into the atmosphere is not recommended. The new refrigerant HFC-134a in your vehicle is designed not to harm the earth's ozone layer. However, it may contribute slightly to global warming. It is recommended that the old refrigerant be saved and recycled for future use.

7

During a long period of disuse

The air conditioning should be operated for at least five minutes each week, even in cold weather. This includes the quick defrosting mode. Operating the air condition system weekly maintains lubrication of the compressor internal parts to keep the air conditioning in the best operating condition.

Air purifier

N00733800151

The air conditioning system is equipped with an air filter to remove pollen and dust. The air filter's ability to collect pollen and dirt is reduced as it becomes dirty, so replace it periodically. For the maintenance interval, refer to the "WARRANTY AND MAINTENANCE MANUAL".

NOTE

- Operation in certain conditions such as driving on a dusty road and frequent use of the air conditioning can lead to reduction of service life of the filter. When you feel that the air flow is lower than normal or when the windshield or windows start to fog up easily, replace the air filter. Contact your Mitsubishi Motors dealer or a repair facility of your choice for assistance.

General information about your radio

N00733901511

Your vehicle's radio receives both AM and FM stations. The quality of your reception is affected by distance, obstacles, and signal interference.

This radio complies with Part 15 of Federal Communications Commission (FCC) Rules (for vehicles sold in U.S.A.). Operation is subject to the following conditions:

- The device may not cause harmful interference.
- This device must accept any interference received, including interference that may cause undesirable operation.

CAUTION

- Changes or modifications not expressly approved by the party meeting the above conditions could void the user's authority to operate the equipment.

Signal transmission

FM signals do not follow the earth surface nor are they reflected by the upper atmosphere. For this reason, FM broadcasts cannot be received over long distances. AM signals follow the earth's surface and are reflected by the upper atmosphere. For this reason, AM broadcasts can be received over longer distances.

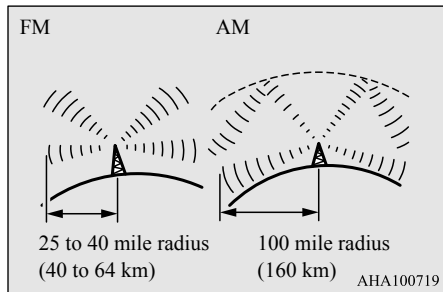

Weak reception (fading)

Because of the limited range of FM signals and the way FM waves transmit, you may experience weak or fading FM reception. When the broadcast is blocked by mountains or similar obstructions, reception can be disturbed.

Reflection

The reason why one can hear FM but not AM in parking garages, under bridges etc., is that FM signals, unlike AM signals, are reflected by solid objects such as buildings, etc. Because FM signals are easily reflected by buildings, this can also cause reception disturbances.

The direct signal from the broadcast station reaches the antenna slightly before the reflected signal. This time difference may cause some reception disturbance or flutter. This problem occurs primarily in urban areas.

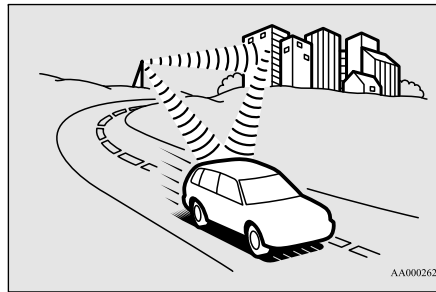

Cross modulation

If one listens to a weak station and is in the vicinity of another strong station, both stations might be received simultaneously.

General information about your radio

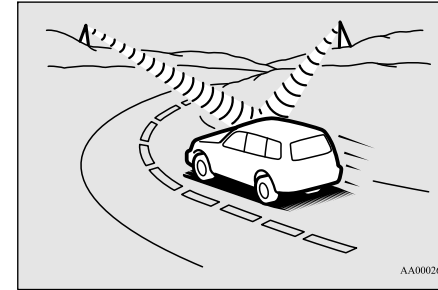

7

FM stereo reception

Stereo reception requires a high quality broadcast signal. This means that types of disturbances mentioned previously become more marked and the reception range is somewhat diminished during stereo reception.

Causes of disturbances

FM reception is affected by the electrical systems of vehicles in the vicinity, especially those without an electronic noise suppression device. The disturbance is even greater if the station is weak or poorly tuned.

FM reception is not as sensitive to electrical disturbances as AM. AM reception is sensitive to electrical disturbances such as power

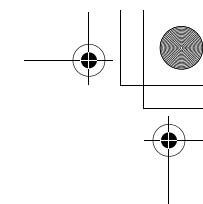

General information about your radio

lines, lightning and other types of similar electrical phenomena.

7

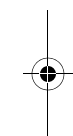
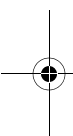
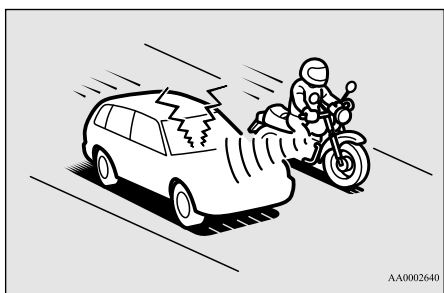

7-22 Comfort controls

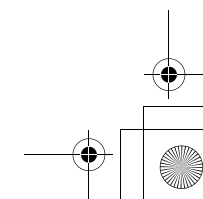
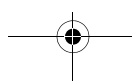
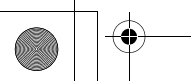

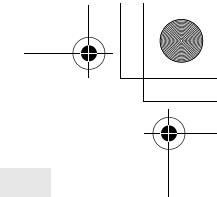

For emergencies

If the vehicle breaks down	8-2
Jump-starting the engine	8-2
Engine overheating	8-4
Jack and tools	8-5
How to change a tire	8-6
Towing	8-12
Operation under adverse driving conditions	8-14
Fuel Pump Shut-off System	8-15

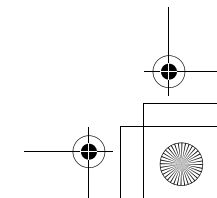
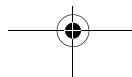
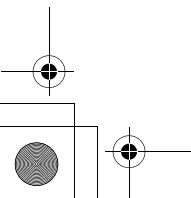
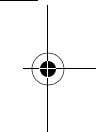
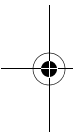

If the vehicle breaks down

If the vehicle breaks down

N00836300187

If your vehicle breaks down on the road, move to the shoulder and turn on the hazard warning flashers. If there is no shoulder, or the shoulder is not safe, drive in the right lane slowly, with the hazard lights flashing, until you come to a safe stopping place. Keep the flashers flashing.

If the engine stops/fails

8

If the engine stops, there will be no power assist to the steering and brakes, making these difficult to use.

- The brake booster will not work, so the brakes will not grip well. The brake pedal will be harder to press than usual.
- Since there is no power steering assist, the steering wheel will be hard to turn.

When the engine fails at the intersection

Get help from your passengers, bystanders, etc. to push the vehicle and move it to a safe zone.

8-2 For emergencies

Jump-starting the engine

N00836401824

If the engine cannot be started because the battery is weak or dead, you can start it with the battery from another vehicle using jumper cables.

WARNING

- When using jumper cables to start a vehicle, follow the procedures and be very cautious.

CAUTION

- Do not try to start your vehicle by pushing or towing. Vehicles with automatic transaxles cannot be started this way. Also, there is more risk of an accident when a vehicle is being pushed or towed.

1. Take off any metal jewelry such as watch bands or bracelets that might make an accidental electrical contact.
2. Position the vehicles close enough together so that the jumper cables can reach, but be sure the vehicles aren't touching each other.

CAUTION

- Check the other vehicle. It must have a 12-volt battery. If the other system isn't 12-volt, both systems can be damaged.

3. You could be injured if the vehicles move. Set the parking brake firmly on each vehicle. Put an automatic transaxle or CVT in "P" (PARK) or a manual transaxle in "N" (Neutral).
4. Turn the ignition switch to the "OFF" position or put the operation mode in OFF.

WARNING

- Perform step 4 on both vehicles beforehand. Make sure that the cables or your clothes cannot be caught by the fan or drive belt. Personal injury could result.

NOTE

- Turn off all lights, heater, and other electrical loads. This will avoid sparks and help save both batteries.

5. Make sure your battery electrolyte is at the proper level.
(Refer to "Battery" on page 9-11.)

Jump-starting the engine

⚠ WARNING

- If the electrolyte fluid is not visible, or looks frozen, **DO NOT ATTEMPT JUMP STARTING!!**

The battery might split open or explode if the temperature is below the freezing point or if it is not filled to the proper level.

6. Connect one end of one jumper cable to the positive (+) terminal of the discharged battery (A), and the other end to the positive (+) terminal of the booster battery (B).

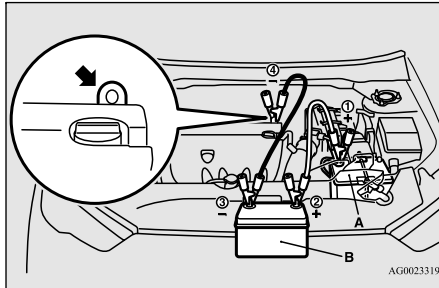

📖 NOTE

- Open the terminal cover before connecting the jumper cable to the positive terminal of the battery.
(Refer to "Battery" on page 9-11.)

📖 NOTE

- Use the proper cables suitable for the battery size.
Otherwise heat damage to the cables could result.
- Check the jumper cables for damage and corrosion before use.

7. Connect one end of the other jumper cable to the negative (-) terminal of the booster battery (B), and the other end to the engine block of the vehicle with the low battery (A) at the point farthest from the battery.

⚠ WARNING

- Be sure to follow the proper order when connecting the batteries, of:
①→②→③→④
- Make sure that the connection ④ is made to the engine properly. If the connection is directly made to the negative terminal of the battery, the flammable gases from inside the battery might catch fire and explode, causing personal injury.
- When connecting the jumper cable, do not connect the positive (+) cable to the negative (-) terminal. Otherwise sparks can make the battery explode.

⚠ CAUTION

- Make sure that the jumper cable will not be caught in the cooling fan or other moving parts in the engine compartment.

8. Start the engine in the vehicle providing the boost. Let the engine idle a few minutes, then start the engine in the vehicle with the low battery.
9. After the engine is started, disconnect the cables in the reverse order from the way you connected them.

8

⚠ WARNING

- Charging your battery while it is still in your vehicle might cause the battery to catch fire and explode. If you have to charge it while in the vehicle, disconnect the negative (-) terminal.
- Keep sparks, cigarettes, and flames away from the battery because the battery could explode.
- Keep your work area well vented when charging or using the battery in an enclosed space.
- Remove all the caps before charging the battery.

Engine overheating

⚠ WARNING

- **Electrolyte (battery acid) is made of corrosive diluted sulfuric acid. If electrolyte comes in contact with your hands, eyes, clothes, or the painted surface of your vehicle, thoroughly flush with water. If electrolyte gets in your eyes, flush them immediately and thoroughly with water, and get prompt medical attention.**
- **Always wear protective clothing and goggles when working near the battery.**
- **Keep the battery out of the reach of children.**

8

As your vehicle has anti-lock brakes

If you drive your vehicle with a low battery charge after the engine has been started by using jumper cables, the engine may misfire. This can cause the anti-lock braking system warning light to blink on and off. This is only due to the low battery voltage. It is not a problem with the brake system. If this happens, fully charge the battery and ensure the charging system is operating properly.

Engine overheating

N00836500352

When the engine is overheating, the information screen in the multi-information display

8-4 For emergencies

will be interrupted and the engine coolant temperature warning display will appear.

Also  blink. If this happens:

1. Stop the vehicle in a safe place. Turn on the hazard warning flashers.
2. With the engine still running, carefully raise the engine hood to vent the engine compartment.
3. Check that the cooling fan is running. If the fan is not turning, stop the engine immediately and contact an authorized Mitsubishi Motors dealer or a repair facility of your choice for assistance.

⚠ WARNING

- **To avoid personal injury, keep hands, hair, jewelry and clothes away from the cooling fan. The cooling fan can start at any time.**

4. If you see steam or spray coming from under the hood, turn off the engine.
5. If you do not see steam or spray coming from under the hood, leave the engine on until the bar graph for the engine coolant temperature warning display on the multi-information display goes down. When it is in the middle of the normal zone, you can start driving again. If the bar graph stays in the red zone, turn off the engine.

⚠ WARNING

- **Before raising the engine hood, check to see if there is steam or spray coming from under the hood. Steam or spray coming from an overheated engine could seriously scald you. Do not open the hood until there is no steam or spray.**

6. When you do not see any more steam or spray, open the hood. Look for obvious leaks, such as a split radiator hose. Be careful as components will be hot. Any leak source must be repaired.
7. If there is no obvious leak source, check the coolant level in the engine coolant reserve tank. If there is none, or if it is too low, slowly add coolant.
8. If the engine coolant reserve tank needs coolant, you will probably also need to add coolant to the radiator. Do not loosen or remove the radiator cap until the engine has cooled down.

Jack and tools

⚠ WARNING

● Removing the radiator cap could scald you with escaping hot water or steam. When checking the radiator level, cover the cap with a cloth before trying to remove it. Turn it slowly counterclockwise, without pressing down, to the first notch. The pressure in the system will then be let out. When the pressure is COMPLETELY LET OUT, press down and keep turning the cap counterclockwise until it comes off.

9. Start the engine, and slowly add coolant, up to the bottom of the filler neck. Use plain water if you have to (and replace it with the right coolant as soon as possible).
10. Replace the radiator cap and tighten it fully. Check the engine coolant temperature display on the multi-information display. You can start driving again when the bar graph for the engine coolant temperature display returns to the normal zone.
11. Have the system inspected by your authorized Mitsubishi Motors dealer or a repair facility of your choice.

Jack and tools

N00836601448

Storage

The tools and jack are stowed in the luggage compartment.

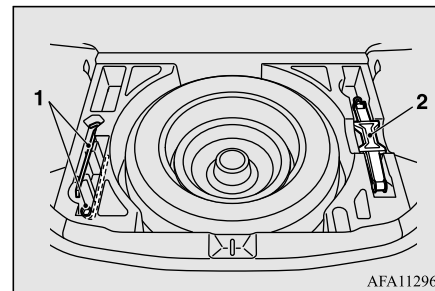

AFA112967

- 1- Tools
- 2- Jack

Tools

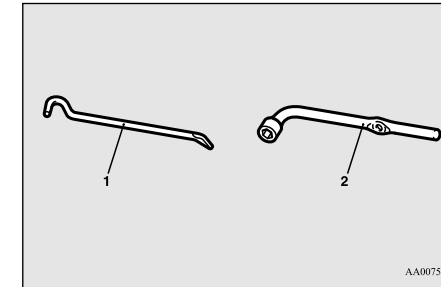

AA0075349

- 1- Bar
- 2- Wheel nut wrench

8

Jack

Before removing the jack, lift up the luggage floor board.

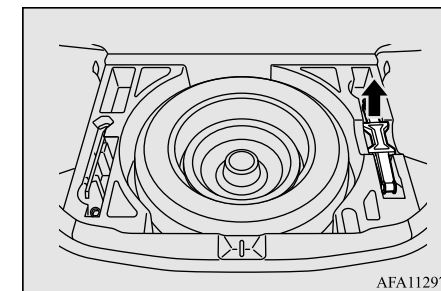

AFA112970

For emergencies 8-5

How to change a tire

How to change a tire

N00836901832

⚠ WARNING

- The jack should not be used for any purpose other than to change a tire.
- Never get under the vehicle or put any portion of your body under the vehicle while it is supported by the jack.

Before changing a tire, first stop your vehicle in a safe, flat location.

8

1. Park the vehicle on level and stable ground.
2. Set the parking brake firmly.
3. On vehicles equipped with manual trans-axle, stop the engine and move the gear-shift lever to the “R” (Reverse) position. On vehicles equipped with continuously variable transmission (CVT), move the selector lever to the “P” (PARK) position, and stop the engine.
4. Turn on the hazard flashers and set up a warning triangle, flashing signal light, etc., at an adequate distance from the vehicle, and have all your passengers leave the vehicle.

5. To prevent the vehicle from rolling when it is raised on the jack, place chocks or blocks (A) in front of and behind the tire that is diagonally opposite from the tire (B) you are changing.

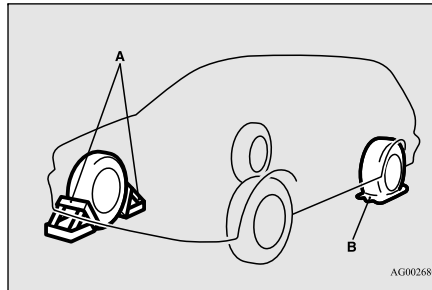

⚠ WARNING

- Be sure to apply chocks or blocks to the correct tire when jacking up the vehicle. If the vehicle moves while jacked up, the jack could slip out of position, leading to an accident.

📖 NOTE

- The chocks shown in the illustration do not come with your vehicle. It is recommended that you purchase chocks or blocks and keep them in the vehicle for use if needed.
- If chocks or blocks are not available, use stones or any other objects that are large enough to hold the wheel in position.

6. Get the jack, bar and wheel nut wrench ready. (Refer to “Jack and tools” on page 8-5.)

Spare tire information

N00849600331

Compact spare tire

The compact spare tire is stowed beneath the luggage floor board of the luggage compartment. It is designed to save space in the luggage compartment. Its lighter weight makes it easier to use if a flat tire occurs.

⚠ WARNING

- Tires, including spare tire, degrade over time with age even when they are not being used. It is recommended that tires over 6 years generally be replaced even if damage is not obvious.

⚠ CAUTION

- While the compact spare tire is stowed, the inflation pressure should be checked at least once a month to assure that it remains at the recommended inflation pressure. See the tire and loading information placard attached to the driver’s door sill. Refer to “Tire and loading information placard” on page 11-2.

How to change a tire

⚠ CAUTION

- Driving with an improperly inflated tire can cause an accident. If you have no choice but to drive with an under-inflated tire, keep your speed down and avoid sudden steering or braking, if possible. Inflate the tire to the correct pressure as soon as possible. Refer to “Tire inflation pressures” on page 9-18.
- The compact spare tire should be used only temporarily. While the compact spare tire is being used, the tire pressure monitoring system will not function properly. Have the tire replaced or repaired at an authorized Mitsubishi Motors dealer or a repair facility of your choice as soon as possible.
- Do not go over 50 mph (80 km/h) when driving with the compact spare tire.
- Avoid sudden starting and braking when driving with the compact spare tire.
- Do not drive through automatic car washes and over obstacles that could possibly damage the underside of your vehicle. Because the compact spare tire is smaller than the original tire, there is less clearance between the ground and your vehicle.
- Because the compact spare tire is designed only for your vehicle, do not use it on any other vehicle.
- Do not put the compact spare tire on a different wheel, and do not put standard tires, snow tires, wheel covers or trim rings on the compact spare wheel. Otherwise, you could damage these parts or other parts on your vehicle.

⚠ CAUTION

- Do not use tire chains with your compact spare tire. Using a chain could cause damage to your vehicle and loss of the chains.

To remove the spare tire

N00849701397

1. Lift up the luggage floor board.
2. To remove the spare tire, remove the spare tire pad (A), and then remove the installation clamp (B) by turning it counterclockwise.

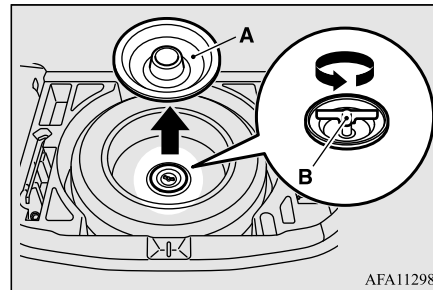

📖 NOTE

- The clamp cannot be used for a normal size tire. Store a normal size tire under the luggage floor board.

To change a tire

N00849801503

1. On vehicles with wheel covers, first remove the covers (refer to “Wheel covers” on page 8-11). Then, loosen the wheel nuts with the wheel nut wrench. Do not remove the wheel nuts yet.

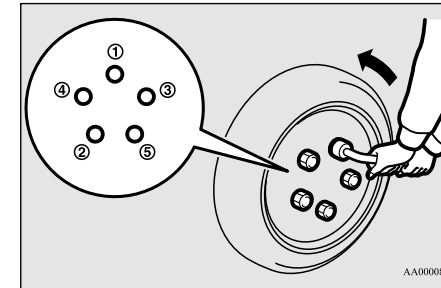

8

2. Place the jack under one of the jacking points (A) shown in the illustration. Use the jacking point closest to the tire you wish to change.

How to change a tire

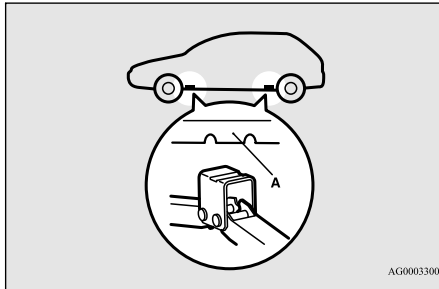

8

⚠ WARNING

- Set the jack only at the positions shown here. If the jack is set at a wrong position, it could dent your vehicle or the jack might fall over and cause personal injury.
- Do not use the jack on a tilted or soft surface. Otherwise, the jack might slip and cause personal injury. Always use the jack on a flat, hard surface. Before setting the jack, make sure there are no sand or pebbles under the jack base.

📖 NOTE

- Put the spare wheel under the vehicle body near the jack. This makes it safer if the jack slips out of position.

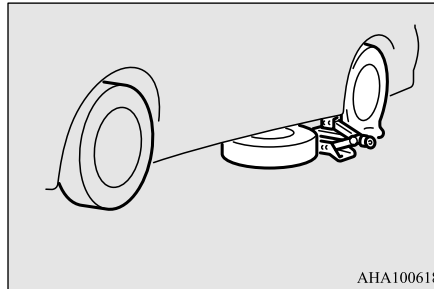

3. Rotate the jack by hand until the flange portion (B) fits in the groove (C) at the top of the jack.

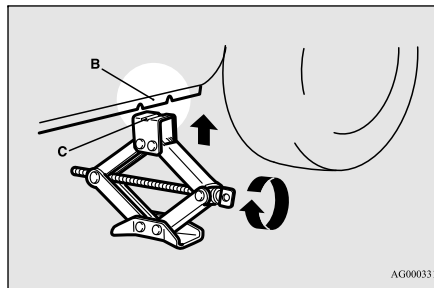

4. Make sure that the flange portion at the jacking point fits in the groove at the top of the jack. Insert the bar (D) into the wheel nut wrench (E). Then put the end of the bar into the shaft's jack end, as shown in the illustration.

Slowly rotate the wheel nut wrench until the tire is raised slightly off the ground surface.

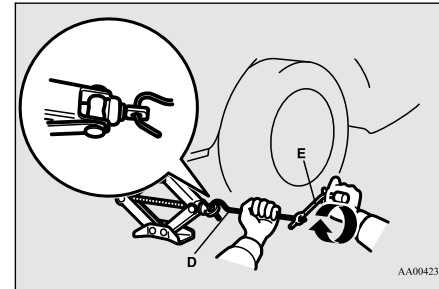

⚠ WARNING

- Stop jacking up the vehicle as soon as the tire is raised off the ground. It is dangerous to raise the vehicle any higher.
- Do not get under your vehicle while using the jack.
- Do not bump the raised vehicle or leave it sitting on the jack for a long time. Both are very dangerous.
- Do not use a jack except the one that came with your vehicle.
- The jack should not be used for any purpose other than to change a tire.
- No one should be in your vehicle when using the jack.
- Do not start or run the engine while your vehicle is on the jack.

How to change a tire

⚠ WARNING

- Do not turn the raised wheel. The tires that are still on the ground could turn and make your vehicle fall off the jack.

5. Remove the wheel nuts with the wheel nut wrench, then take the wheel off.

⚠ CAUTION

- Handle the wheel carefully when changing the tire, to avoid scratching the wheel surface.

6. Clean out any mud, etc. on the hub surface (F), hub bolts (G) or in the installation holes (H) in the wheel, and then mount the spare tire.

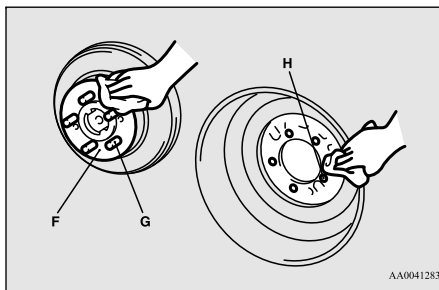

⚠ WARNING

- Mount the spare wheel with the valve stem (I) facing outward. If you cannot see the valve stem (I), you have installed the wheel backwards. Operating the vehicle with the spare wheel installed backwards can cause vehicle damage and result in an accident.

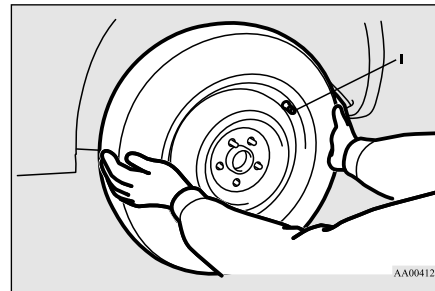

7. [Vehicle with the tapered nuts]
Install the wheel nuts with their tapered ends facing inward, then tighten by hand until the wheel is no longer loose.

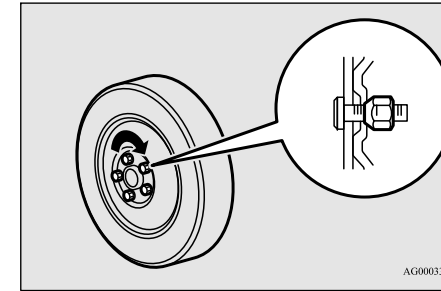

[Vehicle with the flange nuts]

- Aluminium wheel
- Temporarily tighten the wheel nuts until their flange section comes in contact with the wheel and it is no longer loose.

8

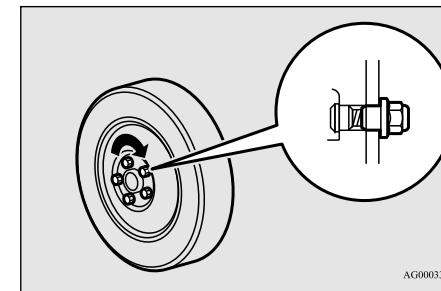

- Steel wheel
- Install the wheel nuts with their tapered ends facing inward, then tighten by hand until the wheel is no longer loose.

For emergencies 8-9

How to change a tire

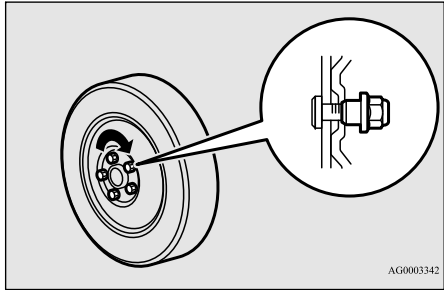

8

CAUTION

- Never apply oil to either the wheel bolts or the nuts or they will tighten too much.

NOTE

- Flange nuts can be temporarily used on the compact spare or steel wheel, but return them to the original wheel and tire as soon as possible.
- If all 4 wheels are changed to steel wheels, use tapered nuts.

8. Lower the vehicle slowly until the tire touches the ground, by rotating the wheel nut wrench counterclockwise.

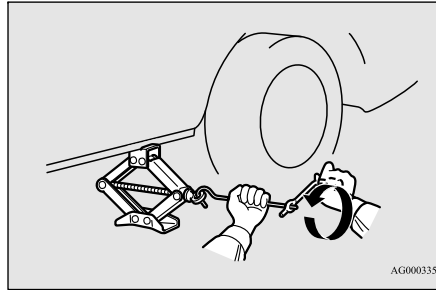

9. Tighten the nuts in the order shown in the illustration until each nut has been tightened to the torque listed here.
65 to 80 ft-lb (88 to 108 N•m)

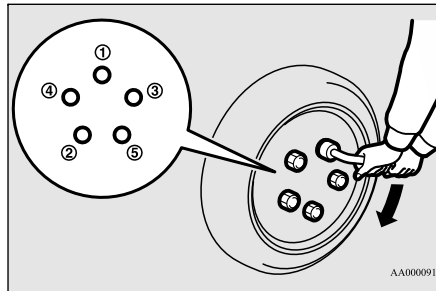

CAUTION

- Never use your foot or a pipe extension to apply added force to the wheel nut wrench when tightening the wheel nuts. If you do so, you can over-tighten the wheel nuts and damage the wheel, wheel nuts and hub bolts.

10. Lower the jack all the way and remove it.
11. Check the tire inflation pressure. The recommended tire pressure for your vehicle is listed on the tire and loading information placard attached to the driver's door sill as shown in the illustration. Refer to "Tire inflation pressures" on page 9-18.

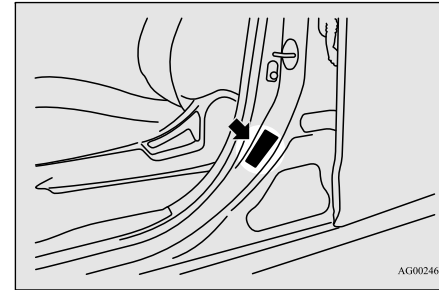

CAUTION

- Driving with an improperly inflated tire can cause an accident. If you have no choice but to drive with an under-inflated tire, keep your speed down and avoid sudden steering or braking, if possible. Inflate the tire to the correct pressure as soon as possible. Refer to "Tire inflation pressures" on page 9-18.
- After changing the tire and driving the vehicle about 620 miles (1,000 km), retighten the wheel nuts to make sure that they have not come loose.

How to change a tire

⚠ CAUTION

- If the steering wheel vibrates when driving after changing the tire, have the tire checked for balance at an authorized Mitsubishi Motors dealer or a repair facility of your choice.
- Do not mix one type of tire with another or use a different size from the one listed. This would cause early wear and poor handling.

To store the flat tire or spare tire, jack, bar and wheel nut wrench

N00850000162

Reverse the removing procedure when storing the flat tire or spare tire, jack, bar and wheel nut wrench.

Refer to “To remove the spare tire” on page 8-7 and “Jack and tools” on page 8-5.

Wheel cover (if so equipped)

N00849400195

To remove

Wrap the tip of the bar with a cloth, insert it deeply into the notch provided in the wheel cover, and pry the cover away from the wheel.

Using the same procedure at the other wheel cover notches, work the wheel cover away from the wheel to remove it completely.

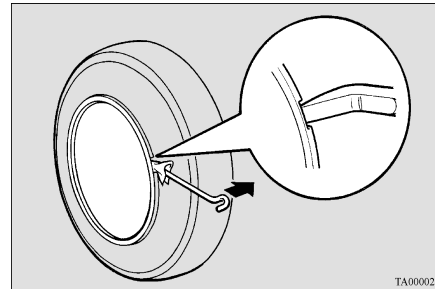

📖 NOTE

- The wheel cover is made of plastic. Be careful when prying it off.

⚠ CAUTION

- Trying to remove the wheel cover with only your bare hands can seriously injure your fingers.

To install

⚠ CAUTION

- Before installing the wheel cover to the wheel, make sure that the tabs (A) on the back of the wheel cover correctly engage the ring (B) to prevent the wheel cover from coming off. Do not install a wheel cover that has broken tabs.

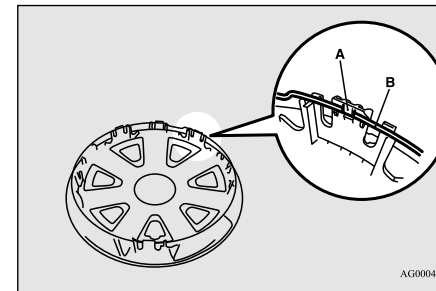

1. Align the tire air valve (C) and the wheel cover notch (D).

Towing

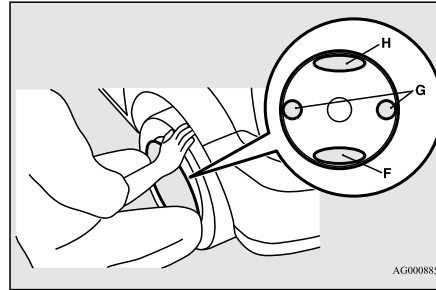
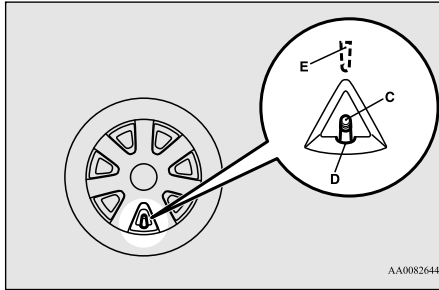

8

NOTE

- Full wheel covers have a symbol mark (E) provided on the reverse side to show the air valve location. Before installing the wheel cover to the wheel, make sure that the opening with the symbol mark is correctly aligned with the air valve.

2. Push the bottom (F) of the wheel cover into the wheel.
3. Gently push in both sides (G) of the wheel cover and hold them in place with both knees.
4. Gently tap around the circumference of the wheel cover at the top (H), then push the wheel cover into place.

Towing

N00837001986

If your vehicle needs to be towed

If towing is necessary, we recommend you to have it done by a commercial tow truck service.

When towing is required, transport the vehicle using a tow truck.

Incorrect towing equipment could damage your vehicle.

CAUTION

- Do not attempt to be towed by another vehicle with a rope.

NOTE

- Do not use the tie-down hooks for towing. These hooks are provided only for the purpose of transporting the vehicle itself.
- Your vehicle cannot tow any other vehicle.

There may be local regulations concerning towing in your area.

Obey the regulations of the area where you are driving your vehicle.

A



Do not tow all-wheel drive vehicles or CVT vehicles with this style.

B



c Do not tow all-wheel drive vehicles with this style.



D



E



AFG100089

Towing the vehicle by a tow truck

⚠ CAUTION

- This vehicle must not be towed by a tow truck using sling lift type equipment (Type A) as illustrated. Using a sling lift will damage the bumper and front end.
- Do not tow all-wheel drive vehicles with the front or rear wheels on the ground (Type B or Type C) as illustrated. This could result in the driving system damage or vehicle may jump at the carriage.
If you tow all-wheel drive vehicles, use only Type D or E equipment.
All-wheel-drive vehicles cannot be towed with only the front or rear tires on the ground even if it is in “2WD” drive mode.
- Do not tow continuously variable transmission (CVT) vehicles with the driving wheels on the ground (Type B) as illustrated. If the vehicle is towed like this, the continuously variable transmission (CVT) fluid may not reach all parts of the transmission, thus damaging it.
If you tow CVT vehicles, use Type C, D or E equipment.
- If the manual transaxle is malfunctioning or damaged, transport the vehicle with the driving wheels on a carriage (Type C, D or E) as illustrated.

⚠ CAUTION

- [For front-wheel drive vehicle equipped with the active stability control (ASC)]
If the vehicle is towed with the ignition switch in the “ON” position or the operation mode in ON and only the front wheels or only the rear wheels raised off the ground (Type B or C), the ASC may operate, resulting in an accident. When towing the vehicle with the rear wheels raised, turn the ignition switch to “OFF” or “ACC” position or put the operation mode in OFF or ACC. When towing the vehicle with the front wheels raised, keep the ignition switch or the operation mode as follows.
[Except for vehicles equipped with the F.A.S.T.-key]
The ignition switch is in “OFF” or “ACC” position.
[Vehicles equipped with the F.A.S.T.-key]
The operation mode is in OFF or ACC.

8

Towing with rear wheels off the ground (Type B)

Set the gearshift lever to the “N” (Neutral) position.
Secure the steering wheel in a straight-ahead position with a rope or tie-down strap.



Operation under adverse driving conditions

Towing a front-wheel drive vehicle with front wheels off the ground (Type C)

Release the parking brake.

Place the gearshift lever in the “N” (Neutral) position (manual transaxle) or the selector lever in the “N” (NEUTRAL) position (CVT).

8

Operation under adverse driving conditions

N00837200675

If your vehicle becomes stuck in sand, mud or snow

If your vehicle becomes stuck in snow, sand, or mud, it can often be moved by a rocking motion. Rock your vehicle back and forth to free it.

Do not rev the engine or spin the wheels. Constant efforts to free a stuck vehicle can cause overheating and transaxle failure. Let the engine idle for a few minutes to cool the transaxle before trying again.

If your vehicle is still stuck after several rocking attempts, call for help.

8-14 For emergencies



WARNING

- When trying to rock your vehicle out of a stuck position, make sure that there are no people nearby. The rocking motion can make your vehicle suddenly lurch forward or backward, and injure any bystanders.

On wet roads

CAUTION

- Avoid flooded roads. Water is often deeper than it looks, and you could be seriously hurt by driving into flood water.
- When driving in rain, on water-covered roads, or through a car wash, water could get into the brake discs and make them fail temporarily. In such cases, lightly press the brake pedal to see if they are working properly. If they are not, press the pedal lightly several times while driving to dry the brake pads or linings, then check them again.
- When driving in rain, a layer of water may form between the tires and the road surface (hydroplaning). This loosens your tires' grip on the road, making it difficult to steer or brake properly. When driving on a wet road:
 - Drive your vehicle at a safe speed.
 - Do not drive on worn tires.
 - Always keep the tires at the correct inflation pressures.

On snowy or icy roads

- When driving on a road covered with snow or ice, use snow tires. Tire chains cannot be used on your vehicle. There may be state or local regulations about using snow tires. Always check the regulations in your local area before using them. Refer to “Snow tires” on page 9-20 and “Tire chains” on page 9-21.
- Drive slowly. Do not make sudden starts or stops, sharp turns, or slam on the brakes.
- Allow extra distance between your vehicle and the vehicle in front of you, and avoid sudden braking.
- If a skid occurs when the accelerator pedal is depressed, take your foot off the pedal. Steer gently in the direction of the skid.
- Your vehicle is equipped with an anti-lock braking system (ABS). Hold the brake pedal down firmly and keep it depressed. Do not pump the brake pedal which will result in reduced braking performance.
- After parking on snowy or icy road, it may be difficult to move your vehicle due to freeze-up of the brake. Depress the accelerator pedal little by little to move the vehicle after confirming safety of the vehicle.

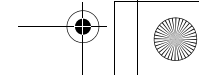
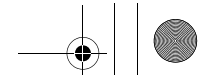

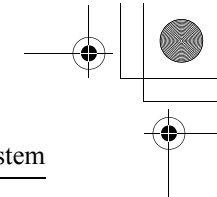

Fuel Pump Shut-off System

CAUTION

- Do not depress the accelerator pedal rapidly. The vehicle could start moving when it breaks free from the ice, possibly resulting in an accident.

WARNING

- **Mitsubishi Motors recommends that your vehicle be inspected by an authorized Mitsubishi Motors dealer after any collision.**

On a bumpy or rutted road

- Drive as slow as possible when driving on bumpy, rutted roads or over potholes.

In the event of a collision causing frontal air-bag deployment, the fuel pump shut-off system will activate to stop fuel supply to the engine.

CAUTION

- Driving on bumpy, rutted roads or over potholes can damage the tires and wheels. Wheels with low-profile tires or under-inflated tires are especially at risk for damage.

8

Fuel Pump Shut-off System

N00860600028

WARNING

- **Before attempting to restart the engine after a collision, always inspect the ground under the vehicle for leaking fuel. If a fuel leak is found or a fuel odor is detected, do not restart the engine.**

For emergencies 8-15

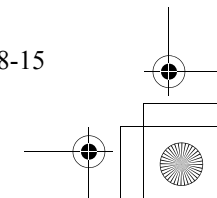
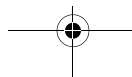
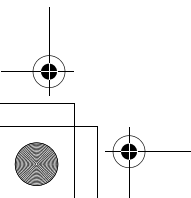

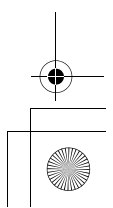
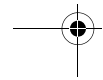
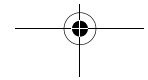
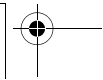
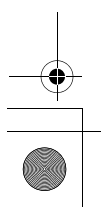
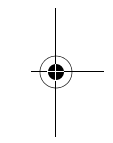
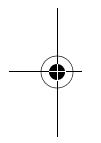
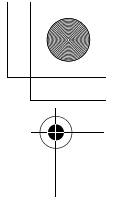
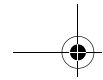
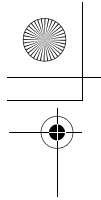

Handwriting practice area consisting of ten horizontal dashed lines.

Vehicle care and maintenance

Service precautions	9-2	Cleaning the outside of your vehicle	9-41
Catalytic converter	9-2		
Engine hood	9-3		
View of the engine compartment	9-5		
Engine oil and oil filter	9-5		
Engine coolant	9-7		
Air cleaner filter	9-8		
Manual transaxle oil (if so equipped)	9-9		
Continuously variable transmission (CVT) fluid (if so equipped)	9-9		
Transfer oil (All-wheel drive models)	9-9		
Rear axle oil (All-wheel drive models)	9-10		
Washer fluid	9-10		
Brake fluid/Clutch fluid (if so equipped)	9-10		
Battery	9-11		
Tires	9-14		
Clutch pedal free play (if so equipped)	9-21		
Brake pedal free play	9-21		
Parking brake	9-21		
Wiper blades	9-22		
Emission-control system maintenance	9-22		
General maintenance	9-23		
For cold and snowy weather	9-24		
Fusible links	9-25		
Fuses	9-25		
Replacement of light bulbs	9-29		
Vehicle care precautions	9-39		
Cleaning the inside of your vehicle	9-40		

Service precautions

Service precautions

N00937301427

Taking regular care of your vehicle will preserve its value and appearance as long as possible.

You can do some of the maintenance work yourself, and the rest should only be performed by an authorized Mitsubishi Motors dealer or a repair facility of your choice.

If you discover a malfunction or other problem, have it corrected by an authorized Mitsubishi Motors dealer or a repair facility of your choice.

9

This section describes the maintenance inspections that you can do yourself, if you so desire. Follow the instructions and precautions for each procedure.

WARNING

- When checking or servicing the inside of the engine compartment, be sure the engine is stopped and has had a chance to cool down.
- If you need to work in the engine compartment with the engine running, be especially careful that your clothing, hair, etc. does not get caught in the fan, drive belts, or other moving parts.

WARNING

- After performing the maintenance work, make sure that no tools or cloths are left behind in the engine compartment. If they are left behind, a fire or damage to the vehicle may occur.
- The fan can turn on automatically even if the engine is not running. Turn the ignition switch to the "OFF" position or put the operation mode in OFF to be safe while you work in the engine compartment.
- Do not smoke or allow open flames around fuel or the battery. The fumes are flammable.
- Be extremely careful when working around the battery. It contains poisonous and corrosive sulfuric acid.
- Do not get under your vehicle while it is on a jack. Always use properly rated automotive jack stands.
- Handling your vehicle's parts and materials in the wrong way can injure you. Ask an authorized Mitsubishi Motors dealer or a repair facility of your choice if you have questions.



DIAMOND CARE PROTECTION PLAN

Have you purchased the Mitsubishi Motors Diamond Care Protection Plan? The Plan supplements your new vehicle warranties. See your authorized Mitsubishi Motors dealer for details.

Catalytic converter

N00937400447

The catalytic converter requires you to use unleaded fuel only. Leaded gasoline will destroy the emission-control effectiveness of the converter.

Normally, the catalytic converter does not require maintenance. However, it is important to keep the engine properly tuned for the converter to continue to work properly.

Engine hood

⚠ CAUTION

- Damage to the catalytic converter can result if your vehicle is not kept in proper operating condition. If the engine malfunctions or misfires, or if your vehicle performance suffers, have it serviced promptly. Running your vehicle when it is overheated may result in damage to the converter and vehicle.

⚠ WARNING

- **Do not park or run your vehicle in areas where combustible materials such as dry grass or leaves can come in contact with a hot exhaust, since a fire could occur.**
- **Do not put undercoat paint on the catalytic converter.**

To reduce the possibility of catalytic converter damage:

- Use **UNLEADED GASOLINE ONLY** of the type of recommended in “Fuel selection”.
- Do not drive with an extremely low fuel level. Running out of gas could damage the catalytic converter.
- Do not try to start the engine by pushing or towing the vehicle. If the battery is weak or run down, use jumper cables to properly start the engine.

- Do not idle the engine with any spark plug wires disconnected or removed, such as when performing diagnostic tests.
- Do not idle the engine for a long time if it is idling roughly or otherwise obviously malfunctioning.
- To prevent the catalytic converter from being damaged from unburned gas, do not race the engine when stopping the engine.
- Stop driving the vehicle if you think the performance is noticeably low, or the engine has a malfunction such as with the ignition, etc. If you are not able to stop driving immediately, slow down and drive for only a short time. Have your vehicle checked at an authorized Mitsubishi Motors dealer or a repair facility of your choice as soon as possible.
- In unusual situations involving major engine problems, a burning odor may indicate severe and abnormal catalytic converter overheating. If this occurs, stop in a safe place, shut the engine off and let the vehicle cool. Once the engine is cool, immediately take your vehicle to a dealer or a repair facility of your choice for service.

Engine hood

N00937501618

To open

Use the engine hood release lever (located under the instrument panel near the driver's door) to unlock the engine hood.

Pull the lever toward you to release the engine hood latch.

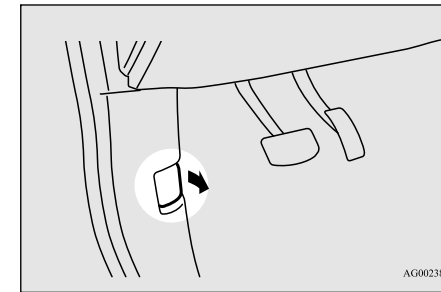

9

⚠ WARNING

- **Never use the release lever to unlatch the engine hood while the vehicle is in motion.**
- **Do not drive your vehicle unless the engine hood is locked.**

Engine hood

Release the lever and lift the engine hood.

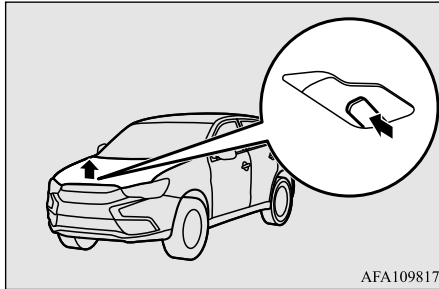

NOTE

- To prevent damage to the engine hood and wipers, make sure the wipers are at resting position when you open the engine hood.

Support the engine hood with the hood prop. Insert the hood prop securely in the opening under the hood marked with an arrow.

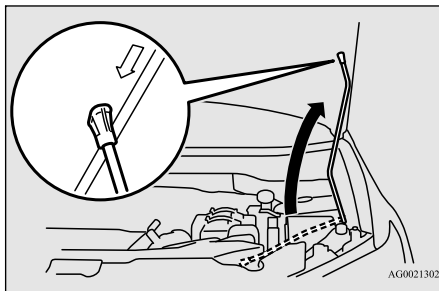

CAUTION

- Always insert the support prop into the hole specially made for it. Propping the engine hood at any other place could cause the prop to slip out and lead to an accident.
- The hood prop can fall out if the hood is lifted by a strong wind.

To close

Unlatch the prop from the engine hood and put it back in its retainer.

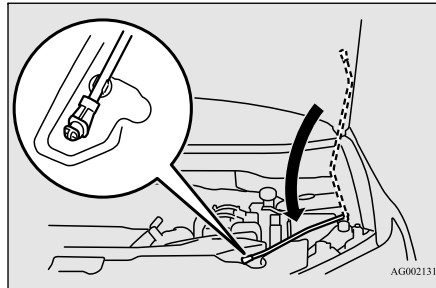

Slowly lower the engine hood about 8 inches (20 cm), then let it drop from its own weight.

CAUTION

- Be careful not to trap your hands or fingers when closing the engine hood.

CAUTION

- Make sure the engine hood is firmly closed before driving. If you drive without the engine hood completely closed, it could open up while driving.

NOTE

- If this does not close the engine hood properly, drop it again from a slightly higher position.
- Do not push down strongly on the engine hood. Depending on how strongly or where you push down, you could create a dent in the vehicle body.
- If you drive with the engine hood left open, warning display is displayed on the information screen in the multi-information display.



Type 2



View of the engine compartment

N00937600625

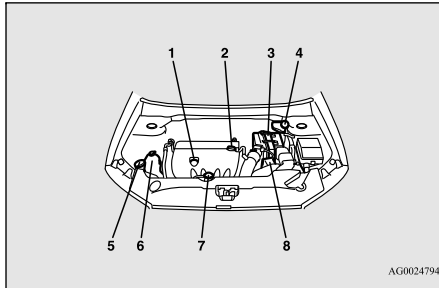

AG0024794

- 1- Engine oil level dipstick
- 2- Engine oil filler cap
- 3- Air cleaner filter
- 4- Brake fluid/Clutch fluid reservoir (if so equipped)
- 5- Windshield and rear window washer fluid reservoir
- 6- Engine coolant reserve tank
- 7- Radiator cap
- 8- Battery

Engine oil and oil filter

N00937702053

To check and refill engine oil

It is normal for an engine to use oil. You may need to add oil between the recommended oil change intervals. Before starting the engine, check the engine oil level. Refill if necessary.

To check the oil level, remove the dipstick, wipe it off, and gently reinsert it all the way. Slowly pull the dipstick straight out and check the oil level by checking the upper surface of the dipstick. The oil level must not go above the line on the dipstick.

NOTE

- If it is difficult to verify the oil level, wipe off the dipstick and reinsert it. Wait a moment and then recheck the oil level by checking the upper surface of the dipstick.

If the level does not reach the line which shows the smallest amount of oil required, remove the oil filler cap on the engine valve cover, and fill to within the “Good” range.

View of the engine compartment

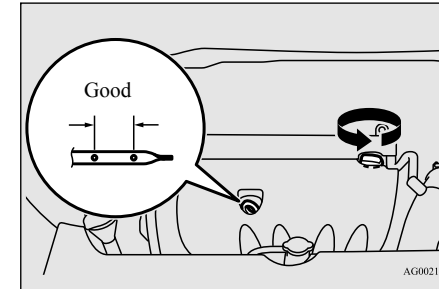

AG0021328

CAUTION

- Overfilling will cause oil aeration and loss of oil pressure, which could damage the engine.

WARNING

- Used engine oil is poisonous, and can damage your skin. Prolonged and repeated contact may cause serious skin disorders, including dermatitis and cancer. Do not let used oil touch your skin and wash thoroughly after working with it.
- Keep used oil out of the reach of children.

NOTE

- Engine oil consumption is greatly influenced by payload, engine speed, etc.

Engine oil and oil filter

NOTE

- The engine oil will deteriorate rapidly if the vehicle is subjected to severe conditions (for example, repeated operation on rough roads, in mountainous regions, on roads with many uphill and downhill gradients, or over short distances). Consequently, the oil will require earlier replacement in accordance with the schedule in the “WARRANTY AND MAINTENANCE MANUAL”.

Engine oil identification mark

9

Mitsubishi Motors recommends using only engine oils with the ILSAC certification symbol on the front of the container.

ILSAC certification symbol



AHA100692

If you cannot find oils with the ILSAC certification symbol, use an API classification SN or higher oil with the following label.

This mark appears on the top of the oil container and tells you two important things about the oil.

API service symbol

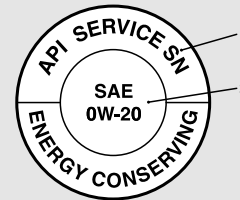

AH0000849

- 1- The upper part indicates the quality of the oil.
- 2- The center part indicates the SAE grade of the oil viscosity.

Recommended engine oil viscosity

Use engine oil with the proper thickness for the outdoor temperatures where you will be driving.

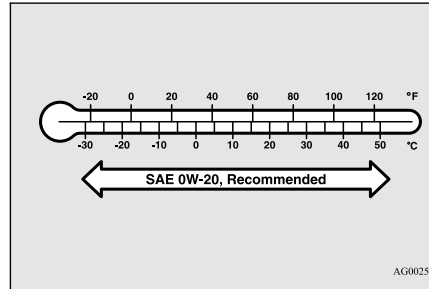

AG0025603

Mitsubishi Motors Genuine 0W-20 Synthetic Engine Oil is recommended for optimum fuel economy and cold weather starting.

If Mitsubishi Motors Genuine 0W-20 Synthetic Engine Oil is not available, 5W-20 grade oils displaying the ILSAC certification can be used. However, Mitsubishi Motors Genuine 0W-20 Synthetic Engine Oil should be used at the next oil change to maintain optimum fuel economy and cold weather starting.

To replace the oil filter

The oil filter should be replaced at the time or mileage specified in the “WARRANTY AND MAINTENANCE MANUAL”.

Only use high quality replacement filters on this vehicle. The manufacturer’s specifications for Genuine Mitsubishi oil filters

require that the filter can withstand a pressure of 256 psi (1.8 MPa). A Genuine Mitsubishi oil filter is the best replacement filter.

Follow the installation instructions printed on the filter.

Engine coolant

N00937800584

To check the coolant level

The engine coolant reserve tank (A) lets you quickly see when you need to add coolant. When the engine is cold, the level of the coolant in the reserve tank should be between the FULL and LOW marks. The radiator usually stays full so there is no reason to remove the radiator cap (B) except when you check the coolant freeze point or replace the antifreeze coolant.

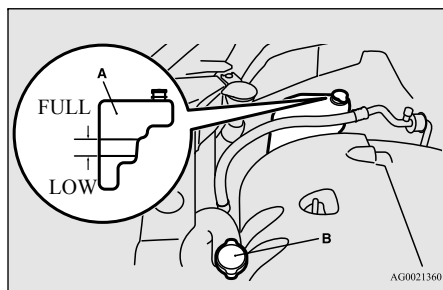

AG0021360

To add coolant

Use “Mitsubishi Motors Genuine Super Long Life Coolant Premium” or equivalent*.

*:similar high quality ethylene glycol based non-silicate, non-amine, non-nitrate and non-borate coolant with long life hybrid organic acid technology

Mitsubishi Motors Genuine Coolant provides excellent protection against corrosion and rust formation on all metals, including aluminum, and prevents clogs in some parts of the engine.

If you need to add coolant often, or if the level in the reserve tank does not drop when the engine cools, the cooling system should be pressure-tested for leaks. Take your vehicle to an authorized Mitsubishi Motors dealer or a repair facility of your choice for testing.

CAUTION

- Do not use alcohol or methanol antifreeze or any engine coolants that contain them. Using the wrong antifreeze can corrode aluminum parts.

CAUTION

- The required concentration of anti-freeze differs depending on the expected ambient temperature.

Above -31 °F (-35 °C) : 50 % concentration of anti-freeze

Below -31 °F (-35 °C) : 60 % concentration of anti-freeze

You can check the concentration level with a gauge from an automotive supply store, or your authorized Mitsubishi Motors dealer or service station can check it for you.

- Do not use water to adjust the concentration of coolant.
- Do not top off the tank with plain water only. Water by itself boils at a lower temperature and does not stop rust or freezing. If the water freezes, it will damage your cooling system. Do not use tapwater. It can cause corrosion and rust.

9

Radiator cap

The radiator cap must be tight sealed to prevent losing coolant, which may result in engine damage. Only use a Genuine Mitsubishi Parts radiator cap, or an approved equivalent.

Air cleaner filter

⚠ WARNING

- Wait for the engine to cool down before opening the radiator cap. Otherwise hot steam or boiling coolant could spray up from the radiator and scald you.

Points to remember

- Do not overfill the reserve tank.
- Your vehicle uses a special radiator cap that stays sealed and lets the coolant flow from the reserve tank back to the radiator when the engine cools down. If you need to change the cap, use the exact same kind.
- Check the coolant freeze point in the radiator with the proper gauge, and only when it is safe. If you add antifreeze, the contents of the reserve tank must be protected against freezing.
- Keep the front of the radiator and condenser clean.
- If the engine coolant temperature does not rise after the engine is warmed-up, take your vehicle to an authorized Mitsubishi Motors dealer or a repair facility of your choice to have the thermostat checked, and replaced if necessary.

9

Air cleaner filter

N00937901537

The air cleaner filter will get dirty and dusty from use and not filter properly. Replace it with a new filter using the schedule in the “WARRANTY AND MAINTENANCE MANUAL”.

1. Remove the upper cover and duct. For details, refer to “Removing and installing the upper cover and duct” on page 9-11.
2. While holding down the tab (A), pull out the connector (B).

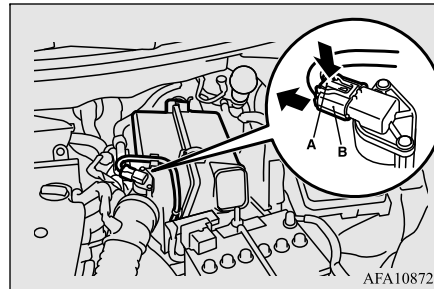

AFA108722

3. Unclamp the cover. Open up the top of the cover and take out the air cleaner filter.

Type 1

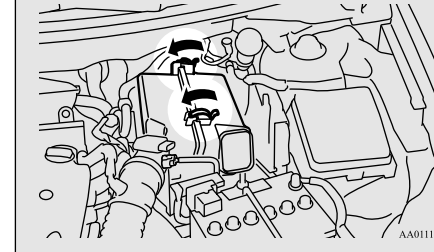

AA011953

Type 2

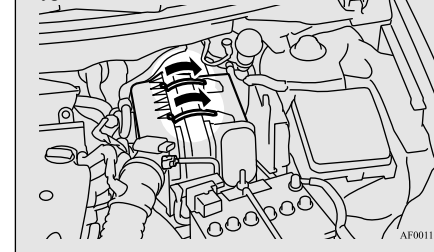

AF0011625

4. Replacing the air cleaner filter and put the cover back on in its original position.

NOTE

- Genuine Mitsubishi Motors Parts are recommended when replacing the air cleaner filter.
- Make sure that the connector is properly reconnected.

NOTE

- After replacing the air cleaner filter, make sure that the hinges at the bottom of cover are firmly set.

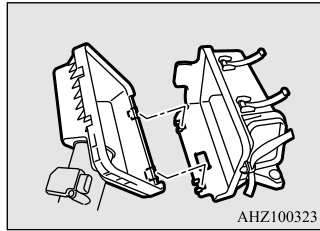

CAUTION

- Take care not to scratch the engine air flow sensor when removing the air cleaner cover.

5. Put the duct and upper cover back on in its original position. For details, refer to “Removing and installing the upper cover and duct” on page 9-11.

Manual transaxle oil (if so equipped)

N00938201191

Whenever the manual transaxle oil level is checked, add oil to maintain the proper level, if necessary. Refill or change the oil according to the table.

Oil type

Lubricant	Mitsubishi Motors Genuine NEW MULTI GEAR OIL ECO API GL-4 or Mitsubishi Motors Genuine NEW MULTI GEAR OIL API GL-3
Viscosity range	SAE 75W-80

Continuously variable transmission (CVT) fluid (if so equipped)

N00938101099

The continuously variable transmission (CVT) should be maintained and serviced by an authorized Mitsubishi Motors dealer or a repair facility of your choice to obtain the best performance and longest life. It is important that the transmission fluid is kept at the correct level.

Fluid type

Use only “Mitsubishi Motors Genuine CVTF-J4” transmission fluid to ensure optimum transmission performance.

Manual transaxle oil (if so equipped)

CAUTION

- Using the improper transmission fluid may damage the transaxle.

Special additives

Do not use any fluid additives to the transmission.

Transfer oil (All-wheel drive models)

N00938401294

9

Whenever the transfer oil level is checked, add oil as necessary to maintain the proper level. Fill or change the oil according to the table.

Fluid type

Lubricant	Mitsubishi Motors Genuine Super Hypoid Gear Oil API GL-5
Viscosity range	SAE 80

Rear axle oil (All-wheel drive models)

Rear axle oil (All-wheel drive models)

N00915201282

Whenever the oil level is checked, add oil as necessary to maintain the proper level. Fill or change oil according to the table.

Fluid type

Lubricant	Mitsubishi Motors Genuine Super Hypoid Gear Oil API GL-5
Viscosity range	SAE 80

9

Washer fluid

N00938601355

The windshield and rear window washer fluid reservoir is in the engine compartment.

Check the washer fluid level at regular intervals and add washer fluid to reservoir if necessary. Open the reservoir cap and check the fluid level with the dipstick.

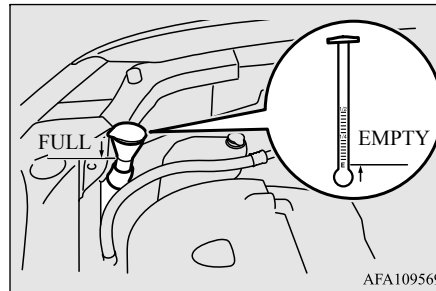

When freezing weather is anticipated, flush out the water in the reservoir by operating the pump. Fill the reservoir with windshield anti-freeze (not radiator antifreeze), and operate the system for a few seconds to flush out the residual water.

Brake fluid/Clutch fluid (if so equipped)

N00938701330

The brake fluid and the clutch fluid share the reservoir tank.

To check the fluid level

The fluid level must be between the “MAX” and “MIN” marks on the reservoir.

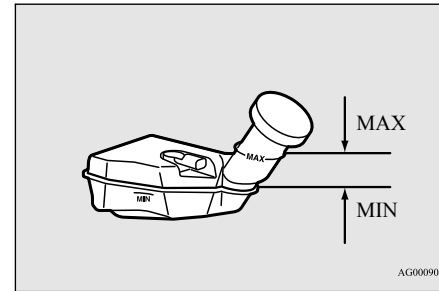

The fluid level falls slightly with wear of the brake pads, but this does not indicate any abnormality.

The fluid in the master cylinder should be checked when doing other work under the engine hood. The brake system should also be checked for leaks at the same time.

If the fluid level falls markedly in a short length of time, it indicates leaks from the brake system.

If this occurs, have the vehicle checked by an authorized Mitsubishi Motors dealer or a repair facility of your choice.

Battery

Fluid type

Use the brake fluid conforming to DOT 3 or DOT 4. The reservoir cap must be tightly sealed to keep dirt and water out.

WARNING

- Take care in handling brake fluid as it is harmful to the eyes, may irritates your skin and will damage painted surfaces. Wipe up spills immediately. If brake fluid gets on your hands or in your eyes, flush immediately with clean water. Follow up with a doctor as necessary.

CAUTION

- Do not let any petroleum-based fluid touch, mix with, or get into the brake fluid. This will damage the seals.
- Be careful when handling brake fluid. It can damage painted surfaces.
- Use only the listed brake fluid. Different brands of brake fluid have different additives, and these can cause a chemical reaction. Do not mix brands of brake fluid.
- Keep the reservoir tank cap closed to keep the brake fluid from evaporating.

Battery

N00939101966

The condition of the battery is very important for quick starting and to keep the vehicle's electrical system working properly. Check the battery regularly.

If battery performance is suspect, have the battery and charging system tested by an authorized Mitsubishi Motors dealer or a repair facility of your choice.

NOTE

- After replacing the battery, the electronic control system data for the automatic trans-axle, etc., will be erased. As a result, shifting may be rough. Shifting will become smoother after several changes in speed.

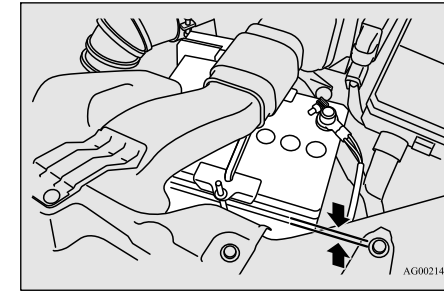
Checking battery electrolyte level

The electrolyte level must be between the limits shown on the outside of the battery. Fill it with distilled water as needed. The inside of the battery is divided into several compartments. Take the cap off of each compartment and fill to the mark.

Do not fill above the top line because a spill during driving could cause damage.

Removing and installing the upper cover and duct

N00901301064

To replenish with the distilled water, remove the upper cover and duct.

Battery

⚠ WARNING

- Turn the ignition switch to the “LOCK” position or put the operation mode in OFF.
Make sure that your clothes cannot be caught by the fan or drive belt. Personal injury could result.

To remove

1. Remove the clips (A), and then remove the upper cover (B).

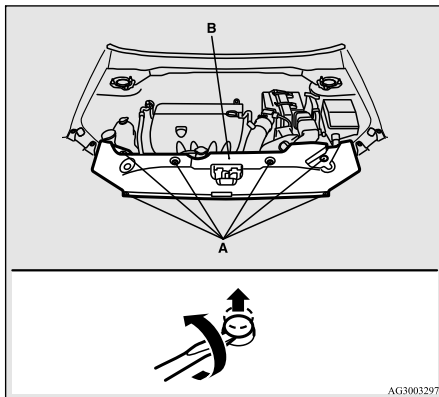

2. Remove the clips (C), and then remove the air duct (D).



To install

1. Install the air duct (A), and then tighten the clips (B).

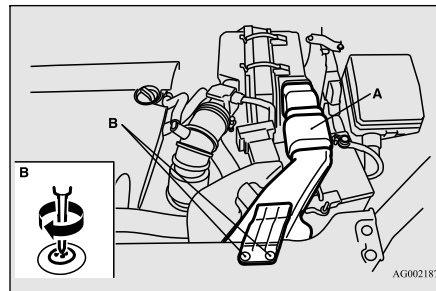

2. Turn the upper cover over. Squeeze the head of the moulding clip (C) with pliers and remove the moulding.

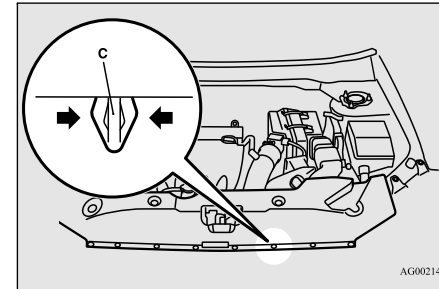

3. Install the upper cover, and then attach the moulding (D).

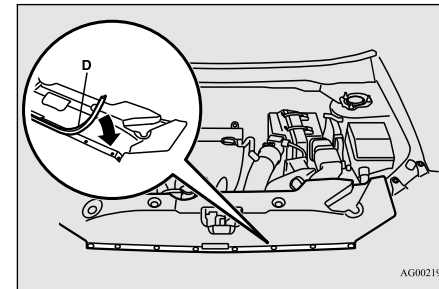

NOTE

- Attach the moulding with the wide part toward the front of the vehicle.

4. Install the clips (E).

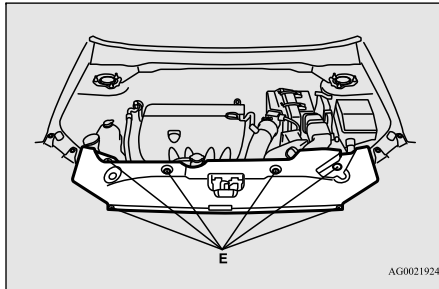

AG0021924

During cold weather

N00901600031

The battery is weaker in cold temperatures. This has to do with its chemical and physical properties and is why a very cold battery, especially one with a low charge, will have a hard time starting your vehicle.

It is recommended that you have your battery and charging system checked by an authorized Mitsubishi Motors dealer or a repair facility of your choice before the start of cold weather. If necessary, have it charged. This will guarantee more reliable starting, and longer battery life.

Disconnection and connection

N00901701156

To disconnect the battery cable, stop the engine. Disconnect the negative (-) terminal

first, then the positive (+) terminal. To reconnect the battery, first connect the positive (+) terminal and then the negative (-) terminal, before starting the vehicle.

NOTE

- Open the terminal cover (A) before disconnecting or connecting the positive (+) terminal of the battery.
- Loosen the nut (B) and then disconnect the battery cable from the positive (+) terminal.

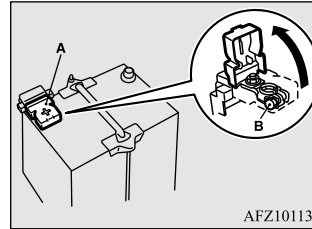

AFZ101135

WARNING

- Never disconnect the battery while the engine is running, or you could damage the vehicle's electrical parts.
- Never short-circuit the battery. This could cause it to overheat and be damaged.
- Keep sparks, cigarettes, and flames away from the battery because the battery could explode.

WARNING

- Electrolyte (battery acid) is made of corrosive diluted sulfuric acid. If it spills on nearby parts, it can crack, stain, or discolor them. And if it gets on your skin or in your eyes, it can cause burns or blindness. Please observe the following handling instructions:
 - If electrolyte gets on plastic parts or other nearby parts, wipe it off with a soft cloth or chamois soaked in a solution of water and neutral detergent then immediately rinse the affected parts with plenty of water.
 - If electrolyte gets on your hands or clothes, rinse thoroughly with water. If electrolyte gets in your eyes, flush them with water immediately and get immediate medical attention.
- Open doors and windows in any closed space where you may be charging or working with the battery.
- Always wear protective clothing and goggles when working with the battery, or have a skilled automobile technician do it.
- If you are quick-charging your battery, first disconnect the battery cables.
- In order to prevent a short-circuit, be sure to disconnect the negative (-) terminal first, and reconnect it last.
- If the electrolyte level is very low, have the battery checked at an authorized Mitsubishi Motors dealer or a repair facility of your choice.

Tires

WARNING

- **Battery posts, terminals and related accessories contain lead and lead compounds. Wash hands after handling.**

NOTE

- Check each battery terminal for corrosion. You can stop more corrosion by washing with a solution of baking soda and water. Grease the posts and clamps after cleaning or tightening them.
- Check to see that the battery is securely installed and cannot be moved. Also check each terminal for tightness.
- If you will not be driving your vehicle for a long period of time, remove the battery and store it in a place where the battery fluid will not freeze. The battery only should be stored with a full charge.
- Before cleaning the battery, tighten all the filler port caps to keep dirt and moisture out.

9

Tires

N00939201592

WARNING

- **Driving with tires that are worn, damaged or improperly inflated is dangerous. These type tire conditions will adversely affect vehicle performance. These type tire conditions can also cause a tread separation or blowout which may result in an accident causing serious injury or death.**
- **Tires, including spare tire, degrade over time with age even when they are not being used. It is recommended that tires over 6 years generally be replaced even if damage is not obvious.**

It is important to familiarize yourself with the following terms:

- **Cold tire pressure:**
 - The measured pressure after the vehicle has been parked for at least three hours, or
 - The measured pressure when the vehicle is driven less than 1 mile (1.6 km) after having been parked for three hours.
- **Maximum pressure:** the maximum permissible cold tire inflation pressure for this tire.
- **Recommended inflation pressure:** the inflation pressure for optimum tire performance.
- **Intended outboard sidewall:**
 - The sidewall that contains a whitewall, bears white lettering or bears manufacturer, brand, and/or model name molding that is higher or deeper than the same molding on the other sidewall of the tire, or
 - The outward facing sidewall of an asymmetrical tire that has a particular side that must always face outward when mounted on a vehicle.
- **Passenger car tire:** a tire intended for use on passenger cars, multipurpose passenger vehicles, and trucks, that have a gross vehicle weight rating (GVWR) of 10,000 pounds or less.
- **Light truck (LT) tire:** a tire designated by its manufacturer as primarily intended for use on lightweight trucks or multipurpose passenger vehicles.
- **Tread:** portion of a tire that comes into contact with the road.
- **Tread rib:** a tread section running circumferentially around a tire.
- **Tread separation:** pulling away of the tread from the tire carcass.
- **Carcass:** the tire structure, except tread and sidewall rubber which, when inflated, bears the load.

- Sidewall: portion of a tire between the tread and bead.
- Section width: the linear distance between the exteriors of the sidewalls of an inflated tire, excluding elevations due to labeling, decoration, or protective bands.
- Bead: the part of the tire that is made of steel wires, wrapped or reinforced by ply cords and that is shaped to fit the rim.
- Ply: a layer of rubber-coated parallel cords.
- Cord: the strands forming the plies in the tire.
- Rim: a metal support for a tire or a tire and tube assembly upon which the tire beads are seated.
- Rim diameter: nominal diameter of the bead seat.
- Groove: the space between two adjacent tread ribs.

Tire Markings

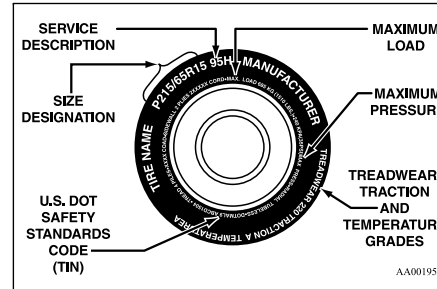

Size Designation

EXAMPLE: P215/65R15

P	Passenger car tire size based on U.S.A. design standards
215	Section width in millimeters (mm)
65	Aspect ratio in percent (%) Ratio of section height to section width of tire.

R	Construction code •“R” means radial construction. •“D” means diagonal or bias construction.
15	Rim diameter in inches (in)

NOTE

- European/Japanese metric tire sizing is based on European/Japanese design standards. Tires designed to these standards have the tire size molded into the sidewall beginning with the section width. The letter “P” is absent from this tire size designation. Example: 215/65R15 96H.

Tires

 **NOTE**

- LT (Light Truck) -metric tire sizing is based on U.S.A. design standards. The size designation for LT-metric tires is the same as for P-metric tires except for the letters “LT” that are molded into the sidewall preceding the size designation. Example: LT235/85R16.
- Temporary spare tires are high pressure compact spares designed for temporary emergency use only. Tires designed to this standard have the letter “T” molded into the sidewall preceding the size designation. Example: T145/80D18 103M.

9

Service Description

EXAMPLE: 95H

95	Load index A numerical code associated with the maximum load a tire can carry.
----	---

H	Speed symbol A symbol indicating the range of speeds at which a tire can carry a load corresponding to its load index under certain operating conditions. The maximum speed corresponding to the speed symbol should only be achieved under specified operating conditions. (i.e. tire pressure, vehicle loading, road conditions and posted speed limits)
---	--

Maximum Load

Maximum load indicates the maximum load this tire is designed to carry.

 **WARNING**

- **Overloading of your tire is dangerous. Overloading can cause tire failure, affect vehicle handling, and increase your stopping distance. Use tires of the recommended load capacity for your vehicle. Never overload them.**

Maximum Pressure

Maximum Pressure indicates the maximum permissible cold tire inflation pressure for this tire.

Tire Identification Number (TIN)

The TIN may be found on one or both sides of the tire but the date code may only be on one side. Look for the TIN on the outboard side of tires as mounted on the vehicle. If the TIN is not found on the outboard side then you will find it on the inboard side of the tire.

EXAMPLE: DOT MA L9 ABCD 1504

DOT	Department of Transportation This symbol certifies that the tire is in compliance with the U.S. Department of Transportation tire safety standards, and is approved for highway use.
MA	Code representing the tire manufacturing location. (2 digits)
L9 ABC D	Code representing the tire size. (2 digits) Code used by tire manufacturer. (1 to 4 digits)
15	Number representing the week in which the tire was manufactured. (2 digits)
04	Number representing the year in which the tire was manufactured. (2 digits)

Treadwear, Traction and Temperature Grades

Treadwear

The treadwear grade is a comparative rating based on the wear rate of the tire when tested under controlled conditions on a specified government test course. For example, a tire graded 150 would wear one and one-half (1^{1/2}) times as well on the government course as a tire graded 100. The relative performance of tires depends upon the actual conditions of their use, however, and may depart significantly from the norm due to variations in driving habits, service practices and differences in road characteristics and climate.

Traction

The traction grades, from highest to lowest, are AA, A, B and C. Those grades represent the tire's ability to stop on wet pavement as measured

under controlled conditions on specified government test surfaces of asphalt and concrete. A tire marked C may have poor traction performance.

Temperature

The temperature grades are A (the highest), B and C, representing the tire's resistance to the generation of heat and its ability to dissipate heat when tested under controlled conditions on a specified indoor laboratory test wheel. Sustained high temperature can cause the material of the tire to degenerate and reduce tire life, and excessive temperature can lead to sudden tire failure. The grade C corresponds to a level of performance which all passenger car tires must meet under the Federal Motor Vehicle Safety Standard No. 109. Grades B and A represent higher levels of performance on the laboratory test wheel than the minimum required by law.



Tires

Tire inflation pressures

N00939301955

Proper tire inflation pressure is essential for the safe and satisfactory operation of your vehicle. The wrong tire pressure will cause problems in three major areas:

- Safety

Too little pressure increases flexing in the tire and can cause tire failure. Too much pressure can cause a tire to lose its ability to cushion shock. Objects on the road and potholes could then cause tire damage that may result in tire failure.

- Economy

The wrong tire pressure can cause uneven wear patterns in the tire tread. These abnormal wear patterns will reduce the tread life, and the tire will have to be replaced sooner.

Too little pressure also makes it harder for the tire to roll, and this uses up more fuel.

- Ride comfort and vehicle stability

The superior riding experience built into your vehicle partly depends on the correct tire pressure. Too much pressure gives an uncomfortable and jarring ride. Too little pressure feels as if your vehicle is slow to respond.

Unequal tire pressures can make steering your vehicle uneven and unpredictable.

The tire pressure for your vehicle under normal driving conditions is listed on the placard attached to the driver's door sill.

(Refer to "Tire and loading information placard" on page 11-2.)

The recommended inflation pressures under normal driving conditions should be used for the tires listed below.

Item	Tire size	Front	Rear
Normal tire	P215/70R16	240 kPa, 35 psi	240 kPa, 35 psi
	P225/55R18	230 kPa, 33 psi	230 kPa, 33 psi
Compact spare wheel	T155/90D16	420 kPa, 60 psi	

Tire pressures should be checked, and adjusted if necessary, at least once a month.

Pressures should be checked more often whenever weather temperatures change severely, because tire pressures change with outdoor temperatures. The pressures listed are always "cold inflation pressure".

Cold inflation pressure is measured after the vehicle has been parked for at least three hours or is driven less than 1 mile (1.6 km) after having been parked for three hours.

Cold inflation pressure must not go above the maximum values molded into the tire sidewall. After driving several miles, your tire inflation pressure may increase 2 to 6 psi (14 to 41 kPa) from the cold inflation pressure. Do not let air out of the tires to get back to the specified cold pressure, or your tires will be too low.

Check your tires each time you refuel. If one tire looks lower than the others, check the pressure for all of them.

You should also take the following safety precautions:

- Keep your tires inflated to the recommended pressures. (See the tire and loading information placard attached to the driver's door sill.)
- Stay within the recommended load limits.
- Make sure that the weight of any load in your vehicle is evenly distributed.
- Drive at safe speeds.
- After filling your tires to the correct pressure, check them for damage and air leaks. Be sure to reinstall the caps on the valve stems.

9

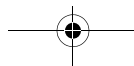

Replacing tires and wheels

N00939600241

CAUTION

- Avoid using different size tires from the one listed and the combined use of different types of tires, as this can affect driving safety.
Refer to “Tires and wheels” on page 11-5.
- On all-wheel drive vehicles, always use tires of the same size, same type, and same brand, and which have no wear differences. Using tires that differ in size, type, brand or the degree of wear, will increase the differential oil temperature, resulting in possible damage to the driving system. Further, the drive train will be subjected to excessive loading, possibly leading to oil leakage, component seizure, or other serious problems.
- Only Mitsubishi Motors Authorized wheels should be used, because your vehicle is equipped with a tire pressure monitoring system.
Use of another type of wheel risks air leaks and sensor damage, as it will not be possible to install the tire pressure sensor properly.

Tire maintenance

N00939700141

The following maintenance steps are recommended:

- Check tire pressures regularly.
- Have regular maintenance done on the wheel balance and front and rear suspension alignment.
- Rotate your tires regularly as described in the “Tire rotation” section on page 9-19.

Tread wear indicator

N00939800184

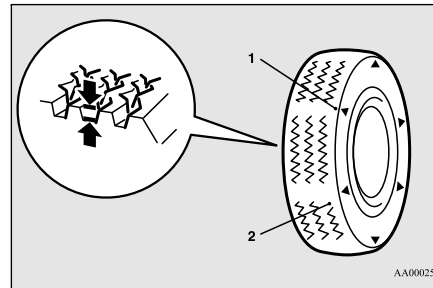

- 1- Location of the tread wear indicator
- 2- Tread wear indicator

Tread wear indicators are built into the original equipment tires on your vehicle to help you know when your tires should be replaced. Many states have laws requiring that you replace your tires at this point. These indicators are molded into the bottom of the tread grooves and will appear when the tire tread is worn down to 1/16 inch (1.6 mm).

When the bands appear next to one another in two or more places, replace your tires.

NOTE

- Tire wear indicators can have different marks and locations depending on the tire manufacturer.

Tire rotation

N00939901531

To even out the wear on your tires and make them last longer, Mitsubishi Motors Corporation recommends that you rotate your tires at the mileage listed in the “WARRANTY AND MAINTENANCE MANUAL”.

However, the timing for tire rotation may vary according to your vehicle condition, road surface conditions, and your own personal driving habits. Any time you notice unusual wear, rotate your tires as soon as possible.

When rotating tires, check for uneven wear, damage, and wheel alignment. Abnormal wear is usually caused by a wrong tire pressure, wheels that are not aligned properly, wheels that are out-of-balance, or severe braking.

Check with an authorized Mitsubishi Motors dealer or a repair facility of your choice to find out the reason for uneven tread wear.

Tires

The first tire rotation is the most important one. It will allow all your tires to wear evenly.

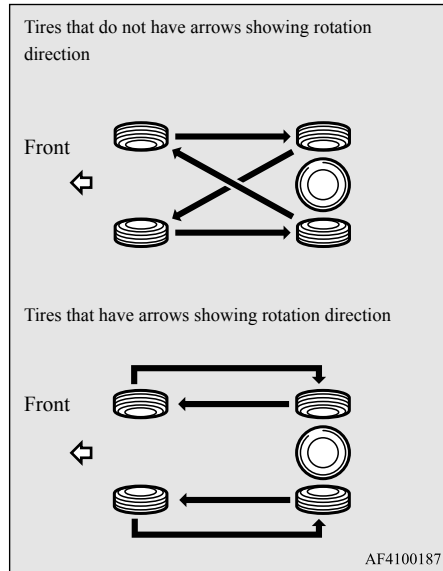

CAUTION

- A compact spare tire can be installed temporarily in place of a tire that has been removed during the tire rotation. However, it must not be included in the regular tire rotation sequence.

CAUTION

- If the tires have arrows (A) indicating the correct direction of rotation, swap the front and rear tires on the left-hand side of the vehicle and the front and rear tires on the right-hand side of the vehicle separately. Keep each tire on its original side of the vehicle. When installing the tires, make sure the arrows point in the direction in which the wheels will turn when the vehicle moves forward. Any tire whose arrow points in the wrong direction will not perform to its full potential.

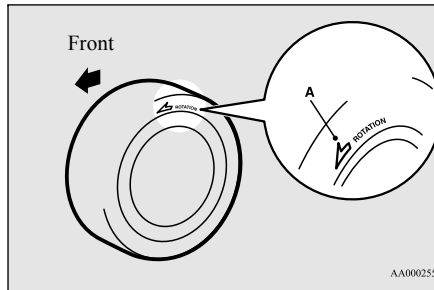

CAUTION

- Avoid the combined use of different types of tires. Using different types of tires can affect vehicle performance and safety.

Snow tires

N0094000320

In some areas of the country, snow tires are required for winter driving. If snow tires are required in your area, you must choose snow tires of the same size and type as the original tires provided with your vehicle. Snow tires should also be installed on all four wheels. Otherwise your safety and vehicle handling can be reduced.

Even where laws may permit it, snow tires should not be operated at sustained speeds over 75 mph (120 km/h).

CAUTION

- Only Mitsubishi Motors Authorized wheels should be used, because your vehicle is equipped with a tire pressure monitoring system. Use of another type of wheel risks air leaks and sensor damage, as it will not be possible to install the tire pressure sensor properly.

Tire chains

N00940100116

⚠ CAUTION

- Tire chains cannot be used on your vehicle. The clearance between the chains and the body is not sufficient to allow proper clearance, and the vehicle body might be damaged.

Clutch pedal free play (if so equipped)

N00940201101

To check the clutch pedal free play (A), turn off the engine and press the pedal until you feel resistance.

Clutch pedal free play:
.2 to .4 inch (4 to 9 mm)

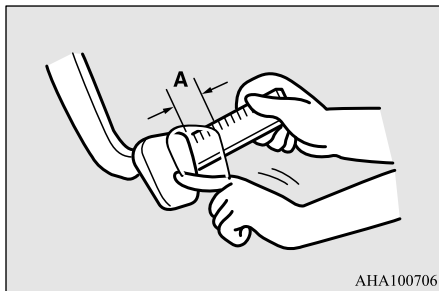

Brake pedal free play

N00940301346

To check the brake pedal free play (A), turn off the engine and press the brake pedal several times with your foot. Then press the pedal down with your fingers until you first feel resistance.

Brake pedal free play:
.1 to .3 inch (3 to 8 mm)

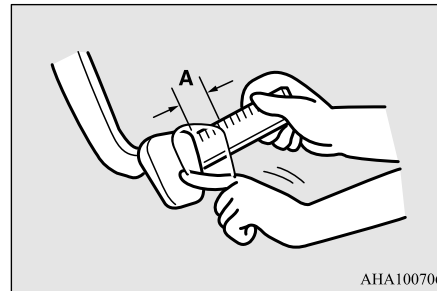

If the free play is not within these limits, take your vehicle to an authorized Mitsubishi Motors dealer or a repair facility of your choice for adjustment.

Clutch pedal free play (if so equipped)

Parking brake

N00940400249

Parking brake lever stroke

Check the parking brake lever travel occasionally. To check this, pull the lever up slowly and count the number of clicks of the ratchet. You should feel the parking brake grab between 6 to 7 notches (clicks). Also check to see if the lever stays gripped by the ratchet after pulling.

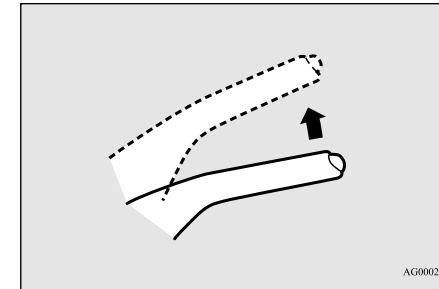

9

⚠ WARNING

- Continued operation of the vehicle with the parking brake lever out of adjustment may result in the vehicle moving when unattended.

Wiper blades

Wiper blades

N00940700138

Check the wiper blades occasionally. Clean them regularly to remove deposits of salt and road film. Use a sponge or cloth and a mild detergent or non-abrasive cleaner to clean the blades and glass areas.

Replace the blades if they continue to streak or smear.

NOTE

- Do not run the wipers on dry glass for a long time. This wears out the rubber and can scratch the glass.

9

During cold weather

If the blades are frozen to the windshield or rear window, do not operate the wipers until the ice has melted and the blades are freed, otherwise the wiper motor may be damaged.

Emission-control system maintenance

N00940800528

Your vehicle is equipped with an emission-control system that meets all the requirements of the U.S. Environmental Protection Agency

and Environment Canada. The emission-control system is made of:

- a positive crankcase ventilation system
- an evaporative emission-control system
- an exhaust emission-control system

To be sure the emission-control system works properly, have your vehicle inspected and maintained by an authorized Mitsubishi Motors dealer or a repair facility of your choice. This should be done at the time or mileage specified in the “WARRANTY AND MAINTENANCE MANUAL”.

These, and all the other “general” maintenance services listed in this manual, need to be performed to keep your vehicle running properly and reliably.

You should also have an inspection and service any time you suspect a malfunction.

NOTE

- To meet government regulations and promote cleaner air, your vehicle is equipped with an onboard diagnostic system (OBD). The engine electronic control module that controls OBD functions stores various data (especially about the exhaust emissions). This data will be erased if the battery cable is disconnected, which could make a rapid diagnosis difficult. Do not disconnect the battery cable when the engine malfunction indicator (“SERVICE ENGINE SOON” or “Check engine light”) is ON.

Spark plugs

N00940900228

Spark plugs must fire properly for good engine performance and emission-control.

Do not reuse them by cleaning or regapping. Change them at the mileage listed in the “WARRANTY AND MAINTENANCE MANUAL”.

NOTE

- Use the spark plugs listed under “Engine specifications” on page 11-4 or plugs that are exactly the same. Other plugs could cause engine damage, performance problems or radio noise.

Fuel hoses

N00941000040

Check the hose surfaces for any heat and mechanical damage, hard and brittle rubber, cracking, tears, cuts and abrasions. Pay special attention to the hoses closest to high heat sources such as the exhaust manifold. Check all the hose connections, such as clamps and couplings, to make sure they are secure and that there are no leaks. If you see any wear or damage, replace the hoses immediately.

Intake valve clearance

N00950100050

Have the valve clearance checked at an authorized Mitsubishi Motors dealer at the mileage specified in the “WARRANTY AND MAINTENANCE MANUAL”.

If the engine sounds abnormally loud, have adjustments made by an authorized Mitsubishi Motors dealer.

Fuel system (tank, pipe line and connection, and fuel tank filler cap)

N00941300173

Check these regularly for damage or leaks in the fuel lines and connections. Check the fuel tank filler cap for damage or looseness. Pay special attention to the fuel lines closest to

high heat sources such as the exhaust manifold.

WARNING

- If you see a fuel leak or if you smell fuel, do not run the engine. Any spark (including from the ignition), flame or smoking material could cause an explosion or fire. Call an authorized Mitsubishi Motors dealer or a repair facility of your choice for assistance.

Evaporative emission control system (except evaporative emission canister)

N00941400187

If the fuel-vapor vent line is clogged or damaged, the fuel-vapor mixture will escape, polluting the air.

Have the system checked at an authorized Mitsubishi Motors dealer at the mileage specified in the “WARRANTY AND MAINTENANCE MANUAL”.

General maintenance

N00941500247

The next pages list the maintenance service recommended by Mitsubishi Motors Corporation. In addition to the general maintenance that needs to be performed at the times listed,

General maintenance

there are other parts which do not usually need regular maintenance.

But, if any of these parts stops working properly, your vehicle performance could suffer. Have these items checked if you notice a problem with them.

See your authorized Mitsubishi Motors dealer for assistance, if you have any questions.

Disc brake pads

N00941600059

Good brakes are essential for safe driving. Check the brake pads for wear. For good braking performance, replace the brake pads with the same type pads as the originals.

9

Brake hoses

N00941700076

Brake hoses and tubing should be checked for:

- Severe surface cracking, scuffing or worn spots. If the fabric casing of the hose is showing through any cracks or worn spots in the rubber hose cover, the hose should be replaced. The brakes can fail if the hose wears through.
- Improper installation may cause twisting, or wheel, tire or chassis interference.



For cold and snowy weather

Ball joint, steering linkage seals and drive shaft boots

N00941800077

Check the following parts for damage and grease leaks:

- Ball joint boots of the front suspension and steering linkage
- Bellows on both ends of the drive shaft

Exhaust system

N00942200094

9

! WARNING

- **Carbon monoxide gas from your vehicle's exhaust is poisonous. Breathing these fumes can cause unconsciousness or death.**

The best way to keep carbon monoxide gas from entering inside your vehicle is to have the engine exhaust system properly serviced. Have a competent mechanic inspect the complete exhaust system and nearby body areas for broken, damaged, deteriorated, or mispositioned parts if you notice any of the following:

- A change in the sound of the exhaust system
- The smell of exhaust fumes inside the vehicle

9-24 Vehicle care and maintenance



- The underside or rear of the vehicle is damaged

Also check the exhaust system each time the vehicle is raised for lubrication, oil changes, or required service. Any open seams or loose connections could let dangerous exhaust fumes seep into the luggage compartment and passenger compartments.

Check for any of the following conditions:

- Check for holes or exhaust gas leaks caused by corrosion or damage.
- Check the joints and connections for looseness or exhaust gas leaks.
- Check the rubber hangers and brackets for damage.

Hood lock release mechanism and safety catch

N00942500101

The hood lock release mechanism and hood safety catch should be checked, cleaned, and oiled when needed for easy movement and to stop rust and wear. Use Multipurpose Grease NLGI Grade 2 sparingly for all sliding parts of the hood latch and release lever. Work the grease into the hood lock mechanism until all the movable surfaces are covered.

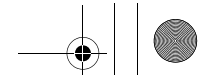
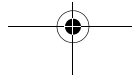

Also, put a light coat of the same grease on the safety catch wherever moving parts touch.

For cold and snowy weather

N00942600102

Ventilation slots

The ventilation slots in front of the windshield should be brushed clear after a heavy snowfall so that the operation of the heating and ventilation systems will not be impaired.

Weatherstripping

To prevent freezing of the weatherstripping on the doors, engine hood, etc., they should be treated with silicone grease.

Additional equipment (For regions where snow is encountered)

It is a good idea to carry a shovel or a short-handled spade in the vehicle during the winter so that you can clear away snow if you get stranded. A small hand-brush for sweeping snow off the vehicle and a plastic scraper for

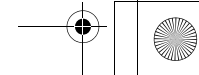

the windshield, side and rear window are also useful.

Fusible links

N00942700305

The fusible links will melt to prevent a fire if a large current attempts to flow through certain electrical systems.

In case of a melted fusible link, see your authorized Mitsubishi Motors dealer or a repair facility of your choice for inspection and replacement.

For the fusible links, please refer to “Fuse load capacities” on page 9-26.

WARNING

- **Fusible links must not be replaced by any other device. Failing to fit the correct fusible link may result in fire in the vehicle, property destruction and serious or fatal injuries at any time.**

Fuses

N00942800856

Fuse block location

To prevent damage to the electrical system from short-circuiting or overloading, each individual circuit is equipped with a fuse. The

fuse blocks are located in the passenger compartment and in the engine compartment.

Passenger compartment

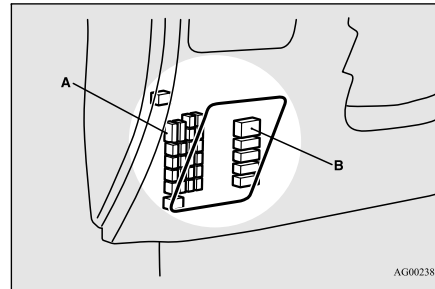

- A- Main fuse block
- B- Sub fuse block

The fuse blocks in the passenger compartment are located behind the fuse lid.

Main fuse block

1. Insert a screwdriver into the notch of the fuse lid and pry gently to remove it.

Fusible links

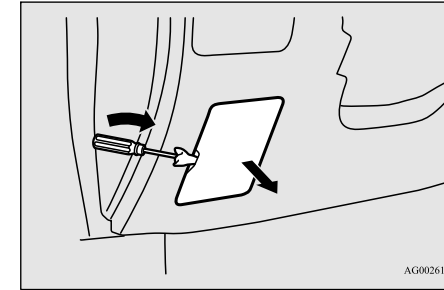

2. To put back the fuse lid, line up the fuse lid hook (A) with the clamp (B) on the instrument panel and push the lid back in.

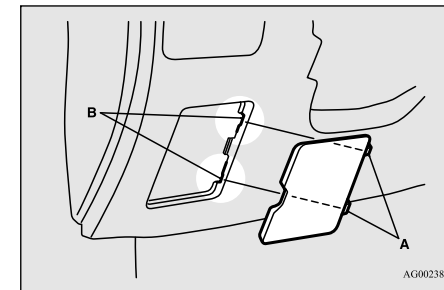

9

Fuses

Engine compartment

In the engine compartment, the fuse block is located as shown in the illustration.

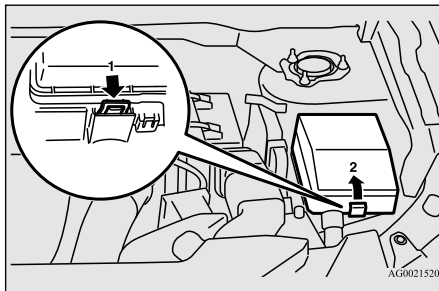

9

- 1- Push the lock lever.
- 2- Remove the fuse block cover.

Fuse load capacities

N00954801384

This fuse list shows the names of the electrical systems and their fuse capacities. There are spare fuses in the fuse block cover in the engine compartment. Always replace a blown fuse with one of the same capacity as the original.

Passenger compartment fuse location table

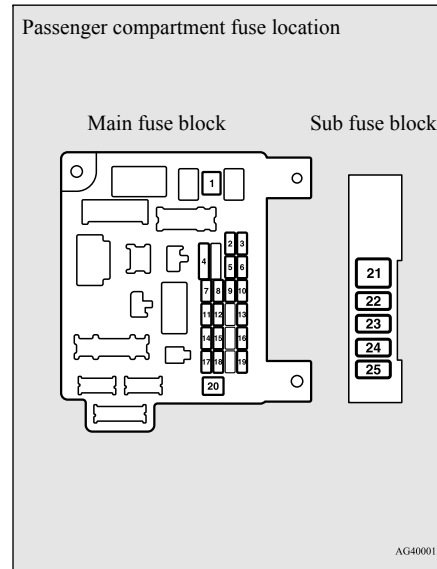

No.	Sym- bol	Electrical system	Capac- ity
1	⏏	Heater	30 A*
2	STOP	Stop lights (Brake lights)	15 A
3	⏏	Rear fog light	10 A

No.	Sym- bol	Electrical system	Capac- ity
4	⏏	Windshield wiper	30 A
5	⏏	Optional	10 A
6	⏏	Door locks	20 A
7	🎵	Radio	15 A
8	⏏	Control unit relay	7.5 A
9	☀	Interior lights (Dome lights)	15 A
10	⚠	Hazard warning flasher	15 A
11	⏏	Rear window wiper	15 A
12	🕒	Gauges	7.5 A
13	🚬	Cigarette lighter /Accessory socket	15 A
14	🔑	Ignition Switch	10 A
15	☀	Sunroof	20 A
16	📺	Outside rearview mirrors	10 A
17	🚗	All-wheel drive sys- tem	10 A
18	⏏	Back-up lights	7.5 A
19	⏏	Accessory socket	15 A

Fuses

No.	Symbol	Electrical system	Capacity
20		Power window control	30 A*
21		Defogger	30 A*
22		Heated door mirror	7.5 A
23		Passenger's power seat	25 (20) A
24		Driver's power seat	25 (20) A
25		Heated seats	30 A

*: Fusible link

- Some fuses may not be installed on your vehicle, depending on the vehicle model or specifications.
- The table above shows the main equipment corresponding to each fuse.



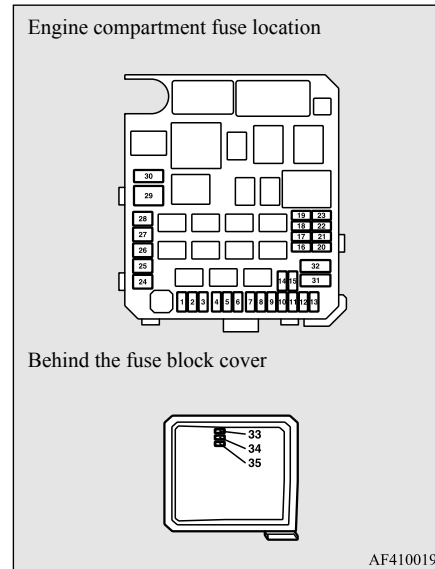









Engine compartment fuse location table





No.	Symbol	Electrical system	Capacity
1		Front fog lights	15 A
2		Engine	7.5 A
3		Automatic transaxle	20 A
4		Horn	10 A

No.	Symbol	Electrical system	Capacity
5		Alternator	7.5 A
6		Headlight washer	20 A
7		Air conditioning	10 A
8		ETV/Oil cooler fan (Twin Clutch SST)	15 A
9		Security horn	20 A
10		Wiper deicer	15 A
11	—	—	—
12		Power gate	30 A
13		Daytime running lights	10 A
14		Headlight (high beam) (left)	10 A
15		Headlight (high beam) (right)	10 A
16		Headlight (low beam) (left) Discharge	20 A
17		Headlight (low beam) (right) Discharge	20 A

Fuses

No.	Sym- bol	Electrical system	Capac- ity
18		Headlight (low beam) (left)	Halogen 10 A
19		Headlight (low beam) (right)	Halogen 10 A
20		ENG/POWER	10 A
21		Ignition coil	10 A
22		ENG/POWER	20 A
		Fuel line heater	25 A
23		Fuel pump	15 A
24		Starter	30 A*
25	—	—	—
26		Anti-lock braking system	40 A*
27		Anti-lock braking system	30 A*
28		Air conditioning con- denser fan motor	30 A*
29		Radiator fan	40 A*
30	IOD	IOD	30 A

9

No.	Sym- bol	Electrical system	Capac- ity
31		Audio amplifier	30 A
32		Diesel	30 A
33	—	Spare fuse	10 A
34	—	Spare fuse	15 A
35	—	Spare fuse	20 A

*: Fusible link

- Some fuses may not be installed on your vehicle, depending on the vehicle model or specifications.
- The table above shows the main equipment corresponding to each fuse.

There are no 7.5 A, 25 A or 30 A spare fuses. If a fuse of one of these capacities blows, replace it temporarily by borrowing one of the fuses indicated below.

7.5 A: 10 A spare fuse

25 A: 20 A spare fuse

30 A: 30 A audio amplifier fuse

Replace the borrowed fuse with a fuse that has the correct capacity as soon as possible.

Identification of fuse

Capacity	Color
7.5 A	Brown
10 A	Red
15 A	Blue
20 A	Yellow
25 A	Natural (white)
30 A	Green (fuse type) /Pink (fusible link type)
40 A	Green (fusible link type)

Fuse replacement

N00954901170

1. Before replacing a fuse, always turn off the electrical item concerned to the fuse and turn the ignition switch to the “OFF” position or put the operation mode in OFF.
2. There is a fuse remover (A) in the engine compartment fuse block.

Replacement of light bulbs

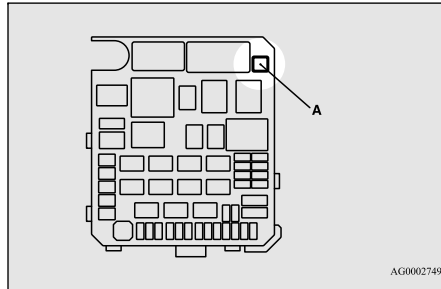

3. Clamp it on the fuse you wish to remove, and pull the fuse straight out from the fuse block.

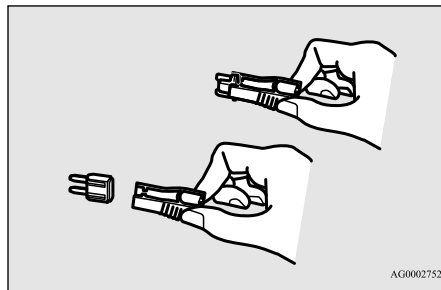

4. Use the fuse location diagrams and the matching tables, to check the fuse that is related to the problem. If the fuse is not blown, something else must be causing the problem. Have the system inspected by your authorized Mitsubishi Motors dealer or a repair facility of your choice.

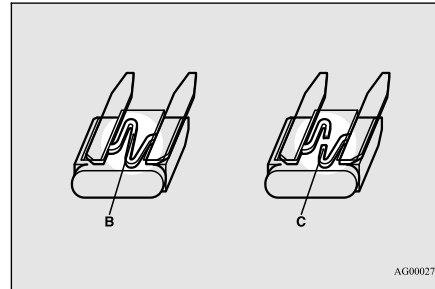

B- Fuse is OK
C- Blown fuse

5. Insert a new fuse of the same capacity securely into the appropriate slot.

CAUTION

- Never use a fuse with a capacity greater than the one listed or any substitute, such as wire, foil etc. This would cause the circuit wiring to heat up and could cause a fire.
- If the replacement fuse blows again after a short time, have the electrical system checked by an authorized Mitsubishi Motors dealer or a repair facility of your choice to find and correct the cause.

Replacement of light bulbs

N00942901405

Before replacing the bulb, be sure the light is off. Do not touch the glass part of the new bulb with your bare fingers; the oil from your skin will stay on the glass and dim or destroy the bulb when it gets hot.

CAUTION

- Bulbs are extremely hot immediately after being turned off. When replacing the bulb, wait for it to cool sufficiently before touching it. You could otherwise be burned.
- Do not install commercially available LED-type bulbs. Commercially available LED-type bulbs could adversely affect the operation of the vehicle, such as by preventing the lights and other vehicle equipment from operating properly.
- The headlight bulbs on this vehicle are high intensity discharge bulbs which contain mercury. If you need to have your vehicle disposed of, you should remove the high intensity discharge headlights before disposal. The removed high intensity discharge headlights should be disposed of or recycled in accordance with the applicable laws. [For vehicles sold in Canada]

Replacement of light bulbs

CAUTION

- For more information on safe handling, disposal, and recycling of the product, and the measures to be taken in case of accidental breakage, please visit <http://www.ec.gc.ca/mercure-mercury/>.

NOTE

- If you are unsure of how to carry out the work as required, it is recommended that these procedures be carried out by an authorized Mitsubishi Motors dealer or a repair facility of your choice.
- Be careful not to scratch the vehicle body when removing a light and lens.
- When it rains, or when the vehicle has been washed, the inside of the lens sometimes becomes temporarily foggy. This is the same phenomenon as when window glass mists up on a humid day, and does not indicate a functional problem.
When the light is switched on, the heat will remove the fog. However, if water gathers inside the light, please have it checked by an authorized Mitsubishi Motors dealer or a repair facility of your choice.

9

Bulb capacity

N00943000132

The bulb should only be replaced with a new bulb with the same rating and type. The type and rating are listed on the base of the bulb.

Outside

N00950302115

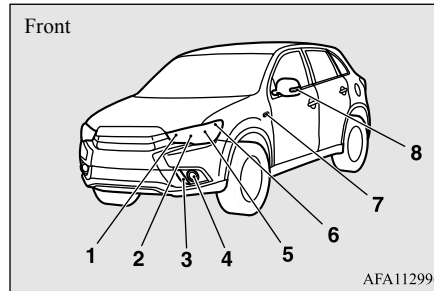

Description	Watt-age	ANSI Trade No. or Bulb type
1 Front turn signal light	21 W	WY21W
2 Headlight, high beam	60 W	HB3
3 Daytime running light* Parking light (Type 2)*	—	—

Description	Watt-age	ANSI Trade No. or Bulb type
4 Front fog light*	19 W	H16
5 Headlight, low beam (Halogen bulb) Headlight, low beam (Discharge bulb)	55 W	H11
	35 W	D2S
6 Front side-marker light Parking light (Type 1)*	5 W	WY5W
7 Side turn signal light (on fender)*	5 W	—
8 Side turn signal light (on outside rearview mirror)*	—	—

*: If so equipped

Replacement of light bulbs

WARNING

- **High intensity discharge headlights operate at high voltage. If you try to service any of the system components, you could be seriously injured or killed. Contact an authorized Mitsubishi Motors dealer or a repair facility of your choice whenever it is necessary to repair the high intensity discharge headlight or to replace the bulb.**

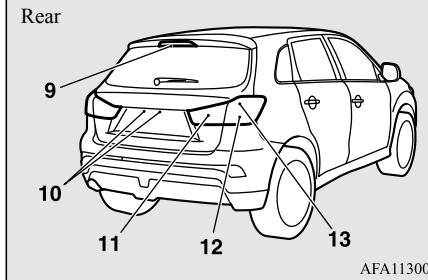

NOTE

- The rear side-marker light, the tail and stop light and the high-mounted stop light use an LED instead of the bulb. Check with an authorized Mitsubishi Motors dealer or repair facility of your choice when either light needs to be repaired or replaced.

NOTE

- It is not possible to repair or replace only the bulb for the side turn signal light. Check with an authorized Mitsubishi Motors dealer or a repair facility of your choice when the light needs to be repaired or replaced.
- The daytime running light/parking light (Type 2) and the side turn signal light (on outside rearview mirror) use an LED instead of the bulb. Check with an authorized Mitsubishi Motors dealer or repair facility of your choice when either light needs to be repaired or replaced.

	Item	Watt- age	ANSI trade No. or bulb type
9	High-mounted stop light	—	—
10	License plate light	5 W	W5W
11	Back-up light	16 W	W16W
12	Rear turn signal light	21 W	W21W
13	Rear side-marker light, and tail and stop light	—	—

Replacement of light bulbs

Compartment

N00950401744

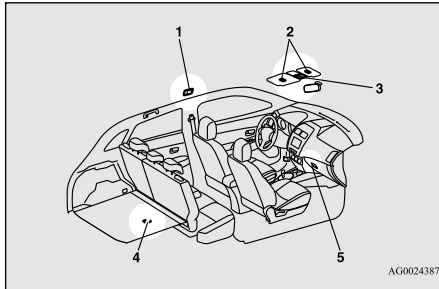

AG0024387

9

	Item	Wattage
1	Dome light (rear)*	8 W
2	Vanity mirror lights*	2 W
3	Dome light (front)/Reading light	8 W
4	Cargo room light	5 W
5	Glove compartment light	1.4 W

*: If so equipped

Headlights (low beam, except for vehicles equipped with high intensity discharge headlights)

N00901801144

1. Turn the cap (A) counterclockwise to remove it.

9-32 Vehicle care and maintenance

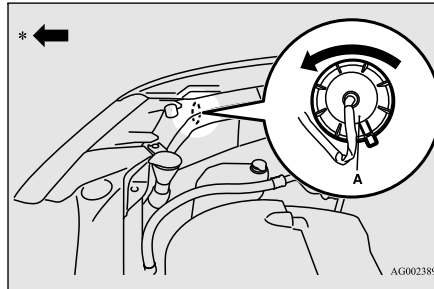

AG0023898

*- Front of the vehicle

2. Turn the bulb (B) counterclockwise to remove it.

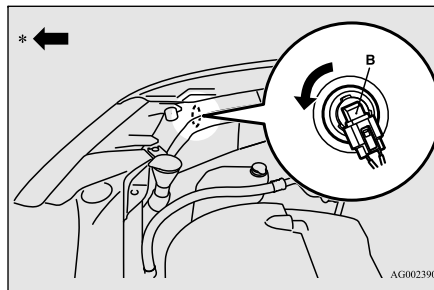

AG0023902

*- Front of the vehicle

3. While holding down the tab (C), pull out the socket (D).

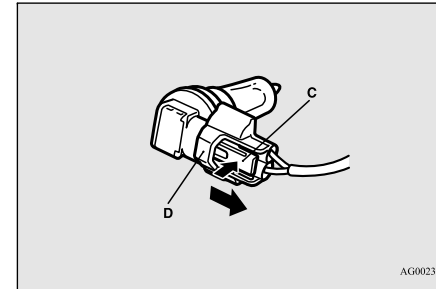

AG0023915

4. To install the bulb, perform the removal steps in reverse.

CAUTION

- Handle halogen light bulb with care. The gas inside a halogen light bulb is highly pressurized, so dropping, knocking, or scratching a halogen light bulb can cause it to shatter.

CAUTION

- Never hold the halogen light bulb with a bare hand, dirty glove, etc. The oil from your hand could cause the bulb to break the next time the headlights are used. If the glass surface is dirty, clean it with alcohol and let it dry completely before installing the bulb.

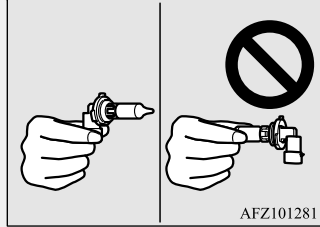

Headlights (high beam)

N00901901103

1. Turn the cap (A) counterclockwise to remove it.

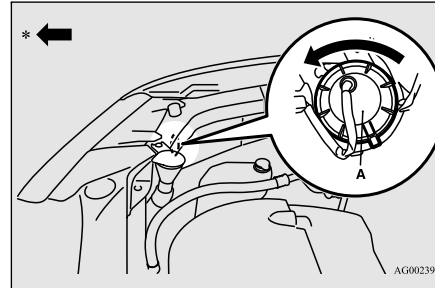

*- Front of the vehicle

2. Turn the bulb (B) counterclockwise to remove it.

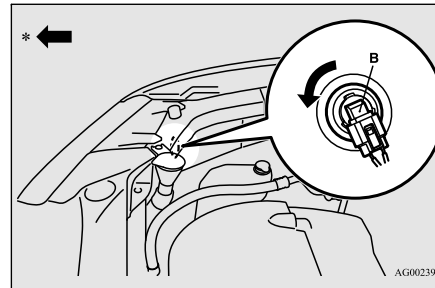

*- Front of the vehicle

3. While holding down the tab (C), pull out the socket (D).

Replacement of light bulbs

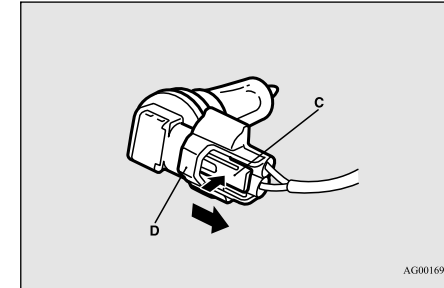

4. To install the bulb, perform the removal steps in reverse.

CAUTION

- Handle halogen light bulb with care. The gas inside a halogen light bulb is highly pressurized, so dropping, knocking, or scratching a halogen light bulb can cause it to shatter.

9

Replacement of light bulbs

CAUTION

- Never hold the halogen light bulb with a bare hand, dirty glove, etc. The oil from your hand could cause the bulb to break the next time the headlights are used. If the glass surface is dirty, clean it with alcohol and let it dry completely before installing the bulb.

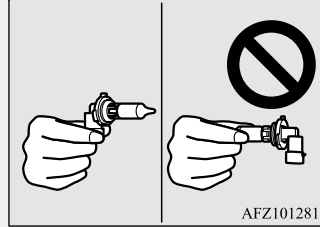

9

Headlights (low beam, for vehicles equipped with high intensity discharge headlights)

N00900301201

Do not attempt to disassemble or repair headlights, and do not attempt to replace their bulbs.

WARNING

- High intensity discharge headlights operate at high voltage. If you try to service any of the system components, you could be seriously injured or killed. Contact an authorized Mitsubishi Motors dealer or a repair facility of your choice whenever it is necessary to repair the high intensity discharge headlight or to replace the bulb.

Adjustment of headlight aim

N00943200121

The alignment of the headlights should be checked by an authorized Mitsubishi Motors dealer or a repair facility of your choice.

Front side-marker lights/parking lights (Type 1) (if so equipped)

N00917301740

1. Turn the socket (A) counterclockwise to remove it.

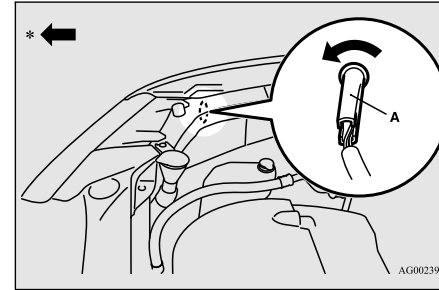

*- Front of the vehicle

2. Pull the bulb out of the socket.

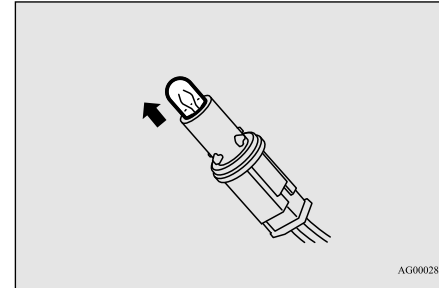

3. To install the bulb, perform the removal steps in reverse.

Replacement of light bulbs

Front turn signal lights

N00943401452

To remove

1. Remove the upper cover.
For information regarding how to remove the upper cover, refer to “Removing and installing the upper cover and duct” on page 9-11.
2. Turn the socket (A) counterclockwise to remove it.

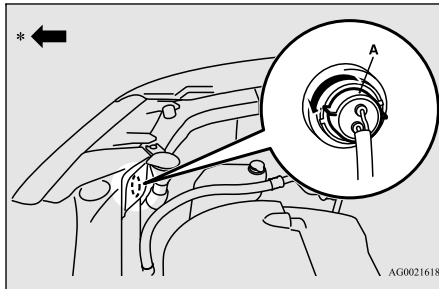

*- Front of the vehicle

3. Pull the bulb out of the socket.

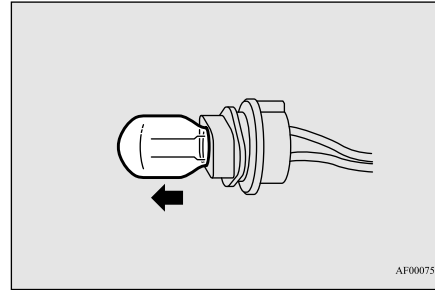

To install

1. To install the bulb, perform the removal steps in reverse.
2. Install the upper cover.
For information regarding how to install the upper cover, refer to “Removing and installing the upper cover and duct” on page 9-11.

Side turn signal lights (on fender) (if so equipped)

N00943501150

NOTE

- It is not possible to repair or replace only the bulb for the side turn signal light. Check with an authorized Mitsubishi Motors dealer or a repair facility of your choice when the light needs to be repaired or replaced.

Side turn signal lights (on outside rearview mirror) (if so equipped)

N00943501163

NOTE

- The side turn signal lights (on outside rearview mirror) uses an LED instead of the bulb. Check with an authorized Mitsubishi Motors dealer or a repair facility of your choice when the light needs to be repaired or replaced.

Front fog lights (if so equipped)

N00943601962

1. Remove the clip (A).

Vehicle care and maintenance 9-35

Replacement of light bulbs

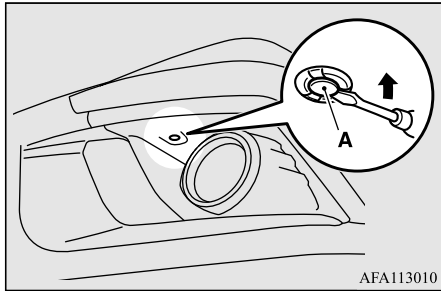

2. Insert a straight blade (or minus) screwdriver with a cloth over its tip into the light cover (B) and pry gently to remove it.

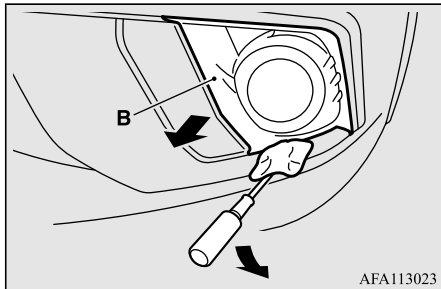

3. Remove the screws (C) and remove the light unit.

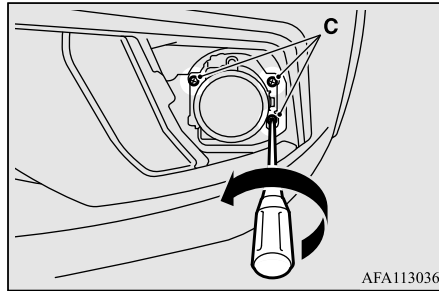

NOTE

- Except for vehicles equipped with daytime running lights, when unfastening the screws, be careful not to move the beam position adjustment screw (D).

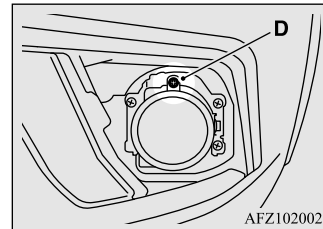

4. While holding down the tab (E), pull out the socket (F).

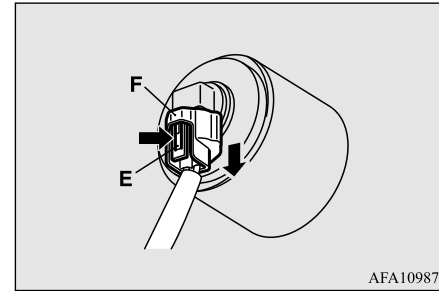

5. Turn the bulb (G) counterclockwise to remove it.

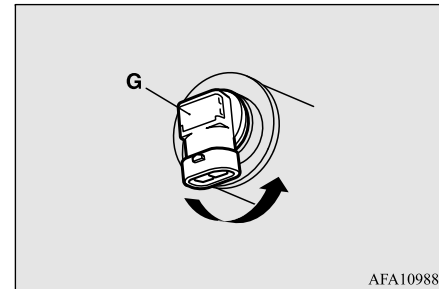

6. To install the bulb, perform the removal steps in reverse.

CAUTION

- Handle halogen light bulb with care. The gas inside a halogen light bulb is highly pressurized, so dropping, knocking, or scratching a halogen light bulb can cause it to shatter.

Replacement of light bulbs

CAUTION

- Never hold the halogen light bulb with a bare hand, dirty glove, etc. The oil from your hand could cause the bulb to break the next time the fog lights are used. If the glass surface is dirty, clean it with alcohol and let it dry completely before installing the bulb.

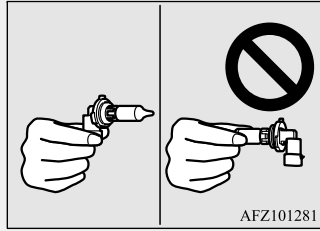

Daytime running lights (if so equipped)/parking lights (Type 2) (if so equipped)

N00900301214

NOTE

- The daytime running light/parking lights (Type 2) uses an LED instead of the bulb. Check with an authorized Mitsubishi Motors dealer or a repair facility of your choice when the light needs to be repaired or replaced.

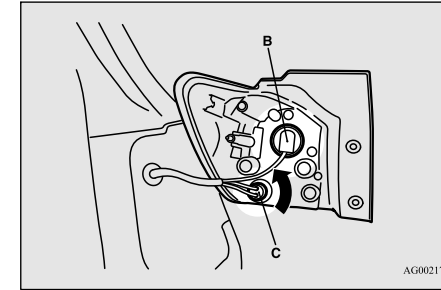

- B- Rear side-marker light, and tail and stop light (LED)
- cannot be replaced
- C- Rear turn signal light

Rear combination lights

N00943701530

1. Remove the screws (A) that hold the light unit and remove the light unit.

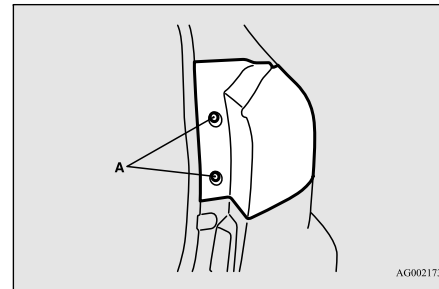

2. Turn the socket and bulb assembly counterclockwise to remove it.

NOTE

- When refitting the clip, first insert part (H) of the clip into the hole and then press part (I) into it.

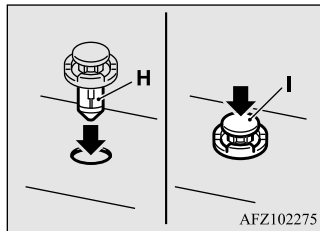

NOTE

- The rear side-marker light, and the tail and stop light uses an LED instead of the bulb. Check with an authorized Mitsubishi Motors dealer or a repair facility of your choice when the light needs to be repaired or replaced.

3. Pull the bulb out of the socket.

Replacement of light bulbs

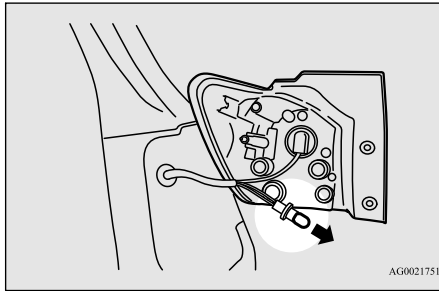

2. Insert a screwdriver into the notch of the cover and pry gently to remove the cover.

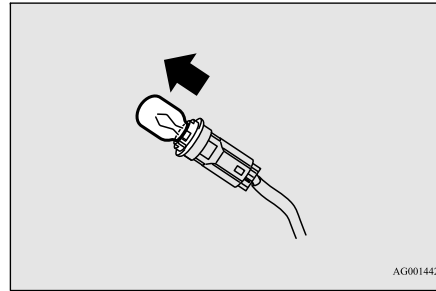
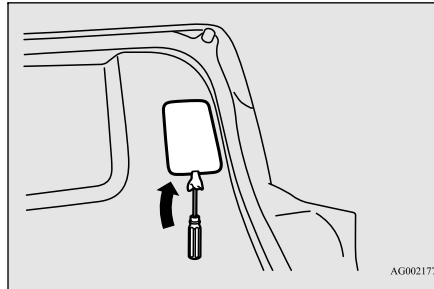

4. To install the bulb, perform the removal steps in reverse.

5. To install the bulb, perform the removal steps in reverse.

9

NOTE

- When mounting the light unit, align the groove (D) on the light unit with the clip on the body and the pin (E) on the unit with the hole in the body.

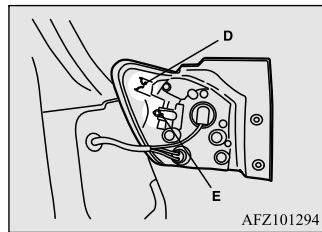

NOTE

- Wrap a cloth around the tip of the screwdriver to keep from scratching the cover.

3. Turn the socket counterclockwise to remove it.

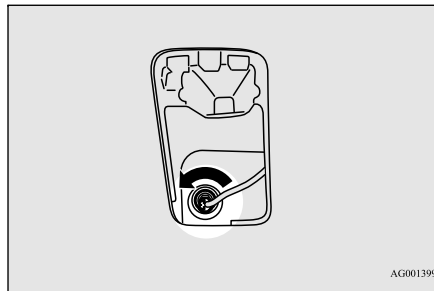

NOTE

- When installing the lid, align the tab on the lid with the hole on the vehicle side.

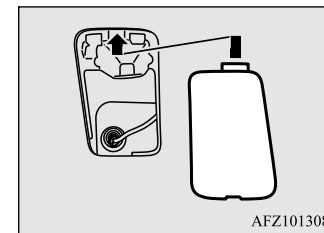

Back-up lights

N00929101077

1. Open the liftgate.

4. Pull the bulb out of the socket.

Vehicle care precautions

License plate lights

N00944000386

1. When removing the light unit (A), push it toward the left side of the vehicle body.

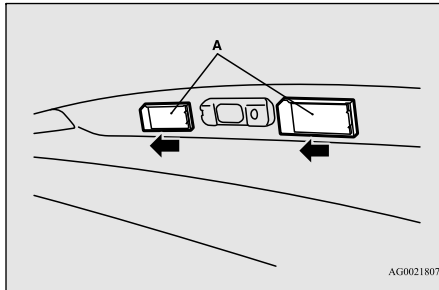

2. Remove the socket (B) and bulb assembly by turning it counterclockwise.

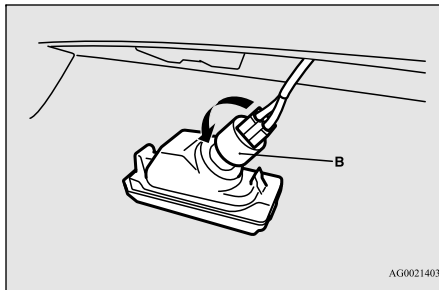

3. Pull the bulb out of the socket.

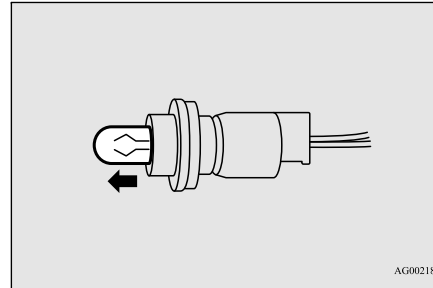

4. To install the bulb, perform the removal steps in reverse.

NOTE

- When mounting the light unit, insert tab (C) first then align tab (D) with its hole.

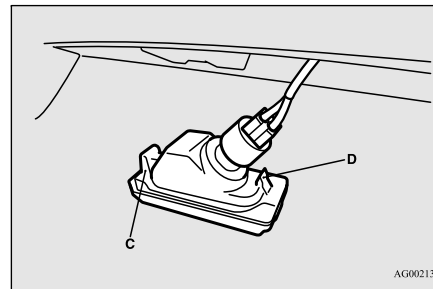

High-mounted stop light

N00943900102

NOTE

- The high-mounted stop light uses an LED instead of the bulb. Check with an authorized Mitsubishi Motors dealer or a repair facility of your choice when the light needs to be repaired or replaced.

Vehicle care precautions

N00945100166

In order to maintain the value of your vehicle, perform regular maintenance using the proper materials and procedures. Be sure to use only those materials and procedures that meet your local environmental pollution control regulations. Choose the materials you will use carefully, to be sure that they do not contain corrosives. If you are not sure, contact an authorized Mitsubishi Motors dealer for help in choosing these materials.

Cleaning the inside of your vehicle

CAUTION

● Cleaning products can be dangerous. Some are poisonous and others are highly flammable. Some are dangerous if you breathe their fumes in a closed space. When you use anything in a container to clean your vehicle, be sure to follow the instructions. Always open your vehicle doors or windows when you're cleaning the inside. Never use the following chemicals to clean your vehicle:

- Gasoline
- Carbon Tetrachloride
- Benzine
- Kerosene
- Naphtha
- Acetone
- Turpentine
- Paint Thinner
- Lacquer Thinner
- Nail Polish Remover

These can all be dangerous, and they all can damage your vehicle.

Cleaning the inside of your vehicle

N0094520095

After washing the inside of your vehicle with any cleaner, wipe it dry in a shady, well ventilated area.

9

CAUTION

● Do not use organic substances (solvents, benzine, kerosene, alcohol, gasoline, etc.) or alkaline or acidic solutions. These chemicals can cause discoloring, staining or cracking of the surface. If you use cleaners or polishing agents, make sure their ingredients do not include the substances mentioned above.

NOTE

● Always read the instructions on the cleaner label.

Plastic, vinyl leather, fabric and flocked parts

N00945300142

1. Lightly wipe these off with a soft cloth soaked in a 3% solution of gentle soap and water.
2. To rinse, dip the cloth in fresh water, wring it out well, and wipe off all the soap.

NOTE

● Do not use cleaners, conditioners, and protectants containing silicones or wax. Such products, when applied to the instrument panels or other parts, may cause reflections on the windshield and obscure vision. Also, if such products get on the switches of the electrical accessories, it may lead to failure of these accessories.

Upholstery

N00945500128

1. To maintain the value of your new vehicle, maintain the upholstery carefully and keep the interior clean. Use a vacuum cleaner and brush to clean the seats. If stained, vinyl and synthetic leather should be cleaned with an appropriate cleaner. Cloth fabrics can be cleaned with either upholstery cleaner or a 3% solution of gentle soap in lukewarm water.
2. Clean the carpeting with a vacuum cleaner and remove any stains with carpet cleaner. Oil and grease can be removed by lightly dabbing with a clean white cloth and spot remover.

NOTE

- If fuzzing is difficult to remove from the seat upholstery, draw a suitable defuzzing brush over the surface in one direction.

Genuine leather (if so equipped)

N00945600187

1. To clean, lightly wipe the leather with a soft cloth soaked in a 5% solution of gentle soap and water.
2. To rinse, dip the cloth in fresh water, wring it out well, and wipe off all the soap.
3. To preserve and protect, use a leather protecting agent on the genuine leather surface.

NOTE

- If genuine leather is wet with water, wipe it with a dry, soft cloth. If left damp, mildew may grow.
- The genuine leather surface can be damaged if brushed with a nylon or synthetic fiber brush.
- Organic solvents such as benzene, kerosene, alcohol, gasoline, or acid or alkaline solvents can discolor the genuine leather surface and should not be used.
- Genuine leather can mildew if not kept clean. Clean up any oil stains immediately.

NOTE

- The genuine leather surface may harden and shrink if it is exposed to the direct sunlight for long hours. When your vehicle is parked, place it in the shade as much as possible.
- When the temperature of the vehicle interior rises in summer, vinyl products left on the genuine leather seat may deteriorate and stick to the seat.

Cleaning the outside of your vehicle

N00945700058

To protect your vehicle's finish, wash it often and thoroughly. If desired, you may wax your vehicle using a nonabrasive automobile wax.

Foreign material

N00945800033

Industrial pollution, road tar, bird droppings, tree sap, insect remains, sea water and other foreign matters can damage the finish on your vehicle.

Generally, the longer any foreign material stays on the finish, the worse the damage. Wash your vehicle as soon as possible whenever the finish gets soiled.

Cleaning the outside of your vehicle**Washing**

N00945901682

Chemicals contained in the dirt and dust picked up from air, rain, snow, or road surfaces can damage the paint and body of your vehicle if left on.

Frequent washing and waxing is the best way to protect your vehicle from this damage.

Do not wash the vehicle in direct sunlight. Park the vehicle in the shade and spray it with water to remove dust. Next, using plenty of clean water and a car washing mitt or sponge, wash the vehicle from top to bottom.

Use a mild car washing soap if necessary. Rinse thoroughly and wipe dry with a chambray or soft cloth. After washing the vehicle, carefully clean the joints and flanges of the doors, hood, etc., where dirt is likely to remain.

9**CAUTION**

- When washing the underside of your vehicle or the wheels, wear a pair of gloves to protect your hands.
- If your vehicle has rain sensor wipers, place the wiper switch lever in the "OFF" position to deactivate the rain sensor before washing the vehicle. Otherwise, the wipers will operate in the presence of water spray on the windshield and may get damaged as a result.

Cleaning the outside of your vehicle

⚠ CAUTION

- Never spray or splash water on the electrical parts in the engine compartment. This may damage them. Be careful also when washing the underbody to ensure that water does not enter the engine compartment.
- Avoid automatic car washers that use rotating brushes. These brushes may scratch the paint surface and make it dull. Scratches are more noticeable on darker colored vehicles.
- Some hot water washing equipment uses high pressure and heat to clean your vehicle. Because hot water can damage plastics parts and seep inside your vehicle, make sure you do the following when using such equipment:
 - Keep the washing nozzle at least 28 inches (70 cm) away from the vehicle body.
 - When washing around the door glass, hold the nozzle at a distance of more than 28 inches (70 cm) and at a right angle to the glass surface.
- Make sure to do the following when using an automatic car wash, with help from either this manual or the car wash operator, to avoid damaging your vehicle:
 - Fold the outside rearview mirrors.
 - Tape the wiper arm assembly.
 - If your vehicle is equipped with a rear spoiler or roof rails, check with the car wash operator before using the car wash.

9

⚠ CAUTION

- If your vehicle is equipped with the rain sensor wipers, place the wiper switch lever in the "OFF" position to deactivate the rain sensor.

During cold weather

Salt and other chemicals spread on winter roads in some geographical areas can have a detrimental effect on the vehicle underbody. You should flush the underbody with a high pressure hose every time you wash the outside of your vehicle.

Take special care to remove mud or other debris which could trap and hold salt and moisture.

After washing your vehicle, wipe off all waterdrops from the rubber parts around the doors to prevent the doors from freezing.

📖 NOTE

- When the door is frozen, opening it by force may tear off or crack the rubber gasket installed around the door. Pour warm water to melt the ice. Be sure to thoroughly wipe off the water after opening the door. To prevent freezing of the weatherstripping on the doors, hood, etc., treat with silicone lubricant.

Waxing

N0094600234

Wax your vehicle once or twice a year, or when water does not bead up on the paint.

Use a soft cloth to put a small amount of wax on the painted surfaces. After the wax has dried, polish with a dry soft cloth.

Do not wax your vehicle in direct sunlight.

You should wax when the painted surfaces are cool.

⚠ CAUTION

- Waxes containing high abrasive compounds should not be used. These waxes remove rust and stain effectively from the paintwork, but are harmful to the finish of the paint, because they also remove paint/clearcoat. They are also harmful to other glossy surfaces such as the grille, trim, moldings, etc.
- Do not use gasoline, benzine, kerosene or paint thinners to remove road tar or other dirt from the vehicle surface.
- Do not put wax on the areas having black matte coating because it can cause uneven discoloration, patches, blurs, etc. If these get wax on them, wipe the wax off right away with a soft cloth and warm water.

Polishing

N00946100046

If painted surfaces have been severely damaged and lost their original luster and color tone, polish the surface lightly with a fine polishing compound. Avoid limiting your polishing to the damaged surface only; polish a somewhat wider area, moving the polishing cloth in one direction. After polishing, flush the compound from the surface and apply a coat of wax to regain a beautiful luster.

Damaged paint

N00946200047

Small cracks and scratches in the paint coat should be touched up as soon as possible with touch-up paint to prevent corrosion.

Check body areas facing the road or the tires carefully for damage to the paint caused by flying stones, etc. The paint code number for your vehicle can be found on the vehicle information code plate in the engine compartment.

Cleaning plastic parts

N00946300194

Use a sponge or chamois to clean these parts. If a vehicle wax sticks to a gray or black rough surface of the bumper, molding or lights, the surface may appear white in color.

In this case, wipe it off using lukewarm water and a soft cloth or chamois.

CAUTION

- Do not use a scrubbing brush or other rough scrubber as these may damage the plastic surface.
- Do not use wax containing compounds (polishing powder) which may damage the plastic surface.
- Do not let plastic parts get soiled with gasoline, oil, brake fluids, engine oils, greases, paint thinner, and sulfuric acid (battery electrolyte), as such substances will cause stains, cracks, or discoloration.

If any of these get on a plastic part, wipe them up with a soft cloth or chamois and a mild solution of soap and water. Then rinse them immediately with water.

Chrome parts

N00946400052

To prevent spots and corrosion of chrome parts, wash with water, dry thoroughly, and apply a nonabrasive automotive wax. If the chrome is severely damaged or pitted, use a commercially available chrome polish.

Aluminum wheels (if so equipped)

N00946500183

1. Remove dirt using a wet sponge.

Cleaning the outside of your vehicle

2. Use a mild detergent on any dirt that cannot be removed easily with water. Rinse off the detergent after washing the wheel.
3. Dry the wheel thoroughly using a chamois leather or a soft cloth.

CAUTION

- Do not use a brush or other hard implement on the wheels.
- Do not use any cleaner that contains an abrasive substance or is acidic or alkaline. Doing so could cause the coating on the wheels to peel or become discolored or stained.
- Do not directly apply hot water using a steam cleaner or by any other means.
- Contact with seawater or road salt used for de-icing can cause corrosion. Rinse off such substances as soon as possible.

9

Window glass

N00946600054

The window glass can usually be cleaned using only a sponge and water. Glass cleaner can be used to remove wax, oil, grease, dead insects, etc. After washing the glass, wipe it dry with a clean, dry, soft cloth.



Cleaning the outside of your vehicle

Wiper blades

N00946700068

Use a soft cloth and glass cleaner to remove grease, dead insects, etc., from the wiper blades.

Replace the wiper blades when they no longer clean the windshield and rear window properly.

Engine compartment

N00947000071

Never spray or splash water on the electrical accessories in the engine compartment. This puts the engine at risk of being damaged.

Do not bring the circumferential parts, the plastic parts and so on into contact with sulfuric acid (battery electrolyte) which may crack, stain or discolor them.

If they are in contact, wipe off with soft cloth, chamois or the like and an aqueous solution of neutral detergent then immediately rinse the affected parts with plenty of water.

9

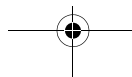
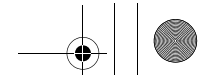

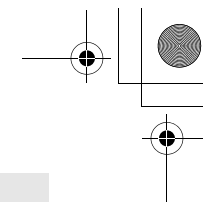

Customer assistance/Reporting Safety Defects

Consumer information (For vehicles sold in U.S.A.)	10-2
Reporting Safety Defects	10-2
Important facts to know in case of an accident	10-4

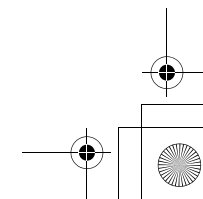
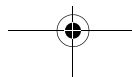
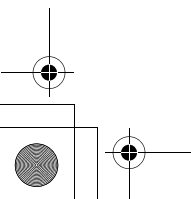
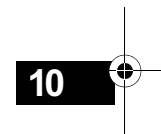
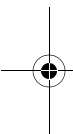



Consumer information (For vehicles sold in U.S.A.)

Consumer information (For vehicles sold in U.S.A.)

N01047100171

This information is provided in compliance with the requirements of the National Highway Traffic Safety Administration, Department of Transportation. It provides the purchasers and/or prospective purchasers with information on reporting safety defects.

Uniform tire quality grading

DOT quality grades - All passenger vehicle tires must conform to Federal Safety Requirements in addition to these grades. The specific grade rating in each grade category is shown on the side wall of the tires on your vehicle.

10

Treadwear

The treadwear grade is a comparative rating based on the wear rate of the tire when tested under controlled conditions on a specified government test course. For example, a tire graded 150 would wear one and one-half ($1\frac{1}{2}$) times as well on the government course as a tire graded 100. The relative performance of tires depends upon the actual conditions of

their use, however, and may depart significantly from the norm due to variations in driving habits, service practices and differences in road characteristics and climate.

Traction AA, A, B, C

The traction grades, from highest to lowest, are AA, A, B and C. Those grades represent the tire's ability to stop on wet pavement as measured under controlled conditions on specified government test surfaces of asphalt and concrete. A tire marked C may have poor traction performance.

WARNING

- The traction grade assigned to this tire is based on straight-ahead braking traction tests, and does not include acceleration, cornering, hydroplaning, or peak traction characteristics.

Temperature A, B, C

The temperature grades are A (the highest), B and C, representing the tire's resistance to the generation of heat and its ability to dissipate heat when tested under controlled conditions on a specified indoor laboratory test wheel. Sustained high temperature can cause the

material of the tire to degenerate and reduce tire life, and excessive temperature can lead to sudden tire failure. The grade C corresponds to a level of performance which all passenger car tires must meet under the Federal Motor Vehicle Safety Standard No. 109. Grades B and A represent higher levels of performance on the laboratory test wheel than the minimum required by law.

WARNING

- The temperature grade for this tire is established for a tire that is properly inflated and not overloaded. Excessive speed, underinflation, or excessive loading, either separately or in combination, can cause heat buildup and possible tire failure.

Reporting Safety Defects

N01047201531

If you believe that your vehicle has a defect which could cause a crash or could cause injury or death, you should immediately inform the National Highway Traffic Safety Administration (NHTSA) in addition to notifying Mitsubishi Motors Corporation.

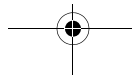

Reporting Safety Defects

If NHTSA receives similar complaints, it may open an investigation, and if it finds that a safety defect exists in a group of vehicles, it may order a recall and remedy campaign. However, NHTSA cannot become involved in individual problems between you, your dealer, or Mitsubishi Motors Corporation.

To contact NHTSA, you may call the Vehicle Safety Hotline toll-free at 1-888-327-4236 (TTY: 1-800-424-9153); go to <http://www.safercar.gov>; or write to:

NHTSA Headquarters
1200 New Jersey Avenue, SE
West Building
Washington, DC 20590

You can also obtain other information about motor vehicle safety from <http://www.safercar.gov>.

For vehicles sold in U.S.A.

To contact Mitsubishi Motors North America, Inc. call 1-888-648-7820 or write to:

Mitsubishi Motors North America, Inc.
Customer Relations Department
P.O. Box 6400
Cypress, CA 90630-0064

For vehicles sold in Canada

If you live in Canada, and you believe that your vehicle has a safety defect, you should immediately notify Transport Canada, in addition to notifying Mitsubishi Motor Sales of Canada, Inc. You may write to:

Transport Canada
330 Sparks Street
Tower C
Ottawa, Ontario K1A 0N5

To contact Mitsubishi Motor Sales of Canada, Inc. call 1-888-576-4878 or write to:

Mitsubishi Motor Sales of Canada, Inc.
Customer Relations Department
P.O. Box 41009
4141 Dixie Road
Mississauga, ON L4W 5C9

For vehicles sold in Puerto Rico

To contact Mitsubishi Motor Sales of Caribbean, Inc. call 1-787-251-8715 or write to:

Mitsubishi Motor Sales of Caribbean, Inc.
Customer Service Department
P.O. Box 192216
SAN JUAN PR 00919-2216

For vehicles sold in Guam

To contact Triple J Enterprises Inc.

Customer assistance/Reporting Safety Defects 10-3



Important facts to know in case of an accident

call (671)649-3673 or write to:

Triple J Enterprises, Inc.
P.O. Box 6066
TAMUNING
GUAM 96931

For vehicles sold in Saipan

To contact Triple J Motors
call (670)234-7133 or write to:

Triple J Motors
P.O. Box 500487
SAIPAN, MP96950-0487

For vehicles sold in American Samoa

To contact Pacific Marketing Inc.
call 684(699)9140 or write to:

Pacific Marketing, Inc.
P.O. Box 698
PAGO PAGO,
AMERICAN SAMOA AS, 96799

10-4 Customer assistance/Reporting Safety Defects



Important facts to know in case of an accident

N01047300098

We hope you will never be involved in an accident, but there is always that potential danger. So, please be sure to buckle up and drive safely.

In the event of an accident

- Remain calm.
- Check for injuries. Report all injuries to the police, and, if necessary, call for an ambulance.
- Record all the details of the accident. This will provide you with accurate records of the accident for discussions with your insurance company and other persons who may be acting on your behalf.

Key information to discuss with your insurance company

- Understand your repair estimate before approving repairs.
- Choosing the repair shop and the brands of parts that they use on your vehicle is your decision.

- Ask for genuine Mitsubishi Motors parts. Many times, to save money, your insurance company will recommend imitation parts that do not meet the original specifications of fit, finish, corrosion resistance or workmanship.

Mitsubishi Motors built-in protection

The strength and integrity built into your Mitsubishi vehicle is the result of a specific design referred to as "Energy Management". Individual body parts are designed to act as one unit in the event of an accident. Shock waves are absorbed by protective panels or are channeled around the passenger compartment. This important feature is possible because high tensile steel is used in Mitsubishi panels and structural parts, something that cannot be guaranteed by the manufacturers of imitation parts. All Genuine Mitsubishi body panels and support brackets are designed and constructed as important protection features in the event of an accident. By replacing body parts with imitations, your vehicle may no longer meet original equipment specifications.

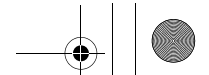

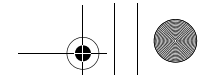

Important facts to know in case of an accident

Consumer rights (For vehicles sold in U.S.A.)

Remember to ask for genuine Mitsubishi Motors parts.

As a consumer requesting repair on your vehicle, you have consumer rights. Across the country, State Insurance Commissioners have begun considering rules on the use of non-OEM parts. This could mean that repair shops will have to disclose to the consumer, when they intend to use non-OEM parts. Since regulations are not consistent on this point, remember you have a choice. So, if you want genuine Mitsubishi Motors parts, you may have to specifically request them. Make certain your insurance company understands imitations are not to be used in the repair of your vehicle. You deserve the best genuine Mitsubishi Motors parts.

10

Genuine Mitsubishi Motors parts

Genuine Mitsubishi Motors parts are built with the high quality and durability standards you expect. Genuine Mitsubishi Motors replacements parts are your guarantee that your vehicle will have all the technological advantages and maintain the style and protection of a brand new Mitsubishi Motors.

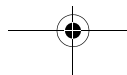

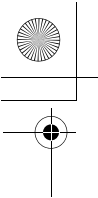

Handwriting practice lines consisting of ten horizontal dashed lines.

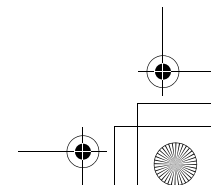
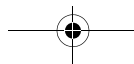
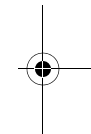
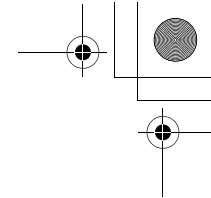
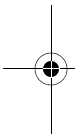

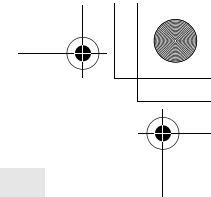

Specifications

Vehicle labeling	11-2
Vehicle dimensions	11-3
Vehicle weights	11-3
Engine specifications	11-4
Battery	11-4
Tires and wheels	11-5
Capacity	11-5

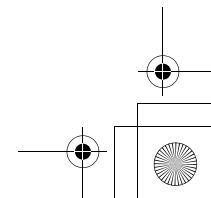
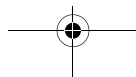
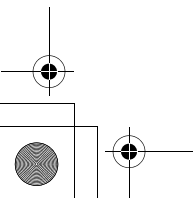
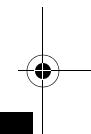
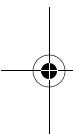

Vehicle labeling

Vehicle labeling

N01147401879

Keep a record of the chassis number and vehicle identification number. Such information will assist police if your vehicle is stolen.

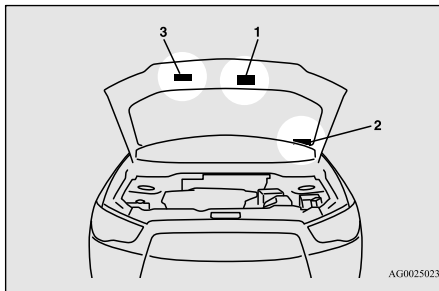

11

1 - Vehicle emission control information label

The vehicle emission control information label is affixed on the underside of the engine hood.

2 - Vehicle identification number plate

The vehicle identification number is stamped on the plate riveted to the left front corner of the vehicle body. It is visible from outside of the vehicle through the windshield.

3 - Air conditioning label

The air conditioning label is affixed on the inside panel of the engine hood.

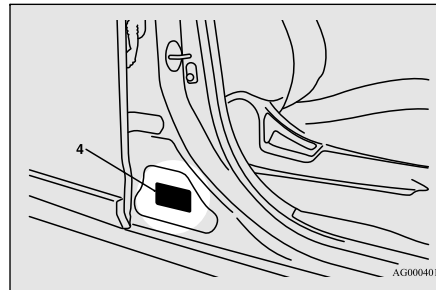

4 - Vehicle information code plate

The vehicle information code plate is located on the front passenger door sill.

Engine model/serial number

The engine model and serial number are stamped on the engine cylinder block as shown in the illustration.

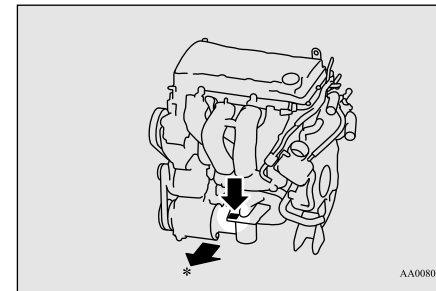

*- Front of the vehicle

Tire and loading information placard

N01148100603

The tire and loading information placard is located on the driver's door sill.

Vehicle dimensions

Overall width	71.3 in (1,810 mm)
Overall height	64.8 in (1,645 mm)
Wheel base	105.1 in (2,670 mm)

Certification label

N01148200167

The certification label is located on the driver's door sill.

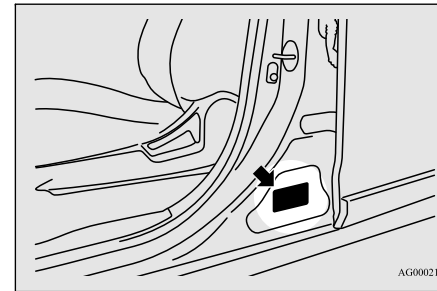
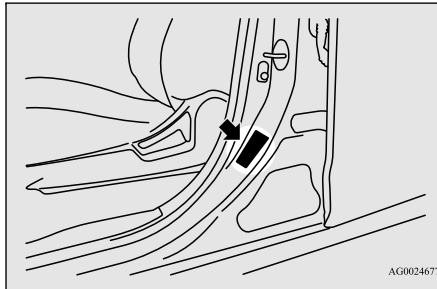

EXAMPLE

TIRE AND LOADING INFORMATION RENSEIGNEMENTS SUR LES PNEUS ET LE CHARGEMENT			
SEATING CAPACITY: TOTAL <input type="checkbox"/> FRONT <input type="checkbox"/> REAR <input type="checkbox"/> NOMBRE DE PLACES: TOTAL <input type="checkbox"/> AVANT <input type="checkbox"/> ARRIERE <input type="checkbox"/>			
The combined weight of occupants and cargo should never exceed <input type="checkbox"/> kg or <input type="checkbox"/> lbs. Le poids total des occupants et du chargement ne doit jamais dépasser <input type="checkbox"/> kg ou <input type="checkbox"/> lbs.			
TIRE PNEU	SIZE DIMENSIONS	COLD TIRE PRESSURE PRESSION DES PNEUS A FROID	SEE OWNER'S MANUAL FOR ADDITIONAL INFORMATION
FRONT AVANT	<input type="text"/>	<input type="text"/> kPa <input type="text"/> psi	VOIR LE MANUEL DEL USAGER POUR PLUS DE RENSEIGNEMENTS
REAR ARRIERE	<input type="text"/>	<input type="text"/> kPa <input type="text"/> psi	
SPARE DE SECOURS	<input type="text"/>	<input type="text"/> kPa <input type="text"/> psi	

AF00015489

Vehicle dimensions

N01147501694

Overall length	171.9 in (4,365 mm)
----------------	---------------------

11

Vehicle weights

N01147600858

Gross vehicle weight rating		4,343 lb (1,970 kg)
Gross axle weight rating	Front	2,271 lb (1,030 kg)
	Rear	2,205 lb (1,000 kg)
Vehicle capacity weight		827 lb (375 kg)

Engine specifications

Maximum roof load	176 lb (80 kg)
Seating capacity	5 persons

NOTE

- Roof load is important because it affects the vehicle capacity weight. Refer to “Loading cargo on the roof” on page 6-11.

GVWR: maximum total weight (load) limit specified for the vehicle

GAWR: maximum weight (load) limit specified for the front or rear axle

Seating capacity: the maximum number of occupants

Engine specifications

N01147701537

Item	2.0 liter models	2.4 liter models
Engine model	4B11	4B12
Engine displacement	121.9 CID (1,998 cm ³)	144.0 CID (2,360 cm ³)
No. of cylinders and cylinder arrangement	4 in line	
Bore	3.39 in (86.0 mm)	3.46 in (88.0 mm)
Stroke	3.39 in (86.0 mm)	3.82 in (97.0 mm)
Compression ratio	10.0	10.5
Thermostat valve opening temperature	189 °F (87 °C)	
Spark plugs	NGK DIFR6C11	DIFR5C11
Spark plug gap	.040 to .043 in (1.0 to 1.1 mm)	
Firing order	1-3-4-2	

11

Battery

N01147801336

75D23L

Battery is a 12 volt type.

11-4 Specifications

Tires and wheels

Tires and wheels

N01147901816

Tire		P215/70R16 99H	P225/55R18 97H
Wheel	Size	16 x 6 1/2J	18 x 7J
	PCD	4.5 in (114.3 mm)	
	Off-set	1.81 in (46 mm)	1.50 in (38 mm)

PCD: Pitch Circle Diameter (installation holes)

NOTE

- Contact an authorized Mitsubishi Motors dealer for details on the combination used on your vehicle.
- These tires satisfy vehicle loading conditions described in this owner's manual.

Capacity

N01148002273

Item		Capacity	Lubricants	
Fuel (approximate)	Front-wheel drive vehicles	16.6 gal (63 L)	Refer to "Fuel selection" on page 3-2.	
	All-wheel drive vehicles	15.8 gal (60 L)		
Engine oil	Vehicles with manual trans-axle	Oil pan	Engine oils displaying the ILSAC certification mark ("starburst" symbol) on the container. If these oils are not available, API classification SN or higher can be used.	
		Oil filter		.32 qt (0.3 L)
	Vehicles with continuously variable transmission (CVT)	Oil pan		4.5 qt (4.3 L)
		Oil filter		.32 qt (0.3 L)
Manual transaxle		2.6 qt (2.5 L)	Mitsubishi Motors Genuine NEW MULTI GEAR OIL ECO API GL-4, SAE 75W-80 or Mitsubishi Motors Genuine NEW MULTI GEAR OIL API GL-3, SAE 75W-80	
Continuously variable transmission (CVT)	2.0 liter models	7.3 qt (6.9 L)	Refer to "Continuously variable transmission (CVT) fluid" on page 9-9.	
	2.4 liter models	7.5 qt (7.1 L)		

11

Capacity

Item		Capacity	Lubricants
Transfer oil		.53 qt (0.5 L)	Mitsubishi Motors Genuine Super Hypoid Gear Oil API GL-5 SAE 80
Differential	Rear axle	.42 qt (0.4 L)	Mitsubishi Motors Genuine Super Hypoid Gear Oil API GL-5 SAE 80
Brake/Clutch (if so equipped)		As required	Conforming to Brake fluid DOT3 or DOT4
Hood lock release mechanism and safety catch		As required	Multipurpose type grease NLGI Grade 2
Engine coolant {Includes .69 qt (0.65 L) in reserve tank}		7.9 qt (7.5 L)	Mitsubishi Motors Genuine Super Long Life Coolant Premium or equivalent*
Washer fluid		4.8 qt (4.5 L)	—
Refrigerant (air conditioning)		Refer to the “Air conditioning label” on page 11-2.	HFC-134a

*: similar high quality ethylene glycol based non-silicate, non-amine, non-nitrate and non-borate coolant with long life hybrid organic acid technology

Alphabetical index

Numerics

4-wheel drive operation 5-60

A

Accessory (installation) 3-6

Active stability control (ASC) 5-70

Air bag 4-26

Air cleaner filter 9-8

Air conditioning

Automatic air conditioning 7-9, 7-14

Important air conditioning operating tips..
7-19

Manual air conditioning 7-4

Air purifier 7-20

Aluminum wheels 9-43

Anti-lock braking system 5-67

Arm rest 4-7

Assist grip 5-172

Automatic air conditioning 7-9, 7-14

Automatic High Beam (AHB) 5-143

Automatic transaxle

Fluid 11-5

B

Back-up light

Bulb capacity 9-30

Replacement 9-38

Ball joint, steering linkage seals and drive

shaft boots 9-24

Battery 9-11

Charging system warning light 5-137

Disconnection and connection 9-13

During cold weather 9-13

Specification 11-4

Bottle holder 5-171

Brake

Fluid 11-5

Brake assist system 5-67

Braking 6-5

Anti-lock braking system 5-67

Hose 9-23

Pad wear alarm 5-65

Parking brake 5-40

Pedal 5-64

Pedal free play 9-21

Power brakes 5-64

Service brake 5-64

Warning lights 5-136

Break-in recommendations 5-3

Bulb capacity 9-30

C

California Perchlorate Materials

Requirements 3-6

Capacities 11-5

Card holder 5-158

Cargo area cover 5-171

Cargo loads 6-10

Cargo room light

Bulb capacity 9-32

Catalytic converter 9-2

Cautions on the handling of all-wheel drive
vehicles 5-63

Certification label 11-3

Charging system warning light 5-137

Child restraint systems 4-19

Child safety locks for rear door 5-31

Cleaning

Inside of your vehicle 9-40

Outside of your vehicle 9-41

Clutch

Pedal free play 9-21

Coat hook 5-172

Consumer information 10-2

Continuously variable transmission (CVT) ...
5-51

Fluid 9-9, 11-5

Selector lever operation 5-51

Selector lever positions 5-55

Sports mode 5-56

Coolant (engine) 9-7, 11-5

Cruise control 5-73

Cup holder 5-170

Alphabetical index

D

Daytime running lights
 Bulb capacity 9-30
 Replacement 9-37
 Defogger (rear window) 5-155
 Defrosting or defogging (windshield, door windows)..... 7-8, 7-13, 7-18
 Dimensions 11-3
 Dimmer (high/low beam change) 5-143
 Disc brake pads 9-23
 Dome light
 Bulb capacity 9-32
 Doors
 Lock..... 5-28
 Power door locks 5-30
 Driving during cold weather 6-5
 Driving precaution..... 6-2
 Driving, alcohol and drugs..... 6-2

12

E

Electric rear window defogger switch. 5-155
 Electronic immobilizer (Anti-theft starting system)..... 5-4, 5-23
 Electronically controlled 4WD system.. 5-58
 Emission-control system maintenance .. 9-22
 Engine

12-2

Compartment..... 9-5
 Coolant 9-7, 11-5
 Hood..... 9-3
 Oil and oil filter 9-5, 11-5
 Overheating..... 8-4
 Serial number 11-2
 Specification..... 11-4
 Engine coolant temperature display..... 5-104
 Engine hood 9-3
 Engine switch 5-16
 Exhaust system 9-24

F

Floor console box..... 5-170
 Floor mat..... 6-3
 Fluid
 Automatic transaxle fluid..... 11-5
 Brake fluid 11-5
 Continuously variable transmission (CVT) fluid..... 9-9, 11-5
 Engine coolant..... 9-7, 11-5
 Washer fluid..... 9-10, 11-5
 Fluid capacities and lubricants..... 11-5
 Forward Collision Mitigation system (FCM). 5-78
 Free-hand advanced security transmitter (F.A.S.T.-key) 5-11
 Front fog lights
 Bulb capacity..... 9-30

Indicators 5-135
 Replacement 9-35
 Switch 5-150
 Front seat adjustment 4-3
 Front side-marker lights
 Bulb capacity 9-30
 Replacement 9-34
 Front turn signal light
 Bulb capacity 9-30
 Replacement 9-35
 Fuel
 Filling the fuel tank..... 3-3
 Fuel economy..... 6-2
 Fuel hoses 9-23
 Fuel selection 3-2
 Tank capacity 11-5
 Fuses 9-25
 Fusible links..... 9-25

G

General maintenance
 Maintenance..... 9-23
 General vehicle data..... 11-3
 Genuine parts 3-6
 Glove compartment..... 5-169

H

Hazard warning flasher switch 5-149

Alphabetical index

Hazard warning lights 5-135
 Head restraints..... 4-7
 Headlight leveling switch 5-148
 Headlights
 Bulb capacity 9-30
 Dimmer 5-143
 Headlight flasher 5-143
 Replacement 9-32, 9-33
 Switch 5-139
 High beam indicator..... 5-135
 High-mount stop light
 Bulb capacity 9-30
 Hill start assist..... 5-65
 HomeLink® Wireless Control System 5-159
 Hood lock release mechanism and safety
 catch..... 9-24
 Horn switch..... 5-156

I

If the vehicle breaks down 8-2
 Ignition switch..... 5-46
 Important facts to know in case of an accident
 10-4
 Indicators 5-135
 Information screen display..... 5-95
 Inside rearview mirror 5-42

Inspection and maintenance following rough
 road operation 5-63
 Instrument cluster..... 5-97
 Interior lights 5-165

J

Jack
 Storage..... 8-5
 Jump-starting the engine 8-2

K

Key slot..... 5-22
 Keyless entry system 5-7, 5-25
 Keys 5-3

L

Labeling 11-2
 Lane Departure Warning (LDW) 5-86
 License plate light
 Bulb capacity 9-30
 Replacement 9-39
 Liftgate 5-32
 Inside liftgate release 5-33
 Link System..... 5-156
 Loading information 6-7
 Lubricants 11-5
 Luggage hooks..... 5-173

M

Malfunction indicator light 5-136
 Manual air conditioning..... 7-4
 Manual transaxle..... 5-49
 Oil..... 9-9
 Shift points (recommended speed).... 5-50
 Modification of your vehicle 3-5
 Multi-information display 5-95

O

Octane rating 3-2
 Oil
 Engine oil 9-5, 11-5
 Manual transaxle oil..... 9-9
 Rear axle oil 9-10, 11-5
 Transfer oil 9-9, 11-5
 Operation mode 5-17
 Operation under adverse driving conditions..
 8-14
 Outside rearview mirrors 5-44
 Overheating..... 8-4

P

Parking 6-6
 Parking brake break-in 9-21
 Parking brake lever stroke 9-21
 Parking brake 5-40
 12-3

Alphabetical index

Parking lights (Type 1)
 Bulb capacity 9-30
 Replacement 9-34

Parking lights (Type 2)
 Bulb capacity 9-30
 Replacement 9-37

Polishing 9-43

Power brakes 5-64

Power outlet 5-159

Power windows 5-36

Puncture (Tire changing) 8-6

R

Radio
 General information about your radio 7-20

Reading lights
 Bulb capacity 9-32

Rear axle oil 9-10, 11-5

Rear combination lights
 Bulb capacity 9-30
 Replacement 9-37

Rear side-marker lights
 Bulb capacity 9-30
 Replacement 9-37

Rear turn signal light
 Bulb capacity 9-30
 Replacement 9-37

Rear-view camera 5-93

12-4

Rearview mirror
 Inside rearview mirror 5-42
 Outside rearview mirrors 5-44

Replacement of light bulbs 9-29

Replacing tires and wheels 9-19

Reporting Safety Defects 10-2

S

Safe driving techniques 6-4

Seat belt 4-11
 Adjustable seat belt shoulder anchor . 4-17
 Child restraint systems 4-19
 Front passenger seat belt warning light 4-16
 Maintenance and inspection 4-26
 Seat belt extender 4-17
 Seat belt force limiter 4-19
 Seat belt pre-tensioners 4-17
 Seat belt use during pregnancy 4-17

Seats 4-2
 Arm rest 4-7
 Front seats 4-3
 Head restraints 4-7
 Heated seat 4-6
 Seats and restraint systems 4-2

Service brake 5-64

Service precautions 9-2

Side turn signal light
 Bulb capacity 9-30

Replacement 9-35

Snow tires 9-20

Spark plugs 9-22

Starting the engine 5-47

Steering
 Power steering fluid 11-5
 Steering wheel height and reach adjustment 5-41

Stop lights
 Bulb capacity 9-30
 Replacement 9-37

Storage spaces 5-168

Sun visors 5-158

Sunshade 5-39

Supplemental Restraint System 4-26
 How the Supplemental Restraint System works 4-29
 Maintenance service 4-41

T

Tail light
 Bulb capacity 9-30
 Replacement 9-37

Tank capacity 11-5

Theft-alarm system 5-34

Tire 9-14
 Inflation pressure 9-18
 Maintenance 9-19



Quality grading.....	10-2	Vanity mirror lights	
Replacing tires and wheels.....	9-19	Bulb capacity	9-32
Rotation.....	9-19	Vehicle care precautions	9-39
Size (tire and wheel)	11-5	Vehicle dimensions	11-3
Snow tires	9-20	Vehicle labeling	11-2
To change a tire	8-6	Vehicle preparation before driving	6-4
Tread wear indicator	9-19	Vehicle weights.....	11-3
Tire pressure monitoring system.....	5-89	Vents	7-2
Tires			
Tire and loading information placard	11-2		
Tire chains	9-21		
Tools	8-5		
Storage	8-5		
Towing	8-12		
Trailer towing.....	6-12		
Transfer oil	9-9, 11-5		
Turn signal light			
Indicators.....	5-135		
Lever.....	5-149		

U

USB input terminal	5-156
How to connect an iPod.....	5-157
USB input terminal device	
How to connect a USB memory	5-157

V

Vanity mirror	5-158
---------------------	-------

W

Warning lights	5-136
Washer	
Fluid	9-10, 11-5
Rear window washer	5-154
Switch.....	5-154
Washing	9-41
Waxing	9-42
Weights.....	11-3
Wheel	
Covers.....	8-11
Specification	11-5
Wiper	
Rear window wiper	5-154
Switch.....	5-150
Wiper blades.....	9-22

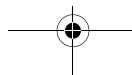
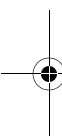
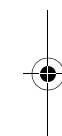



Handwriting practice area consisting of ten horizontal dashed lines.

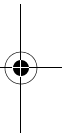
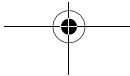
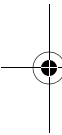

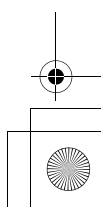
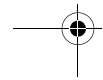
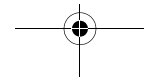
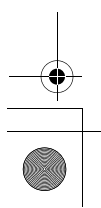
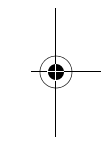
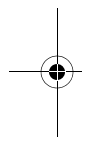
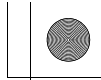
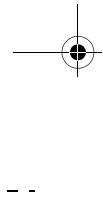
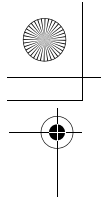

Horizontal dashed lines for text entry



How to calculate your gasoline mileage

You can calculate your miles-per-gallon or kilometers-per-litre by using the following process:

1. Fill your vehicle's fuel tank and record the odometer mileage.
2. Drive your vehicle as you normally do.

3. Refill the fuel tank. Record the odometer mileage again, as well as the gallons/litres of fuel used.
4. Subtract the first mileage number from the second number to know how many miles/kilometers were driven. Divide the number of miles/kilometers driven by the number of gallons/litres of fuel used. This is your approximate miles-per-gallon or kilometers-per-litre.

Gas mileage record

Date	Odometer	Gallons /Litres This Fill	Cost Per Gallon /Litre	Cost This Fill	Miles Per Gallon/Kilometers Per Litre (Miles/Gals.)/(Kilometers/Litres)

Gas mileage record

Date	Odometer	Gallons /Litres This Fill	Cost Per Gallon /Litre	Cost This Fill	Miles Per Gallon/Kilometers Per Litre (Miles/Gals.)/(Kilometers/Litres)

